

**PLEASE CHECK WWW.MOLEX.COM FOR LATEST PART INFORMATION**

**Part Number:** [0009060120](#)  
**Status:** **Active**  
**Overview:** [kk](#)  
**Description:** 3.96mm (.156") KK® IDT Trifurcon™ Contact, 12 Circuits, Tin (Sn), Feed-To, 18 Solid or Fused Stranded, Yellow ID Strip

**Documents:**

[3D Model](#) [Product Specification PS-7660 \(PDF\)](#)  
[Drawing \(PDF\)](#) [RoHS Certificate of Compliance \(PDF\)](#)

**General**

Product Family IDT and Solder Connectors  
 Series [7674](#)  
 Comments Trifurcon™ contact  
 Crimp Quality Equipment Yes  
 Overview [kk](#)  
 Product Name KK®, Trifurcon™

**Physical**

Circuits (Loaded) 12  
 Color - Resin Natural  
 Gender Female  
 Glow-Wire Compliant No  
 Lock to Mating Part Yes  
 Material - Metal Brass  
 Material - Plating Mating Tin  
 Material - Plating Termination Tin  
 Material - Resin Nylon  
 Number of Rows 1  
 Packaging Type Bag  
 Panel Mount No  
 Pitch - Mating Interface (in) 0.156 In  
 Pitch - Mating Interface (mm) 3.96 mm  
 Plating min: Mating (µin) 200  
 Plating min: Mating (µm) 5  
 Plating min: Termination (µin) 200  
 Plating min: Termination (µm) 5  
 Temperature Range - Operating 0°C to +75°C  
 Termination Interface: Style IDT or Pierce  
 Wire Size AWG 18 Solid, 18 Stranded Topcoat

**Electrical**

Voltage - Maximum 250V

**Material Info**

Old Part Number A-7674-D12A102A

**Reference - Drawing Numbers**

Packaging Specification PK-7674-001  
 Product Specification PS-7660  
 Sales Drawing SDA-7674-\*

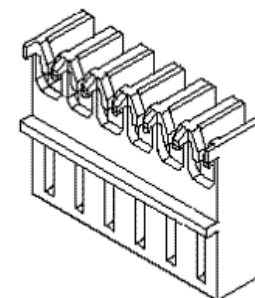

*Series  
image - Reference only*

**EU RoHS**

**ELV and RoHS  
Compliant**  
**REACH SVHC  
Contains SVHC: No  
Halogen-Free  
Status**

**China RoHS**



**Not Reviewed**

**Need more information on product  
environmental compliance?**

Email [productcompliance@molex.com](mailto:productcompliance@molex.com)  
 For a multiple part number RoHS Certificate of Compliance, [click here](#)

Please visit the [Contact Us](#) section for any non-product compliance questions.

**Search Parts in this Series**

[7674Series](#)

**Application Tooling | [FAQ](#)**

*Tooling specifications and manuals are found by selecting the products below. Crimp Height Specifications are then contained in the Application Tooling Specification document.*

**Global**

Description	Product #
Insertion Tool for 3.96mm (.156") Pitch KK® IDT Crimp Terminals	<a href="#">0638133503</a>
IDT - Manual Press For Ribbon Cable	<a href="#">0011200314</a>
IDT - Semi-automatic - Bench-Top Terminator	<a href="#">0011200418</a>
IDT - Manual Handtool	<a href="#">0011215196</a>
IDT Manual Handtool	<a href="#">0621000400</a>

IDT - Semi-automatic 0623000156  
- Bench-Top  
Terminator  
Arbor Press Fixture 0690200770

This document was generated on 05/27/2010

**PLEASE CHECK [WWW.MOLEX.COM](http://WWW.MOLEX.COM) FOR LATEST PART INFORMATION**

6

5

4

3

2

1

## HOUSING TYPE B

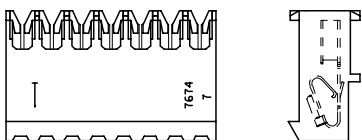

## HOUSING TYPE C

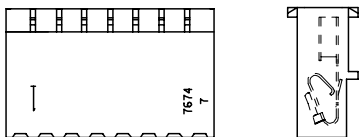

## HOUSING TYPE D

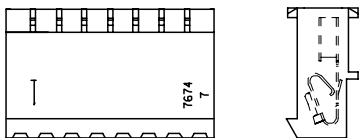

## NOTES:

- MATERIAL: HOUSING - UNFILLED NYLON, UL94V-2.  
TERMINAL - BRASS
- FINISH:
  - 102: .000200/(0.00508) MIN OVERALL TIN OVER  
.000100/(0.00254) MIN COPPER UNDERCOAT.
  - 154: .000100/(0.00254) MIN OVERALL TIN OVER  
.000050/(0.00127) MIN NICKEL UNDERCOAT.
  - 502: .000020/(0.00051) MIN OVERALL GOLD OVER  
.000050/(0.00127) MIN NICKEL UNDERCOAT.
  - 561: .000030/(0.00076) MIN SELECT GOLD OVER  
.000050/(0.00127) MIN NICKEL UNDERCOAT.
- PRODUCT SPECIFICATION: 7660
- PACKAGING: ALL PARTS ARE TO BE BULK PACKED PER PK-7674-001 UNLESS OTHERWISE SPECIFIED IN CHART.
- CHAIN CUTOFF: \*A\* DIMENSION PLUS .010/(0.25).
- COLOR STRIPE TO RUN LENGTH OF RIB AS SHOWN. SEE CHART FOR COLOR OF STRIPE.
- THIS PART CONFORMS TO CLASS B REQUIREMENTS OF COSMETIC SPECIFICATION PS-45499-002.

## HOUSING TYPE

A=7674-AN  
B=7674-BN  
C=7674-CN  
D=7674-DN

A-7674-\*N\*\*-\*-\*

NO. OF CKTS

## PULLED TERMINAL VOIDS

BLANK= NO VOIDS  
NO.= NUMBER CORRESPONDS  
TO CKT. NO. VOIDED,  
MULTIPLE VOIDS  
START WITH 5L

TERMINAL  
A=40936

PLATING  
SEE NOTE 2.

## SLOT SIZE

A= .029/(.74)  
M= .025/(.64)  
L= .022/(.56)  
D= .011/(.28)  
J= .015/(.38)

## HOUSING TYPE A

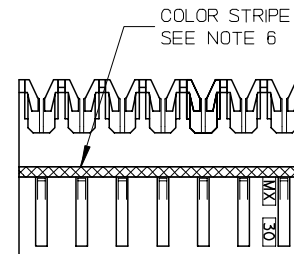
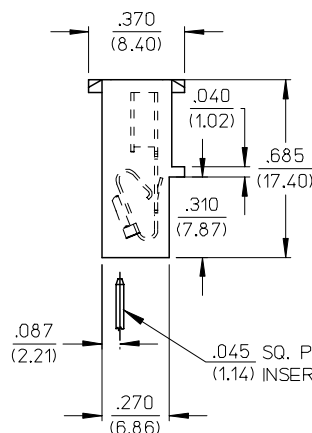
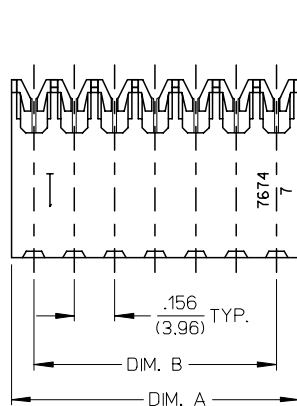

COLOR STRIPE  
SEE NOTE 6

COLOR IDENTIFICATION		TYPE OF WIRE TERMINATED (ALL WIRES HAVE A MAXIMUM INSULATION DIAMETER OF .095/(2.41))
SLOT SIZE	COLOR	
A	YELLOW	#18 GA. SOLID OR FUSED STRANDED
M	RED	#20 GA. SOLID OR FUSED STRANDED & #18 GA. STRANDED
L	BLUE	#20 GA. STRANDED WIRE
D	GREEN	#26 & #27 GA. STRANDED, FUSED STRANDED & SOLID WIRE OR #24 GA. STRANDED WIRE
J	BLACK	#24 & #22 GA. SOLID OR FUSED STRANDED & #22 GA. STRANDED

NO OF CKTS	DIM A	DIM B
2	.330±.007 (8.38±0.18)	.156±.006 (3.96±0.15)
3	.486±.007 (12.34±0.18)	.312±.006 (7.92±0.15)
4	.642±.007 (16.31±0.18)	.468±.006 (11.89±0.15)
5	.798±.008 (20.27±0.20)	.624±.007 (15.85±0.18)
6	.954±.008 (24.23±0.20)	.780±.007 (19.81±0.18)
7	1.110±.009 (28.19±0.23)	.936±.007 (23.77±0.18)
8	1.266±.009 (32.16±0.23)	1.092±.008 (27.74±0.20)
9	1.422±.009 (36.12±0.23)	1.248±.008 (31.70±0.20)
10	1.578±.010 (40.08±0.25)	1.404±.010 (35.66±0.25)
11	1.734±.010 (44.04±0.25)	1.560±.010 (39.62±0.25)
12	1.890±.010 (48.00±0.25)	1.716±.010 (43.59±0.25)
13	2.046±.011 (51.97±0.28)	1.872±.010 (47.55±0.25)
14	2.202±.011 (55.93±0.28)	2.028±.011 (51.51±0.28)
15	2.358±.011 (59.89±0.28)	2.184±.011 (55.47±0.28)
16	2.514±.011 (63.86±0.28)	2.340±.011 (59.44±0.28)

2-*	AC1	GEN DOCS
I	AC2	MICROSTATION
SHEET	REV	DOC STYLE

UPDATE DIM. A & B EC NO: UCP2007-1223 DRWN:PRLODDER 2006/11/28 CHKD:ADERR 2006/11/30 APPR:FSMITH 2006/12/05	DESCRIPTION	QUALITY SYMBOLS	GENERAL TOLERANCES (UNLESS SPECIFIED)		DIMENSION STYLE IN/MM		SCALE	DESIGN UNITS	THIRD ANGLE PROJECTION
		=0 =0	mm	INCH	DRAWN BY	DATE	TITLE  .156 CENTER I.D.T. CONN. ASSY		
			4 PLACES ± --- ± ---	3 PLACES ± --- ± .010	GUZIK	02/12/86			
			2 PLACES ± 0.25 ± .014	1 PLACE ± 0.36 ± ---	EDGLEY	02/12/86			
ANGULAR ± 1/2°	DRAFT WHERE APPLICABLE MUST REMAIN WITHIN DIMENSIONS		APPROVED BY	DATE	MATERIAL NO.	DOCUMENT NO.		SHEET NO.	
AC2	REV	SEE CHART	THIS DRAWING CONTAINS INFORMATION THAT IS PROPRIETARY TO MOLEX INCORPORATED AND SHOULD NOT BE USED WITHOUT WRITTEN PERMISSION		MOLEX INCORPORATED		SDA-7674-*	1 OF 12	

5

4

3

2

1

A-7674-ANA102A		A-7674-BNA102A		A-7674-CNA102A		A-7674-DNA102A	
HOUSING	7674-AN	HOUSING	7674-BN	HOUSING	7674-CN	HOUSING	7674-DN
TERM. NO	40936-A(102)	TERM. NO	40936-A(102)	TERM. NO	40936-A(102)	TERM. NO	40936-A(102)
PLATING:	102	PLATING:	102	PLATING:	102	PLATING:	102
COLOR	YELLOW	COLOR	YELLOW	COLOR	YELLOW	COLOR	YELLOW
MATL NO	ENG NO:	MATL NO	ENG NO:	MATL NO	ENG NO:	MATL NO	ENG NO:
09-07-0029	A-7674-A02A102A	09-06-0029	A-7674-B02A102A	09-07-0020	A-7674-C02A102A	09-06-0020	A-7674-D02A102A
09-07-0039	A-7674-A03A102A	09-06-0039	A-7674-B03A102A	09-07-0030	A-7674-C03A102A	09-06-0030	A-7674-D03A102A
09-07-0049	A-7674-A04A102A	09-06-0049	A-7674-B04A102A	09-07-0040	A-7674-C04A102A	09-06-0040	A-7674-D04A102A
09-07-0059	A-7674-A05A102A	09-06-0059	A-7674-B05A102A	09-07-0050	A-7674-C05A102A	09-06-0050	A-7674-D05A102A
09-07-0069	A-7674-A06A102A	09-06-0069	A-7674-B06A102A	09-07-0060	A-7674-C06A102A	09-06-0060	A-7674-D06A102A
09-07-0079	A-7674-A07A102A	09-06-0079	A-7674-B07A102A	09-07-0070	A-7674-C07A102A	09-06-0070	A-7674-D07A102A
09-07-0089	A-7674-A08A102A	09-06-0089	A-7674-B08A102A	09-07-0080	A-7674-C08A102A	09-06-0080	A-7674-D08A102A
09-07-0099	A-7674-A09A102A	09-06-0099	A-7674-B09A102A	09-07-0090	A-7674-C09A102A	09-06-0090	A-7674-D09A102A
09-07-0109	A-7674-A10A102A	09-06-0109	A-7674-B10A102A	09-07-0100	A-7674-C10A102A	09-06-0100	A-7674-D10A102A
09-07-0119	A-7674-A11A102A	09-06-0119	A-7674-B11A102A	09-07-0110	A-7674-C11A102A	09-06-0110	A-7674-D11A102A
09-07-0129	A-7674-A12A102A	09-06-0129	A-7674-B12A102A	09-07-0120	A-7674-C12A102A	09-06-0120	A-7674-D12A102A
09-07-0139	A-7674-A13A102A	09-06-0139	A-7674-B13A102A	09-07-0130	A-7674-C13A102A	09-06-0130	A-7674-D13A102A
09-07-0149	A-7674-A14A102A	09-06-0149	A-7674-B14A102A	09-07-0140	A-7674-C14A102A	09-06-0140	A-7674-D14A102A
09-07-0159	A-7674-A15A102A	09-06-0159	A-7674-B15A102A	09-07-0150	A-7674-C15A102A	09-06-0150	A-7674-D15A102A
09-07-0169	A-7674-A16A102A	09-06-0169	A-7674-B16A102A	09-07-0160	A-7674-C16A102A	09-06-0160	A-7674-D16A102A
						09-06-0032	A-7674-D03A102A-2
REVISION:	<b>SEE SHEET 1</b> 1/7/2005	TITLE: <b>KK 156 IDT CONNECTOR</b>				SHEET No. <b>2</b>	
DOCUMENT NUMBER:	<b>SDA-7674-*</b>	CREATED / REVISED BY:	<b>J.SCHAFFER 3-10-04</b>	CHECKED BY:	<b>K.SAMIEC 3-15-04</b>	APPROVED BY:	<b>MARGULIS 3-17-04</b>

A-7674-ANM102A		A-7674-BNM102A			A-7674-CNM102A		A-7674-DNM102A		
HOUSING	7674-AN	HOUSING	7674-BN		HOUSING	7674-CN	HOUSING	7674-DN	
TERM. NO	40936-M(102)	TERM. NO	40936-M(102)		TERM. NO	40936-M(102)	TERM. NO	40936-M(102)	
PLATING:	102	PLATING:	102		PLATING:	102	PLATING:	102	
COLOR	RED	COLOR	RED		COLOR	RED	COLOR	RED	
MATL NO	ENG NO:	MATL NO	ENG NO:	VOID	MATL NO	ENG NO:	MATL NO	ENG NO:	VOID
09-07-1029	A-7674-A02M102A	09-06-1029	A-7674-B02M102A		09-07-1020	A-7674-C02M102A	09-06-1020	A-7674-D02M102A	
09-07-1039	A-7674-A03M102A	09-06-1039	A-7674-B03M102A		09-07-1030	A-7674-C03M102A	09-06-1030	A-7674-D03M102A	
09-07-1049	A-7674-A04M102A	09-06-1049	A-7674-B04M102A		09-07-1040	A-7674-C04M102A	09-06-1040	A-7674-D04M102A	
09-07-1059	A-7674-A05M102A	09-06-1059	A-7674-B05M102A		09-07-1050	A-7674-C05M102A	09-06-1050	A-7674-D05M102A	
09-07-1069	A-7674-A06M102A	09-06-1069	A-7674-B06M102A		09-07-1060	A-7674-C06M102A	09-06-1060	A-7674-D06M102A	
09-07-1079	A-7674-A07M102A	09-06-1079	A-7674-B07M102A		09-07-1070	A-7674-C07M102A	09-06-1070	A-7674-D07M102A	
09-07-1089	A-7674-A08M102A	09-06-1089	A-7674-B08M102A		09-07-1080	A-7674-C08M102A	09-06-1080	A-7674-D08M102A	
09-07-1099	A-7674-A09M102A	09-06-1099	A-7674-B09M102A		09-07-1090	A-7674-C09M102A	09-06-1090	A-7674-D09M102A	
09-07-1109	A-7674-A10M102A	09-06-1109	A-7674-B10M102A		09-07-1100	A-7674-C10M102A	09-06-1100	A-7674-D10M102A	
09-07-1119	A-7674-A11M102A	09-06-1119	A-7674-B11M102A		09-07-1110	A-7674-C11M102A	09-06-1110	A-7674-D11M102A	
09-07-1129	A-7674-A12M102A	09-06-1129	A-7674-B12M102A		09-07-1120	A-7674-C12M102A	09-06-1120	A-7674-D12M102A	
09-07-1139	A-7674-A13M102A	09-06-1139	A-7674-B13M102A		09-07-1130	A-7674-C13M102A	09-06-1130	A-7674-D13M102A	
09-07-1149	A-7674-A14M102A	09-06-1149	A-7674-B14M102A		09-07-1140	A-7674-C14M102A	09-06-1140	A-7674-D14M102A	
09-07-1159	A-7674-A15M102A	09-06-1159	A-7674-B15M102A		09-07-1150	A-7674-C15M102A	09-06-1150	A-7674-D15M102A	
09-07-1169	A-7674-A16M102A	09-06-1169	A-7674-B16M102A		09-07-1160	A-7674-C16M102A	09-06-1160	A-7674-D16M102A	
		50-29-1592	A-7674-B03M102A-2	2			50-29-1591	A-7674-D03M102A-2	2

REVISION: <b>AC1</b>	<b>SEE SHEET 1 1/7/2005</b>	TITLE: <b>KK 156 IDT CONNECTOR</b>	SHEET No. <b>3</b>
DOCUMENT NUMBER: <b>SDA-7674-*</b>	CREATED / REVISED BY: <b>J.SCHAFFER 3-10-04</b>	CHECKED BY: <b>K.SAMIEC 3-15-04</b>	APPROVED BY: <b>MARGULIS 3-17-04</b>

A-7674-ANL102A		A-7674-BNL102A		A-7674-CNL102A		A-7674-DNL102A		
HOUSING	7674-AN	HOUSING	7674-BN	HOUSING	7674-CN	HOUSING	7674-DN	
TERM. NO	40936-L(102)	TERM. NO	40936-L(102)	TERM. NO	40936-L(102)	TERM. NO	40936-L(102)	
PLATING:	102	PLATING:	102	PLATING:	102	PLATING:	102	
COLOR	BLUE	COLOR	BLUE	COLOR	BLUE	COLOR	BLUE	
MATL NO	ENG NO:	MATL NO	ENG NO:	MATL NO	ENG NO:	MATL NO	ENG NO:	
09-07-2029	A-7674-A02L102A	09-06-2029	A-7674-B02L102A	09-07-2020	A-7674-C02L102A	09-06-2020	A-7674-D02L102A	
09-07-2039	A-7674-A03L102A	09-06-2039	A-7674-B03L102A	09-07-2030	A-7674-C03L102A	09-06-2030	A-7674-D03L102A	
09-07-2049	A-7674-A04L102A	09-06-2049	A-7674-B04L102A	09-07-2040	A-7674-C04L102A	09-06-2040	A-7674-D04L102A	
09-07-2059	A-7674-A05L102A	09-06-2059	A-7674-B05L102A	09-07-2050	A-7674-C05L102A	09-06-2050	A-7674-D05L102A	
09-07-2069	A-7674-A06L102A	09-06-2069	A-7674-B06L102A	09-07-2060	A-7674-C06L102A	09-06-2060	A-7674-D06L102A	
09-07-2079	A-7674-A07L102A	09-06-2079	A-7674-B07L102A	09-07-2070	A-7674-C07L102A	09-06-2070	A-7674-D07L102A	
09-07-2089	A-7674-A08L102A	09-06-2089	A-7674-B08L102A	09-07-2080	A-7674-C08L102A	09-06-2080	A-7674-D08L102A	
09-07-2099	A-7674-A09L102A	09-06-2099	A-7674-B09L102A	09-07-2090	A-7674-C09L102A	09-06-2090	A-7674-D09L102A	
09-07-2109	A-7674-A10L102A	09-06-2109	A-7674-B10L102A	09-07-2100	A-7674-C10L102A	09-06-2100	A-7674-D10L102A	
09-07-2119	A-7674-A11L102A	09-06-2119	A-7674-B11L102A	09-07-2110	A-7674-C11L102A	09-06-2110	A-7674-D11L102A	
09-07-2129	A-7674-A12L102A	09-06-2129	A-7674-B12L102A	09-07-2120	A-7674-C12L102A	09-06-2120	A-7674-D12L102A	
09-07-2139	A-7674-A13L102A	09-06-2139	A-7674-B13L102A	09-07-2130	A-7674-C13L102A	09-06-2130	A-7674-D13L102A	
09-07-2149	A-7674-A14L102A	09-06-2149	A-7674-B14L102A	09-07-2140	A-7674-C14L102A	09-06-2140	A-7674-D14L102A	
09-07-2159	A-7674-A15L102A	09-06-2159	A-7674-B15L102A	09-07-2150	A-7674-C15L102A	09-06-2150	A-7674-D15L102A	
09-07-2169	A-7674-A16L102A	09-06-2169	A-7674-B16L102A	09-07-2160	A-7674-C16L102A	09-06-2160	A-7674-D16L102A	
REVISION:	<b>SEE SHEET 1</b> 1/7/2005	TITLE:	<b>KK 156 IDT CONNECTOR</b>				SHEET No.	
<b>AC1</b>							<b>4</b>	
DOCUMENT NUMBER:		CREATED / REVISED BY:	CHECKED BY:	APPROVED BY:				
<b>SDA-7674-*</b>		<b>J.SCHAFFER 3-10-04</b>	<b>K.SAMIEC 3-15-04</b>	<b>MARGULIS 3-17-04</b>				

A-7674-AND102A		A-7674-BND102A		A-7674-CND102A		A-7674-DND102A		
HOUSING	7674-AN	HOUSING	7674-BN	HOUSING	7674-CN	HOUSING	7674-DN	
TERM. NO	40936-D(102)	TERM. NO	40936-D(102)	TERM. NO	40936-D(102)	TERM. NO	40936-D(102)	
PLATING:	102	PLATING:	102	PLATING:	102	PLATING:	102	
COLOR	GREEN	COLOR	GREEN	COLOR	GREEN	COLOR	GREEN	
MATL NO	ENG NO:	MATL NO	ENG NO:	MATL NO	ENG NO:	MATL NO	ENG NO:	
09-07-3029	A-7674-A02D102A	09-06-3029	A-7674-B02D102A	09-07-3020	A-7674-C02D102A	09-06-3020	A-7674-D02D102A	
09-07-3039	A-7674-A03D102A	09-06-3039	A-7674-B03D102A	09-07-3030	A-7674-C03D102A	09-06-3030	A-7674-D03D102A	
09-07-3049	A-7674-A04D102A	09-06-3049	A-7674-B04D102A	09-07-3040	A-7674-C04D102A	09-06-3040	A-7674-D04D102A	
09-07-3059	A-7674-A05D102A	09-06-3059	A-7674-B05D102A	09-07-3050	A-7674-C05D102A	09-06-3050	A-7674-D05D102A	
09-07-3069	A-7674-A06D102A	09-06-3069	A-7674-B06D102A	09-07-3060	A-7674-C06D102A	09-06-3060	A-7674-D06D102A	
09-07-3079	A-7674-A07D102A	09-06-3079	A-7674-B07D102A	09-07-3070	A-7674-C07D102A	09-06-3070	A-7674-D07D102A	
09-07-3089	A-7674-A08D102A	09-06-3089	A-7674-B08D102A	09-07-3080	A-7674-C08D102A	09-06-3080	A-7674-D08D102A	
09-07-3099	A-7674-A09D102A	09-06-3099	A-7674-B09D102A	09-07-3090	A-7674-C09D102A	09-06-3090	A-7674-D09D102A	
09-07-3109	A-7674-A10D102A	09-06-3109	A-7674-B10D102A	09-07-3100	A-7674-C10D102A	09-06-3100	A-7674-D10D102A	
09-07-3119	A-7674-A11D102A	09-06-3119	A-7674-B11D102A	09-07-3110	A-7674-C11D102A	09-06-3110	A-7674-D11D102A	
09-07-3129	A-7674-A12D102A	09-06-3129	A-7674-B12D102A	09-07-3120	A-7674-C12D102A	09-06-3120	A-7674-D12D102A	
09-07-3139	A-7674-A13D102A	09-06-3139	A-7674-B13D102A	09-07-3130	A-7674-C13D102A	09-06-3130	A-7674-D13D102A	
09-07-3149	A-7674-A14D102A	09-06-3149	A-7674-B14D102A	09-07-3140	A-7674-C14D102A	09-06-3140	A-7674-D14D102A	
09-07-3159	A-7674-A15D102A	09-06-3159	A-7674-B15D102A	09-07-3150	A-7674-C15D102A	09-06-3150	A-7674-D15D102A	
09-07-3169	A-7674-A16D102A	09-06-3169	A-7674-B16D102A	09-07-3160	A-7674-C16D102A	09-06-3160	A-7674-D16D102A	
REVISION:	<b>SEE SHEET 1</b> 1/7/2005	TITLE:	<b>KK 156 IDT CONNECTOR</b>				SHEET No. <b>5</b>	
<b>AC1</b>								
DOCUMENT NUMBER:	<b>SDA-7674-*</b>		CREATED / REVISED BY:	<b>J.SCHAFFER 3-10-04</b>		CHECKED BY:	<b>K.SAMIEC 3-15-04</b>	
						APPROVED BY:	<b>MARGULIS 3-17-04</b>	

A-7674-ANJ102A		A-7674-BNJ102A		A-7674-CNJ102A			A-7674-DNJ102A	
HOUSING	7674-AN	HOUSING	7674-BN	HOUSING	7674-CN		HOUSING	7674-DN
TERM. NO	40936-J(102)	TERM. NO	40936-J(102)	TERM. NO	40936-J(102)		TERM. NO	40936-J(102)
PLATING:	102	PLATING:	102	PLATING:	102		PLATING:	102
COLOR	BLACK	COLOR	BLACK	COLOR	BLACK		COLOR	BLACK
MATL NO	ENG NO:	MATL NO	ENG NO:	MATL NO	ENG NO:	VOID	MATL NO	ENG NO:
09-07-5029	A-7674-A02J102A	09-06-5029	A-7674-B02J102A	09-07-5020	A-7674-C02J102A		09-06-5020	A-7674-D02J102A
09-07-5039	A-7674-A03J102A	09-06-5039	A-7674-B03J102A	09-07-5030	A-7674-C03J102A		09-06-5030	A-7674-D03J102A
09-07-5049	A-7674-A04J102A	09-06-5049	A-7674-B04J102A	09-07-5040	A-7674-C04J102A		09-06-5040	A-7674-D04J102A
09-07-5059	A-7674-A05J102A	09-06-5059	A-7674-B05J102A	09-07-5050	A-7674-C05J102A		09-06-5050	A-7674-D05J102A
09-07-5069	A-7674-A06J102A	09-06-5069	A-7674-B06J102A	09-07-5060	A-7674-C06J102A		09-06-5060	A-7674-D06J102A
09-07-5079	A-7674-A07J102A	09-06-5079	A-7674-B07J102A	09-07-5070	A-7674-C07J102A		09-06-5070	A-7674-D07J102A
09-07-5089	A-7674-A08J102A	09-06-5089	A-7674-B08J102A	09-07-5080	A-7674-C08J102A		09-06-5080	A-7674-D08J102A
09-07-5099	A-7674-A09J102A	09-06-5099	A-7674-B09J102A	09-07-5090	A-7674-C09J102A		09-06-5090	A-7674-D09J102A
09-07-5109	A-7674-A10J102A	09-06-5109	A-7674-B10J102A	09-07-5100	A-7674-C10J102A		09-06-5100	A-7674-D10J102A
09-07-5119	A-7674-A11J102A	09-06-5119	A-7674-B11J102A	09-07-5110	A-7674-C11J102A		09-06-5110	A-7674-D11J102A
09-07-5129	A-7674-A12J102A	09-06-5129	A-7674-B12J102A	09-07-5120	A-7674-C12J102A		09-06-5120	A-7674-D12J102A
09-07-5139	A-7674-A13J102A	09-06-5139	A-7674-B13J102A	09-07-5130	A-7674-C13J102A		09-06-5130	A-7674-D13J102A
09-07-5149	A-7674-A14J102A	09-06-5149	A-7674-B14J102A	09-07-5140	A-7674-C14J102A		09-06-5140	A-7674-D14J102A
09-07-5159	A-7674-A15J102A	09-06-5159	A-7674-B15J102A	09-07-5150	A-7674-C15J102A		09-06-5150	A-7674-D15J102A
09-07-5169	A-7674-A16J102A	09-06-5169	A-7674-B16J102A	09-07-5160	A-7674-C16J102A		09-06-5160	A-7674-D16J102A
				09-10-2156	A-7674-C15J102A-51	2,4,6,8, 10,12, 14		
				09-10-2117	A-7674-C11J102A-51	2,4,6,8, 10		
REVISION:	<b>AC1</b>	TITLE:	<b>KK 156 IDT CONNECTOR</b>				SHEET No.	<b>6</b>
		<b>SEE SHEET 1 1/7/2005</b>						
DOCUMENT NUMBER:	<b>SDA-7674-*</b>	CREATED / REVISED BY:	<b>J.SCHAFFER 3-10-04</b>	CHECKED BY:	<b>K.SAMIEC 3-15-04</b>	APPROVED BY:	<b>MARGULIS 3-17-04</b>	



A-7674-ANA502A		A-7674-BNA502A		A-7674-CNA502A		A-7674-DNA502A		
HOUSING	7674-AN	HOUSING	7674-BN	HOUSING	7674-CN	HOUSING	7674-DN	
TERM. NO	40936-A(502)	TERM. NO	40936-A(502)	TERM. NO	40936-A(502)	TERM. NO	40936-A(502)	
PLATING:	502	PLATING:	502	PLATING:	502	PLATING:	502	
COLOR	YELLOW	COLOR	YELLOW	COLOR	YELLOW	COLOR	YELLOW	
MATL NO	ENG NO:	MATL NO	ENG NO:	MATL NO	ENG NO:	MATL NO	ENG NO:	
	A-7674-A02A502A		A-7674-B02A502A		A-7674-C02A502A	26-32-4024	A-7674-D02A502A	
	A-7674-A03A502A		A-7674-B03A502A		A-7674-C03A502A	26-32-4034	A-7674-D03A502A	
	A-7674-A04A502A		A-7674-B04A502A		A-7674-C04A502A	26-32-4044	A-7674-D04A502A	
	A-7674-A05A502A		A-7674-B05A502A		A-7674-C05A502A	26-32-4054	A-7674-D05A502A	
	A-7674-A06A502A		A-7674-B06A502A		A-7674-C06A502A	26-32-4064	A-7674-D06A502A	
	A-7674-A07A502A		A-7674-B07A502A		A-7674-C07A502A	26-32-4074	A-7674-D07A502A	
	A-7674-A08A502A		A-7674-B08A502A		A-7674-C08A502A	26-32-4084	A-7674-D08A502A	
	A-7674-A09A502A		A-7674-B09A502A		A-7674-C09A502A	26-32-4094	A-7674-D09A502A	
	A-7674-A10A502A		A-7674-B10A502A		A-7674-C10A502A	26-32-4104	A-7674-D10A502A	
	A-7674-A11A502A		A-7674-B11A502A		A-7674-C11A502A	26-32-4114	A-7674-D11A502A	
	A-7674-A12A502A		A-7674-B12A502A		A-7674-C12A502A	26-32-4124	A-7674-D12A502A	
	A-7674-A13A502A		A-7674-B13A502A		A-7674-C13A502A	26-32-4134	A-7674-D13A502A	
	A-7674-A14A502A		A-7674-B14A502A		A-7674-C14A502A	26-32-4144	A-7674-D14A502A	
	A-7674-A15A502A		A-7674-B15A502A		A-7674-C15A502A	26-32-4154	A-7674-D15A502A	
	A-7674-A16A502A		A-7674-B16A502A		A-7674-C16A502A	26-32-4164	A-7674-D16A502A	
REVISION:	<b>AC1</b>	TITLE:	<b>KK 156 IDT CONNECTOR</b>				SHEET No.	<b>7</b>
		<b>SEE SHEET 1 1/7/2005</b>						
DOCUMENT NUMBER:	<b>SDA-7674-*</b>	CREATED / REVISED BY:	<b>J.SCHAFFER 3-10-04</b>	CHECKED BY:	<b>K.SAMIEC 3-15-04</b>	APPROVED BY:	<b>MARGULIS 3-17-04</b>	

A-7674-ANM502A		A-7674-BNM502A		A-7674-CNM502A		A-7674-DNM502A		
HOUSING	7674-AN	HOUSING	7674-BN	HOUSING	7674-CN	HOUSING	7674-DN	
TERM. NO	40936-M(502)	TERM. NO	40936-M(502)	TERM. NO	40936-M(502)	TERM. NO	40936-M(502)	
PLATING:	502	PLATING:	502	PLATING:	502	PLATING:	502	
COLOR	RED	COLOR	RED	COLOR	RED	COLOR	RED	
MATL NO	ENG NO:	MATL NO	ENG NO:	MATL NO	ENG NO:	MATL NO	ENG NO:	
	A-7674-A02M502A		A-7674-B02M502A		A-7674-C02M502A		A-7674-D02M502A	
	A-7674-A03M502A		A-7674-B03M502A		A-7674-C03M502A	26-32-6034	A-7674-D03M502A	
	A-7674-A04M502A		A-7674-B04M502A		A-7674-C04M502A	26-32-6044	A-7674-D04M502A	
	A-7674-A05M502A		A-7674-B05M502A		A-7674-C05M502A		A-7674-D05M502A	
	A-7674-A06M502A		A-7674-B06M502A		A-7674-C06M502A	26-32-6064	A-7674-D06M502A	
	A-7674-A07M502A		A-7674-B07M502A		A-7674-C07M502A	26-32-6074	A-7674-D07M502A	
	A-7674-A08M502A		A-7674-B08M502A		A-7674-C08M502A		A-7674-D08M502A	
	A-7674-A09M502A		A-7674-B09M502A		A-7674-C09M502A		A-7674-D09M502A	
	A-7674-A10M502A		A-7674-B10M502A		A-7674-C10M502A	26-32-6104	A-7674-D10M502A	
	A-7674-A11M502A	26-32-4111	A-7674-B11M502A		A-7674-C11M502A		A-7674-D11M502A	
	A-7674-A12M502A		A-7674-B12M502A		A-7674-C12M502A		A-7674-D12M502A	
	A-7674-A13M502A		A-7674-B13M502A		A-7674-C13M502A		A-7674-D13M502A	
	A-7674-A14M502A		A-7674-B14M502A		A-7674-C14M502A		A-7674-D14M502A	
	A-7674-A15M502A		A-7674-B15M502A		A-7674-C15M502A		A-7674-D15M502A	
	A-7674-A16M502A		A-7674-B16M502A		A-7674-C16M502A		A-7674-D16M502A	
REVISION:	<b>AC1</b>	TITLE:	<b>KK 156 IDT CONNECTOR</b>				SHEET No.	
		<b>SEE SHEET 1 1/7/2005</b>						<b>8</b>
DOCUMENT NUMBER:	<b>SDA-7674-*</b>	CREATED / REVISED BY:	<b>J.SCHAFFER 3-10-04</b>	CHECKED BY:	<b>K.SAMIEC 3-15-04</b>	APPROVED BY:	<b>MARGULIS 3-17-04</b>	

A-7674-ANL502A		A-7674-BNL502A		A-7674-CNL502A		A-7674-DNL502A	
HOUSING	7674-AN	HOUSING	7674-BN	HOUSING	7674-CN	HOUSING	7674-DN
TERM. NO	40936-L(502)	TERM. NO	40936-L(502)	TERM. NO	40936-L(502)	TERM. NO	40936-L(502)
PLATING:	502	PLATING:	502	PLATING:	502	PLATING:	502
COLOR	BLUE	COLOR	BLUE	COLOR	BLUE	COLOR	BLUE
MATL NO	ENG NO:	MATL NO	ENG NO:	MATL NO	ENG NO:	MATL NO	ENG NO:
26-32-2024	A-7674-A02L502A		A-7674-B02L502A		A-7674-C02L502A	26-32-2022	A-7674-D02L502A
26-32-2034	A-7674-A03L502A		A-7674-B03L502A		A-7674-C03L502A	26-32-2032	A-7674-D03L502A
26-32-2044	A-7674-A04L502A		A-7674-B04L502A		A-7674-C04L502A	26-32-2042	A-7674-D04L502A
26-32-2054	A-7674-A05L502A		A-7674-B05L502A		A-7674-C05L502A	26-32-2052	A-7674-D05L502A
26-32-2064	A-7674-A06L502A		A-7674-B06L502A		A-7674-C06L502A	26-32-2062	A-7674-D06L502A
26-32-2074	A-7674-A07L502A		A-7674-B07L502A		A-7674-C07L502A	26-32-2072	A-7674-D07L502A
26-32-2084	A-7674-A08L502A		A-7674-B08L502A		A-7674-C08L502A	26-32-2082	A-7674-D08L502A
26-32-2094	A-7674-A09L502A		A-7674-B09L502A		A-7674-C09L502A	26-32-2092	A-7674-D09L502A
26-32-2104	A-7674-A10L502A		A-7674-B10L502A		A-7674-C10L502A	26-32-2102	A-7674-D10L502A
26-32-2114	A-7674-A11L502A		A-7674-B11L502A		A-7674-C11L502A	26-32-2112	A-7674-D11L502A
26-32-2124	A-7674-A12L502A		A-7674-B12L502A		A-7674-C12L502A	26-32-2122	A-7674-D12L502A
26-32-2134	A-7674-A13L502A		A-7674-B13L502A		A-7674-C13L502A	26-32-2132	A-7674-D13L502A
26-32-2144	A-7674-A14L502A		A-7674-B14L502A		A-7674-C14L502A	26-32-2142	A-7674-D14L502A
26-32-2154	A-7674-A15L502A		A-7674-B15L502A		A-7674-C15L502A	26-32-2152	A-7674-D15L502A
26-32-2164	A-7674-A16L502A		A-7674-B16L502A		A-7674-C16L502A	26-32-2162	A-7674-D16L502A

REVISION:	<b>SEE SHEET 1</b> 1/7/2005	TITLE:	<b>KK 156 IDT CONNECTOR</b>	SHEET No.	<b>9</b>
DOCUMENT NUMBER:	<b>SDA-7674-*</b>	CREATED / REVISED BY:	<b>J.SCHAFFER 3-10-04</b>	CHECKED BY:	<b>K.SAMIEC 3-15-04</b>
				APPROVED BY:	<b>MARGULIS 3-17-04</b>

A-7674-ANJ502A		A-7674-BNJ502A		A-7674-CNJ502A		A-7674-DNJ502A		
HOUSING	7674-AN	HOUSING	7674-BN	HOUSING	7674-CN	HOUSING	7674-DN	
TERM. NO	40936-J(502)	TERM. NO	40936-J(502)	TERM. NO	40936-J(502)	TERM. NO	40936-J(502)	
PLATING:	502	PLATING:	502	PLATING:	502	PLATING:	502	
COLOR	BLACK	COLOR	BLACK	COLOR	BLACK	COLOR	BLACK	
MATL NO	ENG NO:	MATL NO	ENG NO:	MATL NO	ENG NO:	MATL NO	ENG NO:	
	A-7674-A02J502A	26-32-1027	A-7674-B02J502A		A-7674-C02J502A	26-32-1025	A-7674-D02J502A	
	A-7674-A03J502A	26-32-1037	A-7674-B03J502A		A-7674-C03J502A	26-32-1035	A-7674-D03J502A	
	A-7674-A04J502A	26-32-1047	A-7674-B04J502A		A-7674-C04J502A	26-32-1049	A-7674-D04J502A	
	A-7674-A05J502A	26-32-1057	A-7674-B05J502A		A-7674-C05J502A	26-32-1059	A-7674-D05J502A	
	A-7674-A06J502A	26-32-1067	A-7674-B06J502A	26-32-1063	A-7674-C06J502A	26-32-1069	A-7674-D06J502A	
	A-7674-A07J502A	26-32-1077	A-7674-B07J502A		A-7674-C07J502A	26-32-1079	A-7674-D07J502A	
	A-7674-A08J502A	26-32-1087	A-7674-B08J502A		A-7674-C08J502A	26-32-1089	A-7674-D08J502A	
	A-7674-A09J502A	26-32-1097	A-7674-B09J502A		A-7674-C09J502A	26-32-1099	A-7674-D09J502A	
	A-7674-A10J502A	26-32-1107	A-7674-B10J502A		A-7674-C10J502A	26-32-1109	A-7674-D10J502A	
	A-7674-A11J502A	26-32-1117	A-7674-B11J502A		A-7674-C11J502A	26-32-1119	A-7674-D11J502A	
	A-7674-A12J502A	26-32-1127	A-7674-B12J502A		A-7674-C12J502A	26-32-1129	A-7674-D12J502A	
	A-7674-A13J502A	26-32-1137	A-7674-B13J502A		A-7674-C13J502A	26-32-1139	A-7674-D13J502A	
	A-7674-A14J502A	26-32-1147	A-7674-B14J502A		A-7674-C14J502A	26-32-1149	A-7674-D14J502A	
	A-7674-A15J502A	26-32-1157	A-7674-B15J502A		A-7674-C15J502A	26-32-1159	A-7674-D15J502A	
	A-7674-A16J502A	26-32-1167	A-7674-B16J502A		A-7674-C16J502A	26-32-1169	A-7674-D16J502A	
REVISION:	<b>AC1</b>	TITLE:	<b>KK 156 IDT CONNECTOR</b>				SHEET No.	<b>10</b>
		<b>SEE SHEET 1 1/7/2005</b>						
DOCUMENT NUMBER:	<b>SDA-7674-*</b>	CREATED / REVISED BY:	<b>J.SCHAFFER 3-10-04</b>	CHECKED BY:	<b>K.SAMIEC 3-15-04</b>	APPROVED BY:	<b>MARGULIS 3-17-04</b>	

A-7674-ANJ561A		A-7674-BNJ561A		A-7674-CNJ561A		A-7674-DNJ561A		
HOUSING	7674-AN	HOUSING	7674-BN	HOUSING	7674-CN	HOUSING	7674-DN	
TERM. NO	40936-J(561)	TERM. NO	40936-J(561)	TERM. NO	40936-J(561)	TERM. NO	40936-J(561)	
PLATING:	561	PLATING:	561	PLATING:	561	PLATING:	561	
COLOR	BLACK	COLOR	BLACK	COLOR	BLACK	COLOR	BLACK	
MATL NO	ENG NO:	MATL NO	ENG NO:	MATL NO	ENG NO:	MATL NO	ENG NO:	
	A-7674-A02J561A		A-7674-B02J561A		A-7674-C02J561A		A-7674-D02J561A	
	A-7674-A03J561A		A-7674-B03J561A		A-7674-C03J561A		A-7674-D03J561A	
	A-7674-A04J561A		A-7674-B04J561A		A-7674-C04J561A		A-7674-D04J561A	
	A-7674-A05J561A		A-7674-B05J561A		A-7674-C05J561A		A-7674-D05J561A	
	A-7674-A06J561A		A-7674-B06J561A		A-7674-C06J561A		A-7674-D06J561A	
	A-7674-A07J561A		A-7674-B07J561A		A-7674-C07J561A		A-7674-D07J561A	
	A-7674-A08J561A		A-7674-B08J561A		A-7674-C08J561A		A-7674-D08J561A	
	A-7674-A09J561A		A-7674-B09J561A		A-7674-C09J561A		A-7674-D09J561A	
	A-7674-A10J561A		A-7674-B10J561A		A-7674-C10J561A		A-7674-D10J561A	
	A-7674-A11J561A		A-7674-B11J561A		A-7674-C11J561A		A-7674-D11J561A	
	A-7674-A12J561A		A-7674-B12J561A		A-7674-C12J561A		A-7674-D12J561A	
	A-7674-A13J561A		A-7674-B13J561A		A-7674-C13J561A		A-7674-D13J561A	
	A-7674-A14J561A		A-7674-B14J561A		A-7674-C14J561A		A-7674-D14J561A	
	A-7674-A15J561A		A-7674-B15J561A		A-7674-C15J561A		A-7674-D15J561A	
	A-7674-A16J561A		A-7674-B16J561A		A-7674-C16J561A	50-29-1556	A-7674-D16J561A	
REVISION:	<b>AC1</b>	TITLE:				<b>SEE SHEET 1 1/7/2005</b>		SHEET No.
		<b>KK 156 IDT CONNECTOR</b>						<b>11</b>
DOCUMENT NUMBER:		CREATED / REVISED BY:		CHECKED BY:		APPROVED BY:		
<b>SDA-7674-*</b>		<b>J.SCHAFFER 3-10-04</b>		<b>K.SAMIEC 3-15-04</b>		<b>MARGULIS 3-17-04</b>		

A-7674-ANM154A		A-7674-BNM154A		A-7674-CNM154A		A-7674-DNM154A	
HOUSING	7674-AN	HOUSING	7674-BN	HOUSING	7674-CN	HOUSING	7674-DN
TERM. NO	40936-M(154)	TERM. NO	40936-M(154)	TERM. NO	40936-M(154)	TERM. NO	40936-M(154)
PLATING:	154	PLATING:	154	PLATING:	154	PLATING:	154
COLOR	RED	COLOR	RED	COLOR	RED	COLOR	RED
MATL NO	ENG NO:	MATL NO	ENG NO:	MATL NO	ENG NO:	MATL NO	ENG NO:
				50-29-1972	A-7674-C02M154A	50-29-1987	A-7674-D02M154A
				50-29-1973	A-7674-C03M154A	50-29-1988	A-7674-D03M154A
				50-29-1974	A-7674-C04M154A	50-29-1989	A-7674-D04M154A
				50-29-1975	A-7674-C05M154A	50-29-1990	A-7674-D05M154A
				50-29-1976	A-7674-C06M154A	50-29-1991	A-7674-D06M154A
				50-29-1977	A-7674-C07M154A	50-29-1992	A-7674-D07M154A
				50-29-1978	A-7674-C08M154A	50-29-1993	A-7674-D08M154A
				50-29-1979	A-7674-C09M154A	50-29-1994	A-7674-D09M154A
				50-29-1980	A-7674-C10M154A	50-29-1995	A-7674-D10M154A
				50-29-1981	A-7674-C11M154A	50-29-1996	A-7674-D11M154A
				50-29-1982	A-7674-C12M154A	50-29-1997	A-7674-D12M154A
				50-29-1983	A-7674-C13M154A	50-29-1998	A-7674-D13M154A
				50-29-1984	A-7674-C14M154A	50-29-1999	A-7674-D14M154A
				50-29-1985	A-7674-C15M154A	50-29-2000	A-7674-D15M154A
				50-29-1986	A-7674-C16M154A	50-29-2001	A-7674-D16M154A



REVISION: <b>AC1</b>	SEE SHEET 1 1/7/2005	TITLE: <b>KK 156 IDT CONNECTOR</b>	SHEET No. <b>12</b>
-------------------------	-------------------------	---------------------------------------	------------------------

DOCUMENT NUMBER: <b>SDA-7674-*</b>	CREATED / REVISED BY: <b>J.SCHAFFER 3-10-04</b>	CHECKED BY: <b>K.SAMIEC 3-15-04</b>	APPROVED BY: <b>MARGULIS 3-17-04</b>
---------------------------------------	--	--	---