

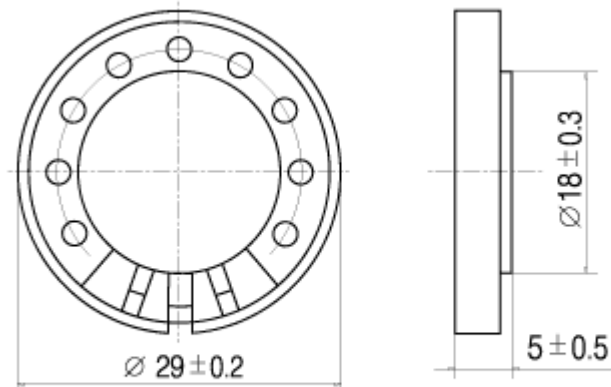

Type	BMS-2911
Rated Impedance(Ω)	16 \pm 15%
Rated(Max.) Power(W)	0.1(0.2)
Resonant Frequency(Hz)	550 \pm 20%
Rated Freq.Range(Hz)	f ₀ ~3500
Sound Pressure Level(dB)	80 \pm 3
Magnet(g)	1.1
Operating Temperature($^{\circ}$ C)	-10~+40



Unit:mm

