

## NON-ISOLATED DC/DC CONVERTERS

6.0 Vdc - 13.2 Vdc Input, 0.5 Vdc - 1.6 Vdc Output, VRM11.1 Compatible



Aug. 13, 2010

*Bel Power Inc., a subsidiary of Bel Fuse Inc.*

**VRP4-CxE1A0**

**RoHS Compliant**

**Rev.F**

### Features

- Non-Isolated
- High Efficiency
- Fixed Frequency
- Wide Input
- Remote On/Off
- Class 1, Category 2, Non-Isolated DC/DC Converter (refer to IPC-9592)
- UL60950-1 Recognized (UL/cUL) (Pending)
- Input Under-Voltage Lockout
- OCP/SCP
- 2-Wire Remote sense
- 8 bit VID Digital Voltage Programming

### Applications

- Networking
- Computers and peripherals
- Telecommunications

### Description

The VRP4-CxE1A0 series are non-isolated step down dc/dc converters, and designed to be compatible with Intel VRM11.1 requirements. Standard features include current monitor, remote on/off, over current protection, remote sense, 8 bit VID digital voltage programming and a power good signal. This product also makes use of adaptive positioning to improve transient response performance. These products may be used almost anywhere low-voltage silicon is being employed and a nominal 12 Vdc source is available. Typical applications include file servers, work stations and other computing applications.

### Part Selection

Output Voltage	Input Voltage	Max. Output Current	Max. Output Power	Typical Efficiency	Model Number Active High
0.5 Vdc - 1.6 Vdc	6.0 Vdc - 13.2 Vdc	100 A	160 W	83%	VRP4-C0E1A0
0.5 Vdc - 1.6 Vdc	6.0 Vdc - 13.2 Vdc	110 A	176 W	81%	VRP4-C1E1A0
0.5 Vdc - 1.6 Vdc	6.0 Vdc - 13.2 Vdc	120 A	192 W	82%	VRP4-C2E1A0

**Notes:** Add "G" suffix at the end of the model number to indicate Tray Packaging.

### Part Number Explanation

V R P4 - Cx E 1A 0  
1 2 3 4 5 6 7

- 1---Vertical mount
- 2---RoHS 6, change "R" to "7" means RoHS 5
- 3---Series name, SIP
- 4---Series code
- 5--- Wide input range (6.0-13.2V)
- 6---Wide output range (0.5-1.6V)
- 7---Suffix, active high

## NON-ISOLATED DC/DC CONVERTERS

6.0 Vdc - 13.2 Vdc Input, 0.5 Vdc - 1.6 Vdc Output, VRM11.1 Compatible



Aug. 13, 2010

Bel Power Inc., a subsidiary of Bel Fuse Inc.

### Absolute Maximum Ratings

Parameter	Min	Typ	Max	Unit	Notes
Continuous non-operating Input Voltage	-0.3	-	15	V	
Remote On/Off	-0.3	-	5.3	V	
Ambient Temperature	0	-	70	°C	
Storage Temperature	-55	-	125	°C	

**Note:** Ratings used beyond the maximum ratings may cause a reliability degradation of the converter or may permanently damage the device.

### Input Specifications

Parameter	Min	Typ	Max	Unit	Notes
Operating Input Voltage	6.0	12	13.2	V	
Input Current (full load)	-	-	35	A	
Input Current (no load)	-	-	700	mA	
Input Current (no load, PSI# mode)	-	-	250	mA	
Remote Off Input Current	-	50	70	mA	
Input Reflected Ripple Current (rms)	-	50	100	mA	With simulated source impedance of 100nH, 5Hz to 20MHz. Use 2 * 470uF/16V Oscon capacitor.
Input Reflected Ripple Current (pk-pk)	-	150	200	mA	
I <sup>2</sup> t Inrush Current Transient	-	-	1	A <sup>2</sup> s	
Turn-on Voltage Threshold	5.8	6.5	7.5	V	
Turn-off Voltage Threshold	5.1	5.6	6.0	V	

**Note:** All specifications are typical at 25 °C unless otherwise stated.

### Output Specifications

Parameter	Min	Typ	Max	Unit	Notes
Output Voltage Set Point	1.07	1.085	1.1	V	VID=0x52
Adaptive Positioning	-	0.8	-	mOhm	Droop Impedance
Line Regulation	-	±5	±10	mV	
Regulation Over Temperature (0deg.C-70deg.C)	-	±5	±10	mV	
Ripple and Noise (pk-pk)	-	-	25	mV	20MHz BW
Ripple and Noise (rms)	-	-	10	mV	
Ripple and Noise (pk-pk) under worst case	-	-	30	mV	over all operating input voltage, load and temperature conditions.
Output Current Range VRP4-C0E1A0	0	-	70	A	Thermal Design Current
	-	-	100	A	Peak Current Rating
Output Current Range VRP4-C1E1A0	0	-	90	A	Thermal Design Current
	-	-	110	A	Peak Current Rating

# NON-ISOLATED DC/DC CONVERTERS

6.0 Vdc - 13.2 Vdc Input, 0.5 Vdc - 1.6 Vdc Output, VRM11.1 Compatible



Aug. 13, 2010

Bel Power Inc., a subsidiary of Bel Fuse Inc.

## Output Specifications (continued)

Parameter	Min	Typ	Max	Unit	Notes	
Output Current Range VRP4-C2E1A0	0	-	100	A	Thermal Design Current	
	-	-	120	A	Peak Current Rating	
Output DC Current Limit	105	-	125	A	VRP4-C0E1A0	
	115	-	135	A	VRP4-C1E1A0	
	125	-	155	A	VRP4-C2E1A0	
Short Circuit Surge Transient	-	-	5	A <sup>2</sup> s		
Turn on Time	-	2.5	5	mS		
Overshoot at Turn on	-	-	1	%		
Output Capacitance <sup>1</sup> (VRP4-C0E1A0)	-	4386	-	uF	Measured with 6*470uF/5mOhm ESR SP-CAP, and 37*22uF/0805 + 16*47uF/1206 ceramic capacitors on output.	
Output Capacitance <sup>1</sup> (VRP4-C2E1A0)	-	4148	-	uF	Measured with 6*470uF/5mOhm ESR SP-CAP, and 2*1uF/0402 + 2*10uF/0603 + 33*22uF/0805 + 5*22uF/1206 + 10*47uF/1206 ceramic capacitors on output.	
<b>Transient Response</b>						
ΔV50%~100% of Max Load	Overshoot	-	-	50	mV	di/dt=300A/us, Vin=12Vdc, Ta=25°C
	Settling Time	-	-	25	uS	
ΔV100%~50% of Max Load	Overshoot	-	-	50	mV	
	Settling Time	-	-	25	uS	

- Notes:** 1. Consult factory regarding external capacitance outside of this range.  
2. All specifications are typical at nominal input, full load at 25°C unless otherwise stated.

## General Specifications

Parameter	Min	Typ	Max	Unit	Notes
Efficiency	81	83	-	%	VID=0x52, Vin=12V, Iout=70A, PSI#=1
	79	81	-	%	VID=0x52, Vin=12V, Iout=100A, PSI#=1
	80	82	-	%	VID=0x52, Vin=12V, Iout=20A, PSI#=0
Switching Frequency	-	400	-	kHz	
Over Temperature Alert	100	-	110	°C	
Over Voltage Protection	-	V <sub>o,set</sub> + 0.175	-	V	Latch off
Weight	-	42	-	g	
FIT	500			-	Calculated Per Bell Core SR-332 (I <sub>o</sub> =80%load, T <sub>a</sub> = 25 °C, FIT=10 <sup>9</sup> /MTBF)
Dimensions	2.40 x 1.1 x 0.8 60.96 x 27.94 x 20.2			-	
	Inches (L x W x H)				
	Millimeters (L x W x H)				

**Note:** All specifications are typical at 25 °C unless otherwise stated.

# NON-ISOLATED DC/DC CONVERTERS

6.0 Vdc - 13.2 Vdc Input, 0.5 Vdc - 1.6 Vdc Output, VRM11.1 Compatible



Aug. 13, 2010

Bel Power Inc., a subsidiary of Bel Fuse Inc.

## Remote On/Off

Parameter	Min	Typ	Max	Unit	Notes
Signal Low (Unit Off)	-0.3	-	0.4	V	The remote on/off pin open, Unit off.
Signal High (Unit On)					
Current Sink	0	-	1	mA	

## Efficiency Data

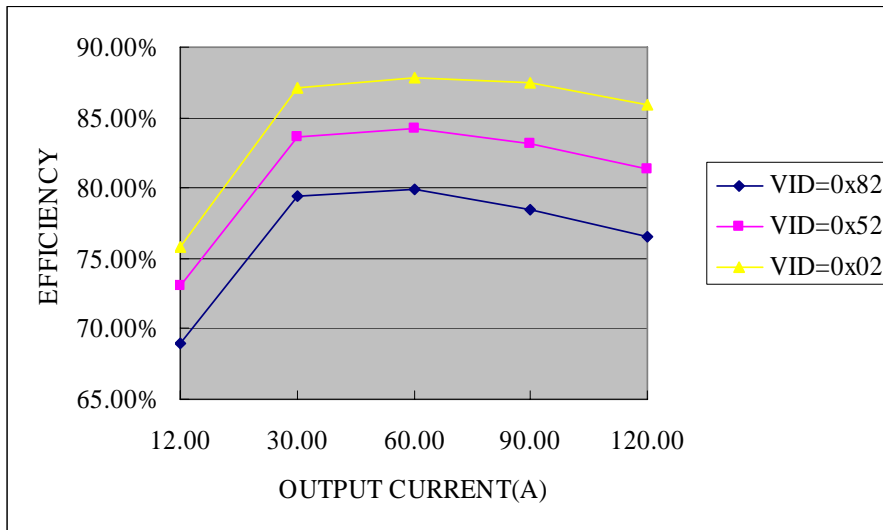

Efficiency of VRP4-C2E1A0, Vin=12V, PSI#=1

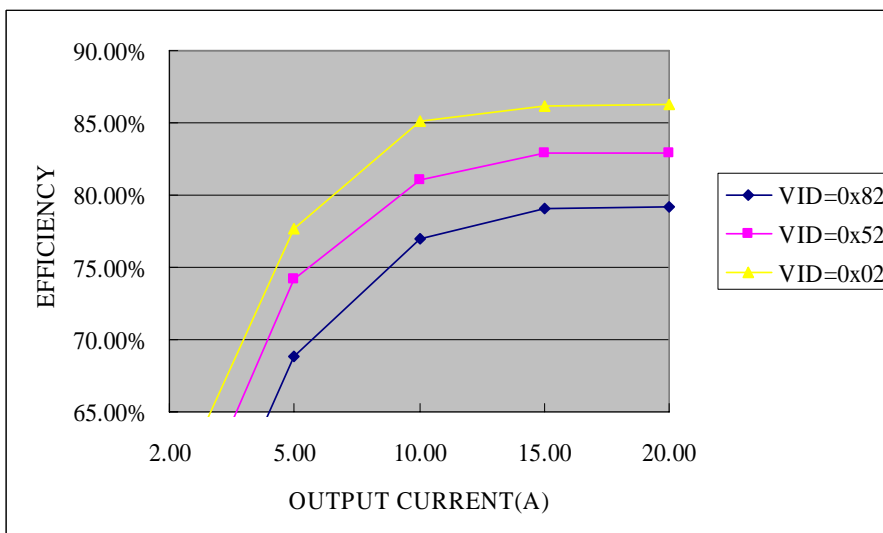

Efficiency of VRP4-C2E1A0, Vin=12V, PSI#=0

# NON-ISOLATED DC/DC CONVERTERS

6.0 Vdc - 13.2 Vdc Input, 0.5 Vdc - 1.6 Vdc Output, VRM11.1 Compatible



Aug. 13, 2010

Bel Power Inc., a subsidiary of Bel Fuse Inc.

## Thermal Derating Curves

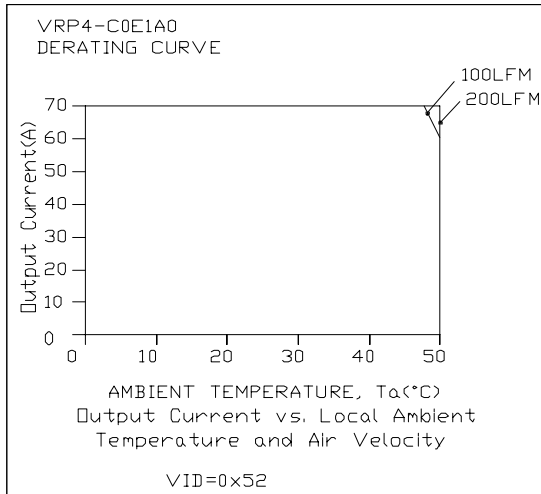
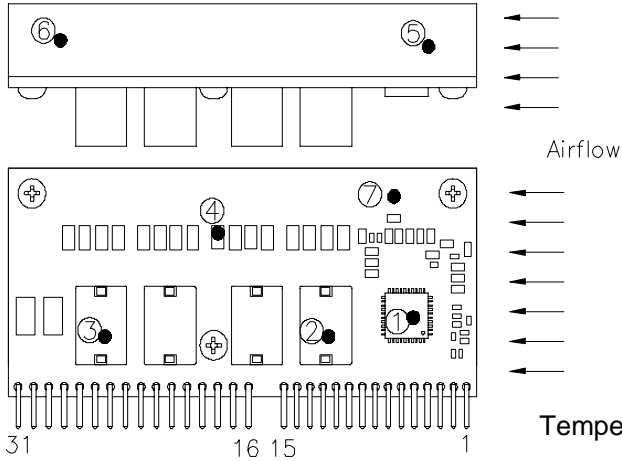

VRP4-C0E1A0 Vin=12V, VID=0x52

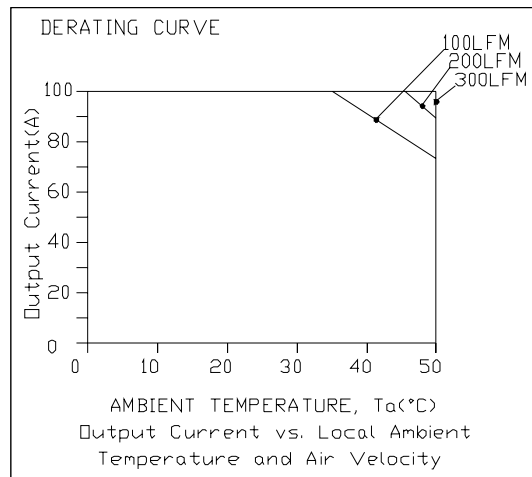

VRP4-C2E1A0 Vin=12V, VID=0x52

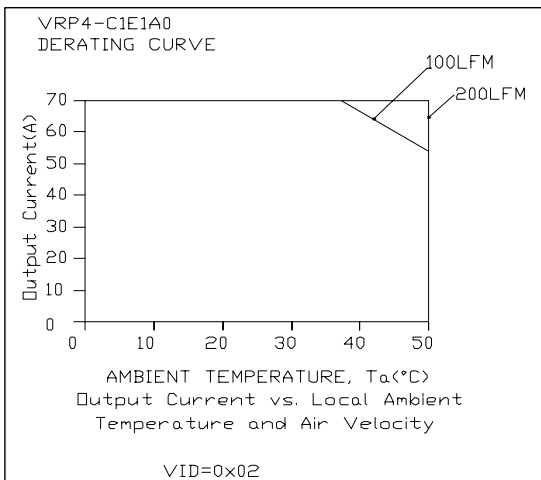

VRP4-C0E1A0 Vin=12V, VID=0x02

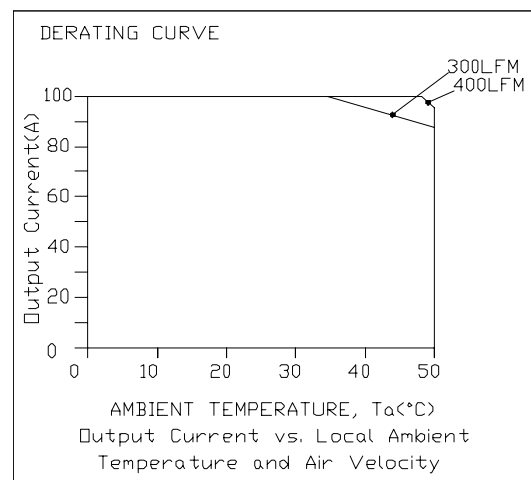

VRP4-C2E1A0 Vin=12V, VID=0x02

# NON-ISOLATED DC/DC CONVERTERS

6.0 Vdc - 13.2 Vdc Input, 0.5 Vdc - 1.6 Vdc Output, VRM11.1 Compatible



Aug. 13, 2010

Bel Power Inc., a subsidiary of Bel Fuse Inc.

## Ripple and Noise Waveforms

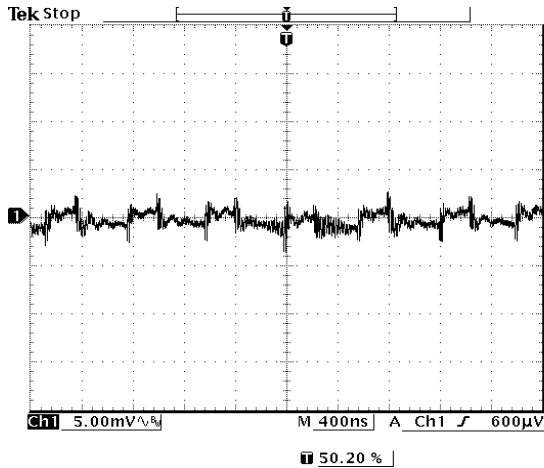

VRP4-C0E1A0  
12Vdc input, VID=0x52, Iout=70A, PSI#=1

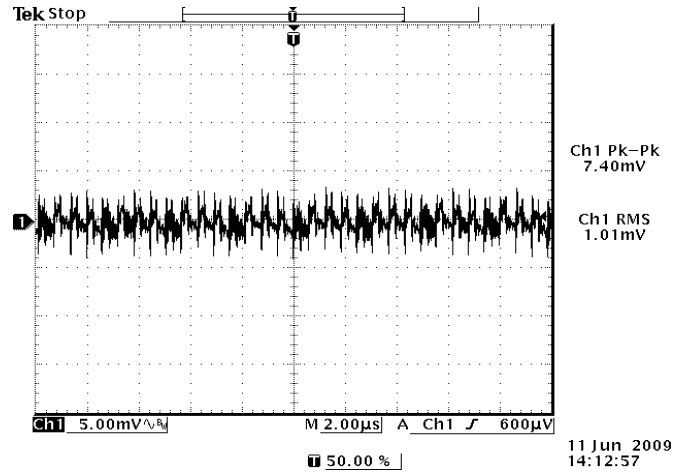

VRP4-C2E1A0  
12Vdc input, VID=0x52, Iout=100A, PSI#=1

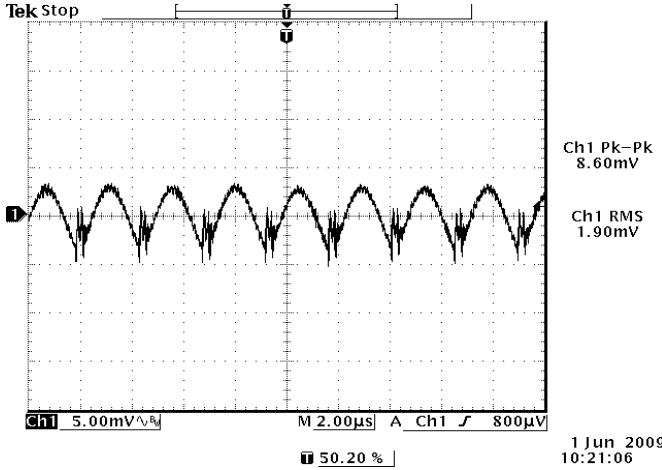

VRP4-C0E1A0  
12Vdc input, VID=0x52, Iout=20A, PSI#=0

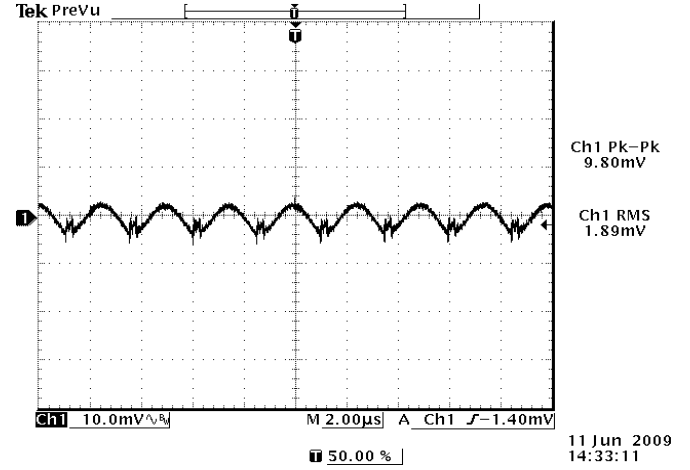

VRP4-C2E1A0  
12Vdc input, VID=0x52, Iout=20A, PSI#=0

# NON-ISOLATED DC/DC CONVERTERS

6.0 Vdc - 13.2 Vdc Input, 0.5 Vdc - 1.6 Vdc Output, VRM11.1 Compatible



Aug. 13, 2010

Bel Power Inc., a subsidiary of Bel Fuse Inc.

## Transient Response Waveforms

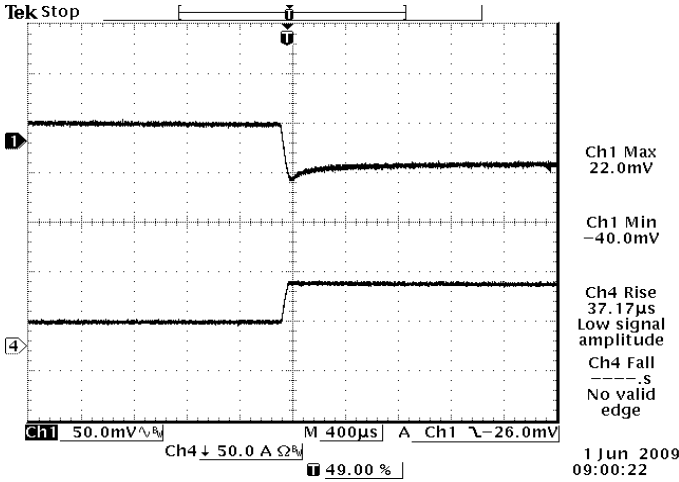

VRP4-C0E1A0

VID=0x52 25A-75A Load Transients at Vin=12V

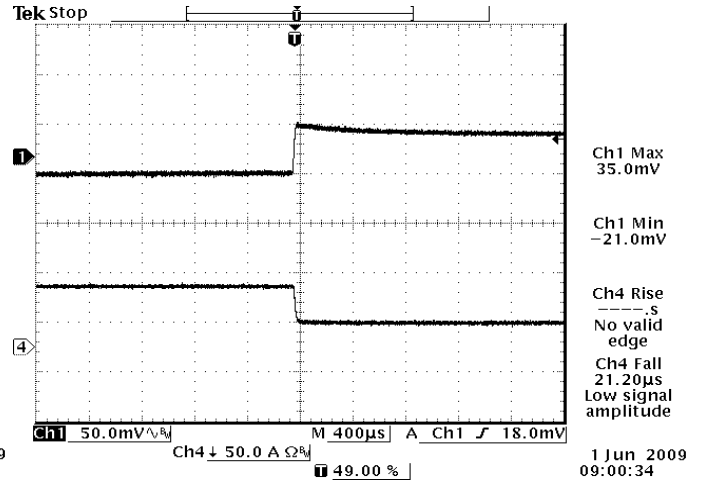

VRP4-C0E1A0

VID=0x52 75A-25A Load Transients at Vin=12V

## Startup & Shutdown

### Rise time

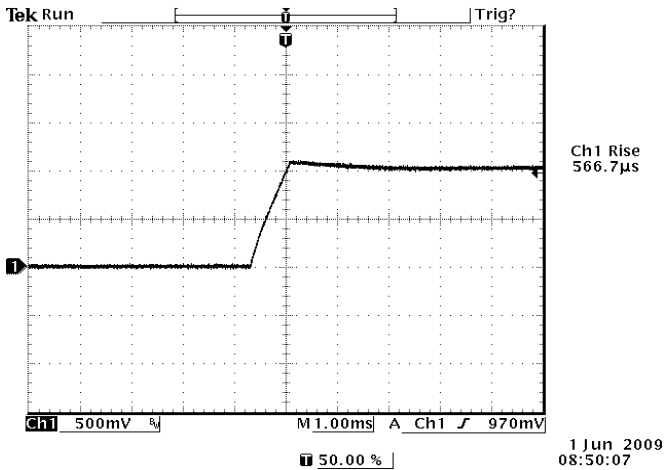

VID=0x52, Vin=12V, Iout=70A

### Startup time

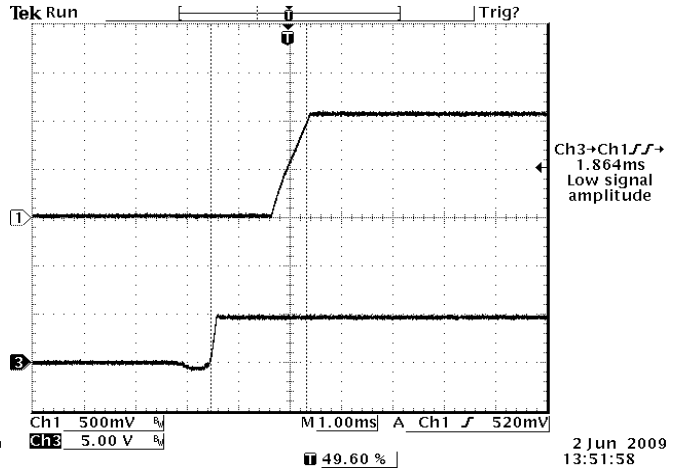

VID=0x52, Vin=12V, Iout=0A

CH 1: Vout

CH 3: IOUTEN

## NON-ISOLATED DC/DC CONVERTERS

6.0 Vdc - 13.2 Vdc Input, 0.5 Vdc - 1.6 Vdc Output, VRM11.1 Compatible



Aug. 13, 2010

*Bel Power Inc., a subsidiary of Bel Fuse Inc.*

### Remote Sense

This module has remote sense compensation feature. It can minimize the effects of resistance between module's output and load in system layout and facilitates accurate voltage regulation at load terminals or other selected point.

1. The remote sense lines carries very little current and hence do not require a large cross-sectional area.
2. This module compensates for a maximum drop of 10% of the nominal output voltage.
3. When using remote sense compensation, all the resistance, parasitic inductance and capacitance of the system are incorporated within the feedback loop of this module. It can make an effect on the module's compensation, affecting the stability and dynamic response. A 0.1 $\mu$ F ceramic capacitor can be connected at the point of load to de-couple noise on the sense wires.
4. Recommend the connection of remote sense compensation as below figure. There are a resistor RS+ (5.11 Kohm) from Vo+ to Sense+ and a resistor RS- (5.11 Kohm) from Vo- to Sense- inside of this module.

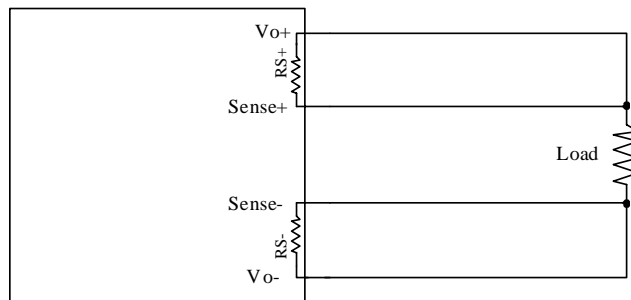

5. If not using remote sense compensation, please connect sense directly to output at module's pin, that is, connect sense+ to Vo+ and sense- to Vo- at module's pin, the shorter the better. See below figure.

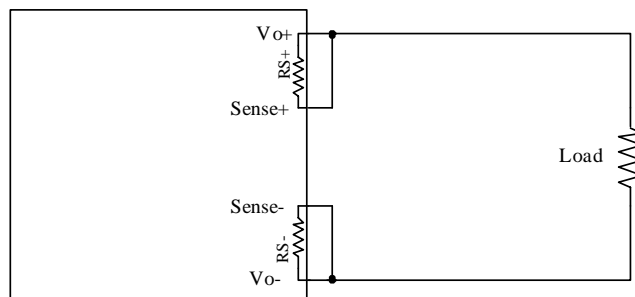



## NON-ISOLATED DC/DC CONVERTERS

6.0 Vdc - 13.2 Vdc Input, 0.5 Vdc - 1.6 Vdc Output, VRM11.1 Compatible



Aug. 13, 2010

*Bel Power Inc., a subsidiary of Bel Fuse Inc.*

### Over Current Protection

To provide protection in a fault output overload condition, the module is equipped with internal current-limiting circuitry and can endure current limiting for a few milli-seconds. If the over current condition persists beyond a few milliseconds, the module will shut down into hiccup mode. The module operates normally when the output current goes into specified range.

### Over Voltage Protection

The output over-voltage protection consists of circuitry that monitors the voltage on the output terminals. If the voltage on the output terminals exceeds the over voltage protection threshold the module will shutdown into latch off mode. The over-voltage latch can be reset by either cycling the input power or toggling the on/off signal for one second at least.

### Input Under-voltage Lockout

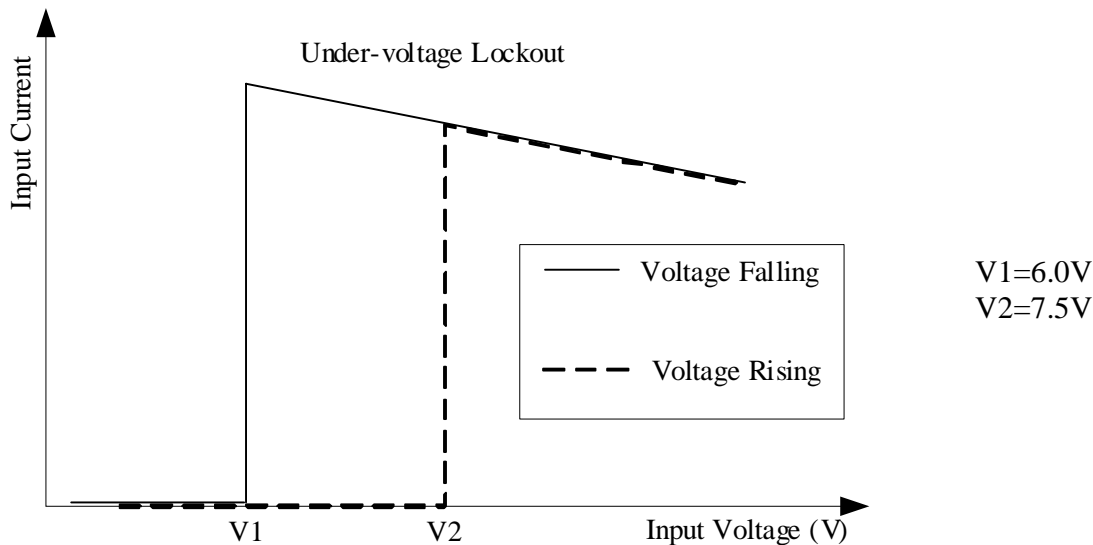

# NON-ISOLATED DC/DC CONVERTERS

6.0 Vdc - 13.2 Vdc Input, 0.5 Vdc - 1.6 Vdc Output, VRM11.1 Compatible



Aug. 13, 2010

Bel Power Inc., a subsidiary of Bel Fuse Inc.

## Power Good

1. This module has a power good indicator output. Power good pin used positive logic and is open collector.
2. Power good pin can sink 10mA.
3. The maximum voltage pulled up externally on Power Good pin should not exceed 5V.
4. When the output reaches the VID setting, the power good pin will be pulled high with the fixed delay of 85us.

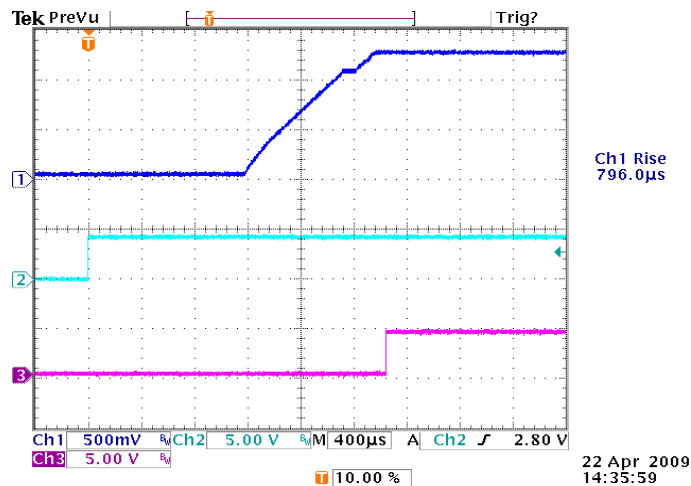

Typical Start-up Using Remote ON/OFF (Vin=12.0V, VID=0x32, Io=0A)

Ch1: Vout  
Ch2: OUTEN  
Ch3: VR\_READY

## IMON Diagram

IMON is the output pin of sensed, thermally compensated, average current. The voltage at IMON pin is proportional to the load current and the resistor value (R<sub>IMON</sub>), and internally clamped to 1.11 Vdc plus the remote ground potential difference. If the clamped voltage (1.11 Vdc) is triggered, it will initiate the over-current shutdown. During the dynamic VID, the OCP function of this pin is disabling to avoid falsely triggering.

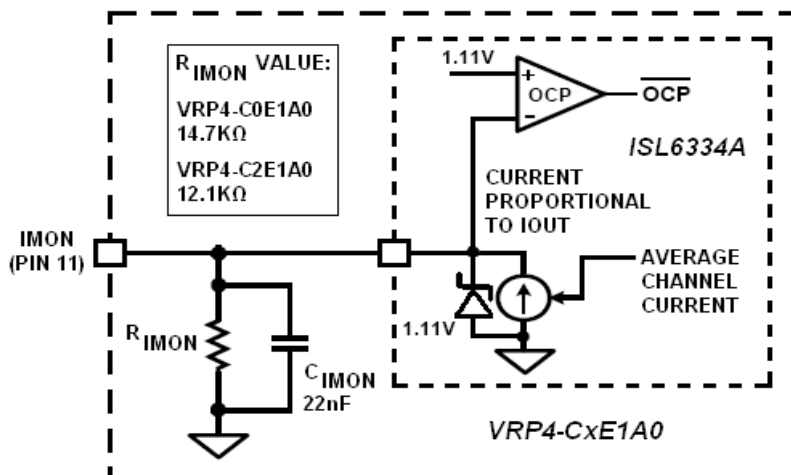

# NON-ISOLATED DC/DC CONVERTERS

6.0 Vdc - 13.2 Vdc Input, 0.5 Vdc - 1.6 Vdc Output, VRM11.1 Compatible



Aug. 13, 2010

Bel Power Inc., a subsidiary of Bel Fuse Inc.

## Mechanical Outline

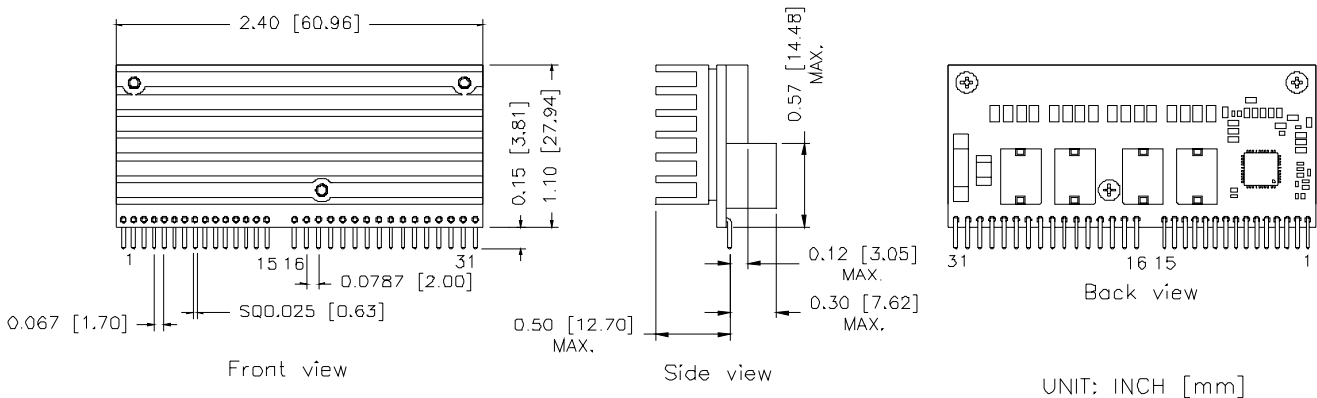

### RECOMMENDED PAD LAYOUT

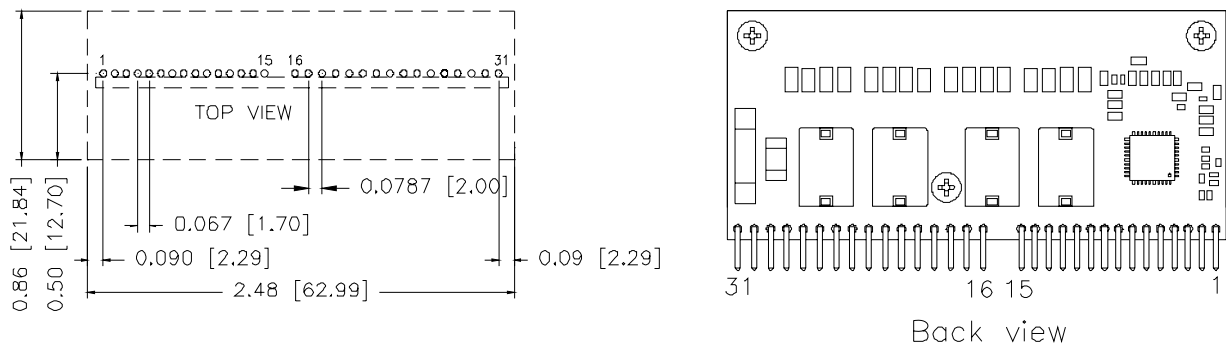

Pin	Function	Pin	Function	Pin	Function	Pin	Function
1	VID0	9	Vsense+	17	Vout	25	GND
2	VID1	10	Vesense-	18	Vout	26	Vout
3	VID2	11	IMON	19	GND	27	Vout
4	VID3	12	PSI#	20	GND	28	GND
5	VID4	13	OUTEN	21	Vout	29	GND
6	VID5	14	VR_READY	22	Vout	30	Vin
7	VID6	15	VR_HOT	23	Vout	31	Vin
8	VID7	16	GND	24	GND		

**Note:** This module is recommended and compatible with Pb-Free Wave Soldering and must be soldered using a peak solder temperature of no more than 260 °C for less than 5 seconds.

### Note:

- 1) All Pins: Material - Copper Alloy;  
Finish – 3 inches minimum Gold over 50 micro inches minimum Nickel plate.
- 2) Undimensioned components are shown for visual reference only.
- 3) All dimensions in inches (mm); Tolerances: x.xx +/-0.02 in. (x.x +/-0.5mm) x.xxx +/-0.010 in. (x.xx +/-0.25mm).

## NON-ISOLATED DC/DC CONVERTERS

6.0 Vdc - 13.2 Vdc Input, 0.5 Vdc - 1.6 Vdc Output, VRM11.1 Compatible



Aug. 13, 2010

*Bel Power Inc., a subsidiary of Bel Fuse Inc.*

### Signal Definitions

VID0, VID1, VID2, VID3, VID4, VID5, VID6, VID7	Logic level inputs used to set the output voltage refer to VID table. Connect VID0 thru VID7 pins to open-drain outputs with external pull-up resistors or to active-pull-up outputs. Valid logic low is -0.3V to 0.4V, valid logic high level is 0.8V to 5.3V.
Vsense+, Vsense-	Remote voltage sense lines. Connect these at the point of load, to VOUT and GND respectively.
IMON	The output pin of sensed, thermally compensated average current. The voltage at IMON pin is proportional to the load current, and internally clamped to 1.11V plus the remote ground potential difference. If the clamped voltage (1.11V) is triggered, it will initiate the overcurrent shutdown. During the dynamic VID, the OCP function of this pin is disable to avoid falsely triggering.
PSI#	A low input signal indicates the low power mode operation of the processor. The controller drops the number of active phases to single phase operation. A high input signal pulls the controller back to normal operation.
OUTEN	Logic level input used to enable the converter when high. Valid logic low is -0.3V to 0.4V, valid logic high level is 0.9V to 5.3V.
VR_READY	VR_READY indicates that soft-start has completed and the output voltage is within the regulated range around VID setting. It is an open-drain logic output. When OCP or OVP occurs, VR_READY will be pulled to low. It will also be pulled low if the output voltage is below the undervoltage threshold.
VR_HOT	VR_HOT is used as an indication of high VR temperature. It will be pulled high if the measured VR temperature is less than a certain level, and pulled low when the measured VR temperature reaches a certain level.
Vout	Output voltage available to the load.
GND	Common return for both input and output
Vin	Input power to the converter

# NON-ISOLATED DC/DC CONVERTERS

6.0 Vdc - 13.2 Vdc Input, 0.5 Vdc - 1.6 Vdc Output, VRM11.1 Compatible



Aug. 13, 2010

*Bel Power Inc., a subsidiary of Bel Fuse Inc.*

## VID CODES

### VRM11.1 VID CODES

HEX (VID7 - VID0)	Vout (VDC)
0 0	OFF
0 1	OFF
0 2	1.60000
0 3	1.59375
0 4	1.58750
0 5	1.58125
0 6	1.57500
0 7	1.56875
0 8	1.56250
0 9	1.55625
0 A	1.55000
0 B	1.54375
0 C	1.53750
0 D	1.53125
0 E	1.52500
0 F	1.51875
1 0	1.51250
1 1	1.50625
1 2	1.50000
1 3	1.49375
1 4	1.48750
1 5	1.48125
1 6	1.47500
1 7	1.46875
1 8	1.46250
1 9	1.45625
1 A	1.45000
1 B	1.44375
1 C	1.43750
1 D	1.43125
1 E	1.42500
1 F	1.41875
2 0	1.41250
2 1	1.40625
2 2	1.40000
2 3	1.39375
2 4	1.38750
2 5	1.38125
2 6	1.37500
2 7	1.36875
2 8	1.36250
2 9	1.35625
2 A	1.35000
2 B	1.34375
2 C	1.33750
2 D	1.33125
2 E	1.32500
2 F	1.31875

HEX (VID7 - VID0)	Vout (VDC)
3 0	1.31250
3 1	1.30625
3 2	1.30000
3 3	1.29375
3 4	1.28750
3 5	1.28125
3 6	1.27500
3 7	1.26875
3 8	1.26250
3 9	1.25625
3 A	1.25000
3 B	1.24375
3 C	1.23750
3 D	1.23125
3 E	1.22500
3 F	1.21875
4 0	1.21250
4 1	1.20625
4 2	1.20000
4 3	1.19375
4 4	1.18750
4 5	1.18125
4 6	1.17500
4 7	1.16875
4 8	1.16250
4 9	1.15625
4 A	1.15000
4 B	1.14375
4 C	1.13750
4 D	1.13125
4 E	1.12500
4 F	1.11875
5 0	1.11250
5 1	1.10625
5 2	1.10000
5 3	1.09375
5 4	1.08750
5 5	1.08125
5 6	1.07500
5 7	1.06875
5 8	1.06250
5 9	1.05625
5 A	1.05000
5 B	1.04375
5 C	1.03750
5 D	1.03125
5 E	1.02500
5 F	1.01875

HEX (VID7 - VID0)	Vout (VDC)
6 0	1.01250
6 1	1.00625
6 2	1.00000
6 3	0.99375
6 4	0.98750
6 5	0.98125
6 6	0.97500
6 7	0.96875
6 8	0.96250
6 9	0.95625
6 A	0.95000
6 B	0.94375
6 C	0.93750
6 D	0.93125
6 E	0.92500
6 F	0.91875
7 0	0.91250
7 1	0.90625
7 2	0.90000
7 3	0.89375
7 4	0.88750
7 5	0.88125
7 6	0.87500
7 7	0.86875
7 8	0.86250
7 9	0.85625
7 A	0.85000
7 B	0.84375
7 C	0.83750
7 D	0.83125
7 E	0.82500
7 F	0.81875
8 0	0.81250
8 1	0.80625
8 2	0.80000
8 3	0.79375
8 4	0.78750
8 5	0.78125
8 6	0.77500
8 7	0.76875
8 8	0.76250
8 9	0.75625
8 A	0.75000
8 B	0.74375
8 C	0.73750
8 D	0.73125
8 E	0.72500
8 F	0.71875

HEX (VID7 - VID0)	Vout (VDC)
9 0	0.71250
9 1	0.70625
9 2	0.70000
9 3	0.69375
9 4	0.68750
9 5	0.68125
9 6	0.67500
9 7	0.66875
9 8	0.66250
9 9	0.65625
9 A	0.65000
9 B	0.64375
9 C	0.63750
9 D	0.63125
9 E	0.62500
9 F	0.61875
A 0	0.61250
A 1	0.60625
A 2	0.60000
A 3	0.59375
A 4	0.58750
A 5	0.58125
A 6	0.57500
A 7	0.56875
A 8	0.56250
A 9	0.55625
A A	0.55000
A B	0.54375
A C	0.53750
A D	0.53125
A E	0.52500
A F	0.51875
B 0	0.51250
B 1	0.50625
B 2	0.50000
F E	OFF
F F	OFF

**NON-ISOLATED DC/DC CONVERTERS**  
 6.0 Vdc - 13.2 Vdc Input, 0.5 Vdc - 1.6 Vdc Output, VRM11.1 Compatible



Aug. 13, 2010

*Bel Power Inc., a subsidiary of Bel Fuse Inc.*

**Revision History**

Date	Revision	Changes Detail	Approval
2009-04-09	A	First release	HL Lu
2009-04-22	B	1. Update mechanical drawing; 2. Correct error in part number explanation; 3. Add ripple and start up time waveforms; 4. Remove some "TBD" information.	HL Lu
2009-05-05	C	1. Add efficiency curve; 2. Update NR curves; 3. Add Signal Definitions and VID CODES	HL Lu
2010-03-22	D	1. Adjust input range; 2. Input Specification: 1) add no load input current at PSI# mode, 2) amend the value of full load/no load input current, 3) reflected ripple current, 4) turn on/off threshold voltage; 3. Output Specification: 1) current limit of VRP4-C2E1A0; 2) adjust output capacitance ; 4. General Specification: 1) update efficiency data, 2) add FIT data 5. update efficiency curves, add thermal derating curves, update NR and TR curves, update start up time curve and add rise time curve, add curve for power good; 6. Update mechanical drawing (bottom view and pin spacing).	Jack Fan
2010-04-30	E	1. Update TD of VRP4-C0E1A0; 2. Update the RS+ and RS- value in Remote sense section.	Jack Fan
2010-08-13	F	Add the diagram of IMON	JZ Wang

**RoHS Compliance**

Complies with the European Directive 2002/95/EC, calling for the elimination of lead and other hazardous substances from electronic products.



©2010 Bel Fuse Inc. Specifications subject to change without notice. 081310

**CORPORATE**

**Bel Fuse Inc.**  
 206 Van Vorst Street  
 Jersey City, NJ 07302  
 Tel 201-432-0463  
 Fax 201-432-9542  
[www.belfuse.com](http://www.belfuse.com)

**FAR EAST**

**Bel Fuse Ltd.**  
 8F/ 8 Luk Hop Street  
 San Po Kong  
 Kowloon, Hong Kong  
 Tel 852-2328-5515  
 Fax 852-2352-3706  
[www.belfuse.com](http://www.belfuse.com)

**EUROPE**

**Bel Fuse Europe Ltd.**  
 Preston Technology Management Centre  
 Marsh Lane, Suite G7, Preston  
 Lancashire, PR1 8UD, U.K.  
 Tel 44-1772-556601  
 Fax 44-1772-888366  
[www.belfuse.com](http://www.belfuse.com)