

SCR / SCR and SCR / DIODE
MAGN-A-pak™ Power Modules

Features

- High voltage
- Electrically isolated base plate
- 3000 V_{RMS} isolating voltage
- Industrial standard package
- Simplified mechanical designs, rapid assembly
- High surge capability
- Large creepage distances
- UL E78996 approved 

170A
230A
250A

Description

This new IRK serie of MAGN-A-paks modules uses high voltage power thyristor/thyristor and thyristor/diode in seven basic configurations. The semiconductors are electrically isolated from the metal base, allowing common heatsinks and compact assemblies to be built. They can be interconnected to form single phase or three phase bridges or as AC-switches when modules are connected in anti-parallel mode.

These modules are intended for general purpose applications such as battery chargers, welders and plating equipment and where high voltage and high current are required (motor drives, U.P.S., etc.).

Major Ratings and Characteristics

Parameters	IRK.170..	IRK.230..	IRK.250..	Units	
$I_{T(AV)}$ @ 85°C	170	230	250	A	
$I_{T(RMS)}$	377	510	555	A	
I_{TSM}	@ 50Hz	5100	7500	8500	A
	@ 60Hz	5350	7850	8900	A
I^2t	@ 50Hz	131	280	361	KA ² s
	@ 60Hz	119	256	330	KA ² s
$I^2\sqrt{t}$	1310	2800	3610	KA ² /s	
V_{DRM} / V_{RRM}	Up to 1600	Up to 2000	Up to 1600	V	
T_J range	-40 to 130			°C	

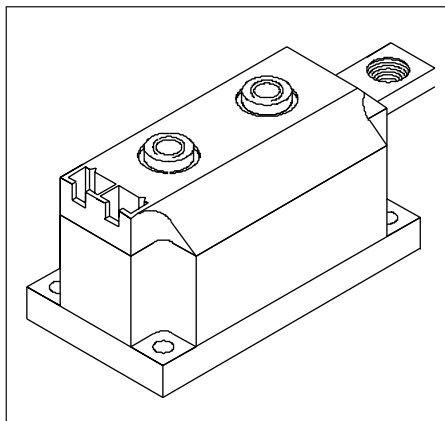

IRK.170, .230, .250 Series

Bulletin I27102 rev. A 10/97

International
IR Rectifier

ELECTRICAL SPECIFICATIONS

Voltage Ratings

Type number	Voltage Code	V_{RRM}, V_{DRM} , maximum repetitive peak reverse and off-state blocking voltage V	V_{RSM} , maximum non-repetitive peak reverse voltage V	I_{RRM}, I_{DRM} max @ 130°C mA
IRK.170- IRK.250-	04	400	500	50
	08	800	900	
	12	1200	1300	
	14	1400	1500	
	16	1600	1700	
IRK.230-	08	800	900	50
	12	1200	1300	
	16	1600	1700	
	18	1800	1900	
	20	2000	2100	

On-state Conduction

Parameters	IRK.170	IRK.230	IRK.250	Units	Conditions		
$I_{T(AV)}$ Maximum average on-state current @ Case temperature	170	230	250	A	180° conduction, half sine wave		
	85	85	85	°C			
$I_{T(RMS)}$ Maximum RMS on -state current	377	510	555	A	as AC switch		
I_{TSM} Maximum peak, one-cycle on-state, non-repetitive surge current	5100	7500	8500	A	t = 10ms	No voltage	Sinusoidal half wave, initial $T_J = T_J$ max
	5350	7850	8900		t = 8.3ms	reapplied	
	4300	6300	7150		t = 10ms	100% V_{RRM}	
	4500	6600	7500		t = 8.3ms	reapplied	
I^2t Maximum I^2t for fusing	131	280	361	KA ² s	t = 10ms	No voltage	
	119	256	330		t = 8.3ms	reapplied	
	92.5	198	255		t = 10ms	100% V_{RRM}	
	84.4	181	233		t = 8.3ms	reapplied	
$I^2\sqrt{t}$ Maximum $I^2\sqrt{t}$ for fusing	1310	2800	3610	KA ² √s	t = 0.1 to 10ms, no voltage reapplied		
$V_{T(TO)1}$ Low level value of threshold voltage	0.89	1.03	0.97	V	$(16.7\% \times \pi \times I_{T(AV)} < I < \pi \times I_{T(AV)})$, $T_J = T_J$ max.		
$V_{T(TO)2}$ High level value of threshold voltage	1.12	1.07	1.00	V	$(I > \pi \times I_{T(AV)})$, $T_J = T_J$ max.		
r_{t1} Low level on-state slope resistance	1.34	0.77	0.60	mΩ	$(16.7\% \times \pi \times I_{T(AV)} < I < \pi \times I_{T(AV)})$, $T_J = T_J$ max.		
r_{t2} High level on-state slope resistance	0.96	0.73	0.57	mΩ	$(I > \pi \times I_{T(AV)})$, $T_J = T_J$ max.		
V_{TM} Maximum on-state voltage drop	1.60	1.59	1.44	V	$I_{TM} = \pi \times I_{T(AV)}$, $T_J = T_J$ max., 180° conduction Av. power = $V_{T(TO)} \times I_{T(AV)} + r_t \times (I_{T(RMS)})^2$		
I_H Maximum holding current	500	500	500	mA	Anode supply=12V, initial $I_T=30A$, $T_J=25^\circ C$		
I_L Maximum latching current	1000	1000	1000	mA	Anode supply=12V, resistive load=1Ω gate pulse: 10V, 100μs, $T_J = 25^\circ C$		

Switching

Parameters	IRK.170	IRK.230	IRK.250	Units	Conditions
t_d Typical delay time		1.0		μs	$T_J = 25^\circ C$, Gate Current=1A $dI_{g/dt}=1A/\mu s$ $V_d = 0.67\% V_{DRM}$
t_r Typical rise time		2.0			
t_q Typical turn-off time		50 - 150		μs	$I_{TM} = 300 A$; $-dI/dt=15 A/\mu s$; $T_J = T_J$ max ; $V_r = 50 V$; $dV/dt = 20 V/\mu s$; Gate 0 V, 100 ohm

Blocking

Parameters	IRK.170	IRK.230	IRK.250	Units	Conditions
I_{RRM} I_{DRM} Max. peak reverse and off-state leakage current	50			mA	$T_J = T_J \text{ max.}$
V_{INS} RMS isolation voltage	3500			V	50Hz, circuit to base, all termin. shorted, 25°C, 1s
dv/dt Critical rate of rise of off-state voltage	1000			V/ μ s	$T_J = T_J \text{ max.}$, exponential to 67% rated V_{DRM}

Triggering

Parameters	IRK.170	IRK.230	IRK.250	Units	Conditions
P_{GM} Maximum peak gate power	10.0			W	$tp \leq 5\text{ms}$, $T_J = T_J \text{ max.}$
$P_{G(AV)}$ Maximum average gate power	2.0			W	$f = 50\text{Hz}$, $T_J = T_J \text{ max.}$
$+I_{GM}$ Maximum peak gate current	3.0			A	$tp \leq 5\text{ms}$, $T_J = T_J \text{ max.}$
$-V_{GT}$ Max. peak negative gate voltage	5.0			V	$tp \leq 5\text{ms}$, $T_J = T_J \text{ max.}$
V_{GT} Maximum required DC gate voltage to trigger	4.0			V	$T_J = -40^\circ\text{C}$ Anode supply = 12V, resistive load ; $R_a = 1\ \Omega$ $T_J = 25^\circ\text{C}$ $T_J = T_J \text{ max.}$
	3.0			V	
	2.0			V	
I_{GT} Maximum required DC gate current to trigger	350			mA	$T_J = -40^\circ\text{C}$ Anode supply = 12V, resistive load ; $R_a = 1\ \Omega$ $T_J = 25^\circ\text{C}$ $T_J = T_J \text{ max.}$
	200			mA	
	100			mA	
V_{GD} Maximum gate voltage that will not trigger	0.25			V	@ $T_J = T_J \text{ max.}$, rated V_{DRM} applied
I_{GD} Maximum gate current that will not trigger	10.0			mA	@ $T_J = T_J \text{ max.}$, rated V_{DRM} applied
di/dt Max rate of rise of turned-on current	500			A/ μ s	@ $T_J = T_J \text{ max.}$, $I_{TM} = 400\ \text{A}$ rated V_{DRM} applied

Thermal and Mechanical Specifications

Parameters	IRK.170	IRK.230	IRK.250	Units	Conditions	
T_J Junction operating temperature	-40 to 130			$^\circ\text{C}$		
T_{stg} Storage temperature range	-40 to 150			$^\circ\text{C}$		
R_{thJC} Maximum thermal resistance junction to case	0.17	0.125	0.125	K/W	Per junction, DC operation	
R_{thCS} Thermal resistance, case to heatsink	0.02	0.02	0.02	K/W	Mounting surface flat, smooth and greased (per module)	
T Mounting torque $\pm 10\%$					A mounting compound is recommended and the torque should be rechecked after a period of about 3 hours to allow for the spread of the compound	
				MAP to heatsink		4 to 6
				Busbar to MAP	4 to 6	Nm
wt Approximate weight	500			g		
	17.8			oz		
Case style	MAGN-A-pak					

IRK.170, .230, .250 Series

Bulletin I27102 rev. A 10/97

International
IR Rectifier

ΔR Conduction (per Junction)

(The following table shows the increment of thermal resistance R_{thJC} when devices operate at different conduction angles than DC)

Devices	Sinusoidal conduction @ T_J max.					Rectangular conduction @ T_J max.					Units
	180°	120°	90°	60°	30°	180°	120°	90°	60°	30°	
IRK.170-	0.009	0.010	0.010	0.020	0.032	0.007	0.011	0.015	0.020	0.033	K/W
IRK.230-	0.009	0.010	0.010	0.020	0.032	0.007	0.011	0.015	0.020	0.033	
IRK.250-	0.009	0.010	0.014	0.020	0.032	0.007	0.011	0.015	0.020	0.033	

MAGN-A-paks Suitable for Current Source Inverters

Thyristor		Diode	$I_{T(AV)} / I_{F(AV)} @ T_C$		
V_{DRM}	V_{RSM}	V_{RRM}	170A @ 85°C	230A @ 85°C	250A @ 85°C
1400	1500	2000	IRKH170-14D20	IRKH230-14D20	IRKH250-14D20
1400	1500	2000	IRKL170-14D20	IRKL230-14D20	IRKL250-14D20
1600	1700	2500	IRKH170-16D25	IRKH230-16D25	IRKH250-16D25
1600	1700	2500	IRKL170-16D25	IRKL230-16D25	IRKL250-16D25
1800	1900	2800	Not Available	IRKH230-18D28	Not Available
1800	1900	2800	Not Available	IRKL230-18D28	Not Available
2000	2100	3200	Not Available	IRKH230-20D32	Not Available
2000	2100	3200	Not Available	IRKL230-20D32	Not Available

For all other parameters and characteristics refer to standard IRKH... and IRKL... modules.

Application Notes

Current Source Inverter using 9 MAGN-A-paks

Current Source Inverters

Current-Source Inverters (also known as Sequentially Commutated Inverters) use Phase Control (as opposed to Fast) Thyristors and Diodes.

The advantages of Current Source Inverters lie in their ease control, absence of large commutation inductances and limited fault currents. Their simple construction, illustrated by the circuit on the left, is further enhanced by the use of MAGN-A-paks which allow the power circuit of an Inverter to be realised with 6 capacitors and 9 MAGN-A-paks all mounted on just one heatsink.

The optimal design of Current Source Inverters requires the use of Diodes with blocking voltages greater than those of the thyristors. This departure from conventional half-bridge modules is catered for by MAGN-A-pak range with Thyristors up to 2000V and Diodes up to 3200V.

Ordering Information Table

Device Code						
IRK	T	250	-	14	D20	N
①	②	③		④	⑤	⑥

<p>1 - Module type</p> <p>2 - Circuit configuration (See Outline Table)</p> <p>3 - Current rating</p> <p>4 - Voltage code: Code x 100 = V_{RRM} (See Voltage Ratings Table)</p> <p>5 - Current Source Inverters Types</p> <p>6 - None = Standard devices</p> <p style="margin-left: 20px;">N = aluminum nitride substrate</p>
--

Outline Table

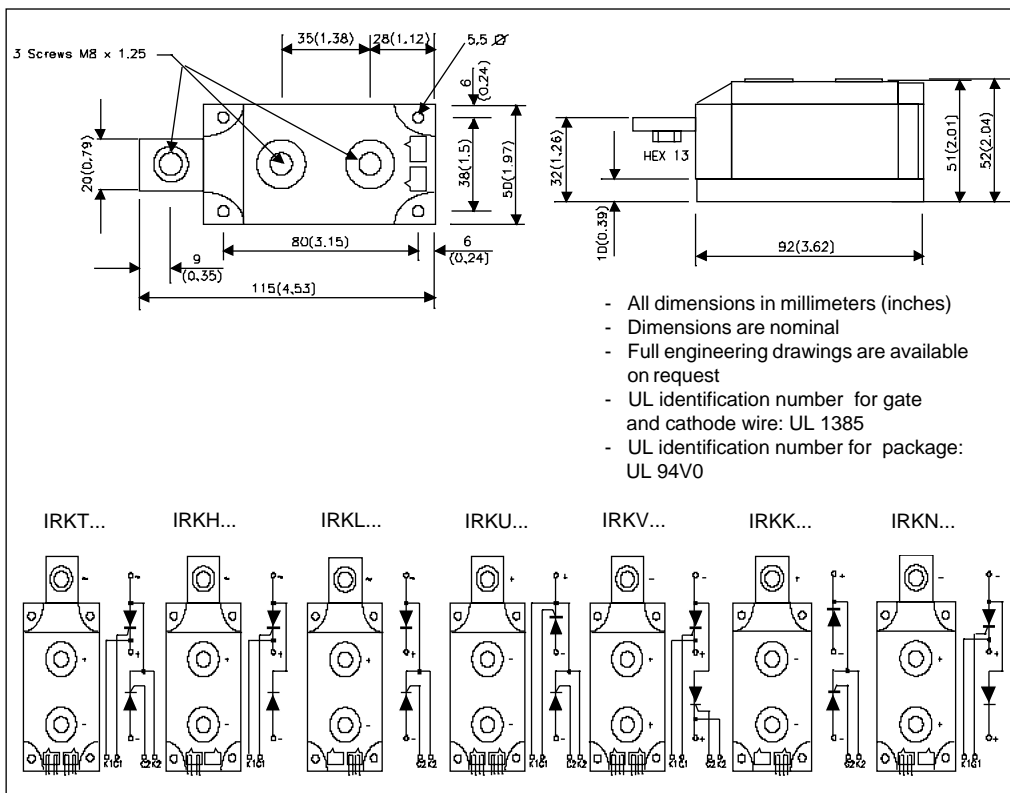

NOTE: To order the Optional Hardware see Bulletin I27900

IRK.170, .230, .250 Series

Bulletin I27102 rev. A 10/97

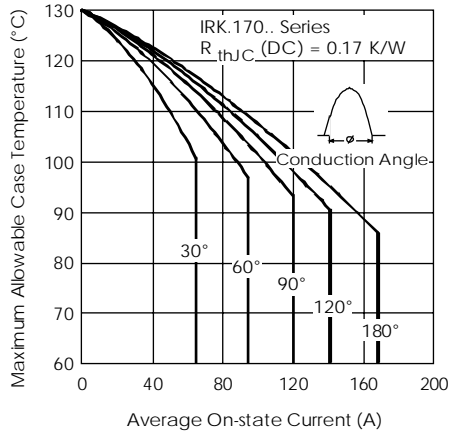

Fig. 1 - Current Ratings Characteristics

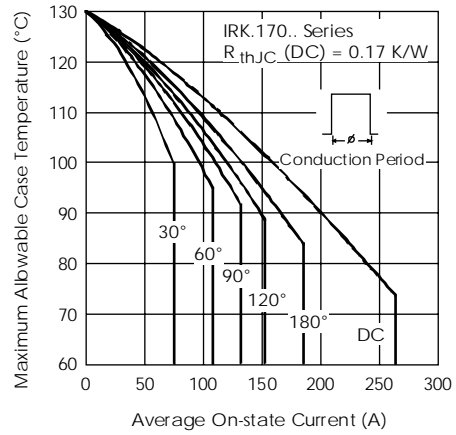

Fig. 2 - Current Ratings Characteristics

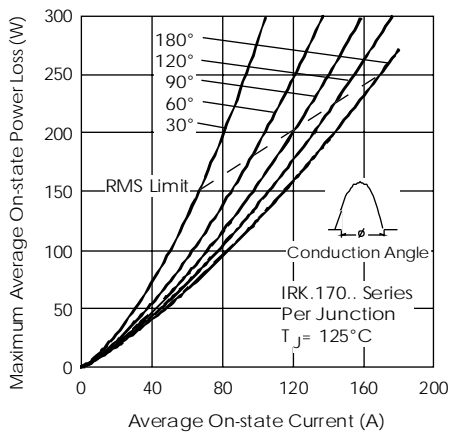

Fig. 3 - On-state Power Loss Characteristics

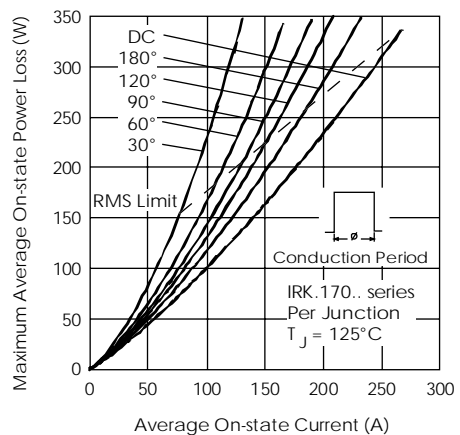

Fig. 4 - On-state Power Loss Characteristics

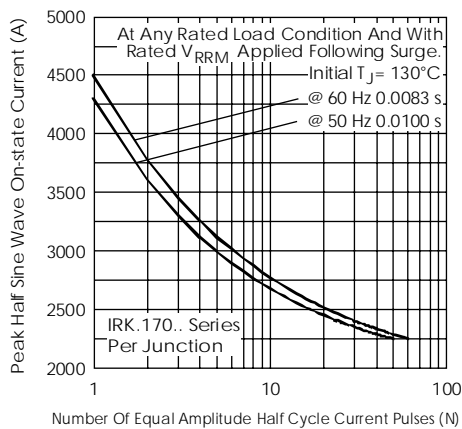

Fig. 5 - Maximum Non-Repetitive Surge Current

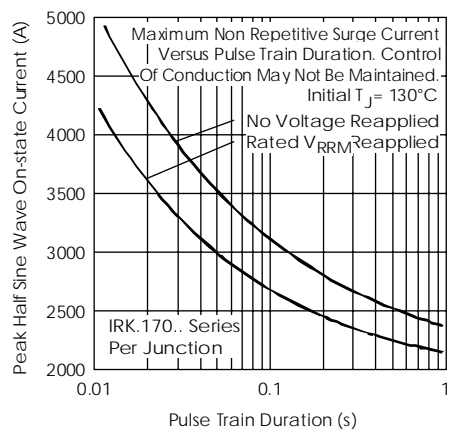

Fig. 6 - Maximum Non-Repetitive Surge Current

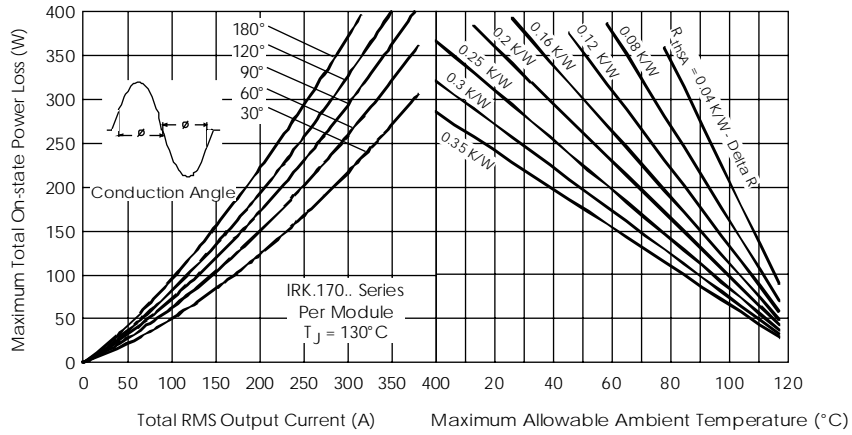

Fig. 7 - On-state Power Loss Characteristics

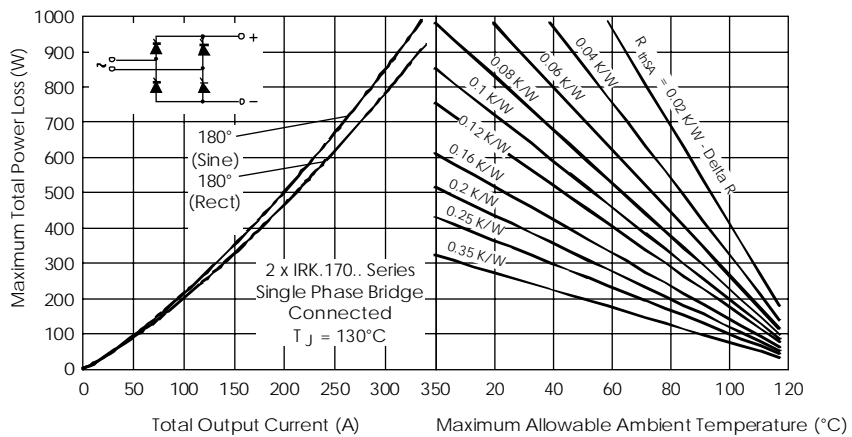

Fig. 8 - On-state Power Loss Characteristics

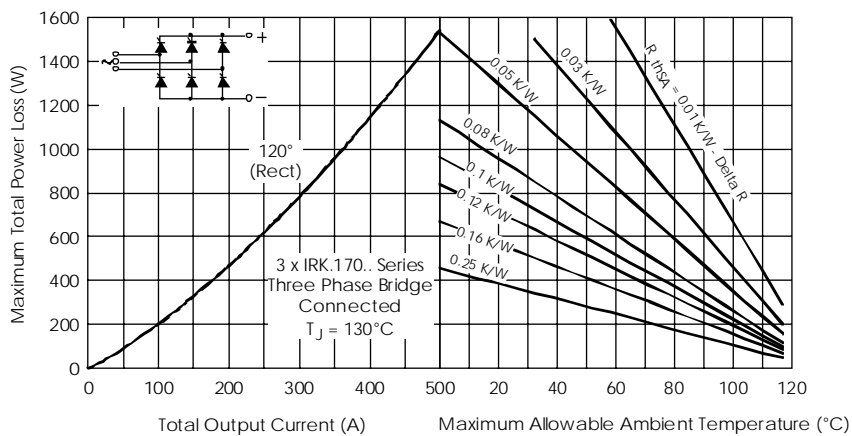

Fig. 9 - On-state Power Loss Characteristics

IRK.170, .230, .250 Series

Bulletin I27102 rev. A 10/97

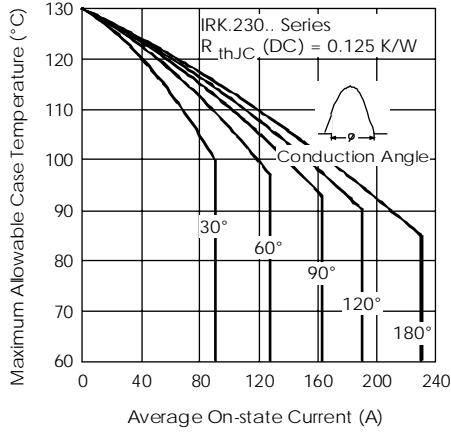

Fig. 10 - Current Ratings Characteristics

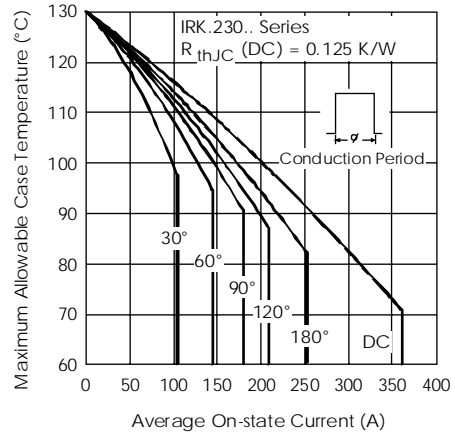

Fig. 11 - Current Ratings Characteristics

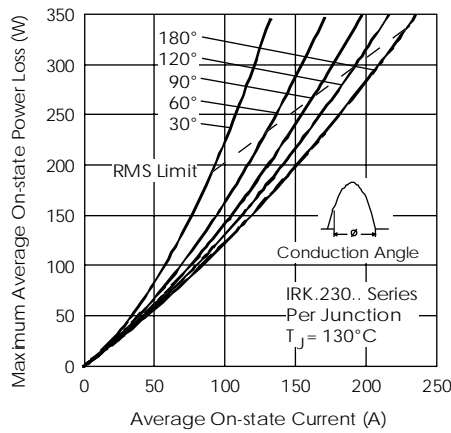

Fig. 12 - On-state Power Loss Characteristics

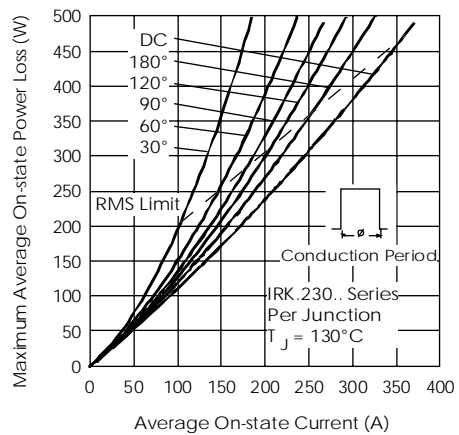

Fig. 13 - On-state Power Loss Characteristics

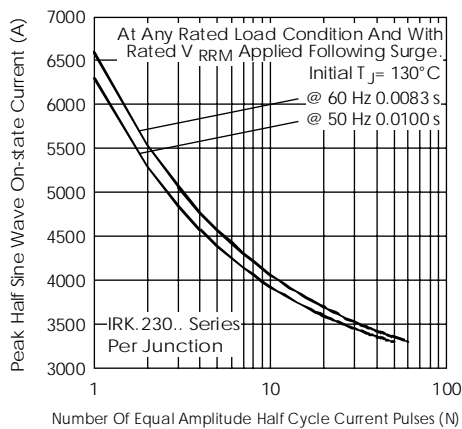

Fig. 14 - Maximum Non-Repetitive Surge Current

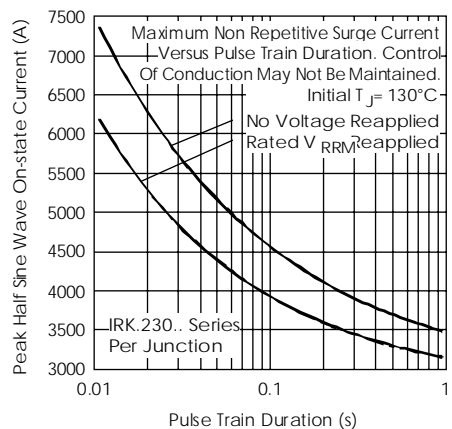

Fig. 15 - Maximum Non-Repetitive Surge Current

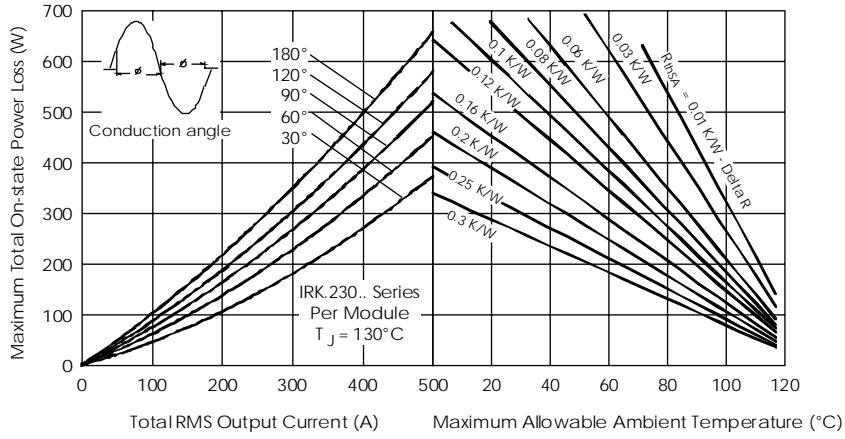

Fig. 16 - On-state Power Loss Characteristics

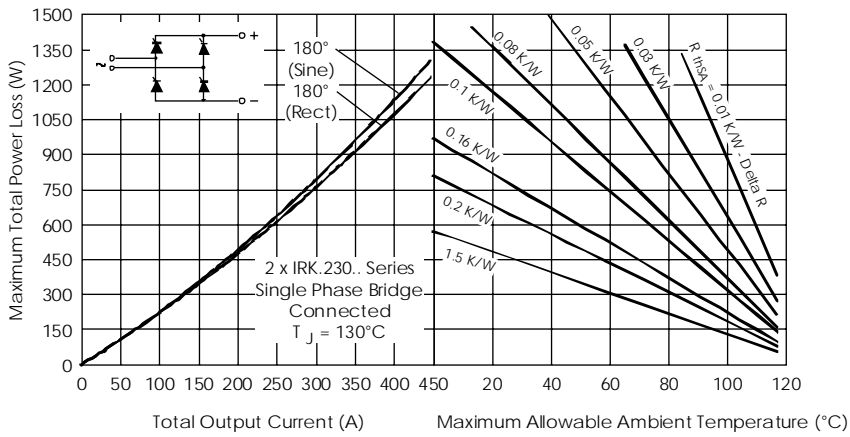

Fig. 17 - On-state Power Loss Characteristics

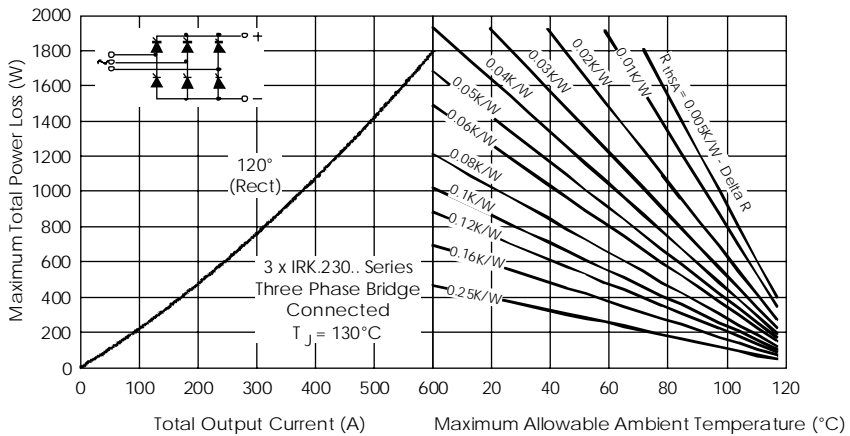

Fig. 18 - On-state Power Loss Characteristics

IRK.170, .230, .250 Series

Bulletin I27102 rev. A 10/97

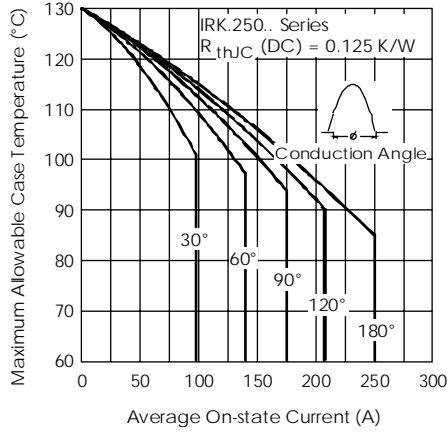

Fig. 19 - Current Ratings Characteristics

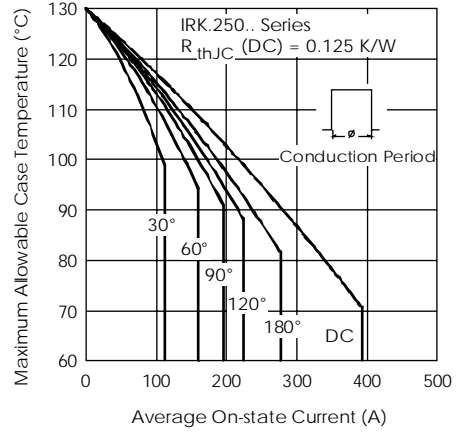

Fig. 20 - Current Ratings Characteristics

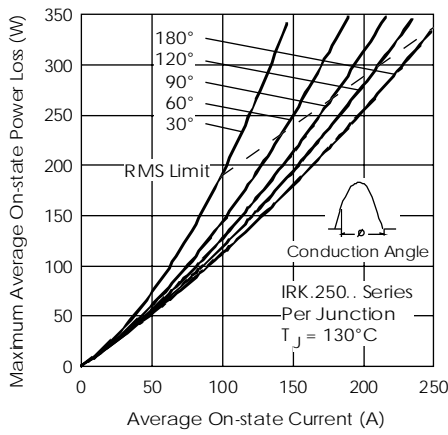

Fig. 21 - On-state Power Loss Characteristics

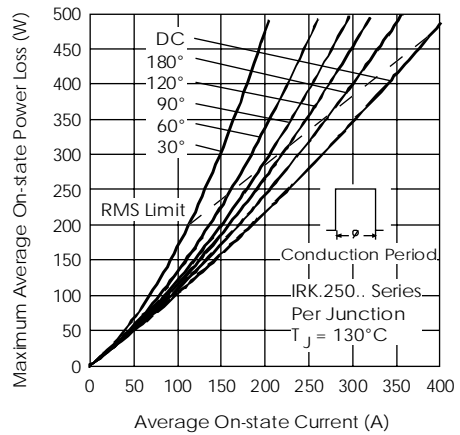

Fig. 22 - On-state Power Loss Characteristics

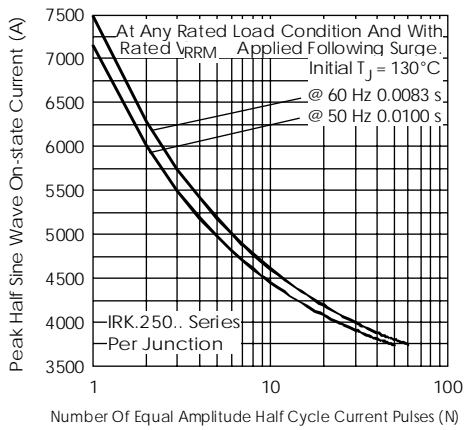

Fig. 23 - Maximum Non-Repetitive Surge Current

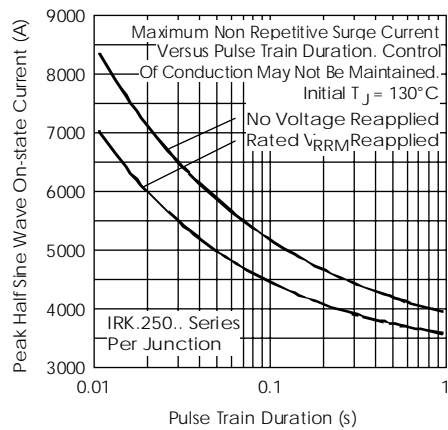

Fig. 24 - Maximum Non-Repetitive Surge Current

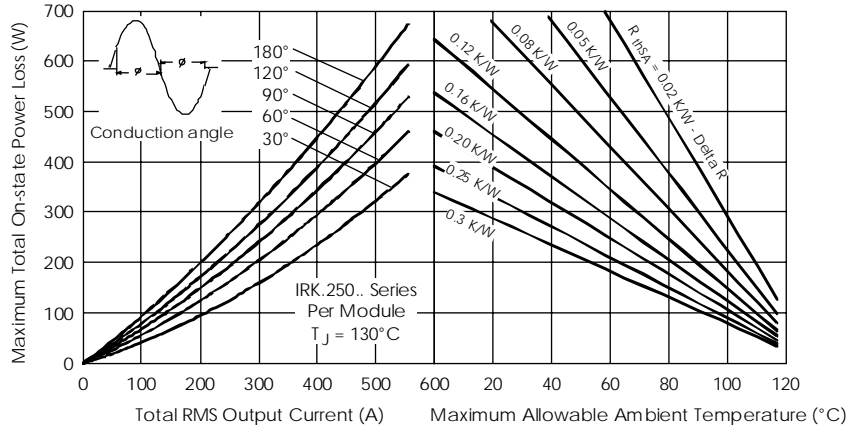

Fig. 25 - On-state Power Loss Characteristics

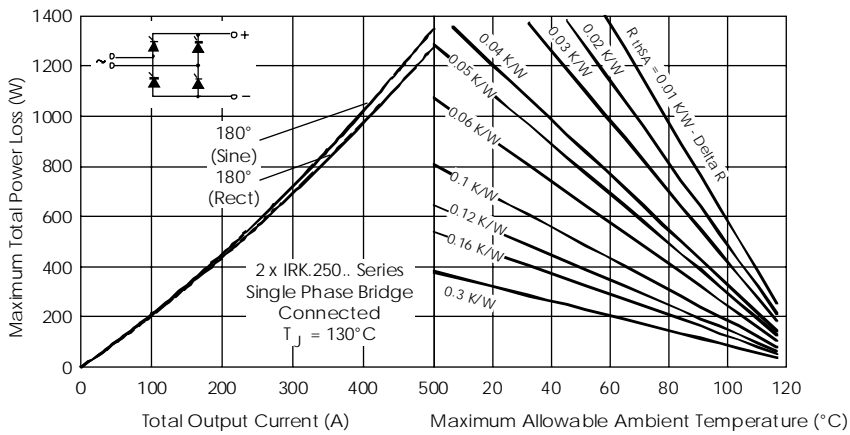

Fig. 26 - On-state Power Loss Characteristics

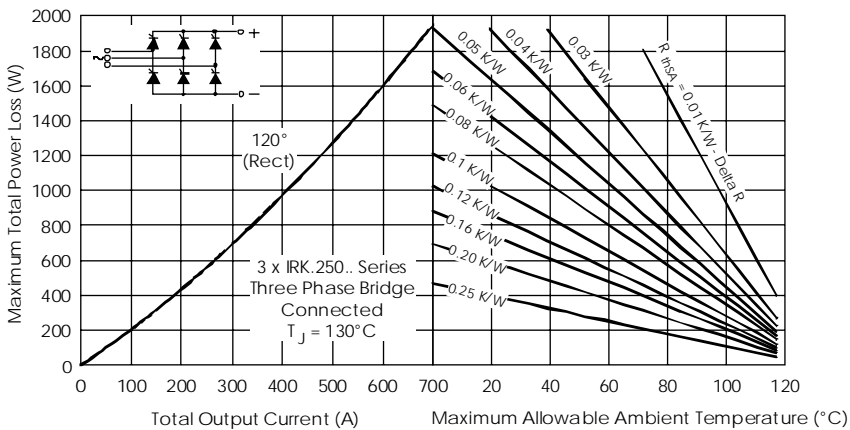

Fig.27 - On-state Power Loss Characteristics

IRK.170, .230, .250 Series

Bulletin I27102 rev. A 10/97

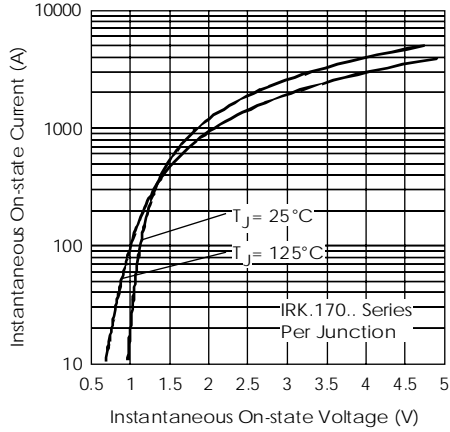

Fig. 28 - On-state Voltage Drop Characteristics

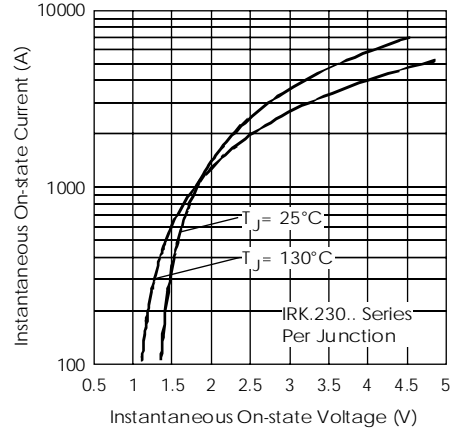

Fig. 29 - On-state Voltage Drop Characteristics

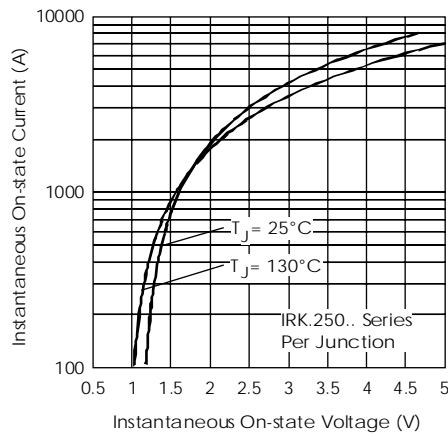

Fig. 30 - On-state Voltage Drop Characteristics

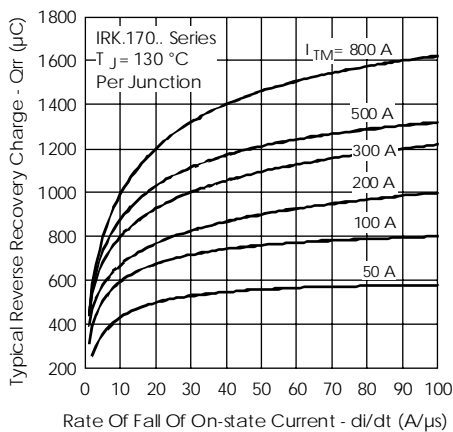

Fig. 31 - Reverse Recovery Charge Characteristics

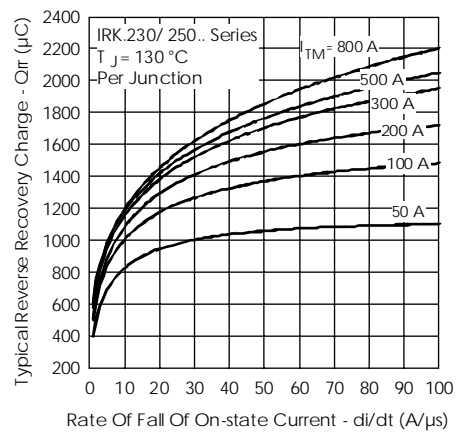

Fig. 32 - Reverse Recovery Charge Characteristics

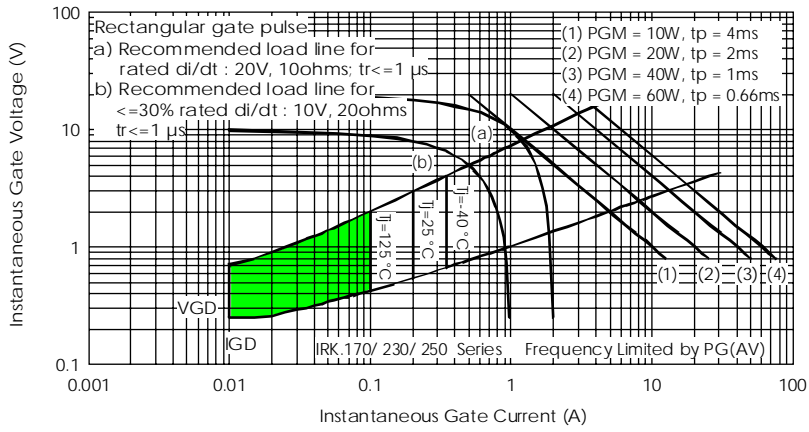

Fig. 33 - Gate Characteristics

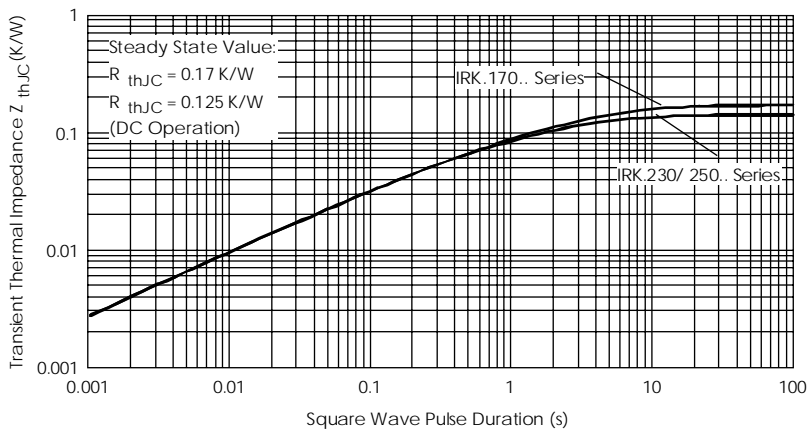

Fig. 34 - Thermal Impedance Z_{thJC} Characteristics