

**800mA LOW DROPOUT LINEAR REGULATOR****AZ1117B****General Description**

The AZ1117B is a low dropout three-terminal regulator with a dropout of 1.2V at 800mA output current.

The AZ1117B has been optimized for low voltage where transient response and minimum input voltage are critical. It provides current limit and thermal shutdown. Its circuit includes a trimmed bandgap reference to assure output voltage accuracy to be within  $\pm 1\%$ . On-chip thermal shutdown provides protection against a combination of high current and ambient temperature that would create excessive junction temperature.

The AZ1117B is available in 1.8V, 2.5V and 3.3V versions. The fixed versions integrate the adjust resistors. It is also available in an adjustable version which can set the output voltage with two external resistors.

The AZ1117B is available in the industry-standard SOT-223 power package.

**Features**

- Low Dropout Voltage: 1.2V at 800mA Output Current
- Output Noise from 10Hz to 10KHz: 0.003% of  $V_{OUT}$
- PSRR at  $I_{OUT}=300mA$  and  $f=120Hz$ : 70dB
- Output Voltage Accuracy:  $\pm 1\%$
- On-chip Thermal Shutdown
- Maximum Quiescent Current:  $I_{QMAX}=6mA$
- Operation Junction Temperature: -20 to 105°C

**Applications**

- USB Device
- Add-on Card
- DVD Player
- PC Motherboard

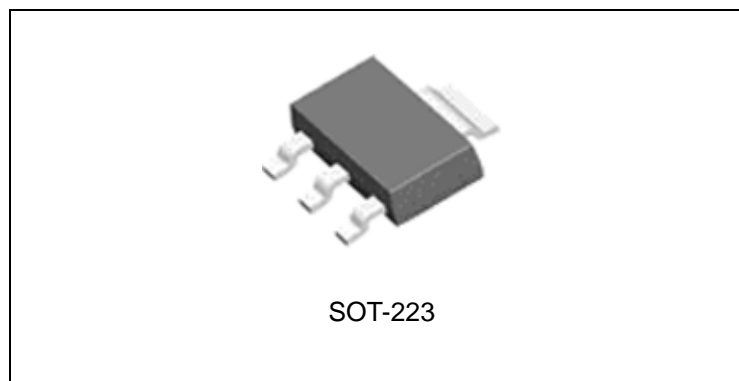

Figure 1. Package Type of AZ1117B



**800mA LOW DROPOUT LINEAR REGULATOR**

**AZ1117B**

**Pin Configuration**

H Package  
(SOT-223)

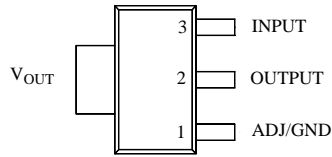

Figure 2. Pin Configuration of AZ1117B (Top View)

**Functional Block Diagram**

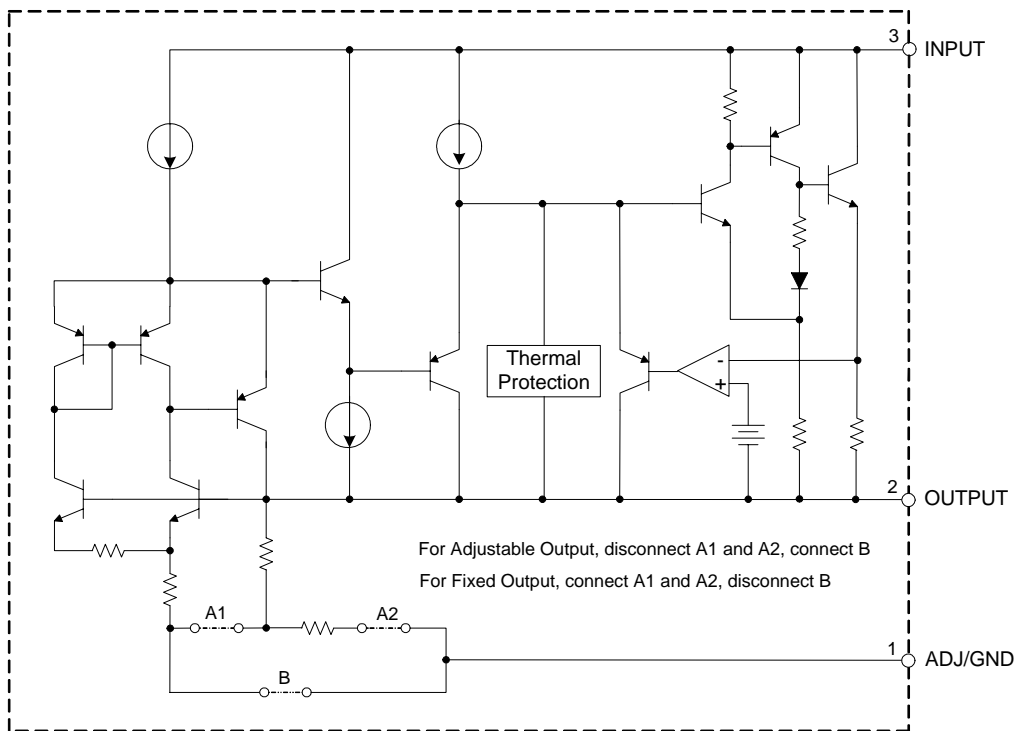

Figure 3. Functional Block Diagram of AZ1117B



**800mA LOW DROPOUT LINEAR REGULATOR**

**AZ1117B**

**Ordering Information**

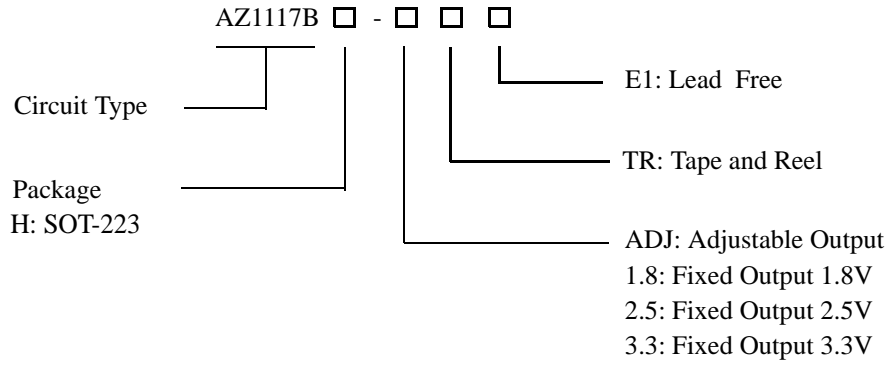

Package	Temperature Range	Part Number	Marking ID	Packing Type
SOT-223	-20 to 105°C	AZ1117BH-ADJTRE1	EH17K	Tape & Reel
		AZ1117BH-1.8TRE1	EH17L	Tape & Reel
		AZ1117BH-2.5TRE1	EH17N	Tape & Reel
		AZ1117BH-3.3TRE1	EH17M	Tape & Reel

BCD Semiconductor's Pb-free products, as designated with "E1" suffix in the part number, are RoHS compliant.

**800mA LOW DROPOUT LINEAR REGULATOR****AZ1117B****Absolute Maximum Ratings (Note 1)**

Parameter	Symbol	Value	Unit
Input Voltage	$V_{IN}$	18	V
Operating Junction Temperature Range	$T_J$	150	°C
Storage Temperature Range	$T_{STG}$	-65 to 150	°C
Lead Temperature (Soldering, 10sec)	$T_{LEAD}$	260	°C

Note 1: Stresses greater than those listed under "Absolute Maximum Ratings" may cause permanent damage to the device. These are stress ratings only, and functional operation of the device at these or any other conditions beyond those indicated under "Recommended Operating Conditions" is not implied. Exposure to "Absolute Maximum Ratings" for extended periods may affect device reliability.

**Recommended Operating Conditions**

Parameter	Symbol	Min	Max	Unit
Input Voltage	$V_{IN}$		12	V
Operating Junction Temperature Range	$T_J$	-20	105	°C



**800mA LOW DROPOUT LINEAR REGULATOR**

**AZ1117B**

**Electrical Characteristics**

**AZ1117B-ADJ Electrical Characteristics**

Operating Conditions:  $V_{IN}=V_{OUT}+2V$ ,  $I_{OUT}=10mA$ ,  $T_J=25^{\circ}C$ , unless otherwise specified. ( $P \leq$  maximum power dissipation).

Limits appearing in **Boldface** type apply over the entire junction temperature range for operation,  $-20^{\circ}C$  to  $105^{\circ}C$ .

Parameter	Symbol	Conditions	Min	Typ	Max	Unit
Reference Voltage	$V_{REF}$		1.238	1.250	1.262	V
		$10mA \leq I_{OUT} \leq 800mA$ , $1.5V \leq V_{IN} - V_{OUT} \leq 10V$	<b>1.225</b>	1.250	<b>1.270</b>	
Line Regulation	$V_{RLINE}$	$1.5V \leq V_{IN} - V_{OUT} \leq 10V$		0.001	0.1	%
					<b>0.2</b>	
Load Regulation	$V_{RLOAD}$			0.4	1.0	%
Dropout Voltage	$V_{DROP}$	$\Delta V_{REF}=1\%$ , $I_{OUT}=0.8A$		1.2	<b>1.3</b>	V
Current Limit	$I_{LIMIT}$		0.85	1	1.15	A
Adjust Pin Current				60	<b>120</b>	$\mu A$
Adjust Pin Current Change		$1.5V \leq (V_{IN} - V_{OUT}) \leq 10V$ , $10mA \leq I_{OUT} \leq 800mA$		0.2	<b>5</b>	$\mu A$
Minimum Load Current		$1.5V \leq (V_{IN} - V_{OUT}) \leq 10V$		1.7	<b>5</b>	mA
Ripple Rejection	PSRR	$f=120Hz$ , $C_{OUT}=22\mu F$ $(V_{IN} - V_{OUT})=3V$ , $I_{OUT}=300mA$		70		dB
Temperature Stability				0.5		%
RMS Output Noise (% of $V_{OUT}$ )		$T_A=25^{\circ}C$ , $10Hz \leq f \leq 10KHz$		0.003		%
Thermal Shutdown		Junction Temperature		160		$^{\circ}C$
Thermal Shutdown Hysteresis				16		$^{\circ}C$

**800mA LOW DROPOUT LINEAR REGULATOR****AZ1117B****Electrical Characteristics (Continued)****AZ1117B-1.8 Electrical Characteristics**

Operating Conditions:  $V_{IN}=3.8V$ ,  $I_{OUT}=10mA$ ,  $T_J=25^{\circ}C$ , unless otherwise specified. ( $P \leq$  maximum power dissipation). Limits appearing in **Boldface** type apply over the entire junction temperature range for operation,  $-20^{\circ}C$  to  $105^{\circ}C$ .

Parameter	Symbol	Conditions	Min	Typ	Max	Unit
Output Voltage	$V_{OUT}$		1.782	1.8	1.818	V
		$10mA \leq I_{OUT} \leq 800mA$ , $3.8V \leq V_{IN} \leq 10V$	<b>1.764</b>	1.8	<b>1.836</b>	
Line Regulation	$V_{RLINE}$	$1.5V \leq V_{IN} - V_{OUT} \leq 10V$		0.5	6	mV
					<b>10</b>	
Load Regulation	$V_{RLOAD}$			2	15	mV
Dropout Voltage	$V_{DROP}$	$\Delta V_{OUT}=1\%$ , $I_{OUT}=0.8A$		1.2	<b>1.3</b>	V
Current Limit	$I_{LIMIT}$		0.85	1	1.15	A
Quiescent Current	$I_Q$	$I_{OUT}=0$		4	<b>6</b>	mA
Ripple Rejection	PSRR	$f=120Hz$ , $C_{OUT}=22\mu F$ $(V_{IN}-V_{OUT})=3V$ , $I_{OUT}=300mA$		70		dB
Temperature Stability				0.5		%
RMS Output Noise (% of $V_{OUT}$ )		$T_A=25^{\circ}C$ , $10Hz \leq f \leq 10KHz$		0.003		%
Thermal Shutdown		Junction Temperature		160		$^{\circ}C$
Thermal Shutdown Hysteresis				16		$^{\circ}C$

**800mA LOW DROPOUT LINEAR REGULATOR****AZ1117B****Electrical Characteristics (Continued)****AZ1117B-2.5 Electrical Characteristics**

Operating Conditions:  $V_{IN}=4.5V$ ,  $I_{OUT}=10mA$ ,  $T_J=25^{\circ}C$ , unless otherwise specified. ( $P \leq$  maximum power dissipation). Limits appearing in **Boldface** type apply over the entire junction temperature range for operation,  $-20^{\circ}C$  to  $105^{\circ}C$ .

Parameter	Symbol	Conditions	Min	Typ	Max	Unit
Output Voltage	$V_{OUT}$		2.475	2.5	2.525	V
		$10mA \leq I_{OUT} \leq 800mA$ , $4.5V \leq V_{IN} \leq 10V$	<b>2.455</b>	<b>2.5</b>	<b>2.545</b>	
Line Regulation	$V_{RLINE}$	$1.5V \leq V_{IN} - V_{OUT} \leq 10V$		0.5	6	mV
					<b>10</b>	
Load Regulation	$V_{RLOAD}$			2	15	mV
Dropout Voltage	$V_{DROP}$	$\Delta V_{OUT}=1\%$ , $I_{OUT}=0.8A$		1.2	<b>1.3</b>	V
Current Limit	$I_{LIMIT}$		0.85	1	1.15	A
Quiescent Current	$I_Q$	$I_{OUT}=0$		4	<b>6</b>	mA
Ripple Rejection	PSRR	$f=120Hz$ , $C_{OUT}=22\mu F$ $(V_{IN}-V_{OUT})=3V$ , $I_{OUT}=300mA$		70		dB
Temperature Stability				0.5		%
RMS Output Noise (% of $V_{OUT}$ )		$T_A=25^{\circ}C$ , $10Hz \leq f \leq 10KHz$		0.003		%
Thermal Shutdown		Junction Temperature		160		$^{\circ}C$
Thermal Shutdown Hysteresis				16		$^{\circ}C$

**800mA LOW DROPOUT LINEAR REGULATOR****AZ1117B****Electrical Characteristics (Continued)****AZ1117B-3.3 Electrical Characteristics**

Operating Conditions:  $V_{IN}=5.3V$ ,  $I_{OUT}=10mA$ ,  $T_J=25^{\circ}C$ , unless otherwise specified. ( $P \leq$  maximum power dissipation). Limits appearing in **Boldface** type apply over the entire junction temperature range for operation,  $-20^{\circ}C$  to  $105^{\circ}C$ .

Parameter	Symbol	Conditions	Min	Typ	Max	Unit
Output Voltage	$V_{OUT}$		3.267	3.3	3.333	V
		$10mA \leq I_{OUT} \leq 800mA$ , $5.3V \leq V_{IN} \leq 10V$	<b>3.235</b>	3.3	<b>3.365</b>	
Line Regulation	$V_{RLINE}$	$1.5V \leq V_{IN} - V_{OUT} \leq 10V$		0.5	6	mV
					<b>10</b>	
Load Regulation	$V_{RLOAD}$			2	15	mV
Dropout Voltage	$V_{DROP}$	$\Delta V_{OUT}=1\%$ , $I_{OUT}=0.8A$		1.2	<b>1.3</b>	V
Current Limit	$I_{LIMIT}$		0.85	1	1.15	A
Quiescent Current	$I_Q$	$I_{OUT}=0$		4	<b>6</b>	mA
Ripple Rejection	PSRR	$f=120Hz$ , $C_{OUT}=22\mu F$ $(V_{IN}-V_{OUT})=3V$ , $I_{OUT}=300mA$		70		dB
Temperature Stability				0.5		%
RMS Output Noise (% of $V_{OUT}$ )		$T_A=25^{\circ}C$ , $10Hz \leq f \leq 10KHz$		0.003		%
Thermal Shutdown		Junction Temperature		160		$^{\circ}C$
Thermal Shutdown Hysteresis				16		$^{\circ}C$





**800mA LOW DROPOUT LINEAR REGULATOR**

**AZ1117B**

**Typical Performance Characteristics**

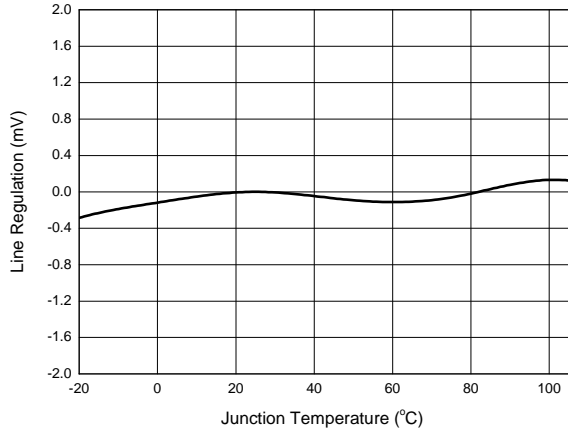

Figure 4. Line Regulation vs. Junction Temperature

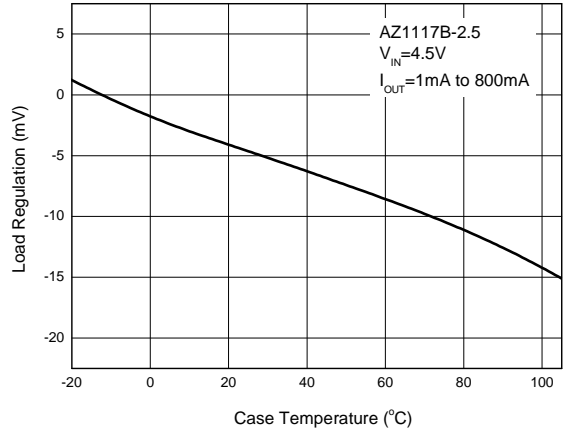

Figure 5. Load Regulation vs. Case Temperature

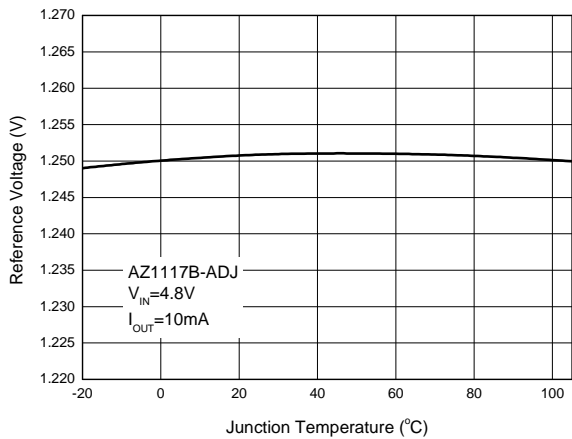

Figure 6. Reference Voltage vs. Junction Temperature

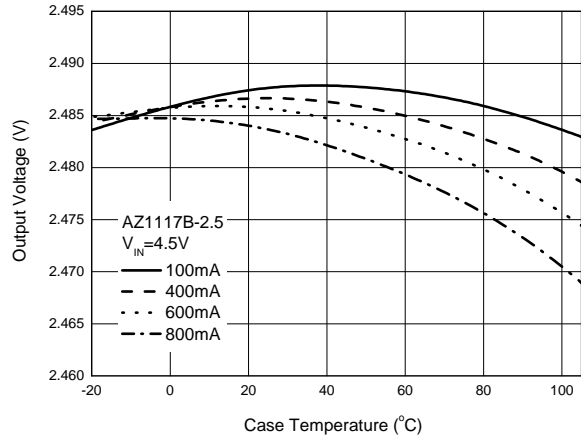

Figure 7. Output Voltage vs. Case Temperature



**800mA LOW DROPOUT LINEAR REGULATOR**

**AZ1117B**

**Typical Performance Characteristics (Continued)**

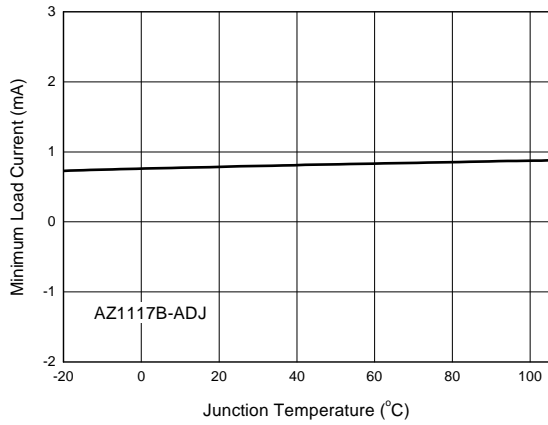

Figure 8. Minimum Load Current vs. Junction Temperature

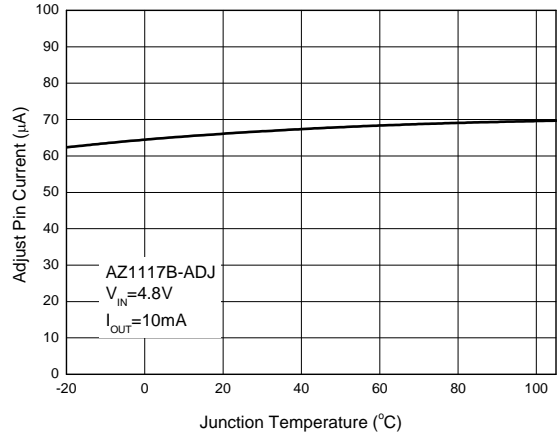

Figure 9. Adjust Pin Current vs. Junction Temperature

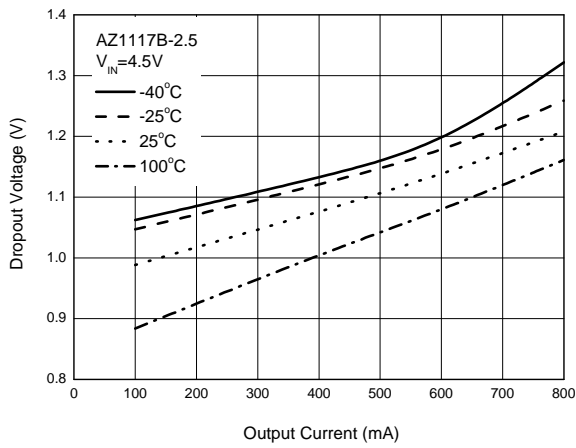

Figure 10. Dropout Voltage vs. Output Current

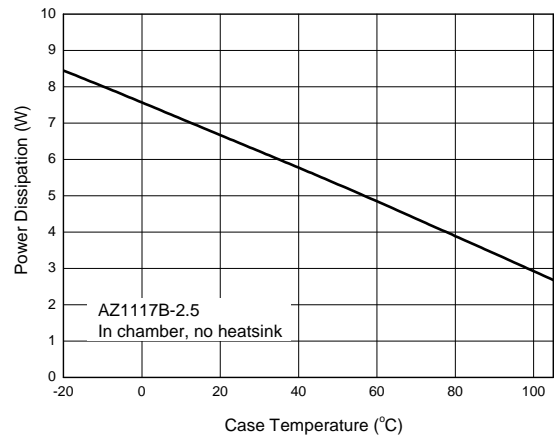

Figure 11. Power Dissipation vs. Case Temperature



**800mA LOW DROPOUT LINEAR REGULATOR**

**AZ1117B**

**Typical Performance Characteristics (Continued)**

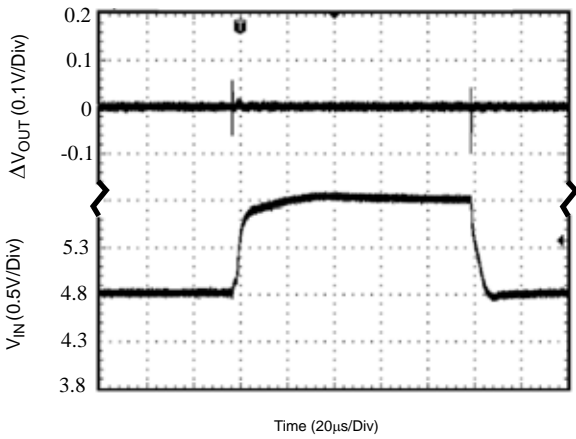

Figure 12. Line Transient Response

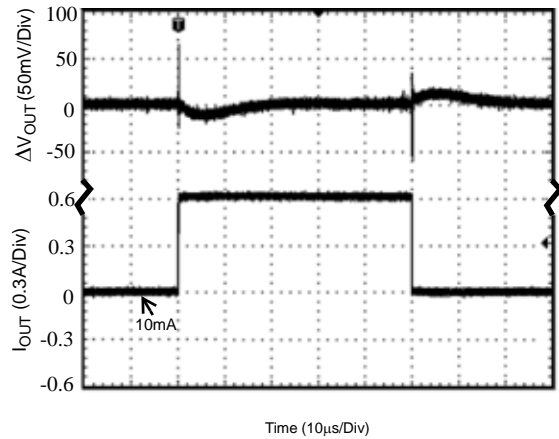

Figure 13. Load Transient Response

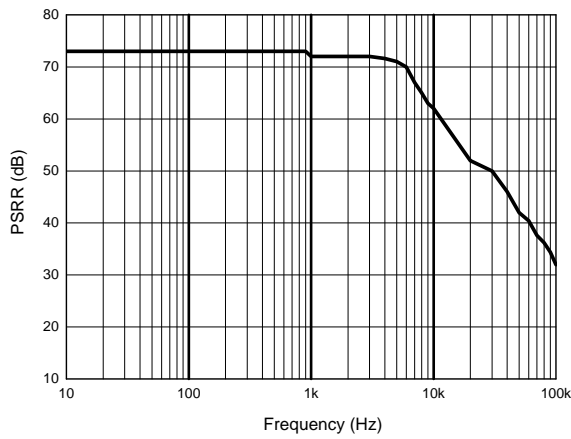

Figure 14. PSRR vs. Frequency

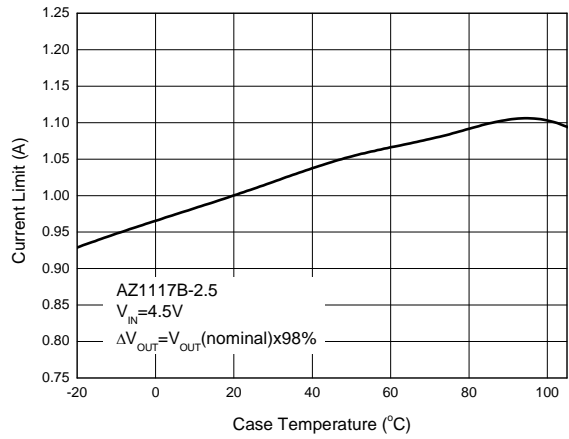

Figure 15. Current Limit vs. Case Temperature



**800mA LOW DROPOUT LINEAR REGULATOR**

**AZ1117B**

**Typical Performance Characteristics (Continued)**

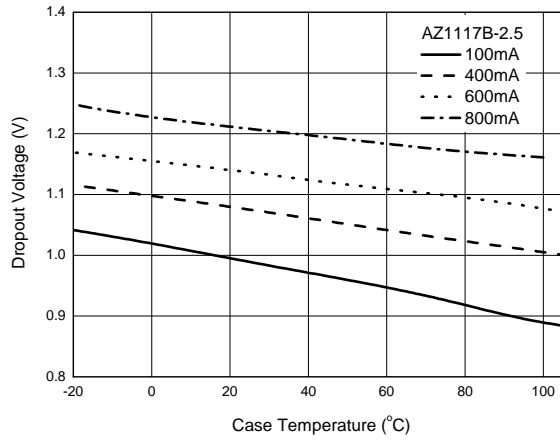

Figure 16. Dropout Voltage vs. Case Temperature

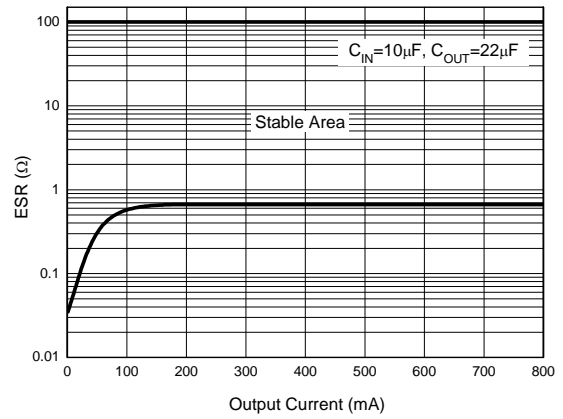

Figure 17. ESR vs. Output Current



**800mA LOW DROPOUT LINEAR REGULATOR**

**AZ1117B**

**Typical Applications**

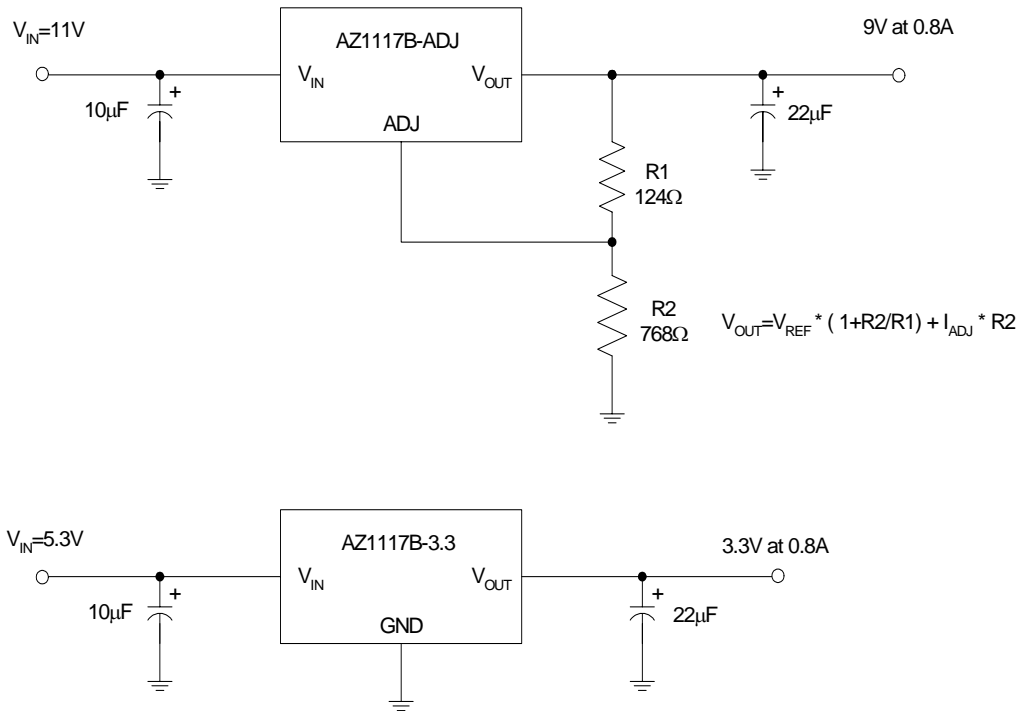

Figure 18. Typical Applications of AZ1117B



**800mA LOW DROPOUT LINEAR REGULATOR**

**AZ1117B**

**Mechanical Dimensions**

**SOT-223**

**Unit: mm(inch)**

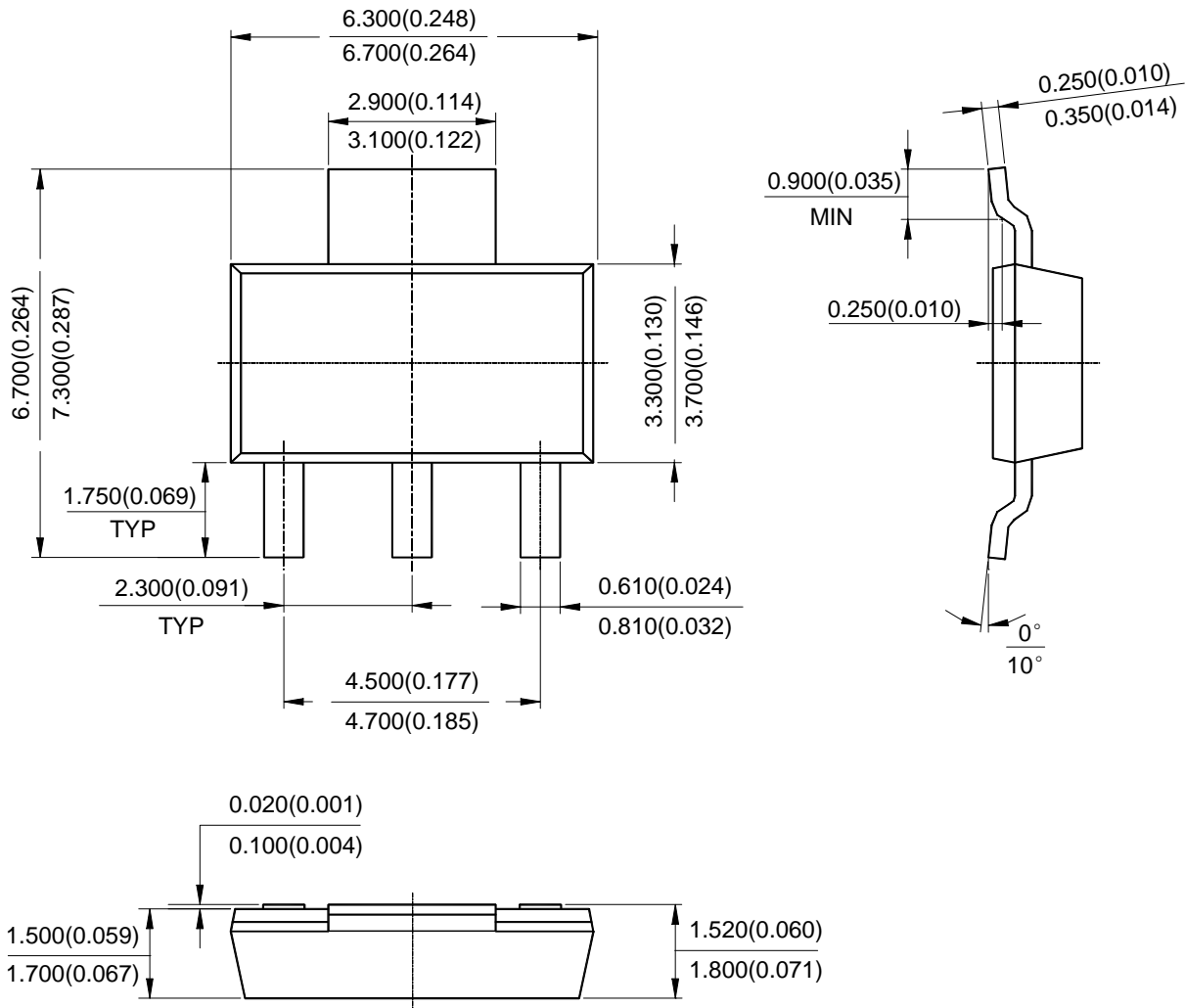



BCD Semiconductor Manufacturing Limited

<http://www.bcdsemi.com>

#### IMPORTANT NOTICE

BCD Semiconductor Manufacturing Limited reserves the right to make changes without further notice to any products or specifications herein. BCD Semiconductor Manufacturing Limited does not assume any responsibility for use of any its products for any particular purpose, nor does BCD Semiconductor Manufacturing Limited assume any liability arising out of the application or use of any its products or circuits. BCD Semiconductor Manufacturing Limited does not convey any license under its patent rights or other rights nor the rights of others.

---

#### MAIN SITE

**BCD Semiconductor Manufacturing Limited**  
- Wafer Fab  
Shanghai SIM-BCD Semiconductor Manufacturing Limited  
800, Yi Shan Road, Shanghai 200233, China  
Tel: +86-21-6485 1491, Fax: +86-21-5450 0008

**BCD Semiconductor Manufacturing Limited**  
- IC Design Group  
Advanced Analog Circuits (Shanghai) Corporation  
8F, Zone B, 900, Yi Shan Road, Shanghai 200233, China  
Tel: +86-21-6495 9539, Fax: +86-21-6485 9673

#### REGIONAL SALES OFFICE

**Shenzhen Office**  
Shanghai SIM-BCD Semiconductor Manufacturing Co., Ltd. Shenzhen Office  
Advanced Analog Circuits (Shanghai) Corporation Shenzhen Office  
Room E, 5F, Noble Center, No.1006, 3rd Fuzhong Road, Futian District, Shenzhen 518026, China  
Tel: +86-755-8826 7951  
Fax: +86-755-8826 7865

**Taiwan Office**  
BCD Semiconductor (Taiwan) Company Limited  
4F, 298-1, Rui Guang Road, Nei-Hu District, Taipei,  
Taiwan  
Tel: +886-2-2656 2808  
Fax: +886-2-2656 2806

**USA Office**  
BCD Semiconductor Corporation  
30920 Huntwood Ave. Hayward,  
CA 94544, U.S.A  
Tel : +1-510-324-2988  
Fax: +1-510-324-2788