

On-Board Type (DC) EMI Suppression Filters (EMIFIL[®])

Murata EMC Solutions : <http://www.murata.com/emc/>

EMI SUPPRESSION FILTERS

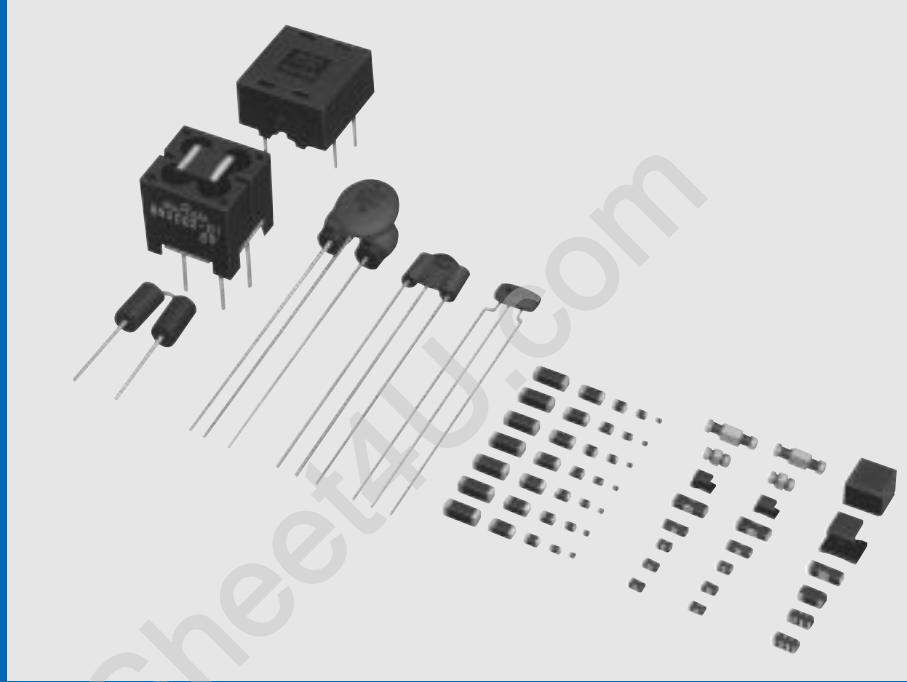

*Innovator
in Electronics*

Murata
Manufacturing Co., Ltd.

Cat.No.C31E-9

CONTENTS

EMIFIL®, EMIGUARD®, "EMIFIL" and "EMIGUARD" in this catalog are the trademarks of Murata Manufacturing Co., Ltd.

Selection Guide of EMI Filters	2
Products Guide / Effective Frequency Range	3
Outlines of EMI Suppression Filter (EMIFIL®) for DC Line	6
1 Chip Ferrite Beads Part Numbering / Impedance Map / BLM Series Line Up	12
●BLM03A/15A/18A/21A/31A/41A	18
●BLM15B/18B/21B/31B	27
●BLM18R/21R	41
●BLM18P/21P/31P/41P	45
●For GHz Range Noise Suppression BLM18H/18E	53
●Array Type BLA2AA/2AB/31A/31B	60
2 Chip EMIFIL® Part Numbering	66
●Capacitor Type NFM18C/21C/3DC/41C	70
●Capacitor Array NFA31C	74
●RC Combined Type NFR21G	75
●RC Combined Array Type NFA31G	79
●LC Combined Monolithic Type NFL18ST/18SP/21SP	81
●LC Combined Winding Type NFW31S	84
●LC Combined Type for Large Current NFE31P/61P/61H	86
●For Large Current NFM18P/21P/3DP/41P	89
3 Chip EMIGUARD® (EMIFIL® with Varistor Function) Part Numbering	93
●VFM41R	94
4 Chip Common Mode Choke Coils Part Numbering	96
●Film Type DLP11S/DLP31S	97
●Film Type Array DLP31D	99
●Monolithic Type DLM2HG	100
●Winding Type DLW21S/DLW21H/DLW31S	101
●Winding Type for Large Current DLW5AH/DLW5BS	104
5 Lead Type EMI Suppression Filters (EMIFIL®)	
Ferrite Beads Inductors Part Numbering	
●BL01/BL02/BL03	105
Disc Type EMIFIL® Part Numbering	
●DS□6/Broad Band DS□9N/Heavy-duty Type DS□9H	109
EMIGUARD® (EMIFIL® with Varistor Function) Part Numbering	
●VFR3V/VFS6V/VFS9V	117
Block Type EMIFIL®	
●BNX	125
Common Mode Choke Coils Part Numbering	
●PLT09H	127
6 Microwave Absorbers Part Numbering	129
●EA10/EA20/EA21	130
⚠Caution / Notice	132
Soldering and Mounting	134
Packaging	143
Chip EMI Suppression Filter Design Kits	147
Outlines of Major Noise Regulation Standards	152
Noise Suppression Principles by DC EMIFIL®	157
Murata EMI Filter Selection Simulator	161

Selection Guide of EMI Filters

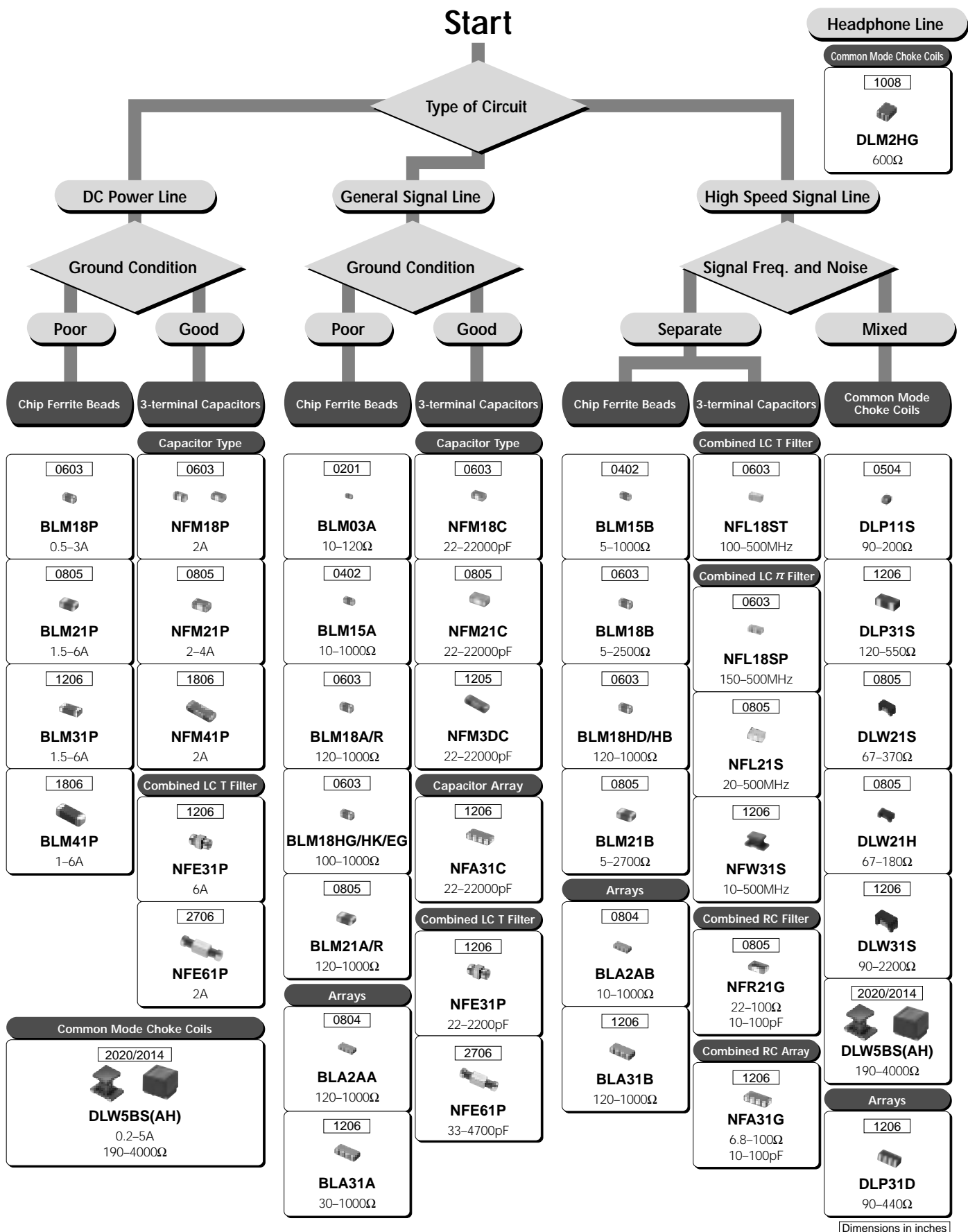

Headphone Line

Common Mode Choke Coils

1008



DLM2HG
600Ω

Dimensions in inches

High Current EMI Filters

Standard EMI Filters

EMI Filters for High Speed Signal Lines

Impedance is typical value at 100MHz.

Products Guide/Effective Frequency Range

Product Guide

Inductor Type	Type	Series	Dimensions		Effective Frequency Range														
			(mm)	EIA Code	10kHz	100kHz	1MHz	10MHz	100MHz	1GHz	10GHz								
Inductor Type	For Digital Interfaces	BLM18R	1.6 ±0.8	0603															
		BLM21R	2.0 ±1.25	0805															
	Standard	BLM03A	0.6 ±0.3	0201															
		BLM15A	1.0 ±0.5	0402															
		BLM18A	1.6 ±0.8	0603															
		BLM21A	2.0 ±1.25	0805															
		BLM31A	3.2 ±1.6	1206															
		BLM41A	4.5 ±1.6	1806															
		BLA2AA (4 circuits array)	2.0 ±1.0	0804															
		BLA31A (4 circuits array)	3.2 ±1.6	1206															
		For High Speed Signals	BLM15B	1.0 ±0.5	0402														
	BLM18B		1.6 ±0.8	0603															
	BLM21B		2.0 ±1.25	0805															
	BLM31B		3.2 ±1.6	1206															
	BLA2AB (4 circuits array)		2.0 ±1.0	0804															
	BLA31B (4 circuits array)		3.2 ±1.6	1206															
	For High Current	BLM18P	1.6 ±0.8	0603															
		BLM21P	2.0 ±1.25	0805															
		BLM31P	3.2 ±1.6	1206															
BLM41P		4.5 ±1.6	1806																
For GHz Range Noise Suppression	BLM18HG	1.6 ±0.8	0603																
	BLM18HB	1.6 ±0.8	0603																
	BLM18HD	1.6 ±0.8	0603																
	BLM18HK	1.6 ±0.8	0603																
	BLM18EG	1.6 ±0.8	0603																

Continued on the following page.

Products Guide/Effective Frequency Range





Continued from the preceding page.

Type	Series	Dimensions		Effective Frequency Range								
		(mm)	EIA Code	10kHz	100kHz	1MHz	10MHz	100MHz	1GHz	10GHz		
Capacitor Type	Standard Type	NFM18C	1.6 ±0.8	0603								
		NFM21C	2.0 ±1.25	0805								
		NFM3DC	3.2 ±1.25	1205								
		NFM41C	4.5 ±1.6	1806								
		NFA31C (4 circuits array)	3.2 ±1.6	1206								
	For Signal Lines	NFL18ST	1.6 ±0.8	0603								
		NFL18SP	1.6 ±0.8	0603								
		NFL21S	2.0 ±1.25	0805								
		NFR21G	2.0 ±1.25	0805								
		NFA31G (4 circuits array)	3.2 ±1.6	1206								
		NFW31S	3.2 ±1.6	1206								
	For High Current	NFM18P	1.6 ±0.8	0603								
		NFM21P	2.0 ±1.25	0805								
		NFM3DP	3.2 ±1.25	1205								
		NFM41P	4.5 ±1.6	1806								
	T Filter for High Current	NFE31P	3.2 ±1.6	1206								
		NFE61P(H)	6.8 ±1.6	2706								
	With Varistor Function	VFM41R	4.5 ±1.6	1806								
	Common Mode Choke Coils	DLP11S	1.25 ±1.0	0504								
		DLP31S	3.2 ±1.6	1206								
DLP31D		3.2 ±1.6	1206									
DLM2HG		2.5 ±2.0	1008									
DLW21S		2.0 ±1.2	0805									
DLW21H		2.0 ±1.2	0805									
DLW31S		3.2 ±1.6	1206									
DLW5BS (DLW5AH)		5.0 ±5.0 (3.6)	2020 (2014)									

Continued on the following page. ↗

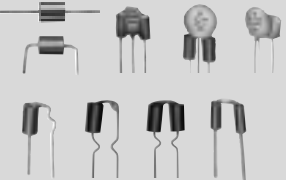
Products Guide/Effective Frequency Range

↳ Continued from the preceding page.

Type	Series	Dimensions		Effective Frequency Range								
		(mm)	EIA Code	10kHz	100kHz	1MHz	10MHz	100MHz	1GHz	10GHz		
Disc EMIFIL® 	BL01/02/03 DSN6/9(H) DSS6/9(H) DST9(H)											
EMIGUARD® (EMI Filters with varistor functions) 	VFR3V VFS6V/9V											
Block EMIFIL® 	BNX											
Common Mode Choke Coils 	PLT09H											
EMC Absorber 	EA10/20/21											

Outline of EMI Suppression Filters (EMIFIL[®]) for DC Line

- Chip Ferrite Bead
- Ferrite Bead Inductor

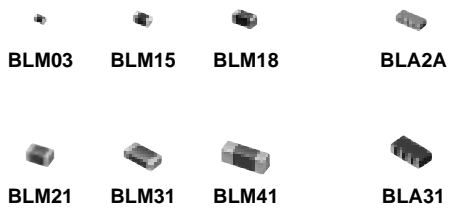
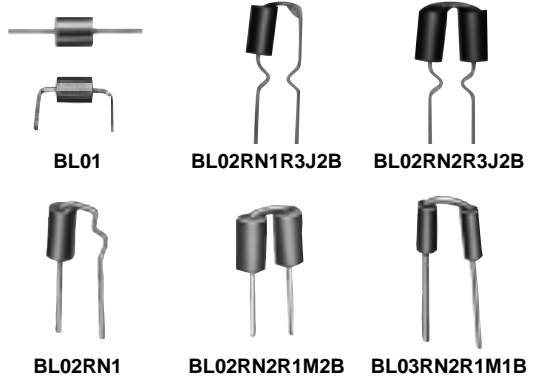
Chip Ferrite BeadP.18–65	Ferrite Bead InductorP.106–108
	

- Chip Ferrite Beads are effective for frequencies ranging from a few MHz to a few GHz. Chip Ferrite Beads are widely used as a low noise countermeasure, as well as a universal noise suppression component.
- Chip Ferrite Beads produce a micro inductance in the low frequency range. At high frequencies, however, the resistive component of the inductor produces the primary impedance. When inserted in series in the noise producing circuit, the resistive impedance of the inductor prevents noise propagation.

[Equivalent Circuit]

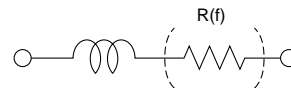



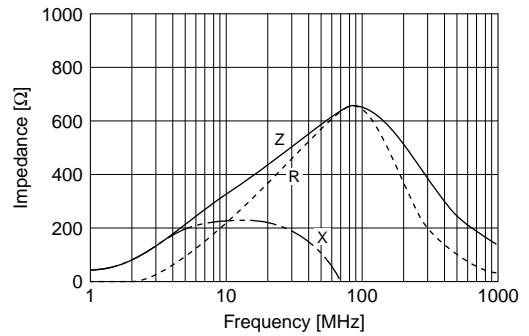





[Impedance-Frequency Characteristics (typical)]



R : Real Part (Resistive Portion) X : Imaginary Part (Inductive Portion)

Outline of EMI Suppression Filters (EMIFIL®) for DC Line

- Chip EMIFIL®
- T-type Chip EMIFIL®
- Disk Type EMIFIL®

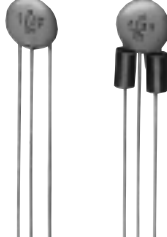
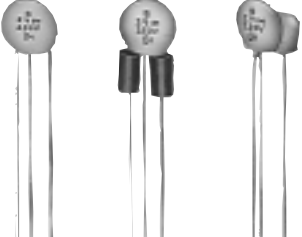
<p>Chip EMIFIL®P.70–73 P.74 P.89–92</p> <div style="display: flex; justify-content: space-around; align-items: center;"> <div style="text-align: center;">  NFM18P </div> <div style="text-align: center;">  NFM21C </div> <div style="text-align: center;">  NFM21P </div> </div> <div style="display: flex; justify-content: space-around; align-items: center; margin-top: 20px;"> <div style="text-align: center;">  NFM3DC </div> <div style="text-align: center;">  NFA31C </div> </div>	<p>T-type Chip EMIFIL®P.86–88</p> <div style="display: flex; justify-content: space-around; align-items: center; margin-top: 20px;"> <div style="text-align: center;">  NFE31P </div> <div style="text-align: center;">  NFE61P/H </div> </div>
<p>Disk Type EMIFIL®P.110–116</p> <div style="display: flex; justify-content: space-around; align-items: center; margin-top: 20px;"> <div style="text-align: center;">  DS□6 </div> <div style="text-align: center;">  DS□9 </div> <div style="text-align: center;">  DS□9H </div> </div>	

- This capacitor type EMI suppression filter has a large noise suppression effect at frequencies ranging from a few MHz to hundreds of MHz. This type of filter is used widely as a universal, high performance EMI suppression component.
- The chip EMIFIL® incorporates a built-in three-terminal capacitor, eliminating the lead wire and thereby increasing the high-frequency performance characteristic.
- The T-type chip EMIFIL® is a chip EMI suppression filter with a built-in feed-thru capacitor. The use of ferrite beads on input and output terminals minimizes resonance with surrounding circuits.
- Whatever the situation, 3-terminal construction reduces residual inductance, thereby substantially improving noise suppression at frequencies over 10MHz.

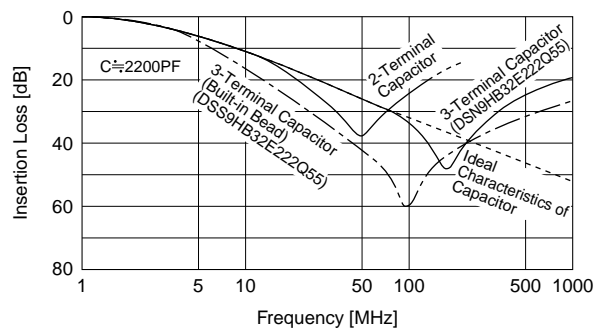

[Comparison of Insertion Loss Characteristics]



A 3-terminal capacitor has a higher self resonance frequency than a general 2-terminal type and exhibits effective noise suppression at high frequency.

Outline of EMI Suppression Filters (EMIFIL[®]) for DC Line

- Chip EMIFIL[®] for Signal Line
- Chip EMIFIL[®] with Waveform Distortion Suppressing Function

Chip EMIFIL [®] for Signal Line	P.30–39 P.53–56 P.81–85	Chip EMIFIL [®] with Waveform Distortion Suppressing Function	P.75–80
			
NFW31S	NFL18ST	NFL18SP	NFL21S
BLM18B/18HD	BLM21B	NFR21G	NFA31G

- High-speed signal application EMIFIL[®] are high performance EMI suppression filters which increase the slope of insertion loss frequency characteristic curves (shape factor), thereby improving noise and signal separation. These are used for high speed signal applications in which noise and signal frequency approach the same value.
To avoid the elimination of both the noise and specific signal components, 3-terminal capacitors and other components are applied.
An NFW31S with a built-in capacitor and an inductor type BLM□□B are available.
BLM18HD has additional performance for suppressing GHz range noise after cut off frequency.
- The EMIFIL[®] with waveform distortion suppressing function suppresses waveform distortion caused by the resonance of digital ICs and surrounding circuits.

[Comparison of Insertion Loss Characteristics]

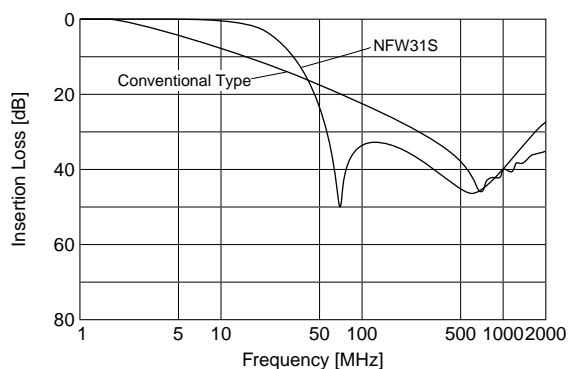

[Waveform change when filter is inserted]

Conventional Type
(Chip 3-terminal Capacitor)

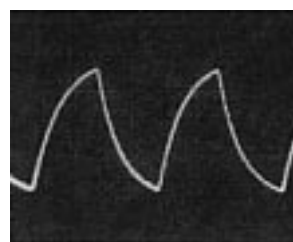



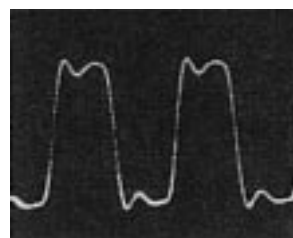







EMIFIL[®] for Signal Line
NFW31S series



Outline of EMI Suppression Filters (EMIFIL[®]) for DC Line

- Chip Common Mode Choke Coil
- Common Mode Choke Coil

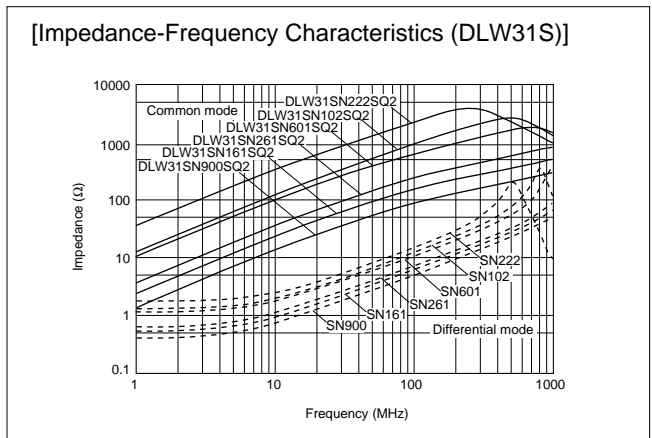
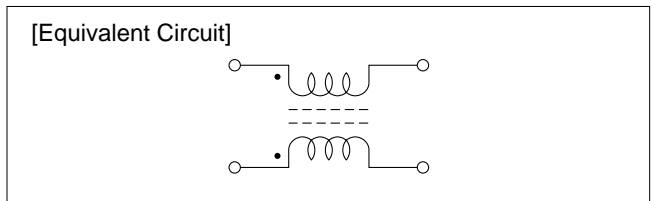
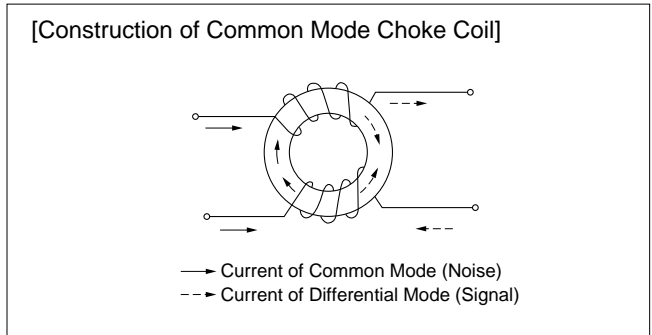

<p>Chip Common Mode Choke CoilP.97-104</p> <div style="display: flex; flex-wrap: wrap; justify-content: space-around; align-items: center;"> <div style="text-align: center; margin: 5px;">  DLW5AH </div> <div style="text-align: center; margin: 5px;">  DLW31S </div> <div style="text-align: center; margin: 5px;">  DLW21S </div> <div style="text-align: center; margin: 5px;">  DLW21H </div> <div style="text-align: center; margin: 5px;">  DLW31S </div> <div style="text-align: center; margin: 5px;">  DLM2HG </div> <div style="text-align: center; margin: 5px;">  DLP31D </div> <div style="text-align: center; margin: 5px;">  DLP31S </div> <div style="text-align: center; margin: 5px;">  DLP11S </div> </div>	<p>Common Mode Choke CoilP.128</p> <div style="text-align: center; margin: 20px;">  PLT09H </div>
--	--

- These choke coils reduce common mode noise, which causes problems on balanced transmission lines, and are effective against common mode noise in the several MHz to several 100 MHz frequency range. They are ideally suited for noise suppression on DC power supply lines and interface cables.



Outline of EMI Suppression Filters (EMIFIL[®]) for DC Line

- Chip EMIGUARD[®]
- EMIGUARD[®]

Chip EMIGUARD [®]P.94–95	EMIGUARD [®]P.118–124
 VFM41R	 VFR3V VFS6V VFS9V

- EMIGUARD[®] eliminates both surge noises and EMI noises due to its dielectric varistor material.
- Effective when high frequency noise and high voltage surge suppression are required, and also in situations when surging starts at extremely high speeds. This type of surging cannot be eliminated with general type varistors.
- VFM41R is chip type of EMIGUARD[®].

[Construction of EMIGUARD[®] (VFS9V)]

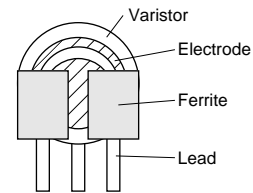

■Surge Absorption Effect of EMIGUARD[®]

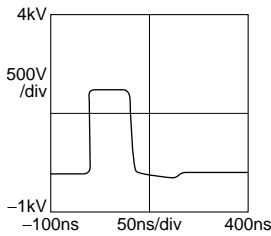
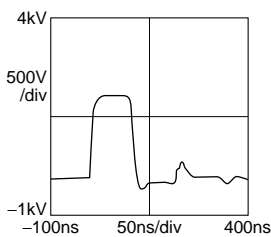
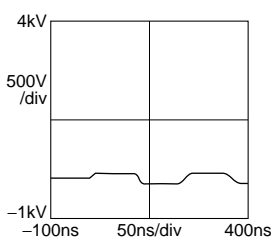
Type of Filter	Surge Absorption Effect of EMIGUARD [®]
No filter	
3-terminal capacitor is used to suppress the surge.	
EMIGUARD [®] is used to suppress the surge. (VFS6V)	

Outline of EMI Suppression Filters (EMIFIL®) for DC Line

● Block Type EMIFIL®

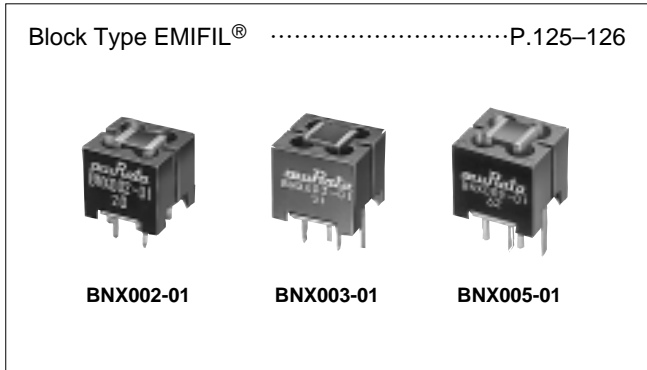

- Block type EMIFIL® are resin encased, built-in, high performance EMI suppression filters, which use a feed-thru capacitor having excellent high frequency characteristics.
- Used when the noise frequency is high, or when extreme countermeasures are required.
- The high performance EMIFIL® BNX series exhibits significant noise suppression effects over a wide frequency band (extending from 100kHz to 1GHz) in DC power lines.

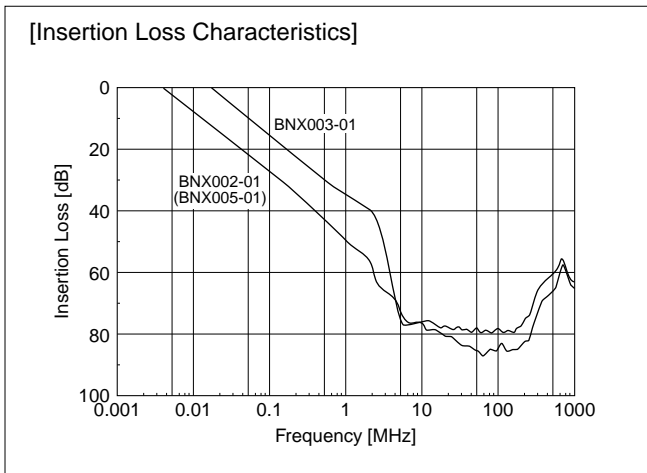
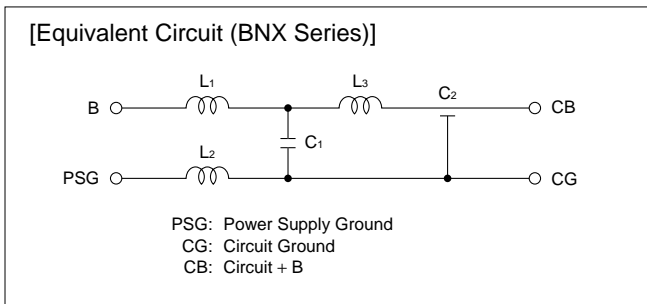

On-Board Type (DC) EMI Suppression Filters (EMIFIL®)



Chip Ferrite Beads Part Numbering

Chip Ferrite Beads

(Global Part Number) **BL M 18 AG 102 S N 1 D**
 1 2 3 4 5 6 7 8 9

① Product ID

Product ID	
BL	Chip Ferrite Beads

② Type

Code	Type
A	Array Type
M	Monolithic Type

③ Dimensions (L×W)

Code	Dimensions (L×W)	EIA
03	0.6×0.3mm	0201
15	1.0×0.5mm	0402
18	1.6×0.8mm	0603
2A	2.0×1.0mm	0804
21	2.0×1.25mm	0805
31	3.2×1.6mm	1206
41	4.5×1.6mm	1806

④ Characteristics/Applications

Code *1	Characteristics/Applications	Series
AF	for General Use	BLM31/BLM41
AG		BLM03/BLM15/BLM18/BLM21/BLM31/BLA2A/BLA31
AJ		BLM21/BLM31
AH		BLM21
BA	for High-speed Signal Lines	BLM18
BB		BLM15/BLM18/BLM21/BLA2A
BD		BLM15/BLM18/BLM21/BLA31
BE		BLM31
PF		BLM41
PG	for Power Supplies	BLM18/BLM21/BLM31/BLM41
RK	for Digital Interface	BLM18/BLM21
HG	for GHz Band General Use	BLM18
EG	for GHz Band General Use (Low DC Resistance type)	
HB	for GHz Band High-speed Signal Line	
HD		
HK	for GHz Band Digital Interface	BLM18

*1 Frequency characteristics vary with each code.

⑤ Packaging

Code	Packaging	Series
K	Plastic Taping (ø330mm Reel)	BLM31/BLM41/BLM21 *1
L	Plastic Taping (ø180mm Reel)	
B	Bulk	All series
J	Paper Taping (ø330mm Reel)	BLM15/BLM18/BLM21 *2 / BLA31
D	Paper Taping (ø180mm Reel)	BLM03/BLM15/BLM18/BLM21 *2 / BLA2A/BLA31
C	Bulk Case	BLM15/BLM18

*1 BLM21BD222SN1/BLM21BD272SN1 only.

*2 Except BLM21BD222SN1/BLM21BD272SN1

⑥ Impedance

Expressed by three figures. The unit is in ohm (Ω). The first and second figures are significant digits, and the third figure expresses the number of zeros which follow the two figures.

⑦ Performance

Expressed by a letter.

Ex.)

Code	Performance
S	Sn Plating

⑧ Category

Code	Category
N	Standard Type
H	for Heavy-duty

⑨ Number of Circuits

Code	Number of Circuits
1	1 Circuit
4	4 Circuits

On-Board Type (DC) EMI Suppression Filters(EMIFIL®)



Chip Ferrite Bead BLM Series

Essential for Noise Suppression in High Speed Signal Lines and DC Power Lines

1

The chip ferrite bead BLM series comprises ferrite beads in the shape of a chip. This ferrite bead generates a high impedance which at high frequencies mainly consists of a resistance element. The BLM series is effective in circuits without stable ground lines because the BLM series does not need a connection to ground.

Chip sizes of 0.6×0.3, 1.0×0.5, 1.6×0.8, 2.0×1.25, 3.2×1.6 and 4.5×1.6mm are cataloged. (The BLA series of array type chip ferrite beads is also cataloged.)

The nickel barrier structure of the external electrodes provides excellent solder heat resistance.

■Features

The BLM series comprises the R series (for digital interface), the A series (for standard), the B series (for high speed signal), the P series (for large current), and the H/E series (for GHz range noise suppression).

1. BLM□□R series – For Digital Interface

The BLM-R series can be used in Digital Interface. Resistance of BLM-R series especially grows in the lower frequency range. Therefore BLM-R series is less effective for digital signal waveform at low frequency range and can suppress the ringing.

2. BLM□□A series – For Standard

The BLM-A series generates an impedance from the relatively low frequencies. Therefore the BLM-A series is effective in noise suppression in the wide frequency range (30MHz – several hundred MHz).

3. BLM□□B series – For High Speed Signal

The BLM-B series can minimize attenuation of the signal waveform due to its sharp impedance characteristics. Various impedances are available to match signal frequency.

4. BLM□□P series – For Large Current

The BLM-P series can be used in high current circuits due to its low DC resistance. It can match power lines to a maximum of 6A DC (BLM41P).

5. BLM18H/E series – For GHz Range Noise Suppression

The BLM18H/E series has a modified internal electrode structure that minimizes stray capacitance and increases the effective frequency range.

[Impedance Characteristics]

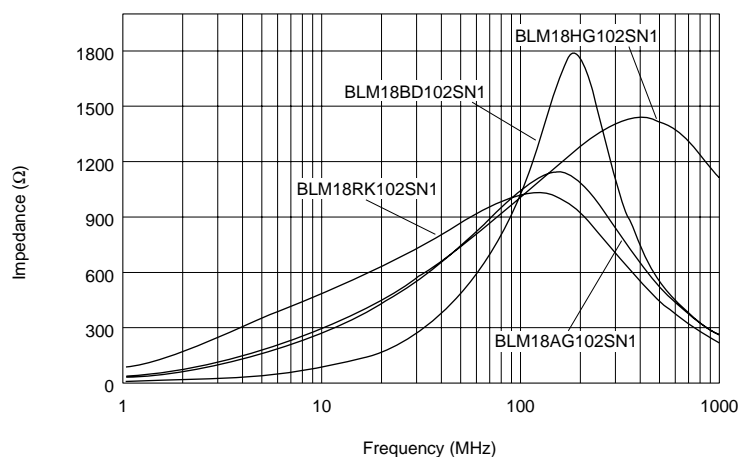

■ Impedance Map

1

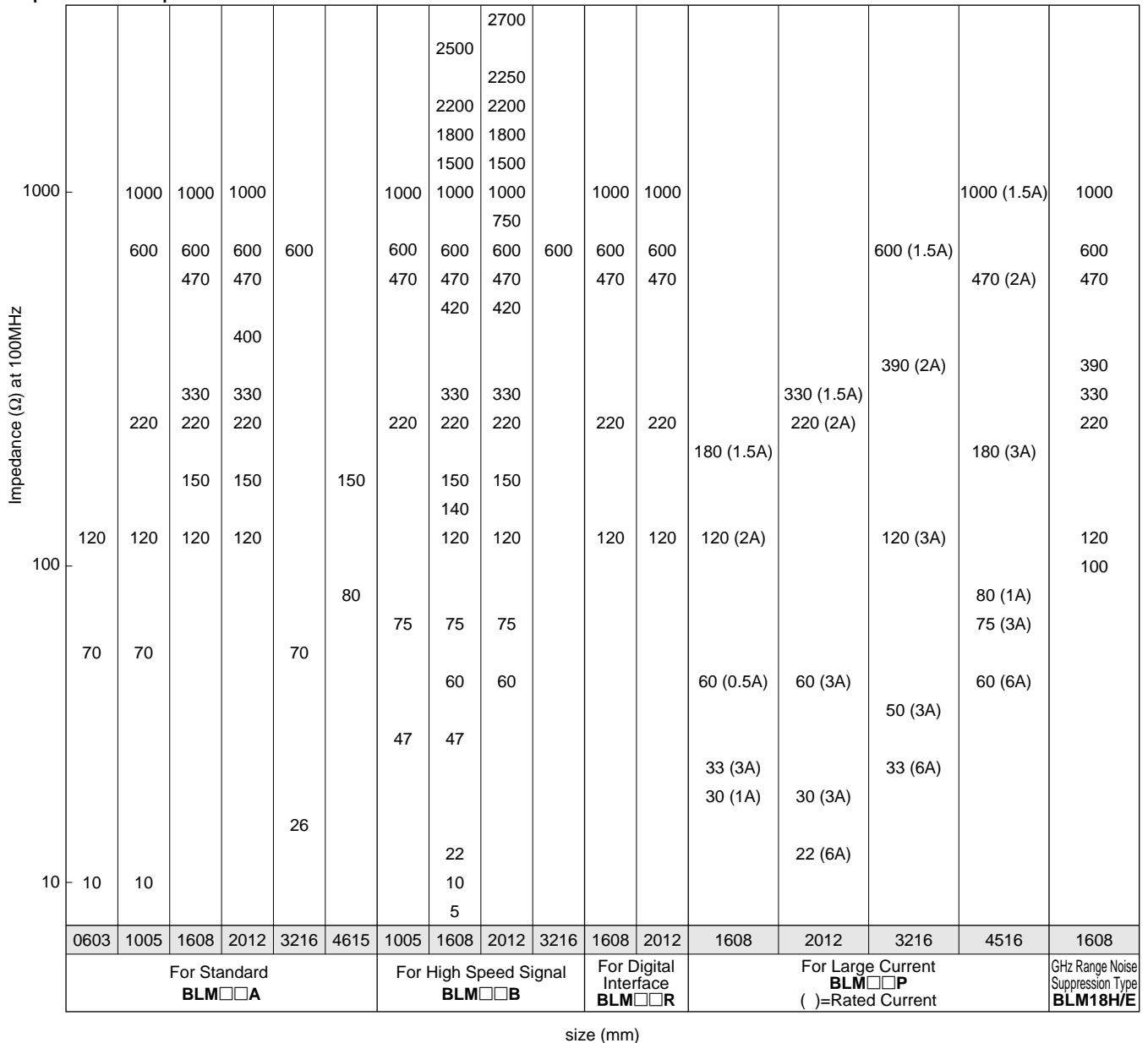

0603 1005 1608 2012 3216 4615 1005 1608 2012 3216 1608 2012 3216 4516 1608

For Standard BLM□□A For High Speed Signal BLM□□B For Digital Interface BLM□□R For Large Current BLM□□P ()=Rated Current GHz Range Noise Suppression Type BLM18H/E

size (mm)

■BLM Series

Size (inches)	Type	Part Number	Impedance (Ω)		Rated Current (mA)
			at 100MHz	at 1GHz	
0603	For Standard	BLM03AG100SN1	10 (Typ.)	-	500
		BLM03AG700SN1	70 (Typ.)	-	200
		BLM03AG121SN1	120±25%	-	200
0402	For Standard	BLM15AG100SN1	10 (Typ.)	-	1000
		BLM15AG700SN1	70 (Typ.)	-	500
		BLM15AG121SN1	120±25%	-	
		BLM15AG221SN1	220±25%	-	300
		BLM15AG601SN1	600±25%	-	
		BLM15AG102SN1	1000±25%	-	200
	For High Speed Signal (Sharp impedance characteristics)	BLM15BB050SN1	5±25%	-	300
		BLM15BB100SN1	10±25%	-	
		BLM15BB220SN1	22±25%	-	
		BLM15BB470SN1	47±25%	-	
		BLM15BB750SN1	75±25%	-	200
		BLM15BB121SN1	120±25%	-	
		BLM15BB221SN1	220±25%	-	
		BLM15BD471SN1	470±25%	-	
		BLM15BD601SN1	600±25%	-	
		BLM15BD102SN1	1000±25%	-	
		0603	For Standard	BLM18AG121SN1	
BLM18AG151SN1	150±25%			-	
BLM18AG221SN1	220±25%			-	
BLM18AG331SN1	330±25%			-	
BLM18AG471SN1	470±25%			-	
BLM18AG601SN1	600±25%			-	
BLM18AG102SN1	1000±25%			-	100
For High Speed Signal (Sharp impedance characteristics)	BLM18BA050SN1		5±25%	-	500
	BLM18BB050SN1			-	700
	BLM18BA100SN1		10±25%	-	500
	BLM18BB100SN1			-	
	BLM18BA220SN1		22±25%	-	300
	BLM18BB220SN1			-	
	BLM18BA470SN1		47±25%	-	500
	BLM18BB470SN1			-	200
	BLM18BB600SN1		60±25%	-	300
	BLM18BA750SN1		75±25%	-	200
	BLM18BB750SN1			-	
	BLM18BA121SN1		120±25%	-	200
	BLM18BB121SN1			-	
	BLM18BD121SN1			-	
	BLM18BB141SN1		140±25%	-	200
	BLM18BB151SN1		150±25%	-	
	BLM18BD151SN1			-	
	BLM18BB221SN1		220±25%	-	
	BLM18BD221SN1			-	
	BLM18BB331SN1		330±25%	-	50
	BLM18BD331SN1			-	
	BLM18BD421SN1		420±25%	-	
	BLM18BB471SN1		470±25%	-	
	BLM18BD471SN1			-	200
	BLM18BD601SN1		600±25%	-	100
BLM18BD102SN1	1000±25%	-	50		
BLM18BD152SN1	1500±25%	-			
BLM18BD182SN1	1800±25%	-			
BLM18BD222SN1	2200±25%	-			
BLM18BD252SN1	2500±25%	-			

Continued on the following page.

Continued from the preceding page.

Size (inches)	Type		Part Number	Impedance (Ω)		Rated Current (mA)		
				at 100MHz	at 1GHz			
0603	For Digital Interface		BLM18RK121SN1	120±25%	-	200		
			BLM18RK221SN1	220±25%	-			
			BLM18RK471SN1	470±25%	-			
			BLM18RK601SN1	600±25%	-			
			BLM18RK102SN1	1000±25%	-			
	For Large Current		BLM18PG300SN1	30 (Typ.)	-	1000		
			BLM18PG330SN1	33±25%	-	3000*		
			BLM18PG600SN1	60 (Typ.)	-	500		
			BLM18PG121SN1	120±25%	-	2000*		
			BLM18PG181SN1	180±25%	-	1500*		
	GHz Range		For Standard	BLM18HG471SN1	470±25%	600 (Typ.)	200	
				BLM18HG601SN1	600±25%	700 (Typ.)		
				BLM18HG102SN1	1000±25%	1000 (Typ.)		
			For High Speed Signal	BLM18HB121SN1	120±25%	500±40%	200	
				BLM18HB221SN1	220±25%	1100±40%	100	
				BLM18HB331SN1	330±25%	1600±40%	50	
				BLM18HD471SN1	470±25%	1000 (Typ.)	100	
				BLM18HD601SN1	600±25%	1200 (Typ.)		
				BLM18HD102SN1	1000±25%	1700 (Typ.)	50	
				For Digital Interface	BLM18HK331SN1	330±25%	400±40%	200
			BLM18HK471SN1		470±25%	600±40%		
			BLM18HK601SN1		600±25%	700±40%	100	
			BLM18HK102SN1		1000±25%	1200±40%	50	
			For Standard (Low DC Resistance Type)		BLM18EG101TN1	100±25%	140 (Typ.)	2000*
					BLM18EG121SN1	120±25%	145 (Typ.)	2000*
					BLM18EG391TN1	390±25%	520 (Typ.)	500
	BLM18EG601SN1	600±25%			700 (Typ.)	300		
	0805	For Standard		BLM21AG121SN1	120±25%	-	200	
BLM21AG151SN1				150±25%	-			
BLM21AG221SN1				220±25%	-			
BLM21AG331SN1				330±25%	-			
BLM21AJ401SN1				400±25%	-			
BLM21AG471SN1				470±25%	-			
BLM21AG601SN1				600±25%	-			
BLM21AJ601SN1					-			
BLM21AG102SN1				1000±25%	-			
BLM21AH102SN1					-			

* Please see P. 51 "Derating of Rated Current".

Continued on the following page. 

Continued from the preceding page.

Size (inches)	Type	Part Number	Impedance (Ω)		Rated Current (mA)
			at 100MHz	at 1GHz	
0805	For High Speed Signal (Sharp impedance characteristics)	BLM21BB050SN1	5±25%	-	500
		BLM21BB600SN1	60±25%	-	200
		BLM21BB750SN1	75±25%	-	
		BLM21BB121SN1	120±25%	-	
		BLM21BD121SN1		-	
		BLM21BB151SN1	150±25%	-	
		BLM21BD151SN1		-	
		BLM21BB201SN1	200±25%	-	
		BLM21BB221SN1	220±25%	-	
		BLM21BD221SN1		-	
		BLM21BB331SN1	330±25%	-	
		BLM21BD331SN1		-	
		BLM21BD421SN1	420±25%	-	
		BLM21BB471SN1	470±25%	-	
		BLM21BD471SN1		-	
		BLM21BD601SN1	600±25%	-	
		BLM21BD751SN1	750±25%	-	
		BLM21BD102SN1	1000±25%	-	
		BLM21BD152SN1	1500±25%	-	
		BLM21BD182SN1	1800±25%	-	
	BLM21BD222SN1	2250 (Typ.)	-		
	BLM21BD222TN1	2200±25%	-		
	BLM21BD272SN1	2700±25%	-		
For Digital Interface	BLM21RK121SN1	120±25%	-	200	
	BLM21RK221SN1	220±25%	-		
	BLM21RK471SN1	470±25%	-		
	BLM21RK601SN1	600±25%	-		
	BLM21RK102SN1	1000±25%	-		
For Large Current	BLM21PG220SN1	22±25%	-	6000*	
	BLM21PG300SN1	30 (Typ.)	-	3000*	
	BLM21PG600SN1	60±25%	-	2000*	
	BLM21PG221SN1	220±25%	-	1500*	
	BLM21PG331SN1	330±25%	-		
1206	For Standard	BLM31AJ260SN1	26±25%	-	500
		BLM31AF700SN1	70±25%	-	200
		BLM31AJ601SN1	600±25%	-	
	For High Speed Signal (Sharp impedance characteristics)	BLM31BE601FN1	600±25%	-	300
	For Large Current	BLM31PG330SN1	33±25%	-	6000*
		BLM31PG500SN1	50 (Typ.)	-	3000*
BLM31PG121SN1		120±25%	-		
BLM31PG391SN1		390±25%	-	2000*	
BLM31PG601SN1	600±25%	-	1500*		
1806	For Standard	BLM41AF800SN1	80±25%	-	500
		BLM41AF151SN1	150±25%	-	200
	For Large Current	BLM41PG600SN1	60 (Typ.)	-	6000*
		BLM41PG750SN1	75 (Typ.)	-	3000*
		BLM41PF800SN1	80 (Typ.)	-	1000*
		BLM41PG181SN1	180±25%	-	3000*
		BLM41PG471SN1	470±25%	-	2000*
BLM41PG102SN1	1000±25%	-	1500*		

* Please see P.51 "Derating of Rated Current".

On-Board Type (DC) EMI Suppression Filters (EMIFIL®)



Chip Ferrite Beads BLM03/BLM15/BLM18/BLM21/BLM31/BLM41 Series

1

■ Features (BLM_A Series)

The chip ferrite bead BLM series comprises ferrite beads in the shape of a chip. This ferrite bead generates a high impedance which at high frequency mainly consists of a resistance element. The BLM series is effective in circuits without stable ground lines because the BLM series does not need a connection to ground.

The nickel barrier structure of the external electrodes provides excellent solder heat resistance. BLM_A series generates an impedance from the relatively low frequencies. Therefore BLM_A series is effective in noise suppression in a wide frequency range (30MHz - several hundred MHz).

The small size of BLM03 series (0.6x0.3mm) is suitable for noise suppression in small equipment such as PA modules for cellular phones.

■ Equivalent Circuit

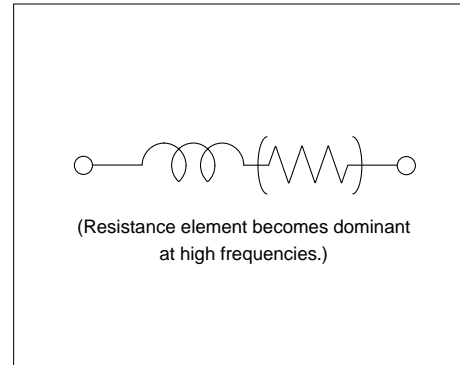

BLM03A Series (0201 Size)

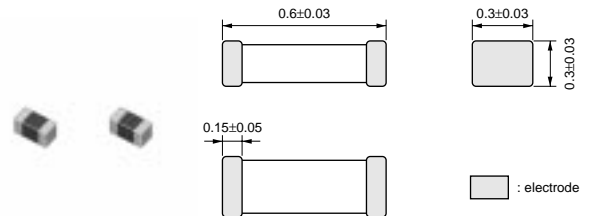

(in mm)

Part Number	Impedance (at 100MHz, 20 degree C) (ohm)	Rated Current (mA)	DC Resistance (max.) (ohm)	Operating Temperature Range (°C)
BLM03AG100SN1	10 (Typ.)	500	0.1	-55 to 125
BLM03AG700SN1	70 (Typ.)	200	0.5	-55 to 125
BLM03AG121SN1	120 ±25%	200	0.8	-55 to 125

Impedance-Frequency (Typical)

BLM03 Series

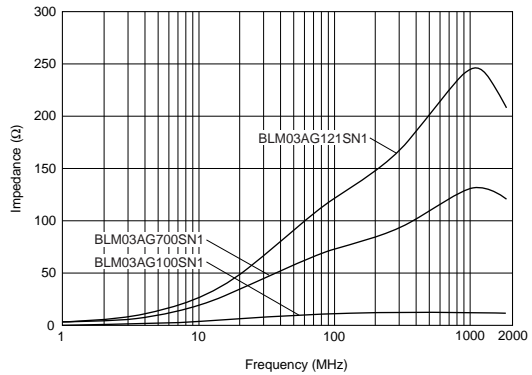

Impedance-Frequency Characteristics

BLM03AG100SN1

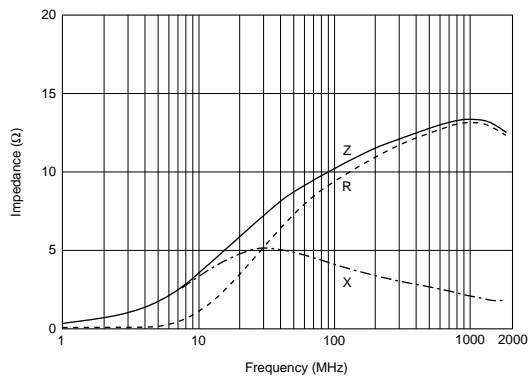

BLM03AG700SN1

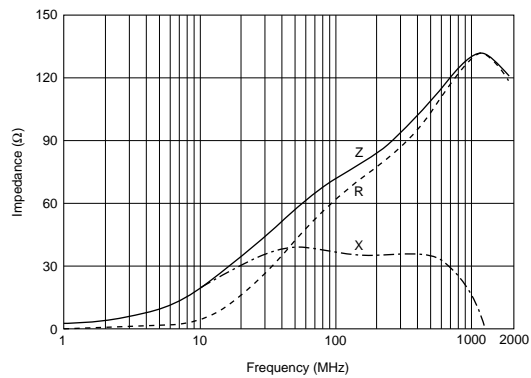

BLM03AG121SN1

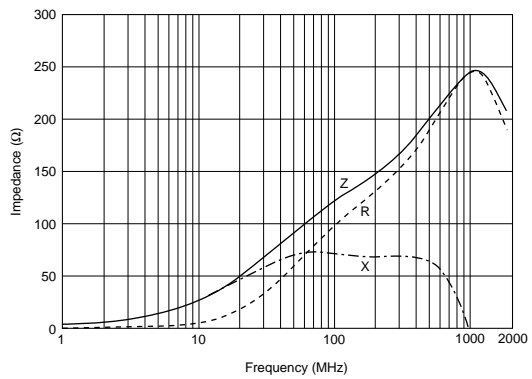

BLM15A Series (0402 Size)

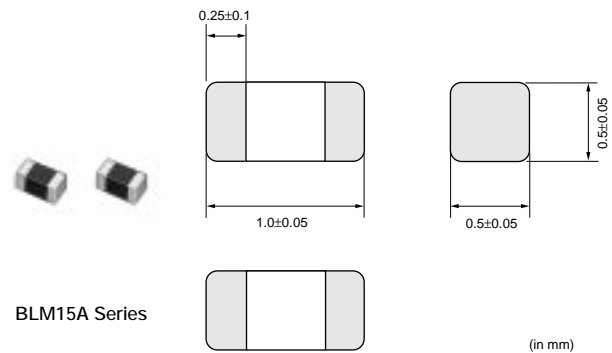

1

Part Number	Impedance (at 100MHz, 20 degree C) (ohm)	Rated Current (mA)	DC Resistance (max.) (ohm)	Operating Temperature Range (°C)
BLM15AG100SN1	10 (Typ.)	1000	0.05	-55 to 125
BLM15AG700SN1	70 (Typ.)	500	0.15	-55 to 125
BLM15AG121SN1	120 ±25%	500	0.25	-55 to 125
BLM15AG221SN1	220 ±25%	300	0.35	-55 to 125
BLM15AG601SN1	600 ±25%	300	0.6	-55 to 125
BLM15AG102SN1	1000 ±25%	200	1.0	-55 to 125

■ Impedance-Frequency (Typical)

BLM15A Series

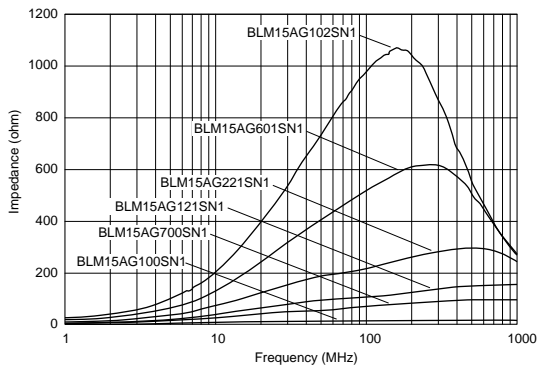

■ Impedance-Frequency Characteristics

BLM15AG100SN1

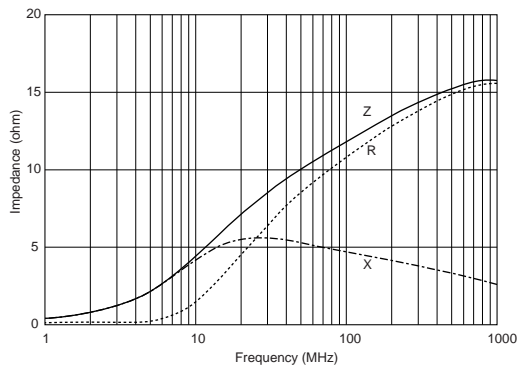

BLM15AG700SN1

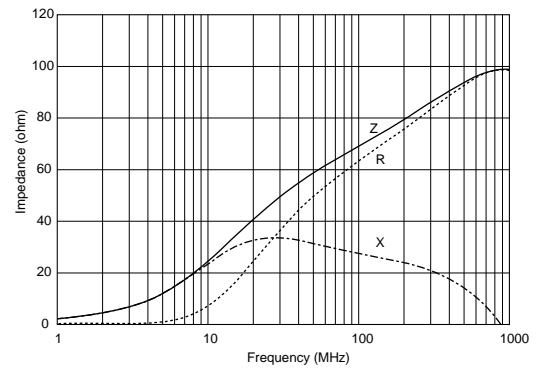

BLM15AG121SN1

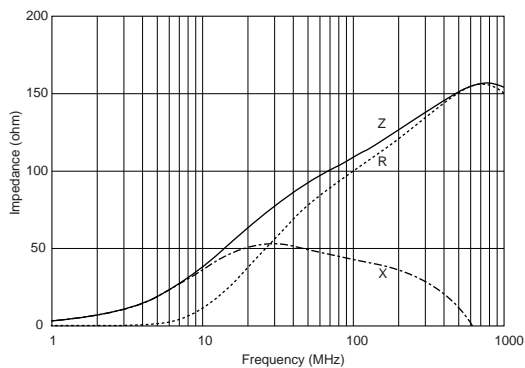

BLM15AG221SN1

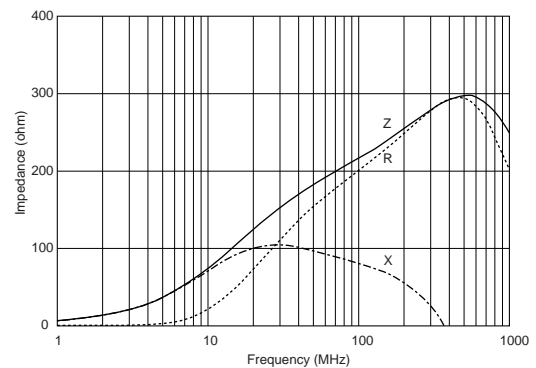

Continued on the following page. ↗

Continued from the preceding page.

Impedance-Frequency Characteristics

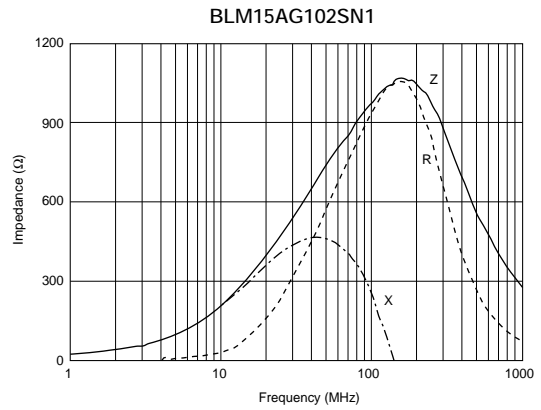
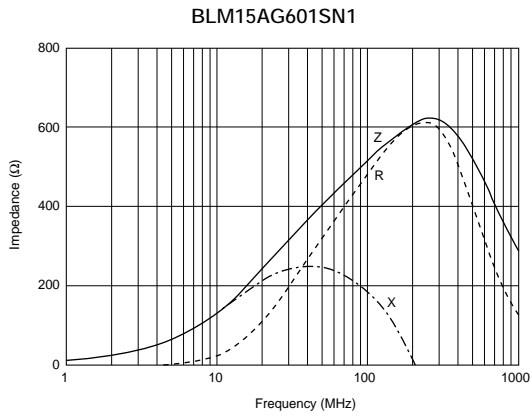

BLM18A Series (0603 Size)

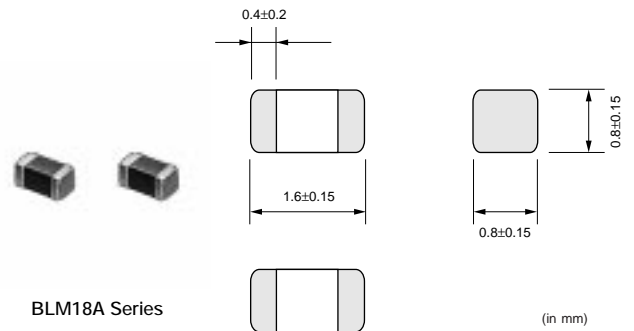

Part Number	Impedance (at 100MHz, 20 degree C) (ohm)	Rated Current (mA)	DC Resistance (max.) (ohm)	Operating Temperature Range (°C)
BLM18AG121SN1	120 ±25%	200	0.20	-55 to 125
BLM18AG151SN1	150 ±25%	200	0.25	-55 to 125
BLM18AG221SN1	220 ±25%	200	0.30	-55 to 125
BLM18AG331SN1	330 ±25%	200	0.45	-55 to 125
BLM18AG471SN1	470 ±25%	200	0.50	-55 to 125
BLM18AG601SN1	600 ±25%	200	0.50	-55 to 125
BLM18AG102SN1	1000 ±25%	100	0.70	-55 to 125

Impedance-Frequency (Typical)

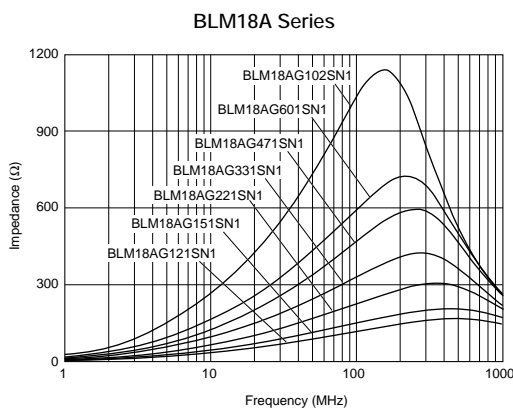

■ Impedance-Frequency Characteristics

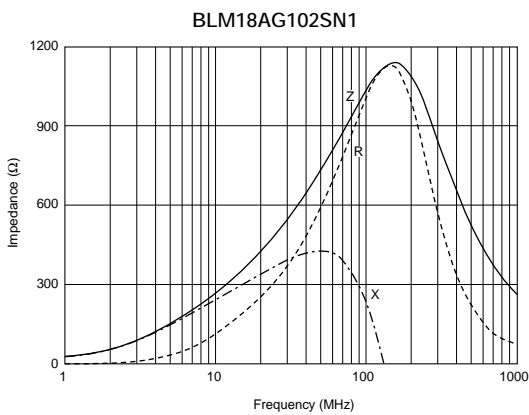
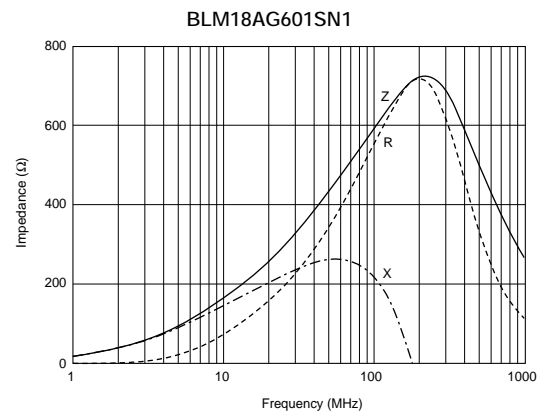
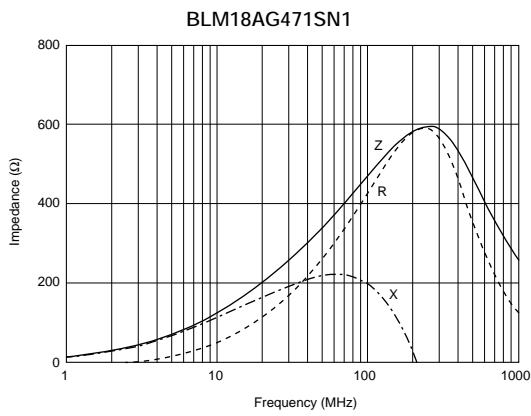
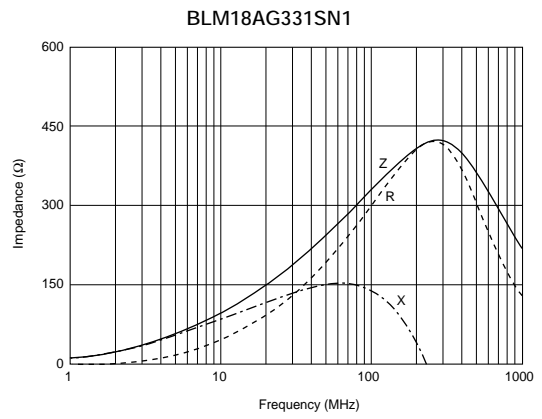
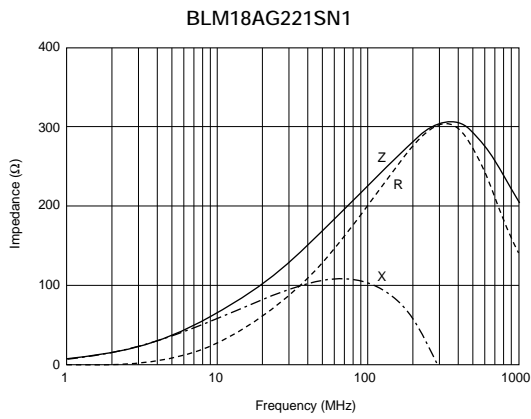
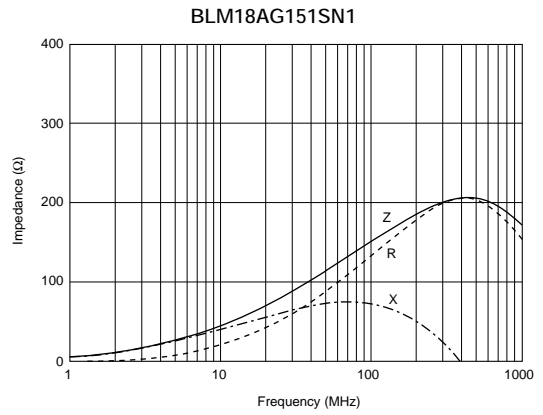
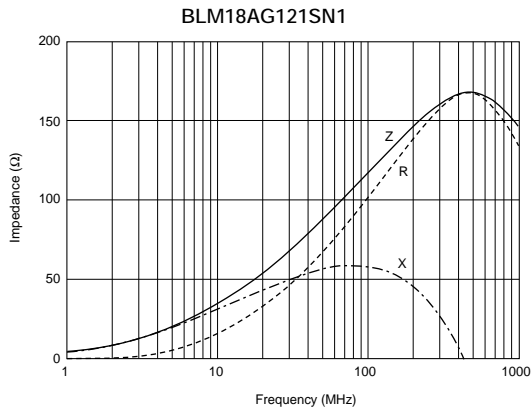

1

BLM21A Series (0805 Size)

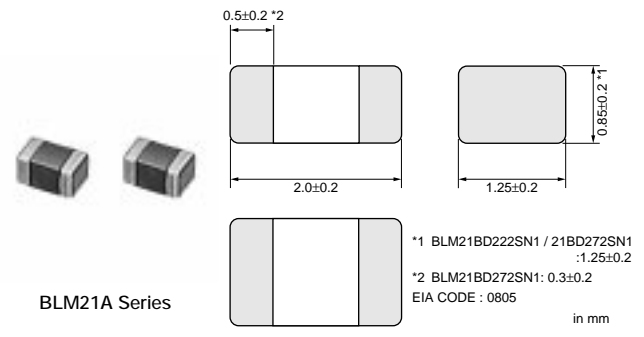

1

Part Number	Impedance (at 100MHz, 20 degree C) (ohm)	Rated Current (mA)	DC Resistance (max.) (ohm)	Operating Temperature Range (°C)
BLM21AG121SN1	120 ±25%	200	0.15	-55 to 125
BLM21AG151SN1	150 ±25%	200	0.15	-55 to 125
BLM21AG221SN1	220 ±25%	200	0.20	-55 to 125
BLM21AG331SN1	330 ±25%	200	0.25	-55 to 125
BLM21AJ401SN1	400 ±25%	200	0.85	-55 to 125
BLM21AG471SN1	470 ±25%	200	0.25	-55 to 125
BLM21AG601SN1	600 ±25%	200	0.30	-55 to 125
BLM21AJ601SN1	600 ±25%	200	1.10	-55 to 125
BLM21AG102SN1	1000 ±25%	200	0.45	-55 to 125
BLM21AH102SN1	1000 ±25%	200	0.45	-55 to 85

■ Impedance-Frequency (Typical)

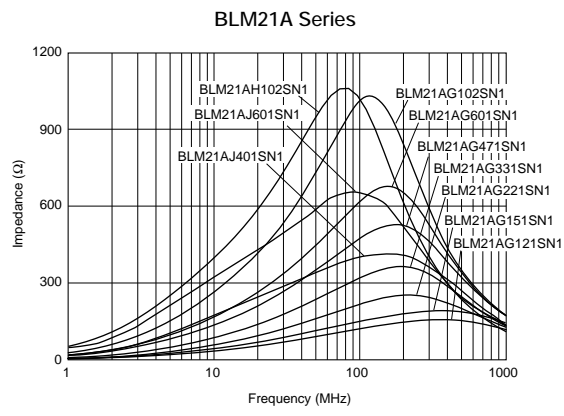

■ Impedance-Frequency Characteristics

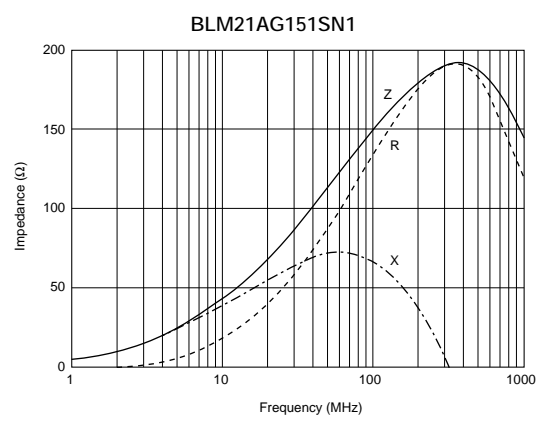
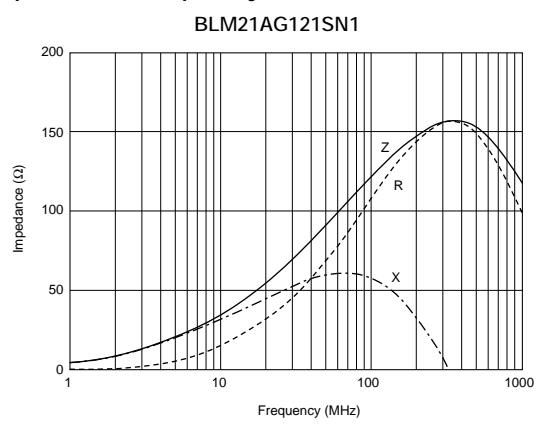

Continued on the following page. ↗

Continued from the preceding page.

Impedance-Frequency Characteristics

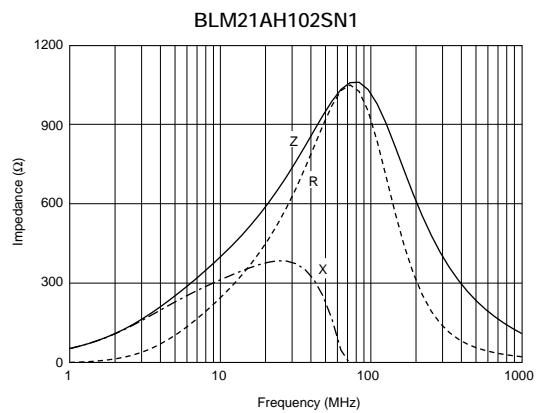
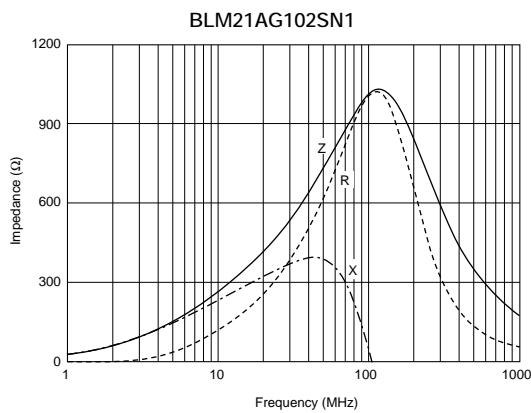
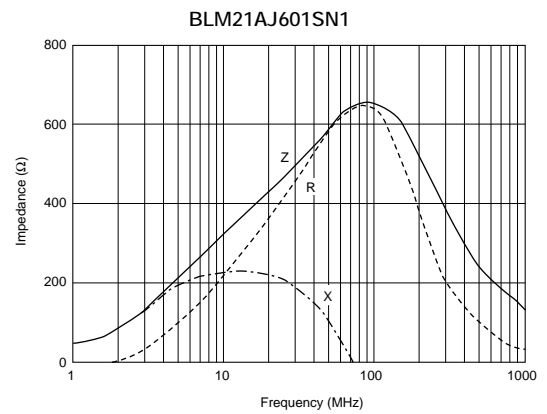
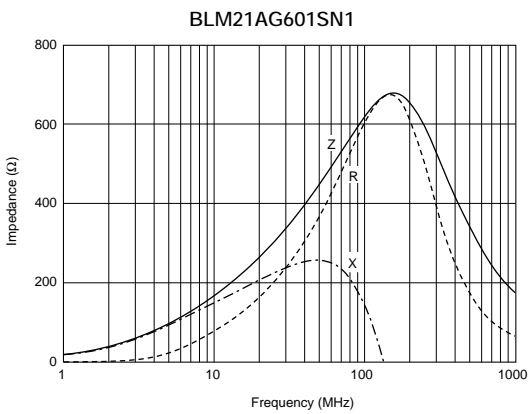
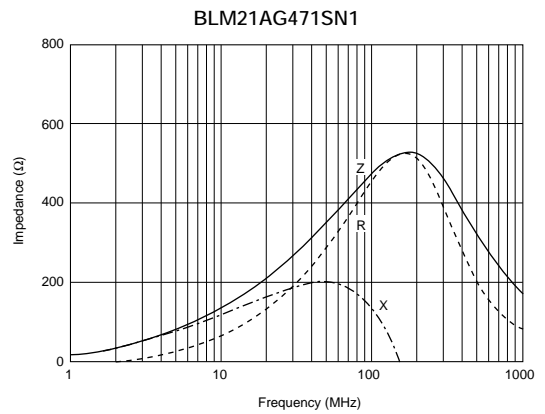
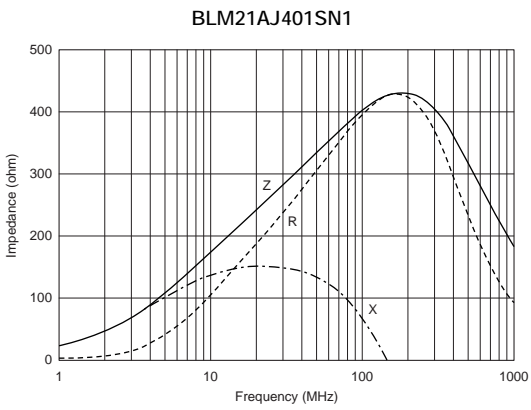
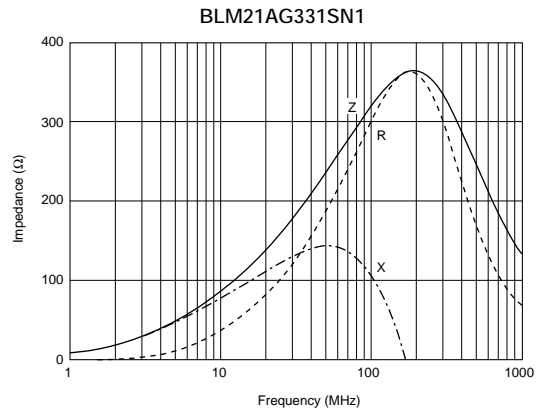
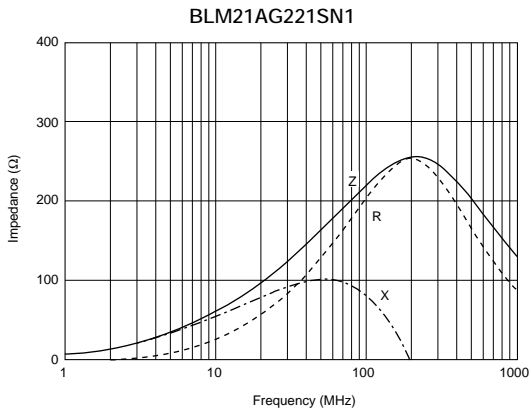

1

BLM31A Series (1206 Size)

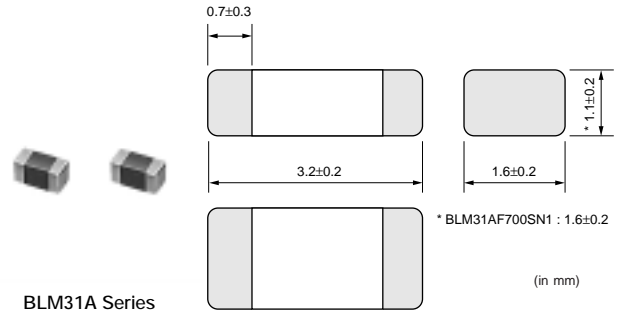

1

Part Number	Impedance (at 100MHz, 20 degree C) (ohm)	Rated Current (mA)	DC Resistance (max.) (ohm)	Operating Temperature Range (°C)
BLM31AJ260SN1	26 ±25%	500	0.05	-55 to 125
BLM31AF700SN1	70 ±25%	200	0.15	-55 to 125
BLM31AJ601SN1	600 ±25%	200	0.90	-55 to 125

■ Impedance-Frequency (Typical)

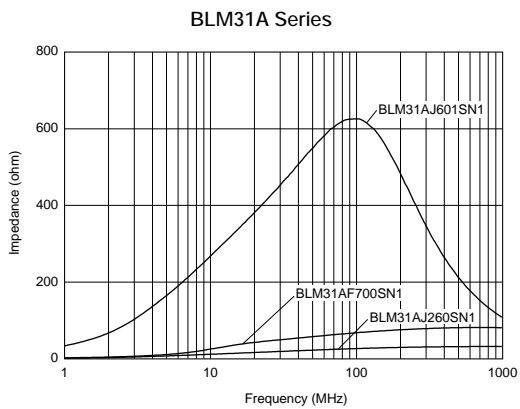

■ Impedance-Frequency Characteristics

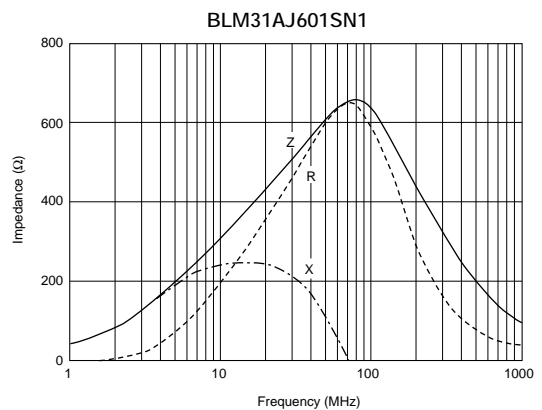
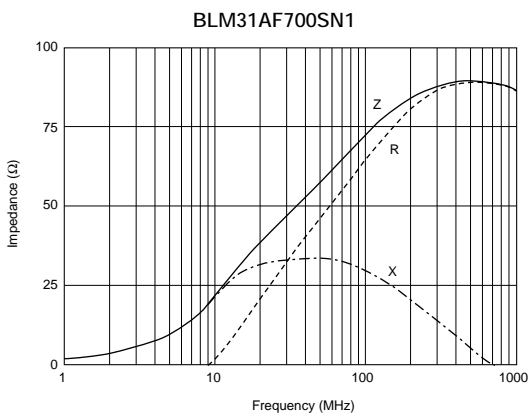
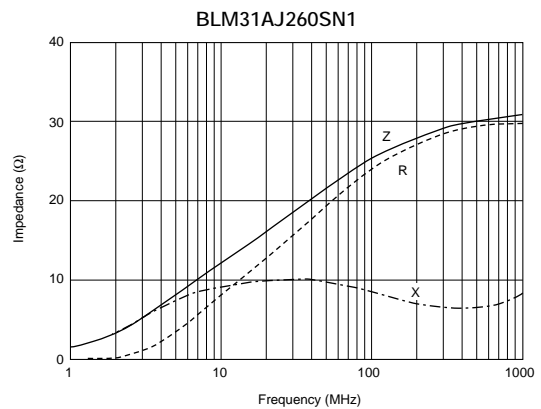

BLM41A Series (1806 Size)

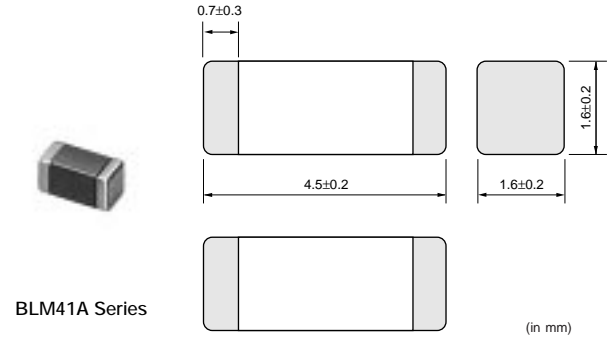

Part Number	Impedance (at 100MHz, 20 degree C) (ohm)	Rated Current (mA)	DC Resistance (max.) (ohm)	Operating Temperature Range (°C)
BLM41AF800SN1	80 ±25%	500	0.10	-55 to 125
BLM41AF151SN1	150 ±25%	200	0.50	-55 to 125

■ Impedance-Frequency (Typical)

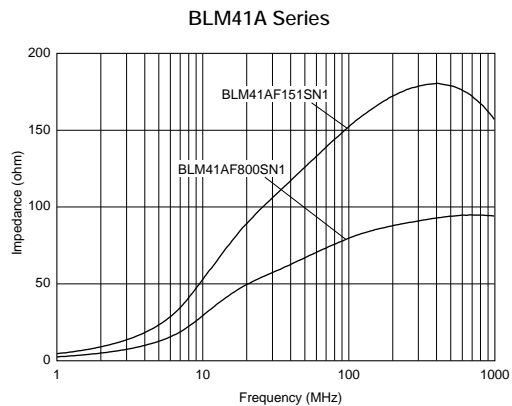

■ Impedance-Frequency Characteristics

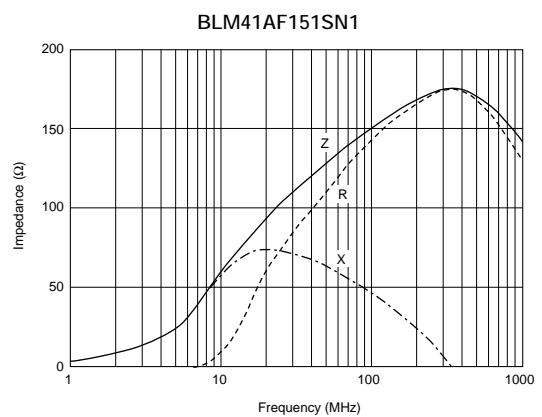
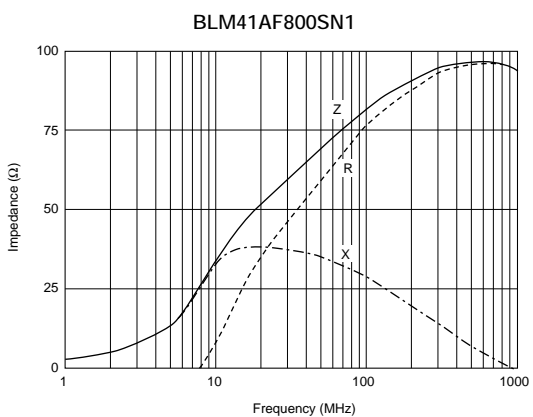

■ Features (BLM_B Series)

The chip ferrite bead BLM series comprises ferrite beads in the shape of a chip. This ferrite bead generates a high impedance which at high frequencies mainly consists of a resistance element. The BLM series is effective in circuits without stable ground lines because the BLM series does not need a connection to ground.

The nickel barrier structure of the external electrodes provides excellent solder heat resistance. The BLM_B series can minimize attenuation of the signal waveform due to its sharp impedance characteristics. Various impedances are available to match signal frequency.

■ Equivalent Circuit

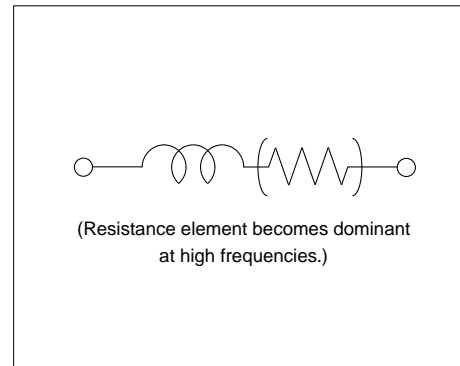

BLM15B Series (0402 Size)

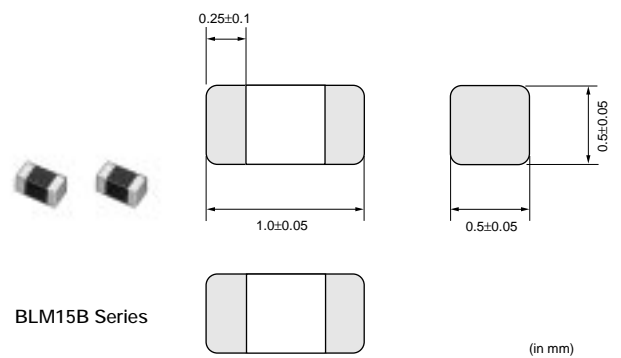

Part Number	Impedance (at 100MHz, 20 degree C) (ohm)	Rated Current (mA)	DC Resistance (max.) (ohm)	Operating Temperature Range (°C)
BLM15BB050SN1	5 ±25%	500	0.08	-55 to 125
BLM15BB100SN1	10 ±25%	300	0.10	-55 to 125
BLM15BB220SN1	22 ±25%	300	0.20	-55 to 125
BLM15BB470SN1	47 ±25%	300	0.35	-55 to 125
BLM15BB750SN1	75 ±25%	300	0.40	-55 to 125
BLM15BB121SN1	120 ±25%	300	0.55	-55 to 125
BLM15BB221SN1	220 ±25%	200	0.80	-55 to 125
BLM15BD471SN1	470 ±25%	200	0.60	-55 to 125
BLM15BD601SN1	600 ±25%	200	0.65	-55 to 125
BLM15BD102SN1	1000 ±25%	200	0.90	-55 to 125

Rated current is 6A for taping type.

■ Impedance-Frequency (Typical)

BLM15BB Series

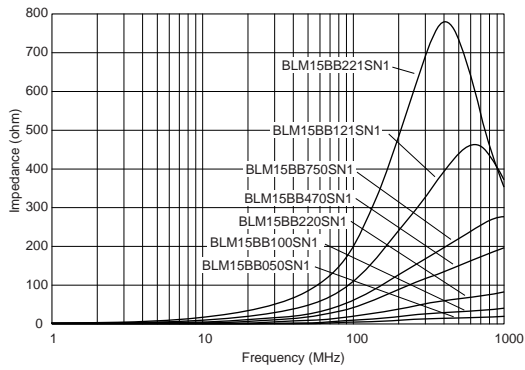

BLM15BD Series

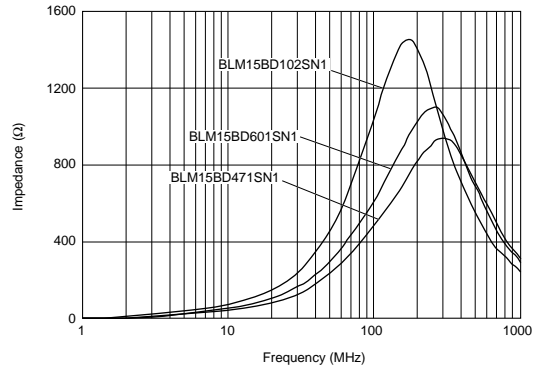

■ Impedance-Frequency Characteristics

BLM15BB050SN1

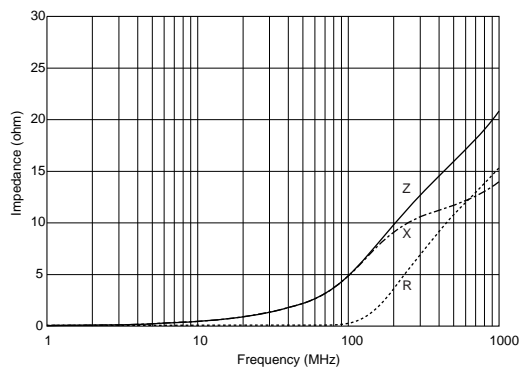

BLM15BB100SN1

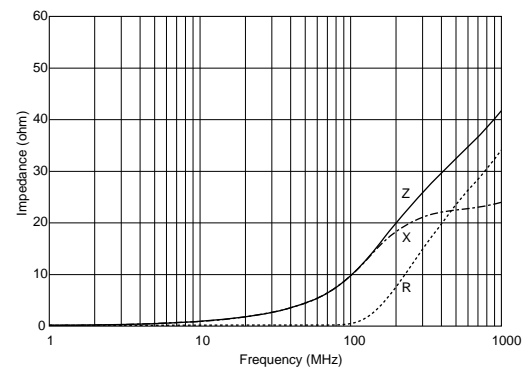

BLM15BB220SN1

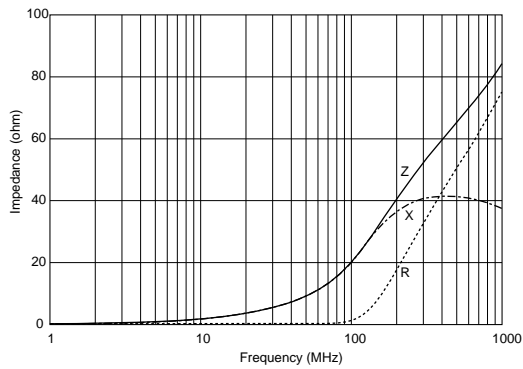

BLM15BB470SN1

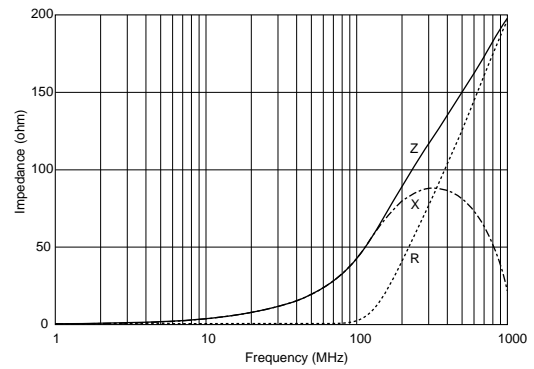

BLM15BB750SN1

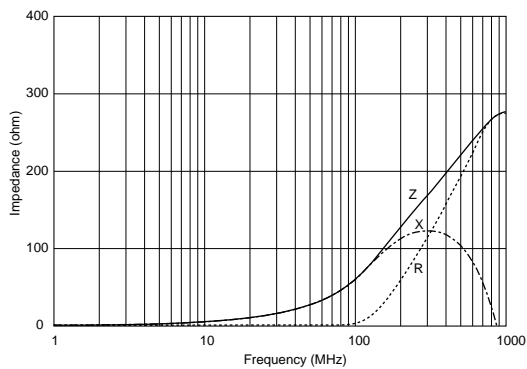

BLM15BB121SN1

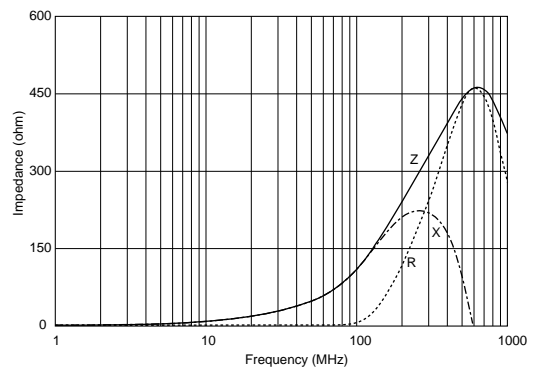

Continued on the following page. ↗

Continued from the preceding page.

Impedance-Frequency Characteristics

BLM15BB221SN1

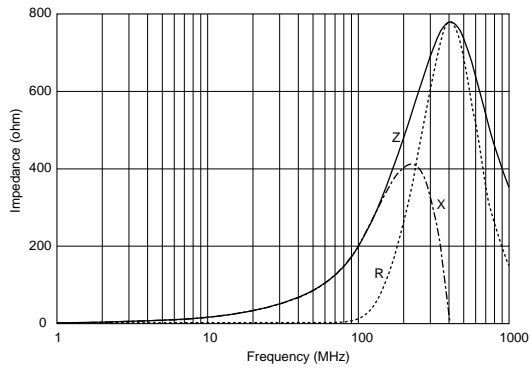

BLM15BD471SN1

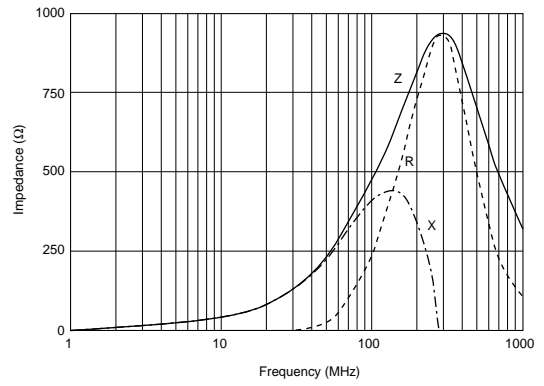

BLM15BD601SN1

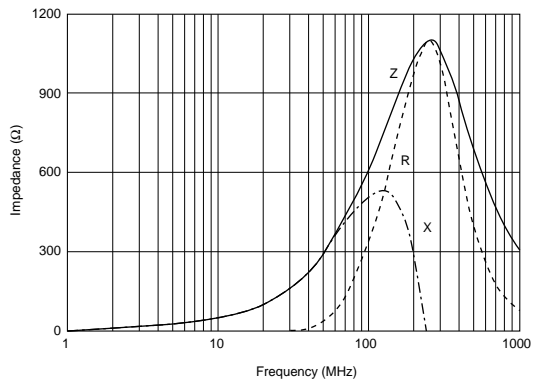

BLM15BD102SN1

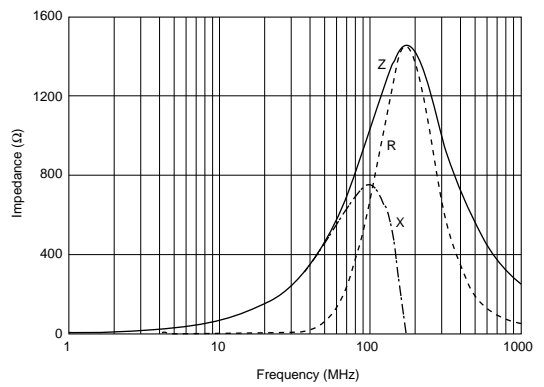

1

BLM18B Series (0603 Size)

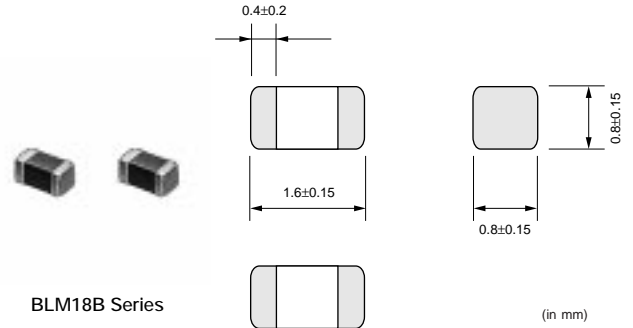

Part Number	Impedance (at 100MHz, 20 degree C) (ohm)	Rated Current (mA)	DC Resistance (max.) (ohm)	Operating Temperature Range (°C)
BLM18BA050SN1	5 ±25%	500	0.20	-55 to 125
BLM18BB050SN1	5 ±25%	700	0.10	-55 to 125
BLM18BA100SN1	10 ±25%	500	0.25	-55 to 125
BLM18BB100SN1	10 ±25%	500	0.15	-55 to 125
BLM18BA220SN1	22 ±25%	500	0.35	-55 to 125
BLM18BB220SN1	22 ±25%	500	0.25	-55 to 125
BLM18BA470SN1	47 ±25%	300	0.55	-55 to 125
BLM18BB470SN1	47 ±25%	500	0.30	-55 to 125
BLM18BB600SN1	60 ±25%	200	0.35	-55 to 125
BLM18BA750SN1	75 ±25%	300	0.70	-55 to 125
BLM18BB750SN1	75 ±25%	200	0.35	-55 to 125
BLM18BA121SN1	120 ±25%	200	0.90	-55 to 125
BLM18BB121SN1	120 ±25%	200	0.50	-55 to 125
BLM18BD121SN1	120 ±25%	200	0.40	-55 to 125
BLM18BB141SN1	140 ±25%	200	0.55	-55 to 125
BLM18BB151SN1	150 ±25%	200	0.55	-55 to 125
BLM18BD151SN1	150 ±25%	200	0.40	-55 to 125
BLM18BB221SN1	220 ±25%	200	0.65	-55 to 125
BLM18BD221SN1	220 ±25%	200	0.45	-55 to 125
BLM18BB331SN1	330 ±25%	200	0.75	-55 to 125
BLM18BD331SN1	330 ±25%	200	0.50	-55 to 125
BLM18BD421SN1	420 ±25%	200	0.55	-55 to 125
BLM18BB471SN1	470 ±25%	50	1.00	-55 to 125
BLM18BD471SN1	470 ±25%	200	0.55	-55 to 125
BLM18BD601SN1	600 ±25%	200	0.65	-55 to 125
BLM18BD102SN1	1000 ±25%	100	0.85	-55 to 125
BLM18BD152SN1	1500 ±25%	50	1.20	-55 to 125
BLM18BD182SN1	1800 ±25%	50	1.50	-55 to 125
BLM18BD222SN1	2200 ±25%	50	1.50	-55 to 125
BLM18BD252SN1	2500 ±25%	50	1.50	-55 to 125

■ Impedance-Frequency (Typical)

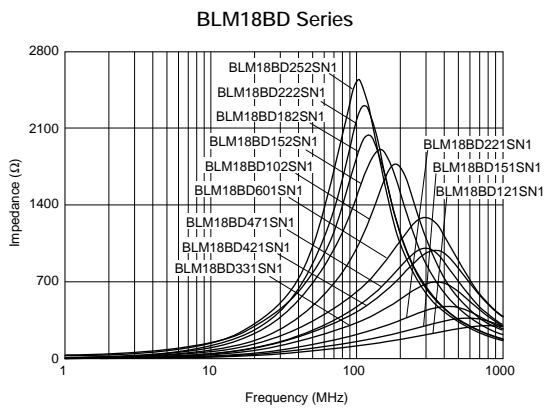
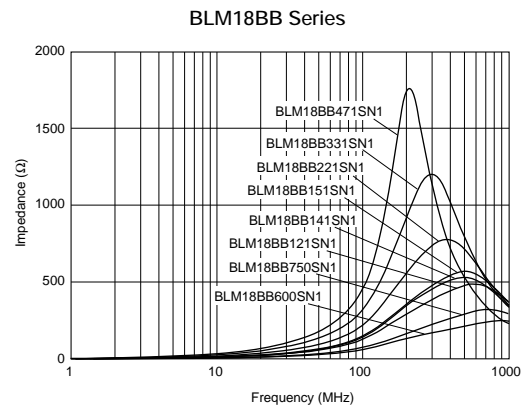
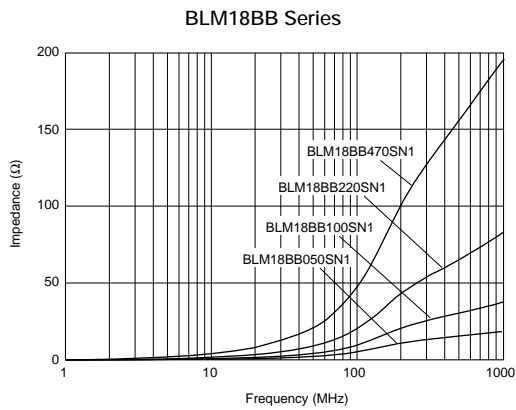
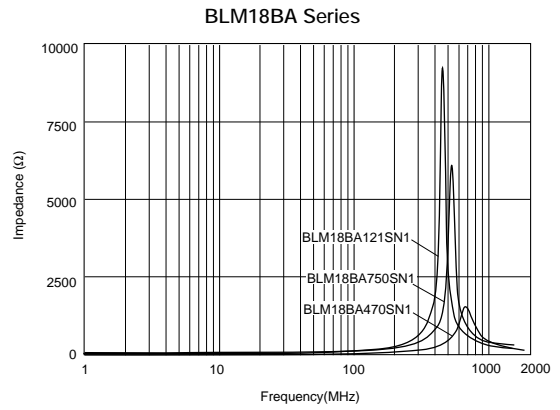
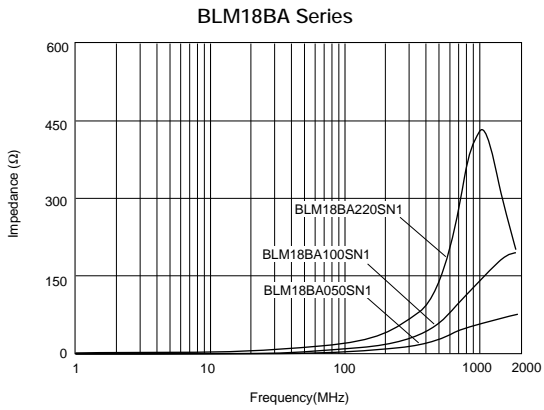

■ Impedance-Frequency Characteristics

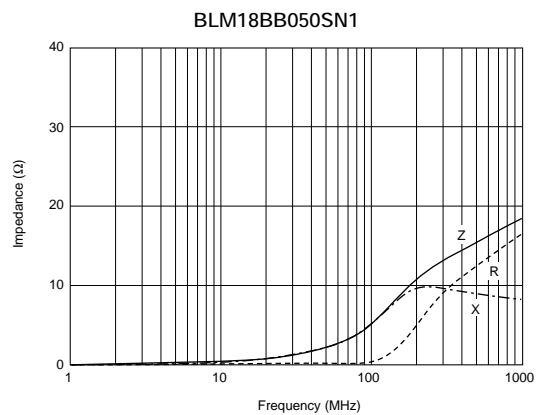
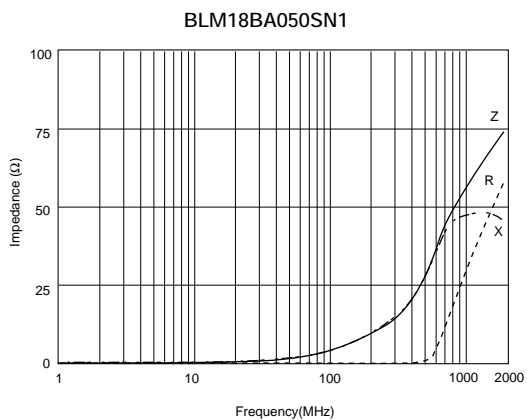

Continued on the following page. ↗

Continued from the preceding page.

■ Impedance-Frequency Characteristics

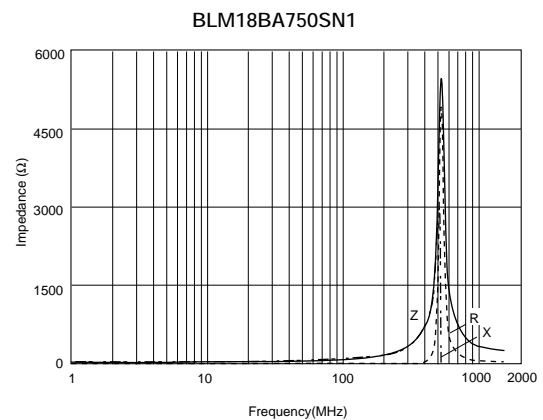
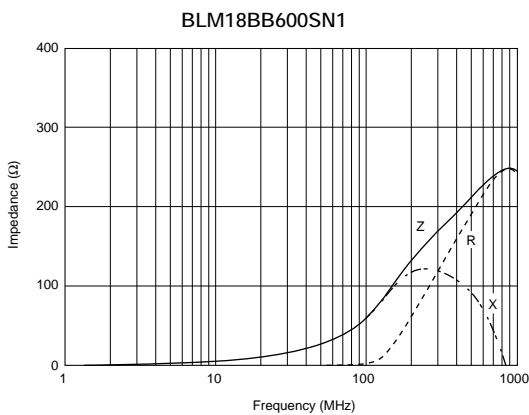
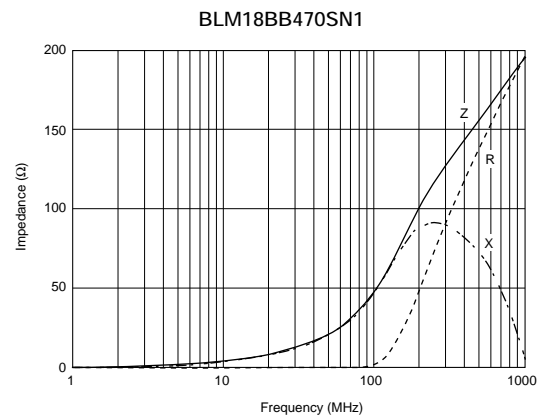
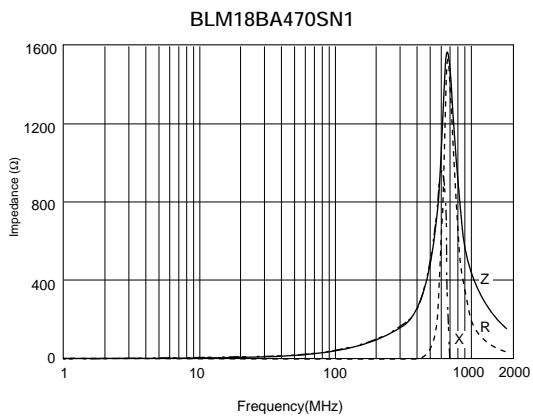
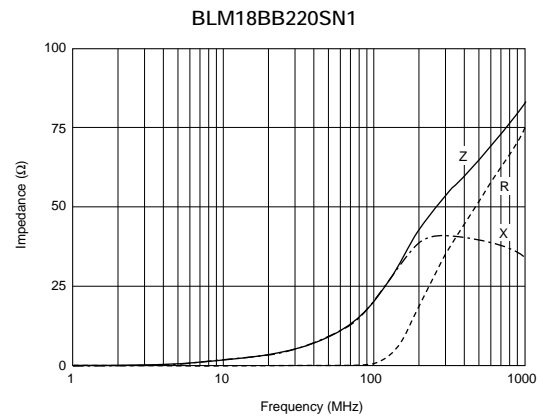
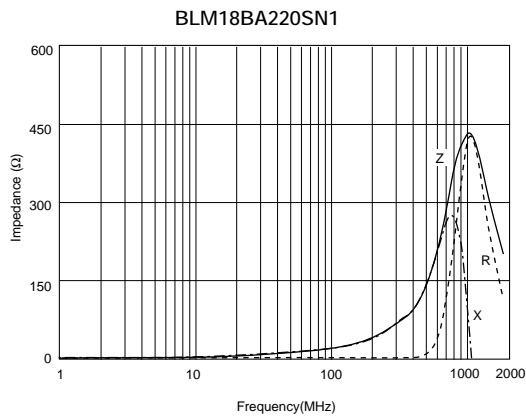
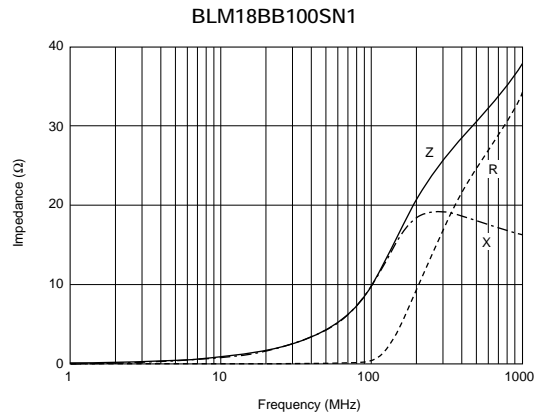
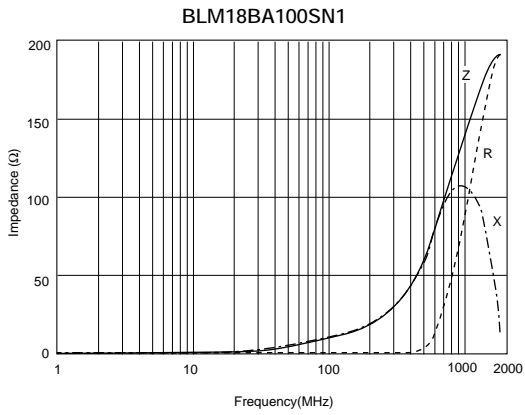

1

↳ Continued from the preceding page.

■ Impedance-Frequency Characteristics

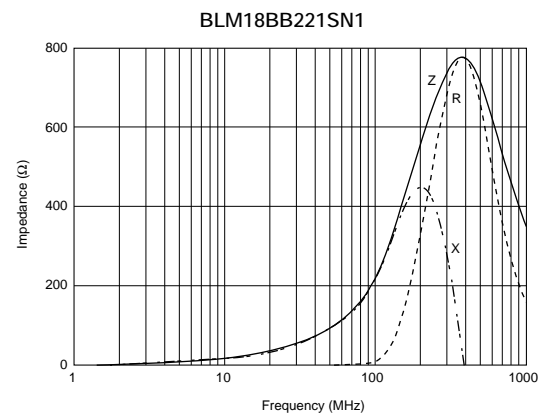
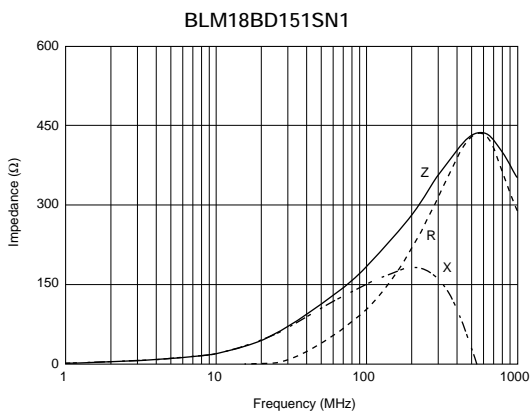
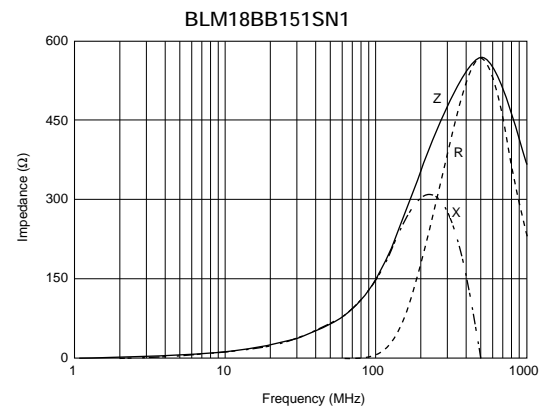
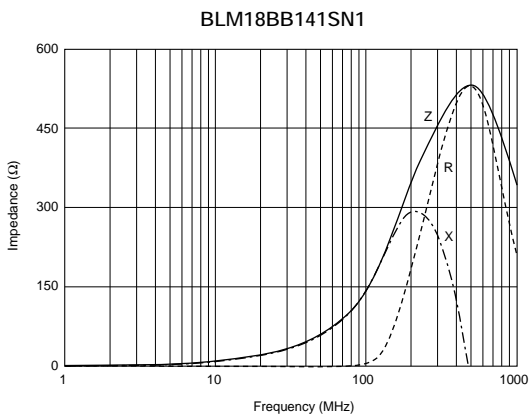
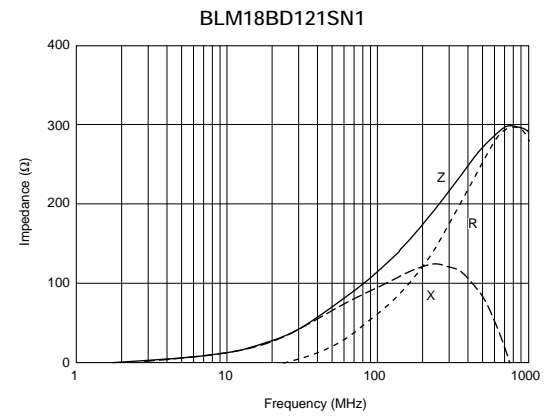
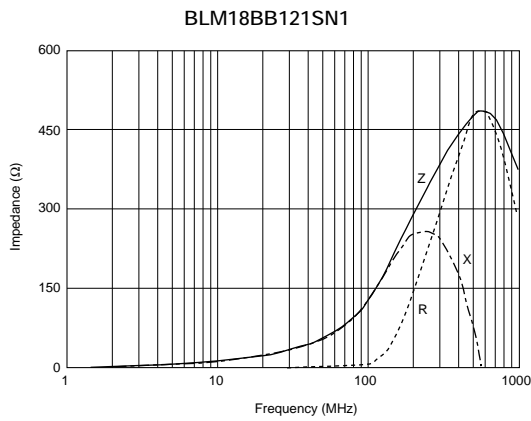
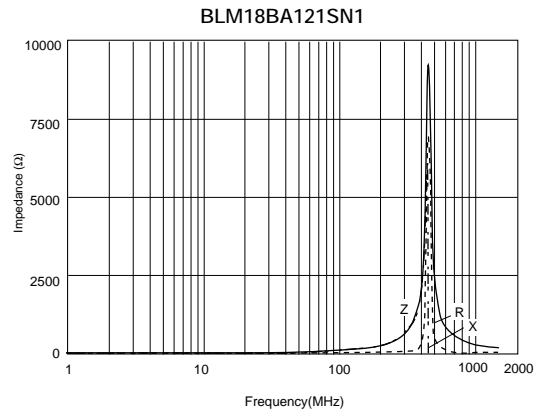
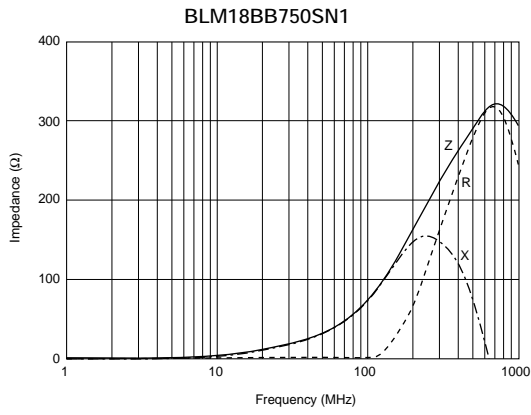

Continued on the following page. ↗

Continued from the preceding page.

Impedance-Frequency Characteristics

BLM18BD221SN1

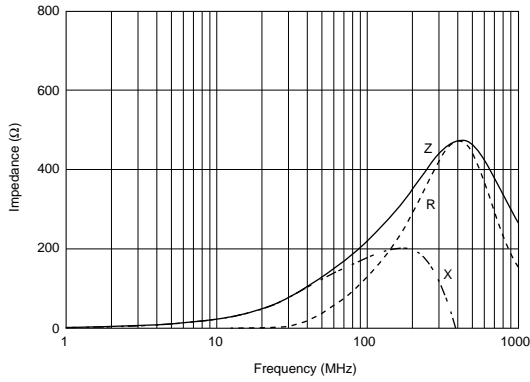

BLM18BB331SN1

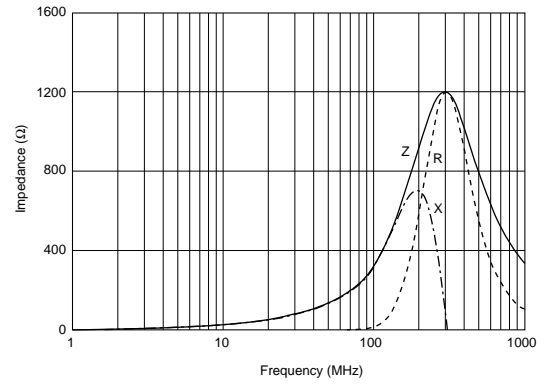

BLM18BD331SN1

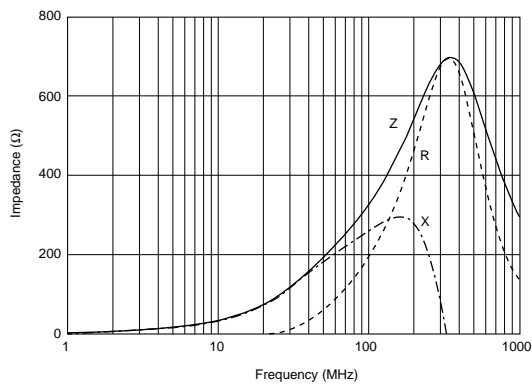

BLM18BD421SN1

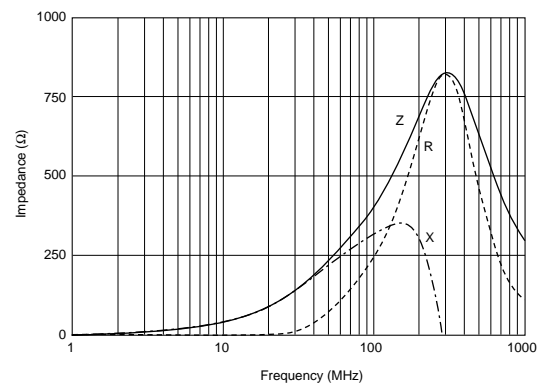

BLM18BB471SN1

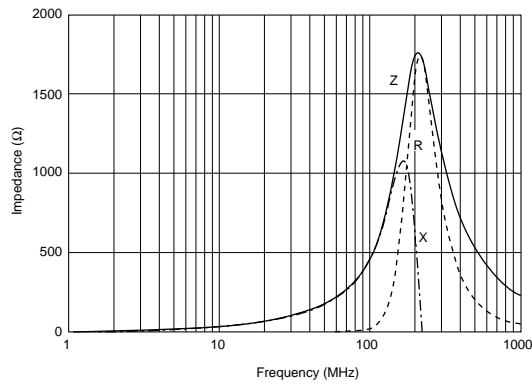

BLM18BD471SN1

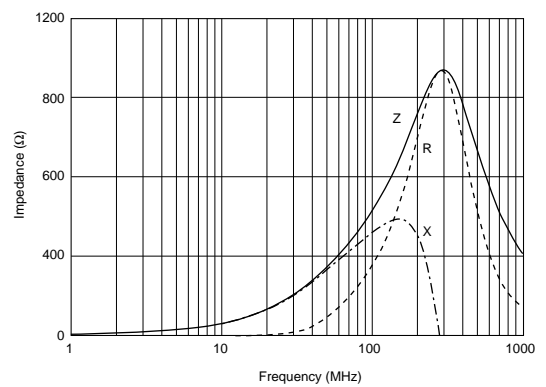

BLM18BD601SN1

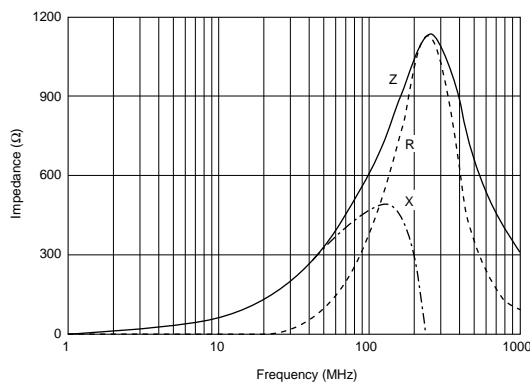

BLM18BD102SN1

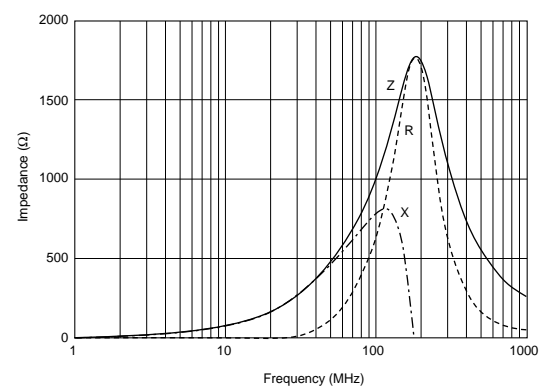

1

↳ Continued from the preceding page.

■ Impedance-Frequency Characteristics

BLM18BD152SN1

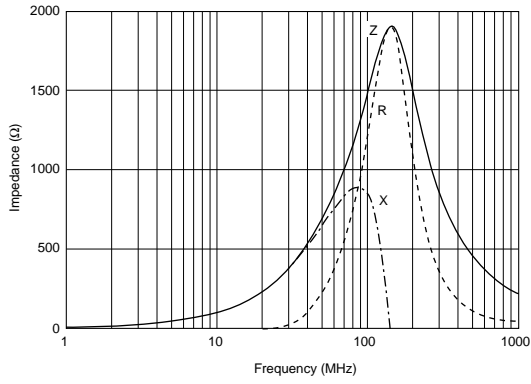

BLM18BD182SN1

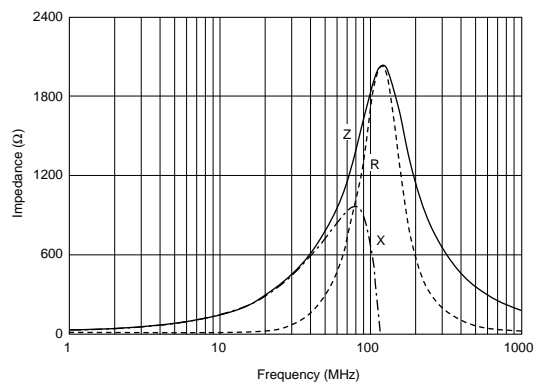

BLM18BD222SN1

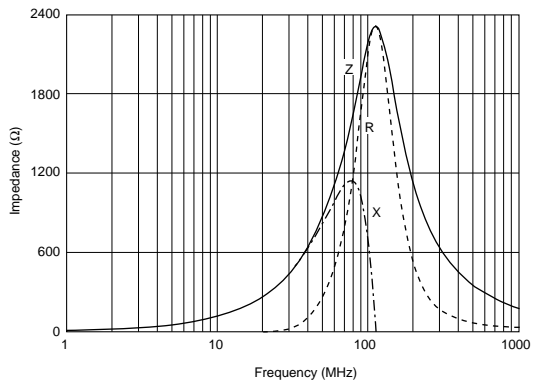

BLM18BD252SN1

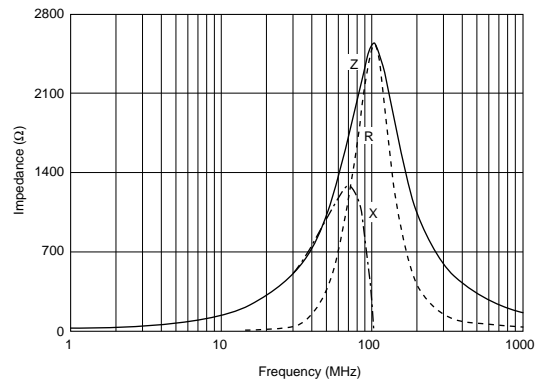

1

BLM21B Series (0805 Size)

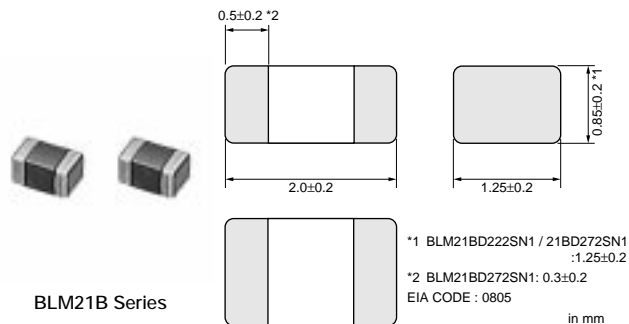

Part Number	Impedance (at 100MHz, 20 degree C) (ohm)	Rated Current (mA)	DC Resistance (max.) (ohm)	Operating Temperature Range (°C)
BLM21BB050SN1	5 ±25%	500	0.07	-55 to 125
BLM21BB600SN1	60 ±25%	200	0.20	-55 to 125
BLM21BB750SN1	75 ±25%	200	0.25	-55 to 125
BLM21BB121SN1	120 ±25%	200	0.25	-55 to 125
BLM21BD121SN1	120 ±25%	200	0.25	-55 to 125
BLM21BB151SN1	150 ±25%	200	0.25	-55 to 125
BLM21BD151SN1	150 ±25%	200	0.25	-55 to 125
BLM21BB201SN1	200 ±25%	200	0.35	-55 to 125
BLM21BB221SN1	220 ±25%	200	0.35	-55 to 125
BLM21BD221SN1	220 ±25%	200	0.25	-55 to 125
BLM21BB331SN1	330 ±25%	200	0.40	-55 to 125
BLM21BD331SN1	330 ±25%	200	0.30	-55 to 125
BLM21BD421SN1	420 ±25%	200	0.30	-55 to 125
BLM21BB471SN1	470 ±25%	200	0.45	-55 to 125
BLM21BD471SN1	470 ±25%	200	0.35	-55 to 125
BLM21BD601SN1	600 ±25%	200	0.35	-55 to 125
BLM21BD751SN1	750 ±25%	200	0.40	-55 to 125
BLM21BD102SN1	1000 ±25%	200	0.40	-55 to 125
BLM21BD152SN1	1500 ±25%	200	0.45	-55 to 125
BLM21BD182SN1	1800 ±25%	200	0.50	-55 to 125
BLM21BD222TN1	2200 ±25%	200	0.60	-55 to 125
BLM21BD222SN1	2250 (Typ.)	200	0.60	-55 to 125
BLM21BD272SN1	2700 ±25%	200	0.80	-55 to 125

■ Impedance-Frequency (Typical)

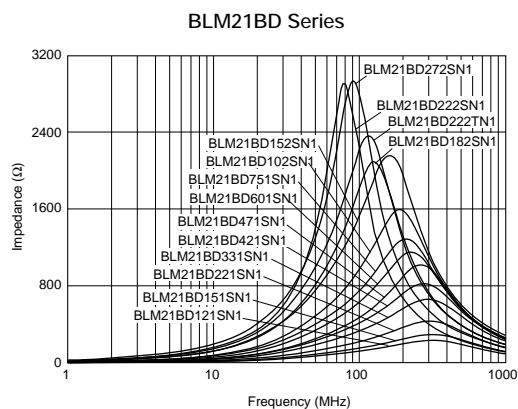
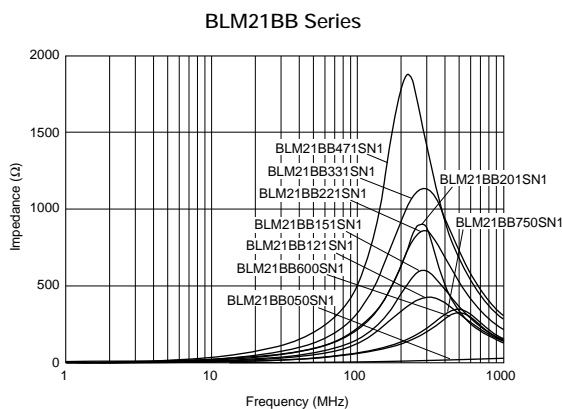

Continued on the following page. ↗

Continued from the preceding page.

Impedance-Frequency Characteristics

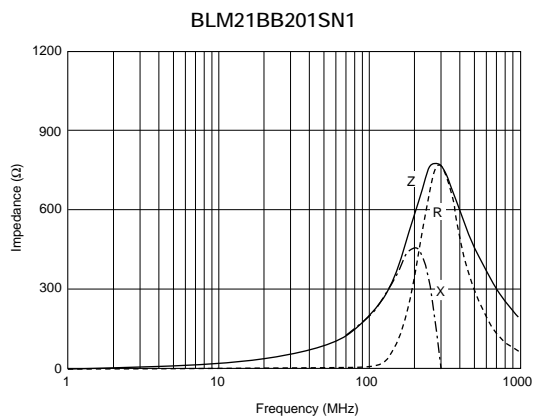
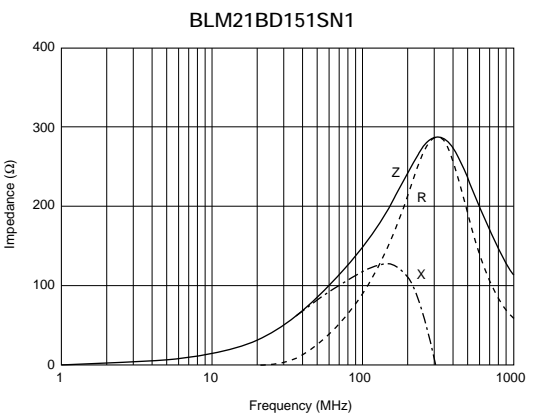
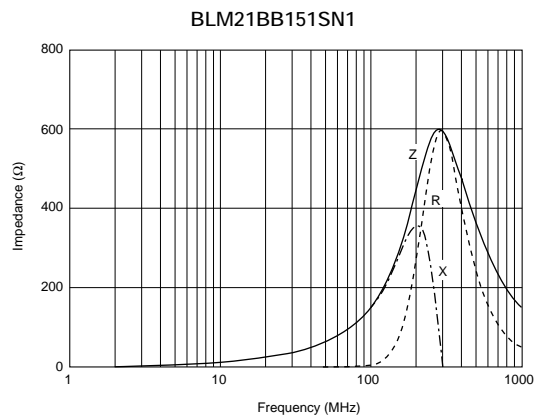
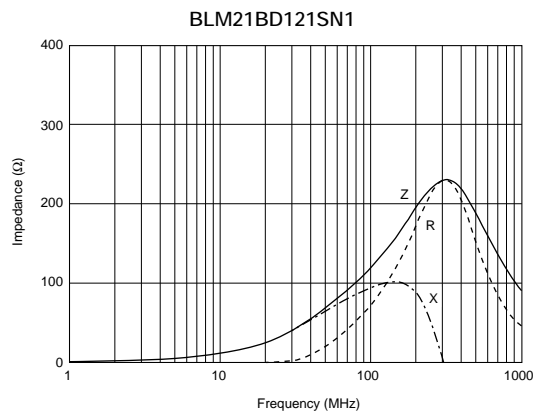
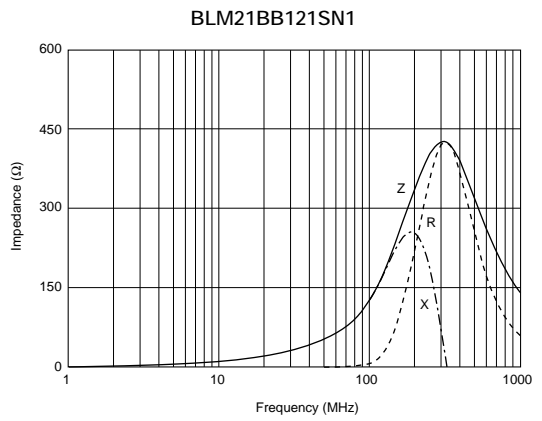
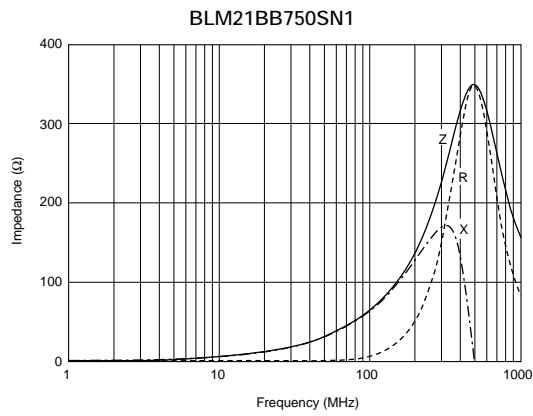
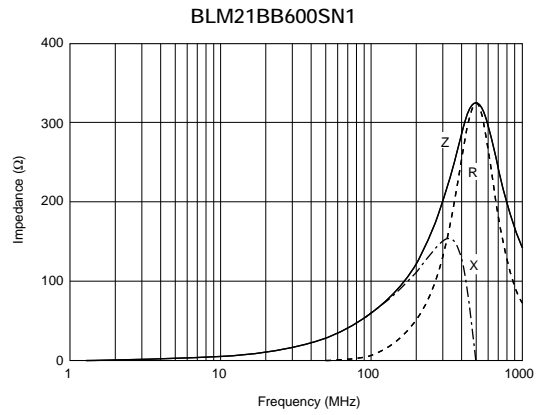
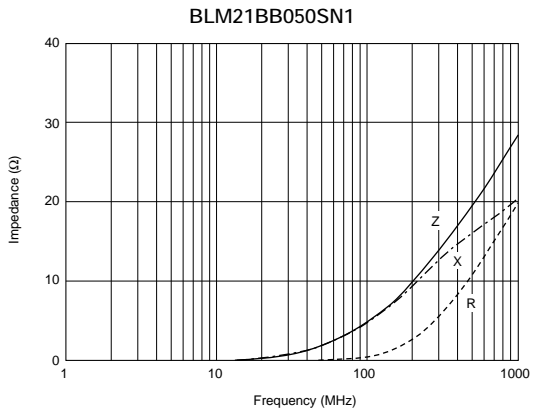

Continued on the following page. ↗

Continued from the preceding page.

Impedance-Frequency Characteristics

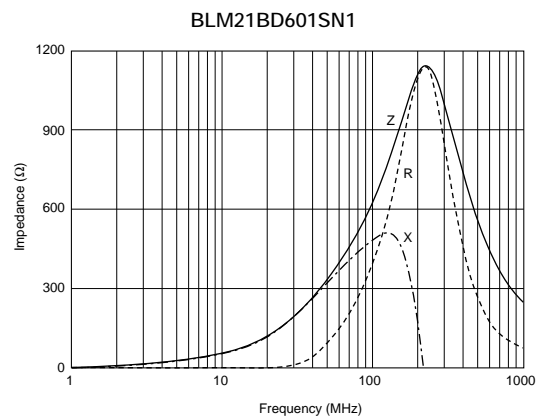
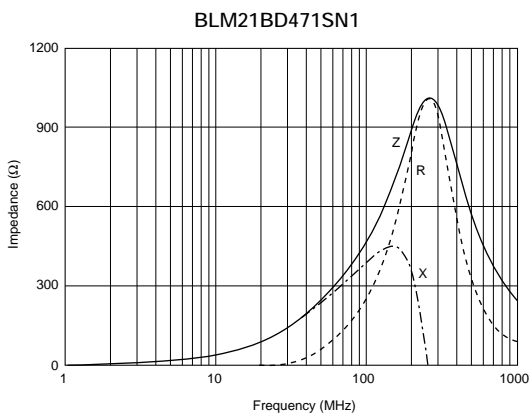
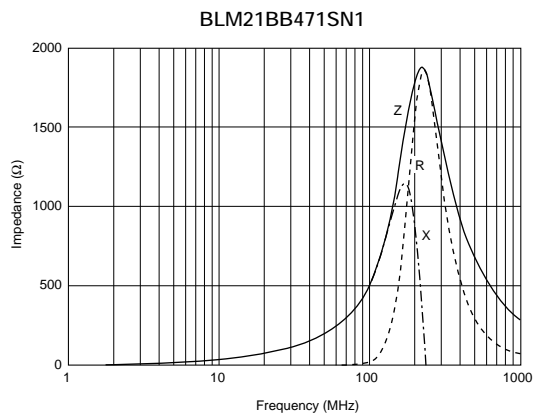
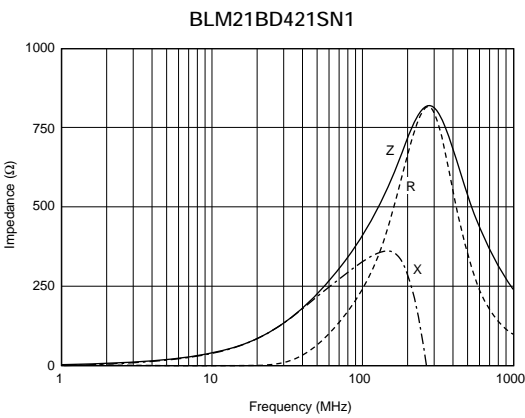
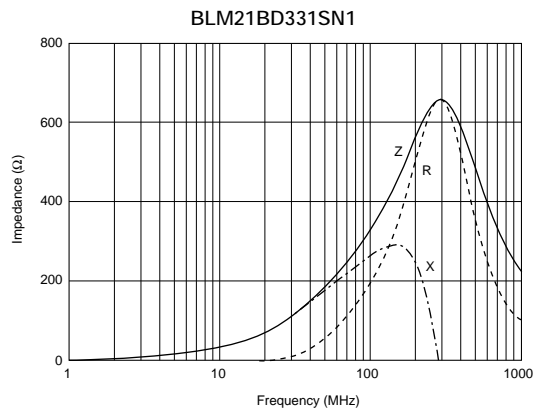
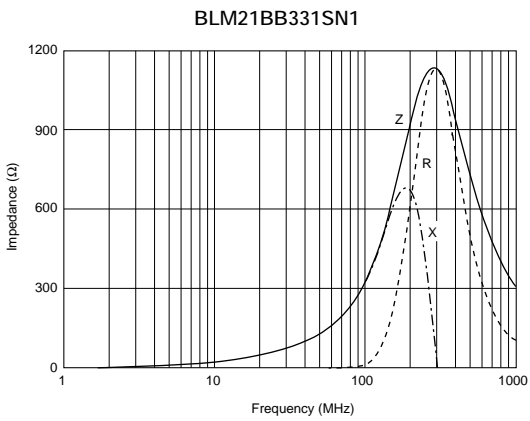
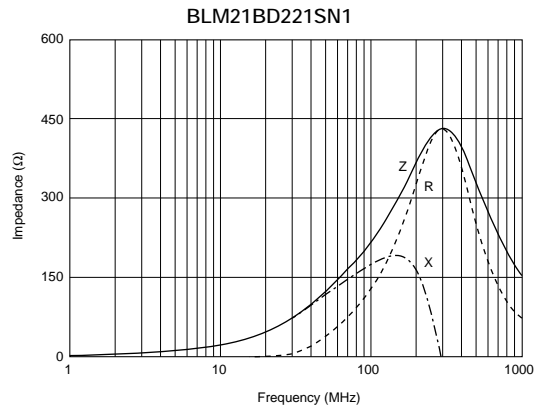
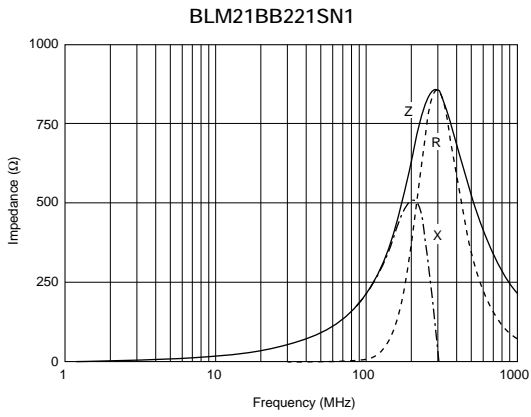

Continued on the following page. ↗

Continued from the preceding page.

Impedance-Frequency Characteristics

BLM21BD751SN1

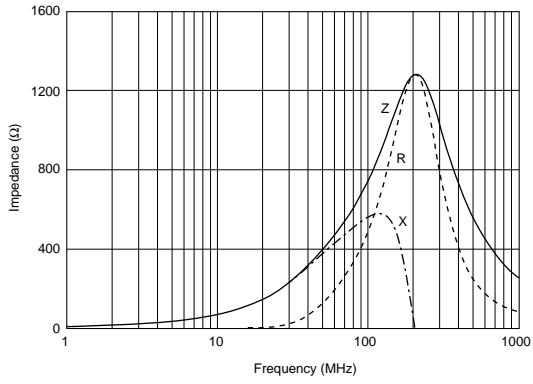

BLM21BD102SN1

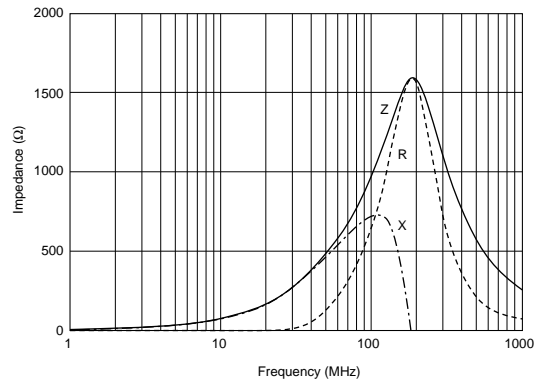

BLM21BD152SN1

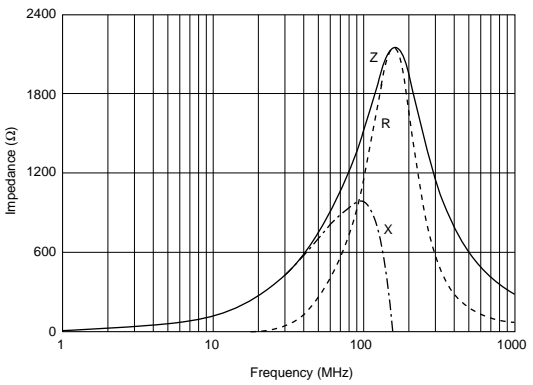

BLM21BD182SN1

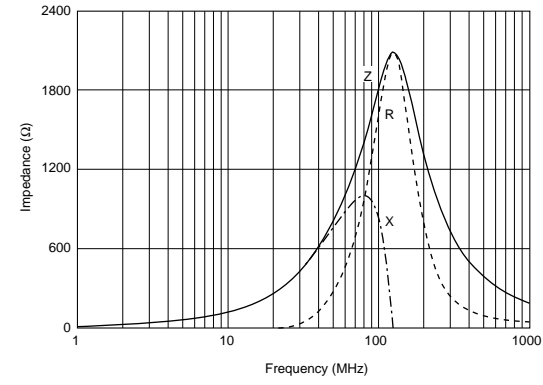

BLM21BD222TN1

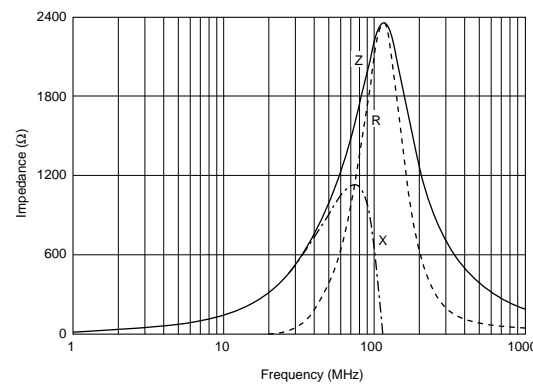

BLM21BD222SN1

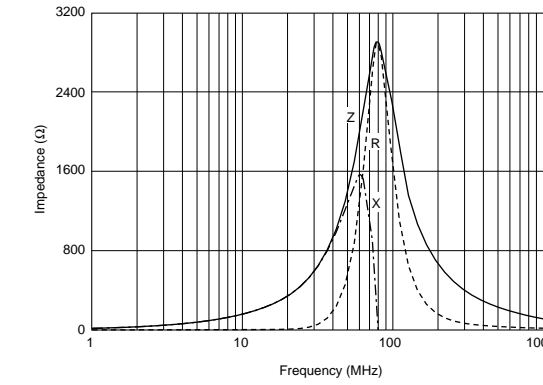

BLM21BD272SN1

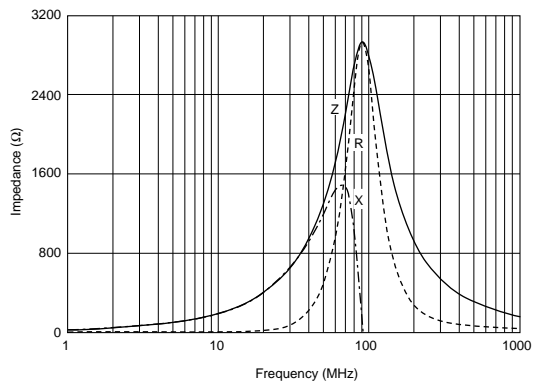

BLM31B Series (1206 Size)

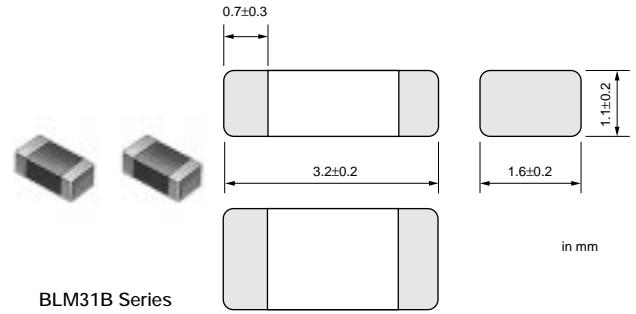

Part Number	Impedance (at 100MHz, 20 degree C) (ohm)	Rated Current (mA)	DC Resistance (max.) (ohm)	Operating Temperature Range (°C)
BLM31BE601FN1	600 ±25%	300	0.35	-55 to 125

■ Impedance-Frequency (Typical)

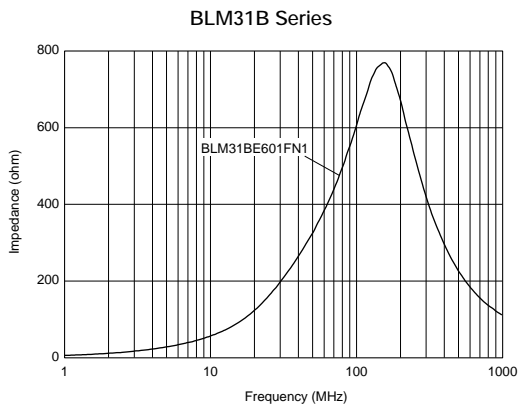

■ Impedance-Frequency Characteristics

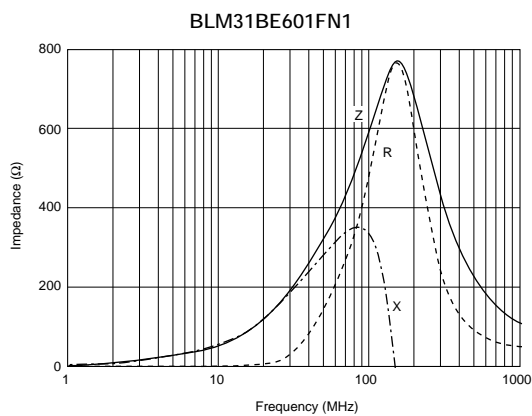

■ Features (BLM_R Series)

The chip ferrite bead BLM series comprises ferrite beads in the shape of a chip. This ferrite bead generates a high impedance which at high frequencies mainly consists of a resistance element. The BLM series is effective in circuits without stable ground lines because the BLM series does not need a connection to ground.

The nickel barrier structure of the external electrodes provides excellent solder heat resistance. The BLM_R series can be used in a digital interface. Resistance of BLM_R series especially grows in the lower frequency range. Therefore BLM_R series is less effective for digital signal waveform at low frequency range and can suppress the ringing.

■ Equivalent Circuit

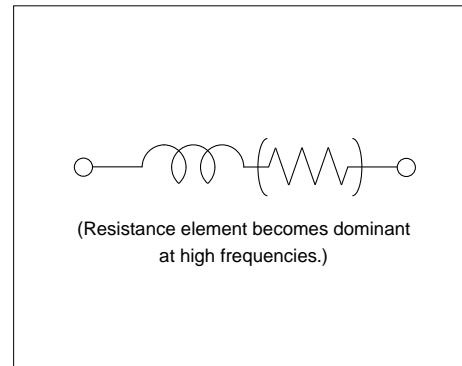

1

BLM18R Series (0603 Size)

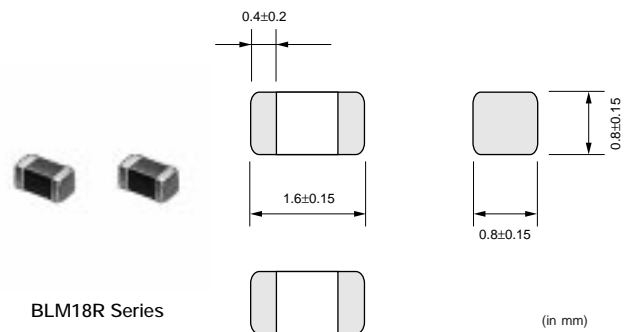

Part Number	Impedance (at 100MHz, 20 degree C) (ohm)	Rated Current (mA)	DC Resistance (max.) (ohm)	Operating Temperature Range (°C)
BLM18RK121SN1	120 ±25%	200	0.25	-55 to 125
BLM18RK221SN1	220 ±25%	200	0.30	-55 to 125
BLM18RK471SN1	470 ±25%	200	0.50	-55 to 125
BLM18RK601SN1	600 ±25%	200	0.60	-55 to 125
BLM18RK102SN1	1000 ±25%	200	0.80	-55 to 125

■ Impedance-Frequency (Typical)

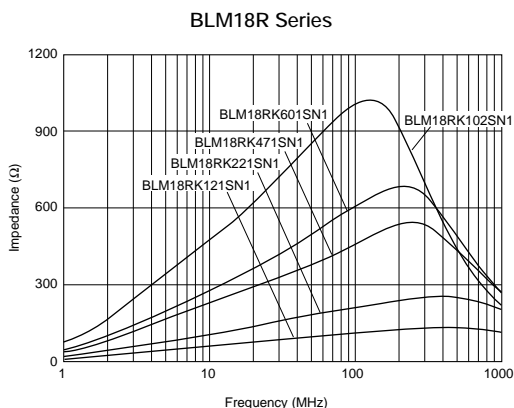

■ Impedance-Frequency Characteristics

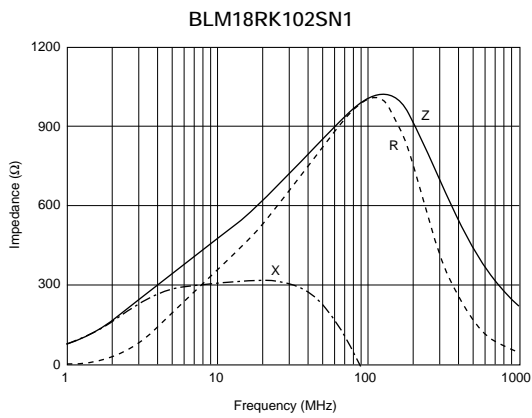
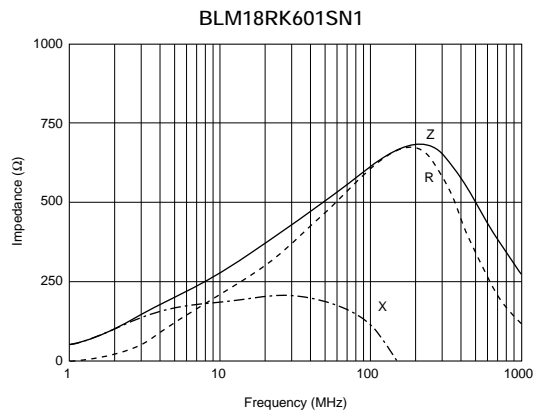
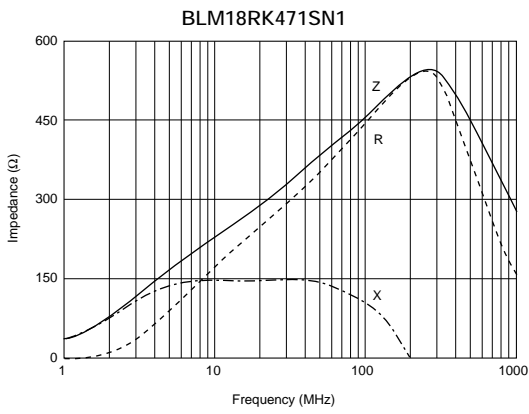
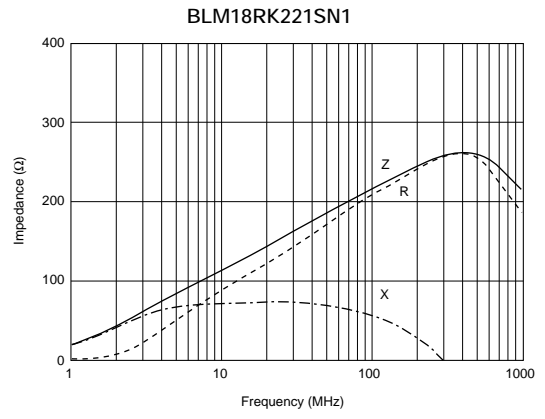
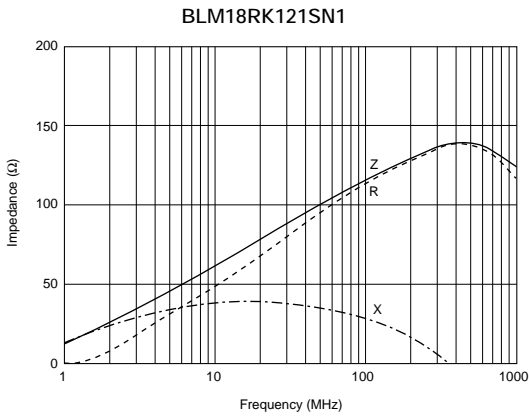

1

BLM21R Series (0805 Size)

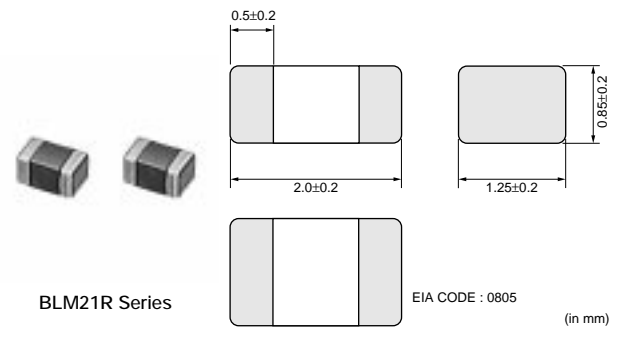

1

Part Number	Impedance (at 100MHz, 20 degree C) (ohm)	Rated Current (mA)	DC Resistance (max.) (ohm)	Operating Temperature Range (°C)
BLM21RK121SN1	120 ±25%	200	0.15	-55 to 125
BLM21RK221SN1	220 ±25%	200	0.20	-55 to 125
BLM21RK471SN1	470 ±25%	200	0.25	-55 to 125
BLM21RK601SN1	600 ±25%	200	0.30	-55 to 125
BLM21RK102SN1	1000 ±25%	200	0.50	-55 to 125

■ Impedance-Frequency (Typical)

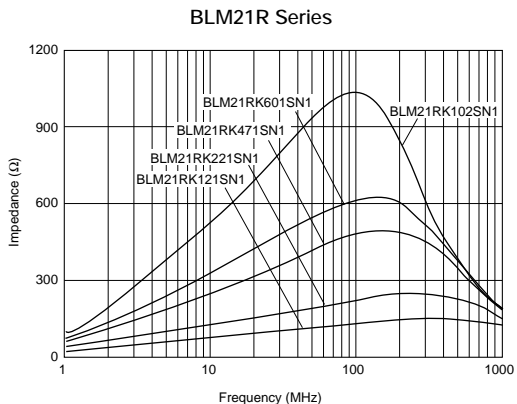

■ Impedance-Frequency Characteristics

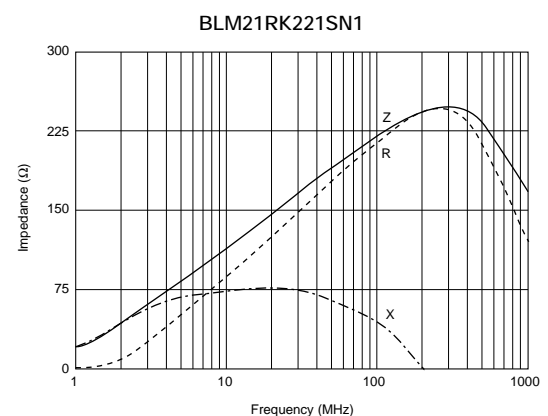
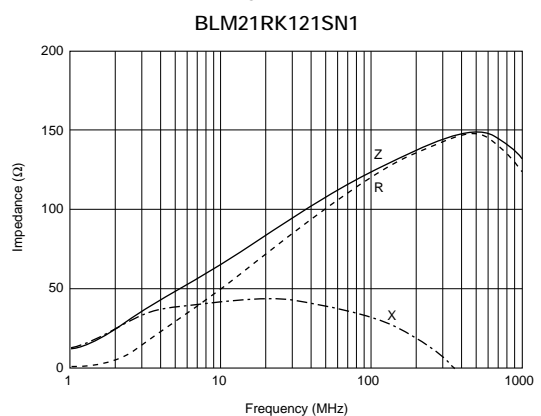

Continued on the following page. ↗

↳ Continued from the preceding page.

■ Impedance-Frequency Characteristics

BLM21RK471SN1

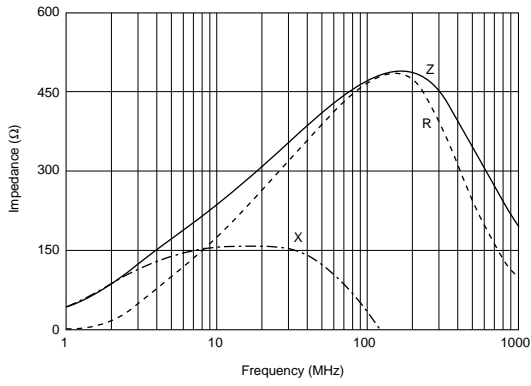

BLM21RK601SN1

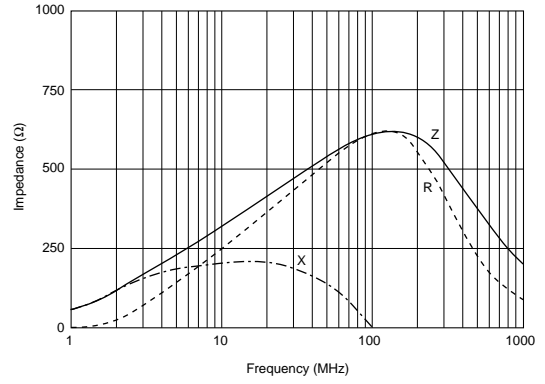

BLM21RK102SN1

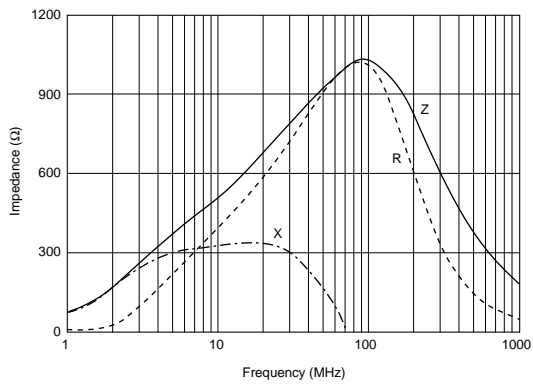

1

■ Features (BLM_P Series)

The chip ferrite bead BLM series comprises ferrite beads in the shape of a chip. This ferrite bead generates a high impedance which at high frequencies mainly consists of a resistance element. The BLM series is effective in circuits without stable ground lines because the BLM series does not need a connection to ground.

The nickel barrier structure of the external electrodes provides excellent solder heat resistance. The BLM_P series can be used in high current circuits due to its low DC resistance. It can match power lines to a maximum of 6A DC (BLM41P).

■ Equivalent Circuit

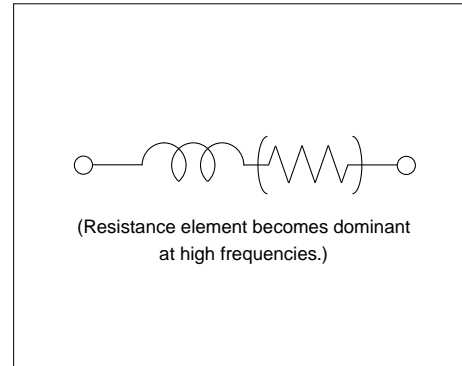

1

BLM18P Series (0603 Size)

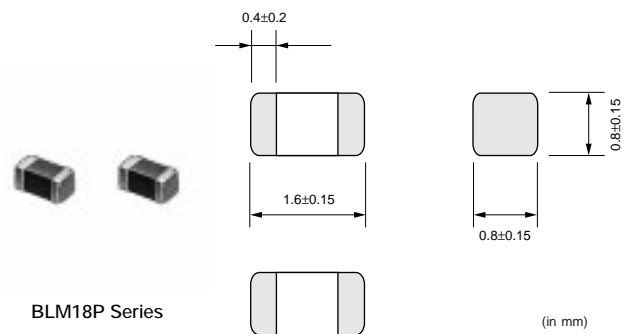

Part Number	Impedance (at 100MHz, 20 degree C) (ohm)	Rated Current (mA)	DC Resistance (max.) (ohm)	Operating Temperature Range (°C)
BLM18PG300SN1	30 (Typ.)	1000	0.05	-55 to 125
BLM18PG330SN1	33 ±25%	3000	0.025	-55 to 125
BLM18PG600SN1	60 (Typ.)	500	0.10	-55 to 125
BLM18PG121SN1	120 ±25%	2000	0.05	-55 to 125
BLM18PG181SN1	180 ±25%	1500	0.09	-55 to 125

At rated current upper than 1500mA, derating is required.
Please refer P. 51, "Derating of Rated Current".

■ Impedance-Frequency (Typical)

BLM18P Series

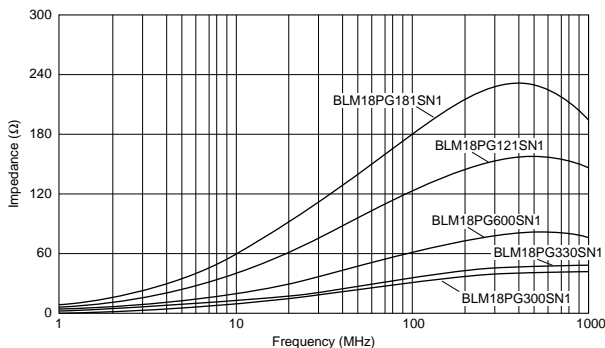

■ Impedance-Frequency Characteristics

BLM18PG300SN1

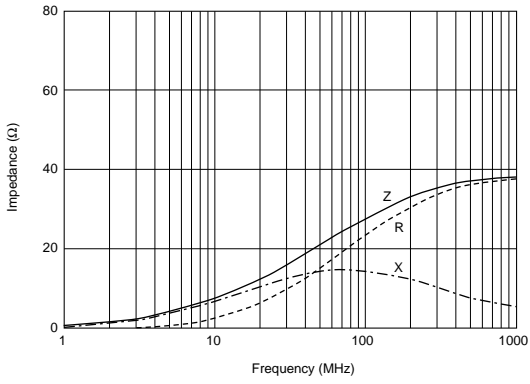

BLM18PG330SN1

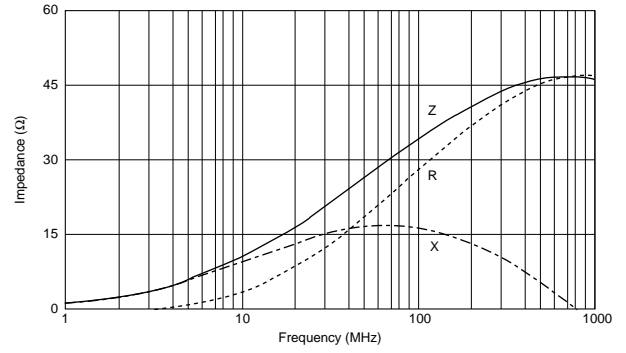

BLM18PG600SN1

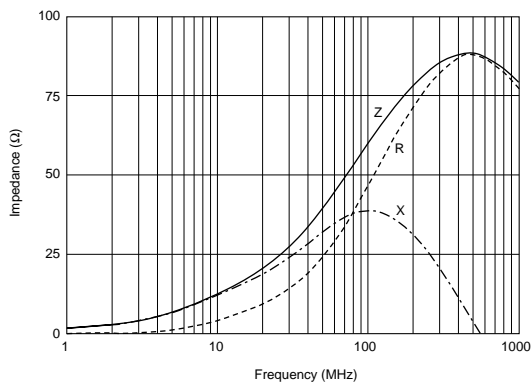

BLM18PG121SN1

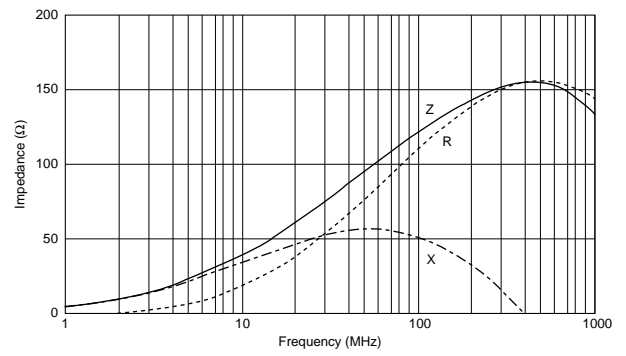

BLM18PG181SN1

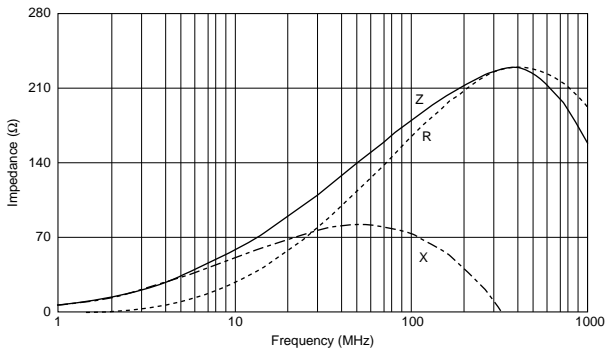

1

BLM21P Series (0805 Size)

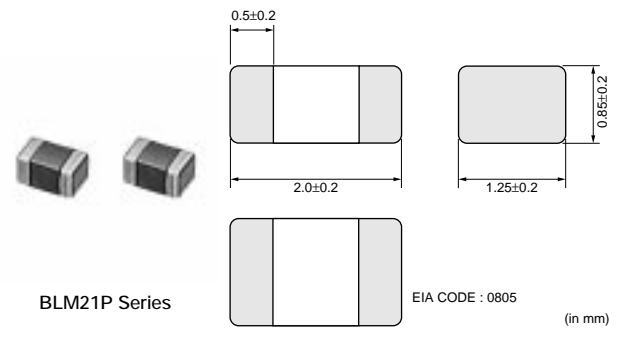

Part Number	Impedance (at 100MHz, 20 degree C) (ohm)	Rated Current (mA)	DC Resistance (max.) (ohm)	Operating Temperature Range (°C)
BLM21PG220SN1	22 ±25%	6000	0.01	-55 to 125
BLM21PG300SN1	30 (Typ.)	3000	0.015	-55 to 125
BLM21PG600SN1	60 ±25%	3000	0.025	-55 to 125
BLM21PG221SN1	220 ±25%	2000	0.050	-55 to 125
BLM21PG331SN1	330 ±25%	1500	0.09	-55 to 125

At rated current upper than 1500mA, derating is required.
Please refer P. 51, "Derating of Rated Current".

■ Impedance-Frequency (Typical)

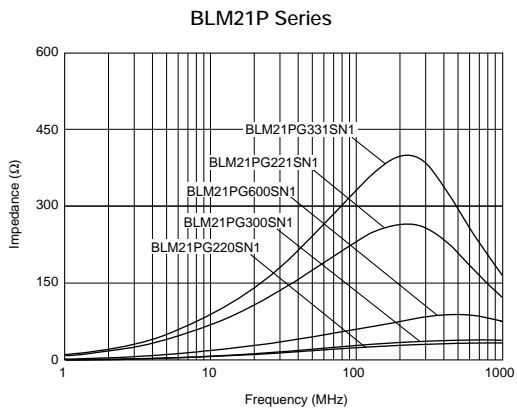

■ Impedance-Frequency Characteristics

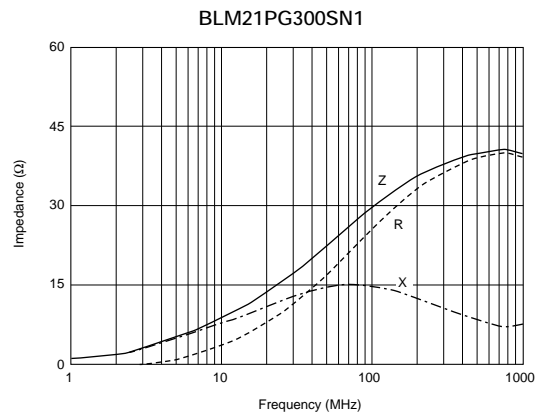
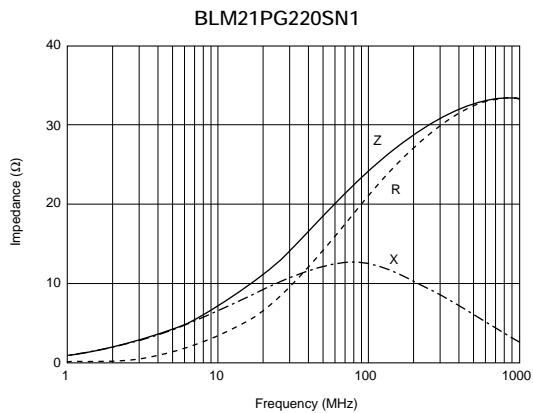

Continued on the following page. ↗

Continued from the preceding page.

Impedance-Frequency Characteristics

BLM21PG600SN1

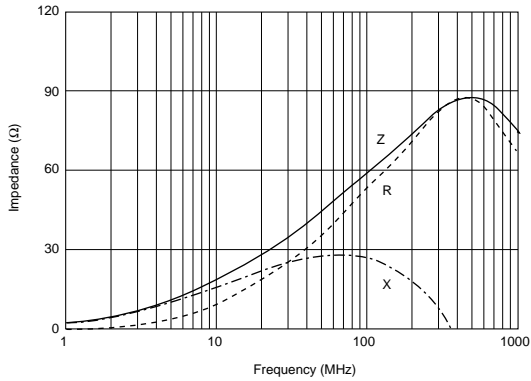

BLM21PG221SN1

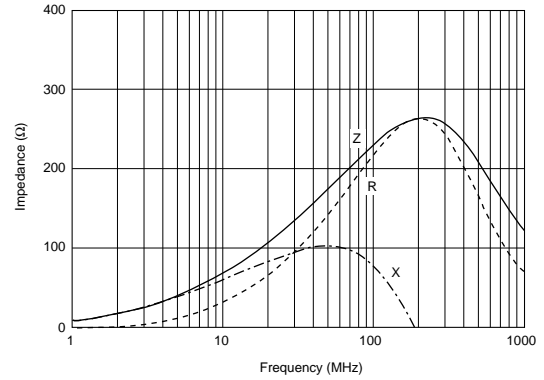

BLM21PG331SN1

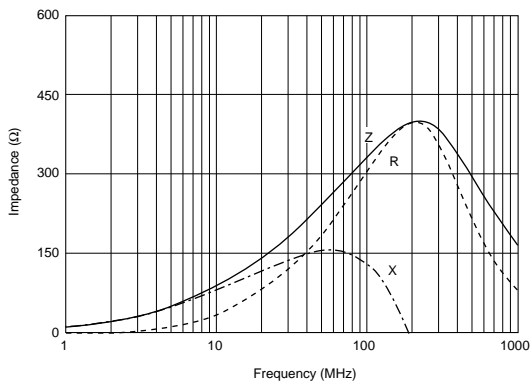

BLM31P Series (1206 Size)

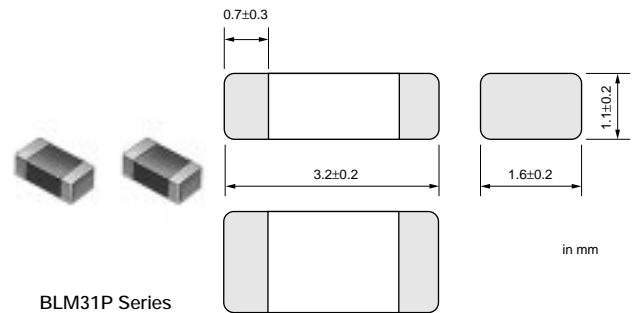

Part Number	Impedance (at 100MHz, 20 degree C) (ohm)	Rated Current (mA)	DC Resistance (max.) (ohm)	Operating Temperature Range (°C)
BLM31PG330SN1	33 ±25%	6000	0.01	-55 to 125
BLM31PG500SN1	50 (Typ.)	3000	0.025	-55 to 125
BLM31PG121SN1	120 ±25%	3000	0.025	-55 to 125
BLM31PG391SN1	390 ±25%	2000	0.05	-55 to 125
BLM31PG601SN1	600 ±25%	1500	0.09	-55 to 125

At rated current upper than 1500mA, derating is required.
Please refer P. 51, "Derating of Rated Current".

■ Impedance-Frequency (Typical)

BLM31P Series

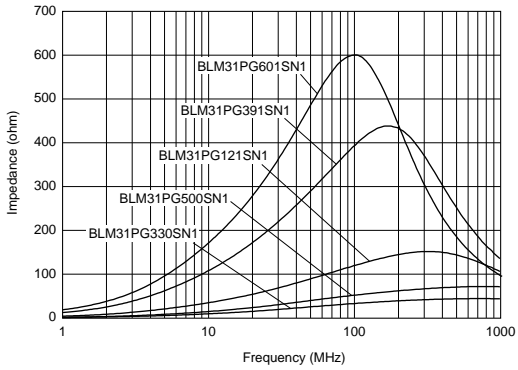

■ Impedance-Frequency Characteristics

BLM31PG330SN1

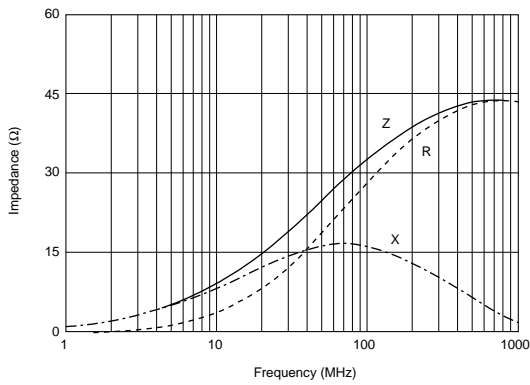

BLM31PG500SN1

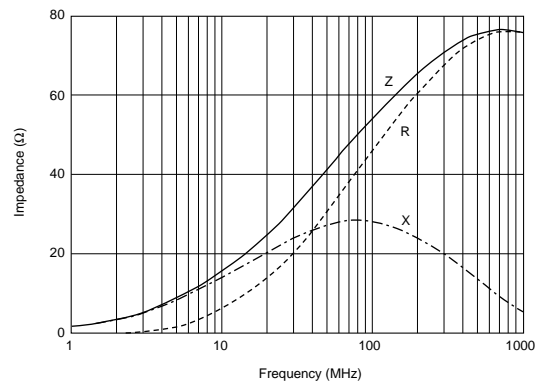

BLM31PG121SN1

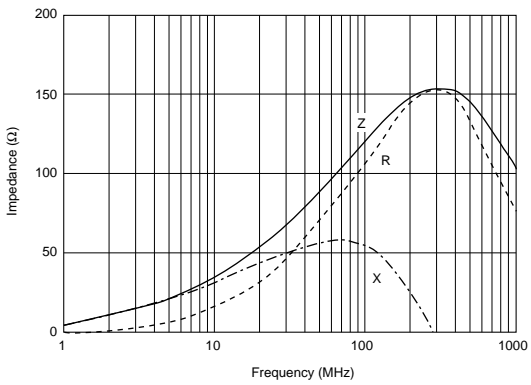

BLM31PG391SN1

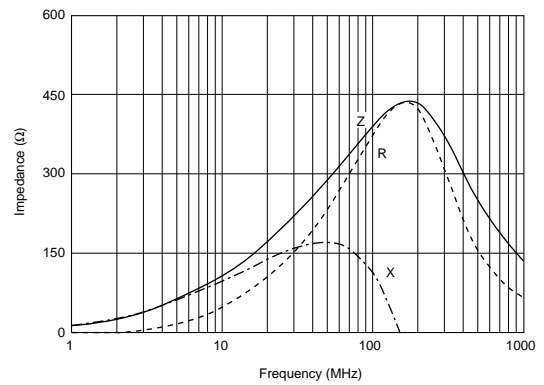

BLM31PG601SN1

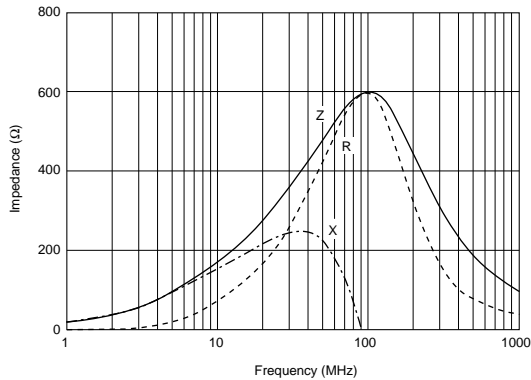

BLM41P Series (1806 Size)

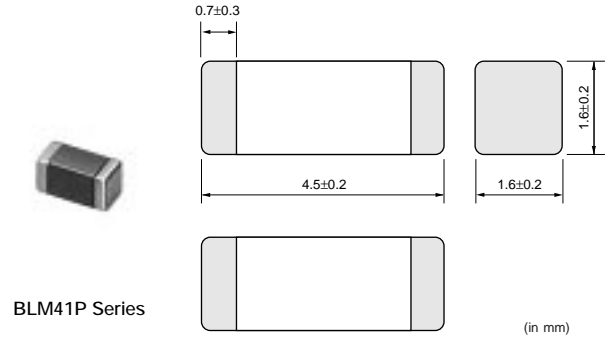

Part Number	Impedance (at 100MHz, 20 degree C) (ohm)	Rated Current (mA)	DC Resistance (max.) (ohm)	Operating Temperature Range (°C)
BLM41PG600SN1	60 (Typ.)	6000	0.01	-55 to 125
BLM41PG750SN1	75 (Typ.)	3000	0.025	-55 to 125
BLM41PF800SN1	80 (Typ.)	1000	0.10	-55 to 125
BLM41PG181SN1	180 ±25%	3000	0.025	-55 to 125
BLM41PG471SN1	470 ±25%	2000	0.05	-55 to 125
BLM41PG102SN1	1000 ±25%	1500	0.09	-55 to 125

At rated current upper than 1500mA, derating is required.
Please refer P. 51, "Derating of Rated Current".

■ Impedance-Frequency (Typical)

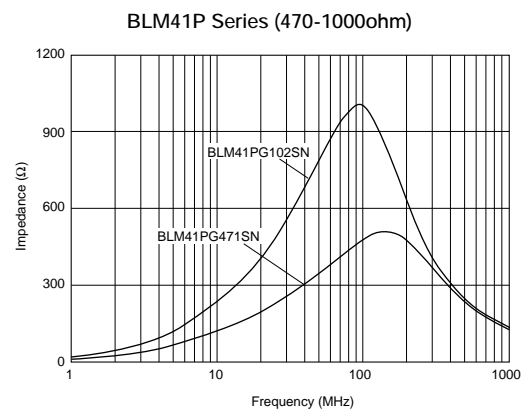
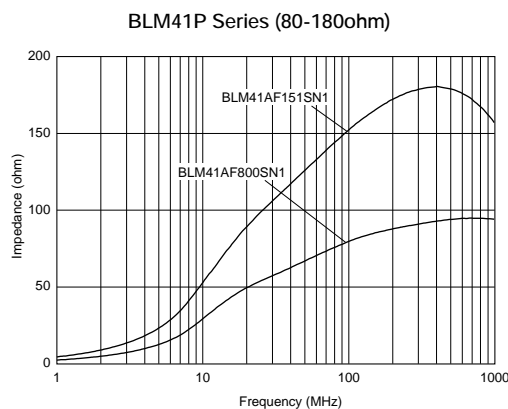

■ Impedance-Frequency Characteristics

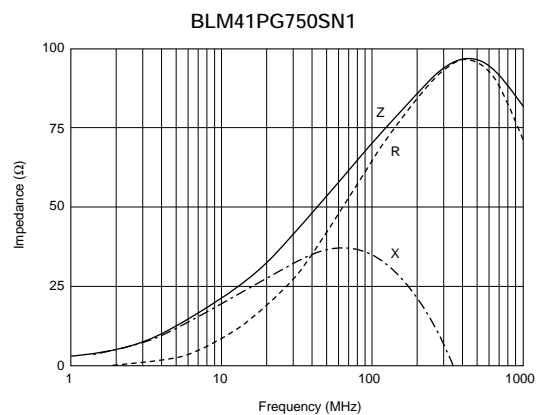
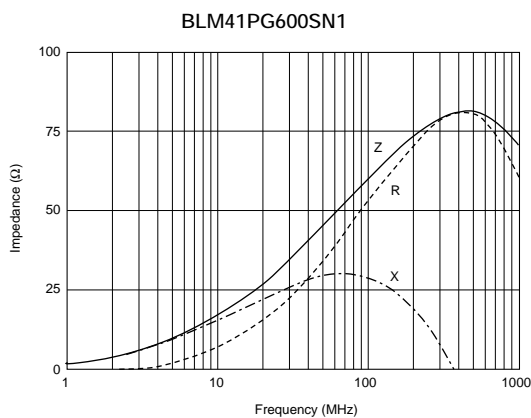

Continued on the following page. ↗

Continued from the preceding page.

Impedance-Frequency Characteristics

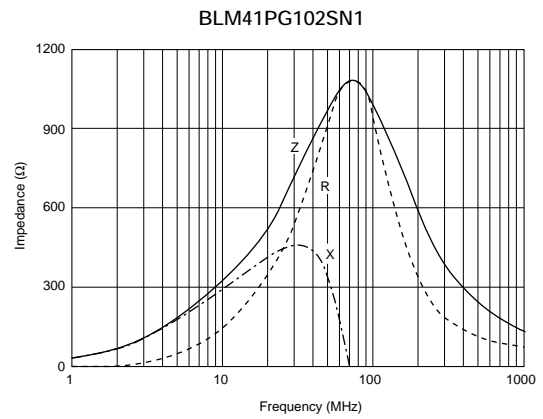
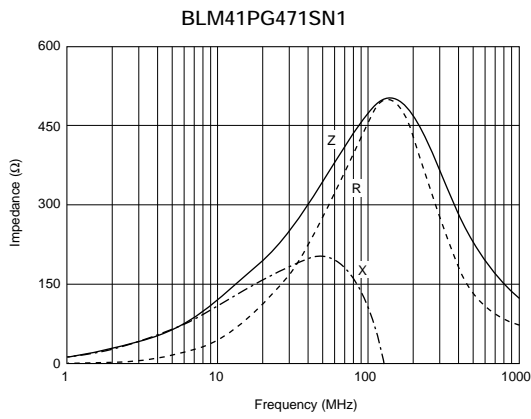
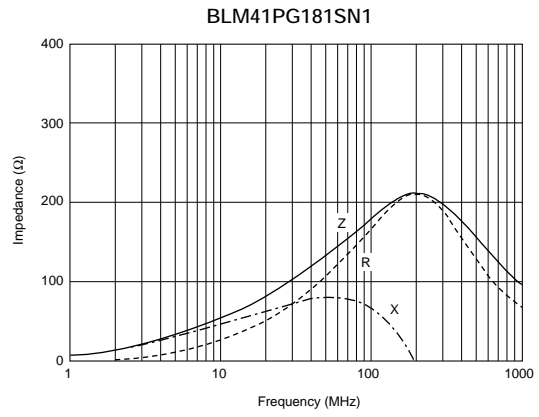
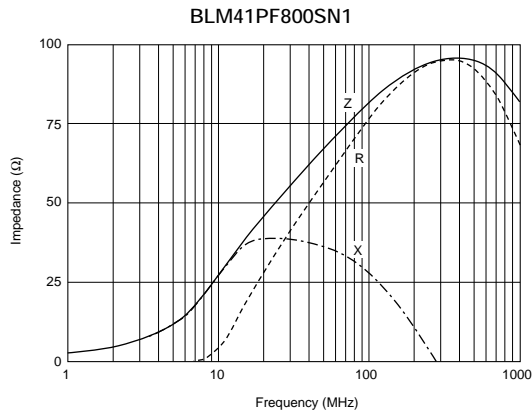

Notice (Rating)

In operating temperatures exceeding +85°C, derating of current is necessary for chip Ferrite Beads for which rated current is 1.5A or over. Please apply the derating curve shown below according to the operating temperature.

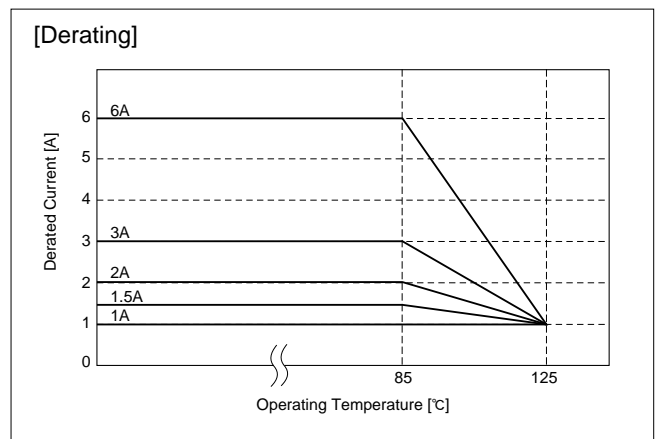

Noise Suppression Effect of BLM_R Series

Waveform Distortion Suppressing Performance of BLM□□R Series

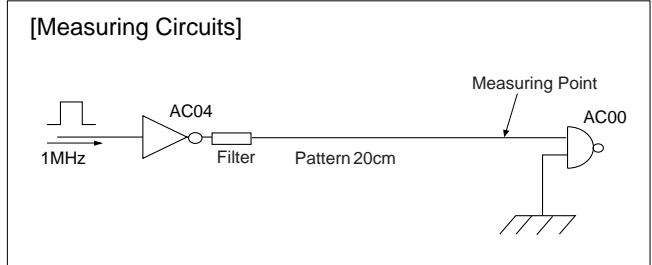

Type of Filter	EMI Suppression Effect / Description		
Initial (No filter)	<p>Signal waveform (100nsec/div, 2V/div)</p>	<p>Expand (10nsec/div, 2V/div)</p>	<p>Spectrum</p>
Resister (47Ω) is used	<p>Signal waveform (100nsec/div, 2V/div)</p>	<p>Expand (10nsec/div, 2V/div)</p>	<p>Spectrum</p>
BLM18RK221SN1 (220Ω at 100MHz) is used	<p>Signal waveform (100nsec/div, 2V/div)</p>	<p>Expand (10nsec/div, 2V/div)</p>	<p>Spectrum</p>
	<p>BLM18R has excellent performance for noise suppression and waveform distortion suppression. BLM18R suppresses drastically not only spectrum level in more than 100MHz range but waveform distortion.</p>		

On-Board Type (DC) EMI Suppression Filters (EMIFIL®)



GHz Noise Suppression Chip Ferrite Beads BLM18H/BLM18E Series

BLM18H/BLM18E series has a modified internal electrode structure, that minimizes stray capacitance and increases the effective frequency range.

■ Features (BLM18H series)

1. BLM18H series is realized high impedance at 1GHz and suitable for noise suppression from 500MHz to GHz range. The impedance value of HG/HD-type is about three times as large as that of A/B-type at 1GHz, though the impedance characteristic of HG/HD-type is similar to A-type at 100MHz or less.
2. HG-type is effective in noise suppression in wide frequency range (several MHz to several GHz). HB/HD-type for high-speed signal line provides a sharper roll-off after the cut off frequency. HK-type for digital interface is effective in suppressing the ringing because resistance especially grows in the lower frequency.
3. The magnetic shielded structure minimizes crosstalk.

■ Features (BLM18E series)

1. Low DC Resistance and a large Rated Current are suitable for noise suppression of the driver circuit.
2. Excellent direct current characteristics
3. Thin type (t=0.5mm) is suitable for small and low profile equipment such as DSC, cellular phones.

■ Equivalent Circuit

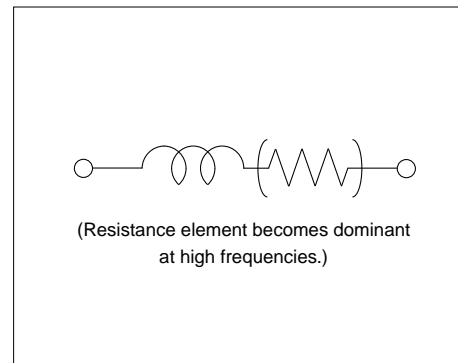

1

BLM18H Series (0603 Size)

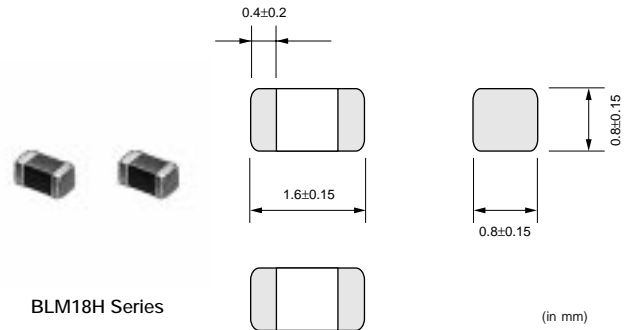

Part Number	Impedance (at 100MHz, 20 degree C) (ohm)	Impedance (at 1GHz, 25 degree C) (ohm)	Rated Current (mA)	DC Resistance (max.) (ohm)	Operating Temperature Range (°C)
BLM18HG471SN1	470 ±25%	600 (Typ.)	200	0.85	-55 to 125
BLM18HG601SN1	600 ±25%	700 (Typ.)	200	1.00	-55 to 125
BLM18HG102SN1	1000 ±25%	1000 (Typ.)	100	1.60	-55 to 125
BLM18HB121SN1	120 ±25%	500 ±40%	200	0.50	-55 to 125
BLM18HB221SN1	220 ±25%	1100 ±40%	100	0.80	-55 to 125
BLM18HB331SN1	330 ±25%	1600 ±40%	50	1.20	-55 to 125
BLM18HD471SN1	470 ±25%	1000 (Typ.)	100	1.20	-55 to 125
BLM18HD601SN1	600 ±25%	1200 (Typ.)	100	1.50	-55 to 125
BLM18HD102SN1	1000 ±25%	1700 (Typ.)	50	1.80	-55 to 125
BLM18HK331SN1	330 ±25%	400 ±40%	200	0.50	-55 to 125
BLM18HK471SN1	470 ±25%	600 ±40%	200	0.70	-55 to 125
BLM18HK601SN1	600 ±25%	700 ±40%	100	0.90	-55 to 125
BLM18HK102SN1	1000 ±25%	1200 ±40%	50	1.50	-55 to 125

■ Impedance-Frequency (Typical)

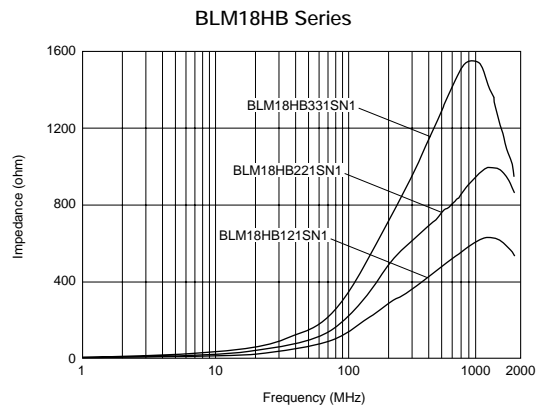
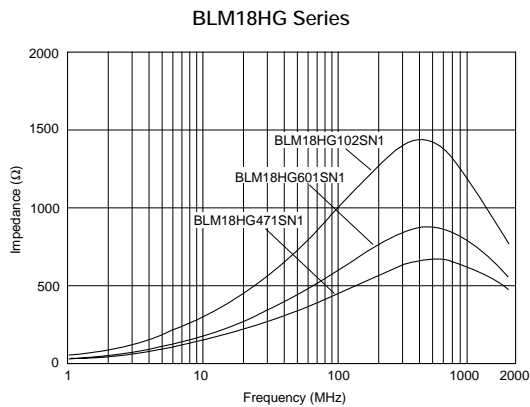

Continued on the following page.

Continued from the preceding page.

■ Impedance-Frequency (Typical)

BLM18HD Series

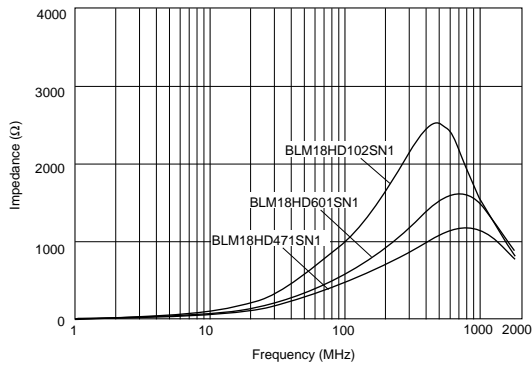

BLM18HK Series

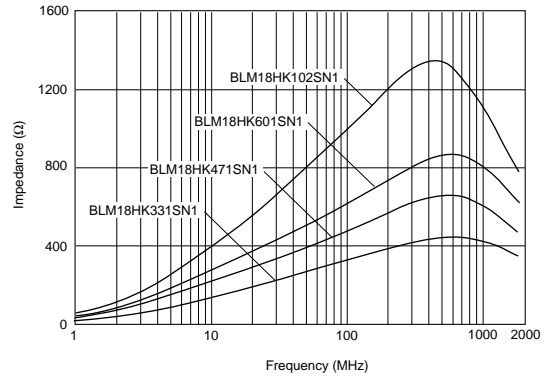

■ Impedance-Frequency Characteristics

BLM18HG471SN1

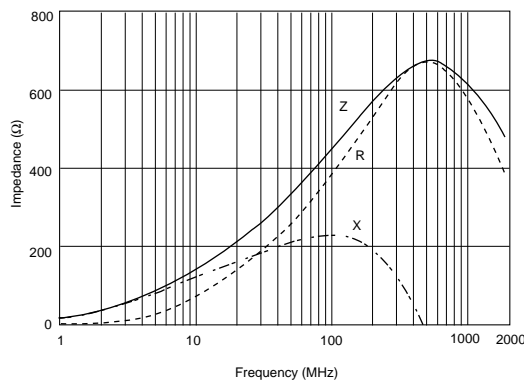

BLM18HG601SN1

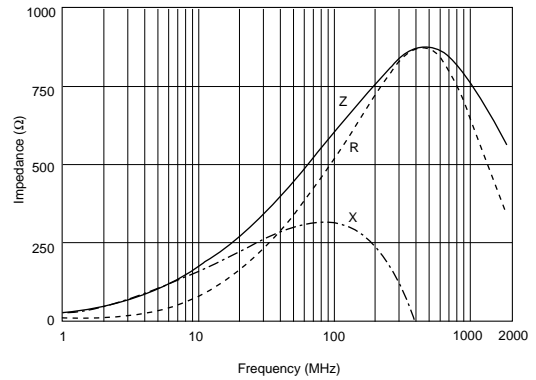

BLM18HG102SN1

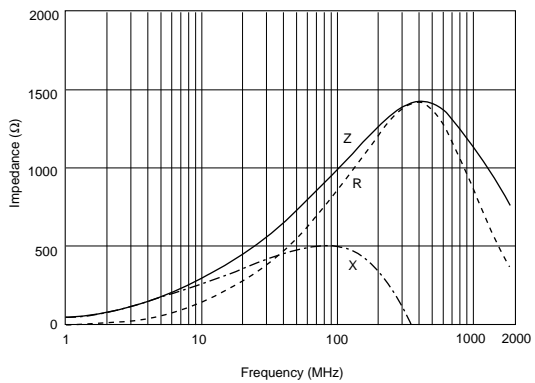

BLM18HB121SN1

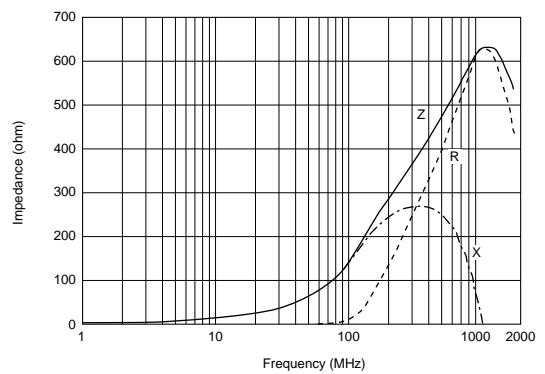

BLM18HB221SN1

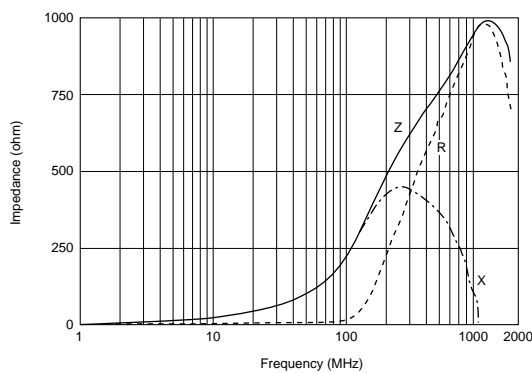

BLM18HB331SN1

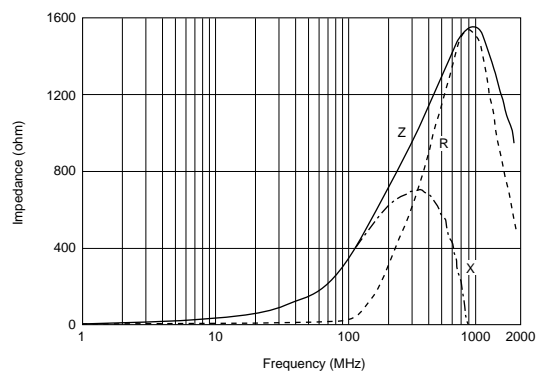

Continued on the following page. ↗

Continued from the preceding page.

Impedance-Frequency Characteristics

1

BLM18HD471SN1

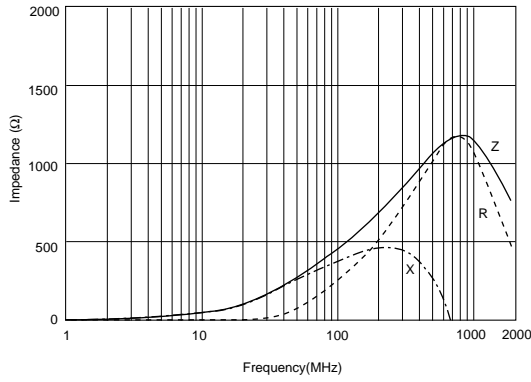

BLM18HD601SN1

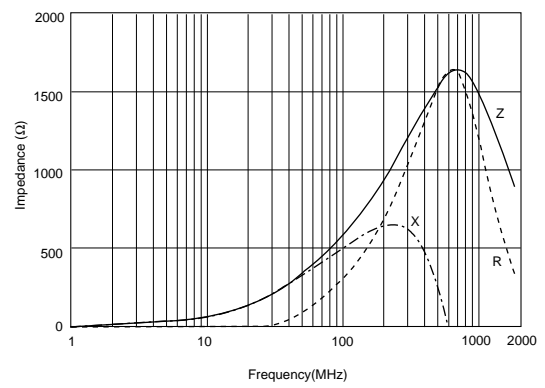

BLM18HD102SN1

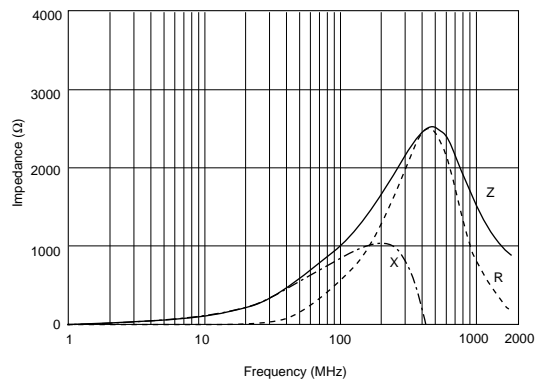

BLM18HK331SN1

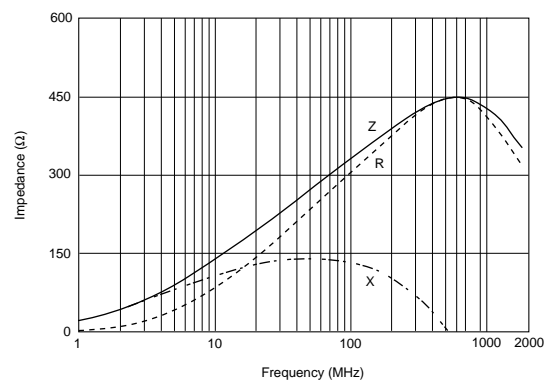

BLM18HK471SN1

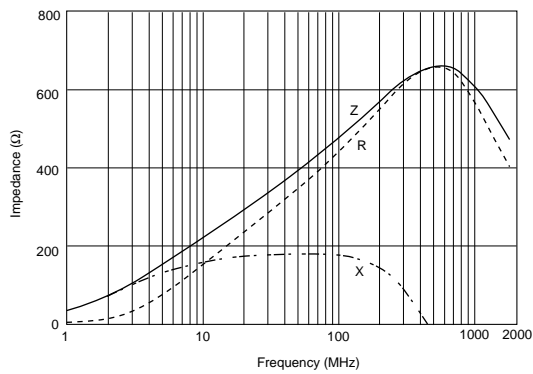

BLM18HK601SN1

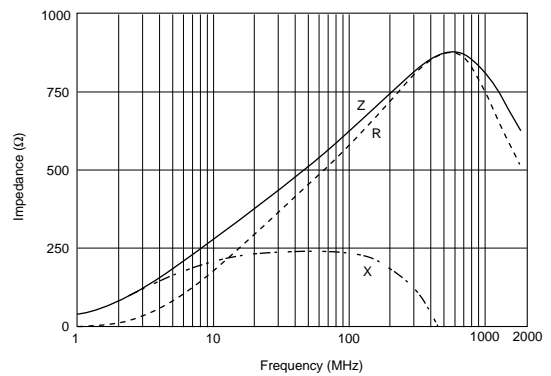

BLM18HK102SN1

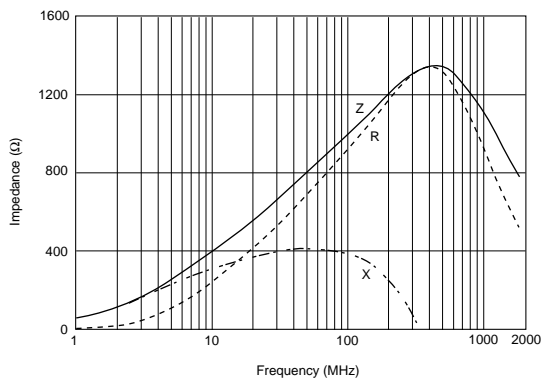

BLM18E Series (0603 Size)

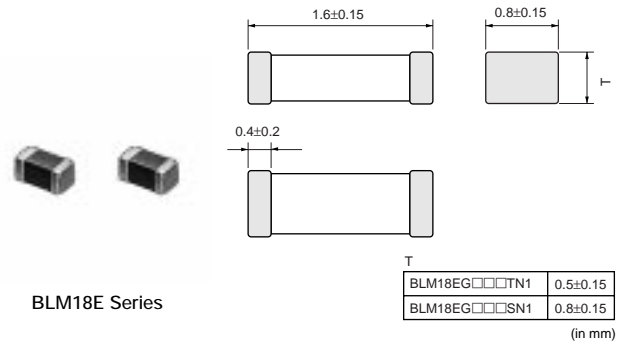

BLM18E Series

Part Number	Impedance (at 100MHz, 20 degree C) (ohm)	Impedance (at 1GHz, 25 degree C) (ohm)	Rated Current (mA)	DC Resistance (max.) (ohm)	Operating Temperature Range (°C)
BLM18EG101TN1	100 ±25%	140 (Typ.)	2000	0.04	-55 to 125
BLM18EG121SN1	120 ±25%	145 (Typ.)	2000	0.03	-55 to 125
BLM18EG391TN1	390 ±25%	520 (Typ.)	500	0.3	-55 to 125
BLM18EG601SN1	600 ±25%	700 (Typ.)	300	0.35	-55 to 125

At rated current 2000mA, derating is required.
Please refer P. 51, "Derating of Rated Current".

■ Impedance-Frequency (Typical)

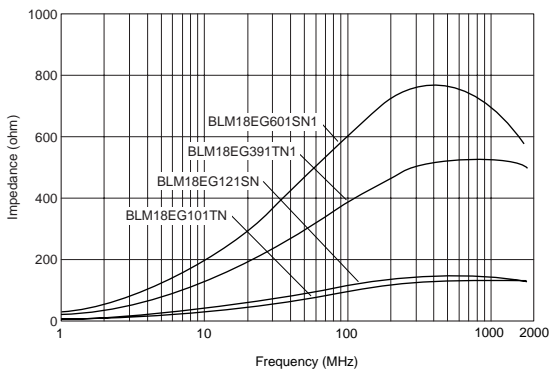

■ Impedance-Frequency Characteristics

BLM18EG101TN1

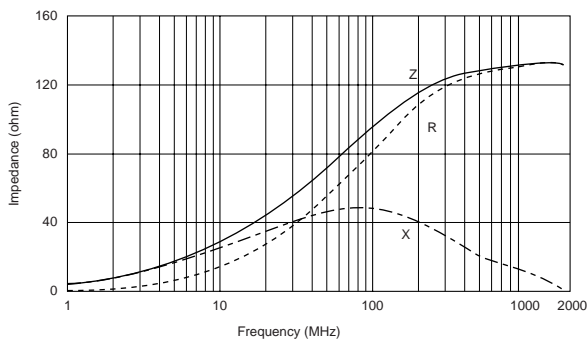

BLM18EG121SN1

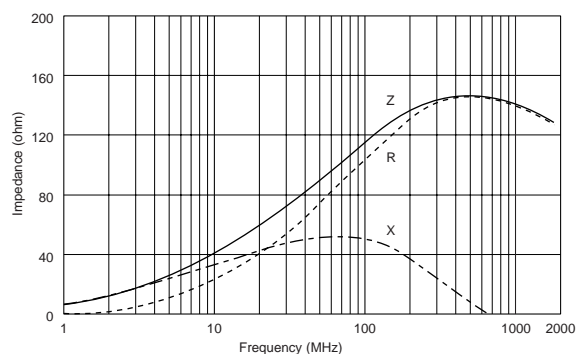

Continued on the following page. ↗

↳ Continued from the preceding page.

■ Impedance-Frequency Characteristics

BLM18EG391TN1

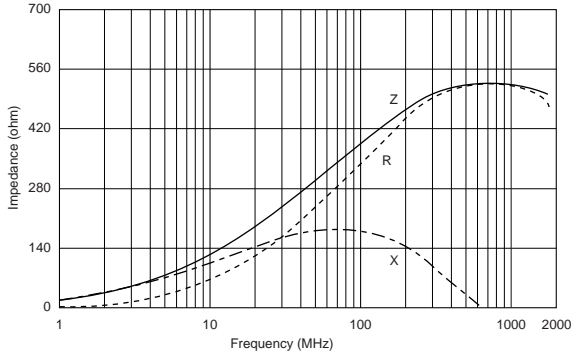

BLM18EG601SN1

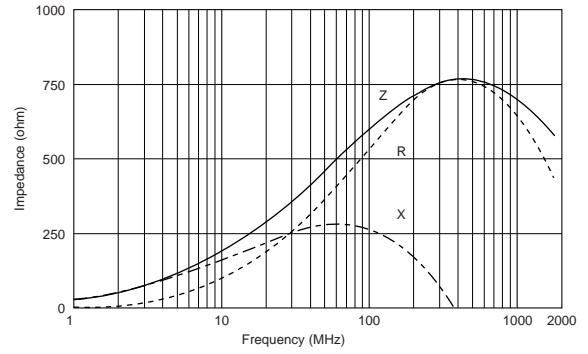

1

Noise Suppression Effect

■ Noise Suppression in UHF Range

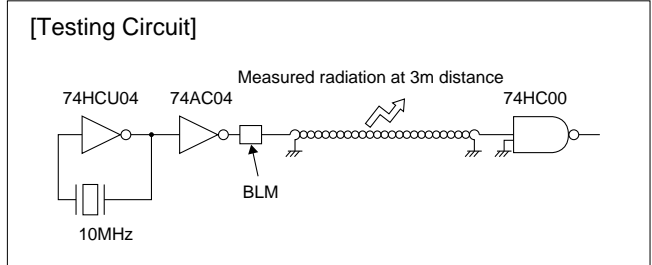

1

Type of Filter	EMI Suppression Effect	Description
Initial (No filter)		
Conventional Type BLM18AG102SN1 (1000Ω at 100MHz)		Current BLM are effective in suppressing noise in the range between 300MHz and 700MHz.
for GHz Noise Suppression BLM18HG102SN1 (1000Ω at 100MHz)		In addition to the effectiveness of current BLM, BLM18HG suppresses noise in the range beyond 700MHz.

Comparison between BLM18HG102SN1 and BLM18AG102SN1 (CURRENT ITEM)

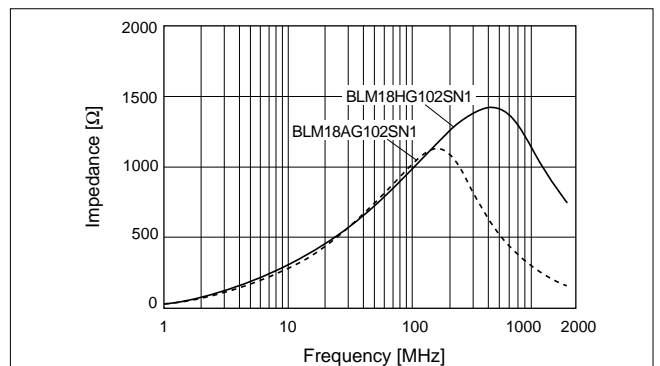

On-Board Type (DC) EMI Suppression Filters (EMIFIL®)



Chip Ferrite Beads Arrays BLA2AA/BLA2AB/BLA31A/BLA31B Series

1

BLA2AA/BLA2AB Series

■ Features

1. BLA2AA/2AB series has 4 circuits in 2.0x1.0mm body with 0.5mm pitch.
2. Provides attenuation across a broad frequency range. Two types of impedance characteristics are available; one is for general signal line and the other is for high speed signal line.
3. Original inner electrode structure enables extra low crosstalk.
4. The nickel barrier structure of the external electrodes provides excellent solder heat resistance.

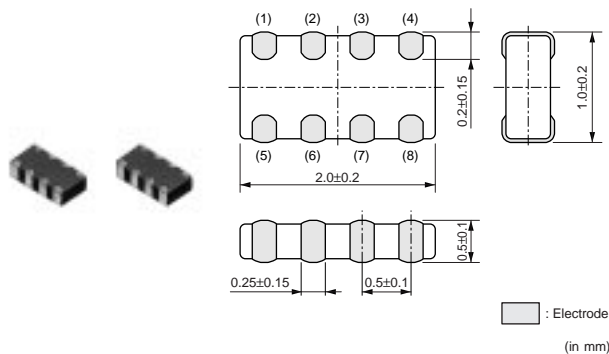

■ Applications

Notebook size PC, PDA and other compact size digital equipment

Part Number	Impedance (at 100MHz, 20 degree C) (ohm)	Rated Current (mA)	DC Resistance (max.) (ohm)	Operating Temperature Range (°C)
BLA2AAG121SN4	120 ±25%	100	0.50	-55 to 125
BLA2AAG221SN4	220 ±25%	50	0.70	-55 to 125
BLA2AAG601SN4	600 ±25%	50	1.10	-55 to 125
BLA2AAG102SN4	1000 ±25%	50	1.30	-55 to 125
BLA2ABB100SN4	10 ±25%	200	0.1	-55 to 125
BLA2ABB220SN4	22 ±25%	200	0.2	-55 to 125
BLA2ABB470SN4	47 ±25%	200	0.35	-55 to 125
BLA2ABB121SN4	120 ±25%	50	0.60	-55 to 125
BLA2ABB221SN4	220 ±25%	50	0.90	-55 to 125
BLA2ABD471SN4	470 ±25%	100	0.65	-55 to 125
BLA2ABD601SN4	600 ±25%	100	0.80	-55 to 125
BLA2ABD102SN4	1000 ±25%	50	1.00	-55 to 125

Number of Circuits : 4

■ Equivalent Circuit

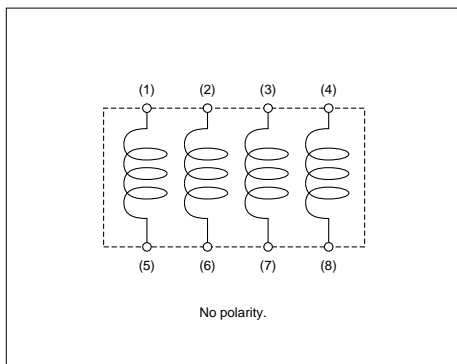

■ Impedance-Frequency (Typical)

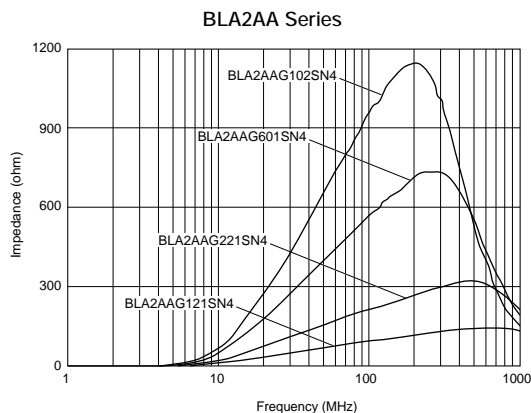

Continued on the following page. ↗

Continued from the preceding page.

■ Impedance-Frequency (Typical)

BLA2ABB Series

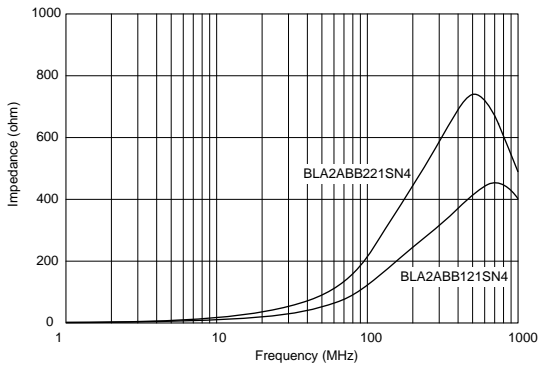

BLA2ABD Series

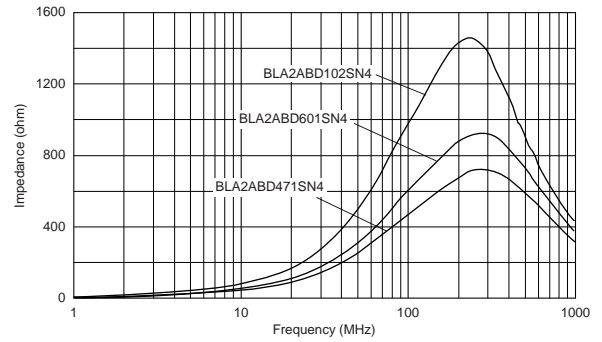

■ Impedance-Frequency Characteristics

BLA2AAG121SN4

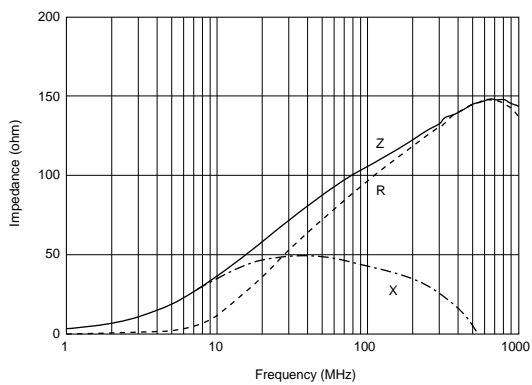

BLA2AAG221SN4

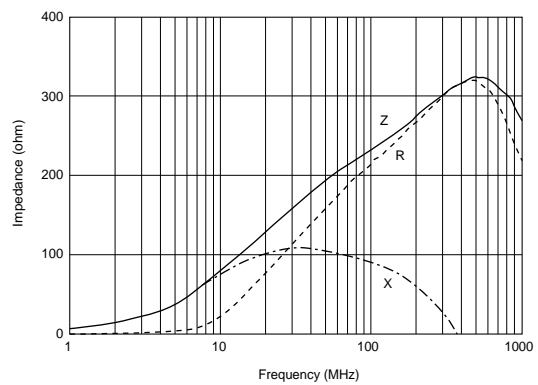

BLA2AAG601SN4

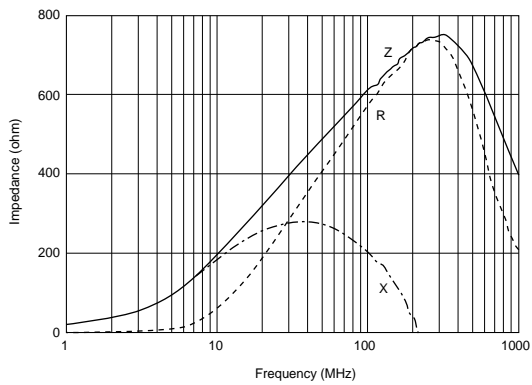

BLA2AAG102SN4

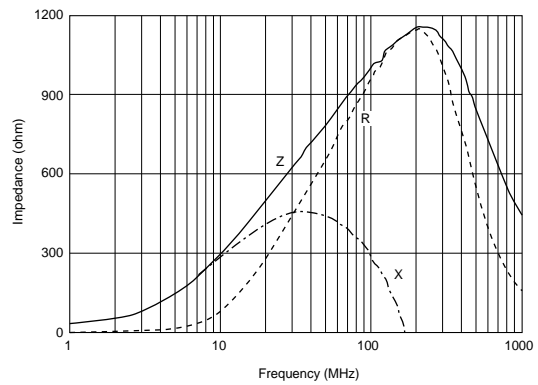

BLA2ABB100SN4

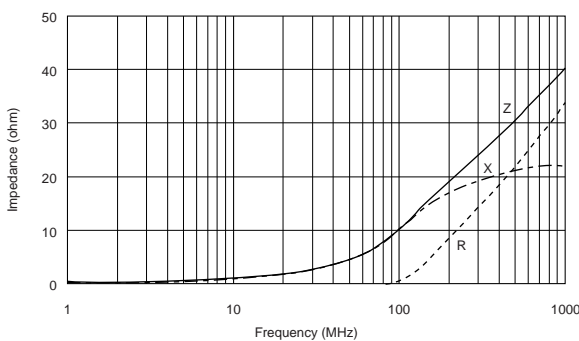

BLA2ABB220SN4

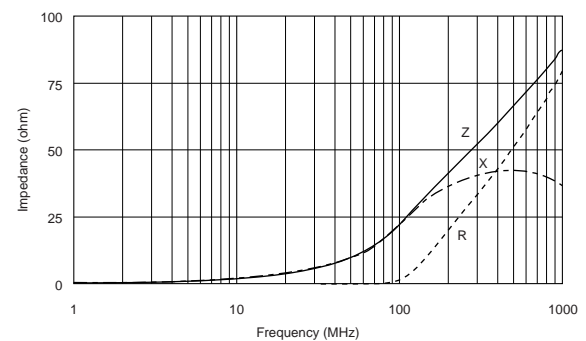

Continued on the following page. ↗

Continued from the preceding page.

Impedance-Frequency Characteristics

BLA2ABB470SN4

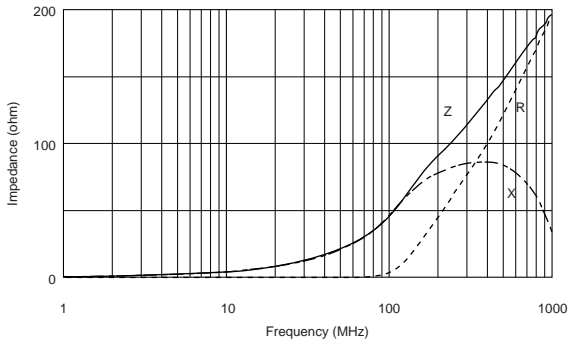

BLA2ABB121SN4

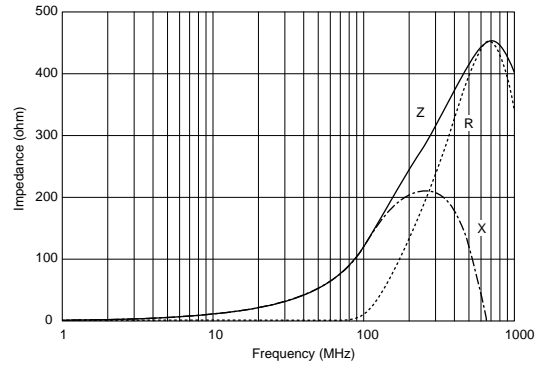

BLA2ABB221SN4

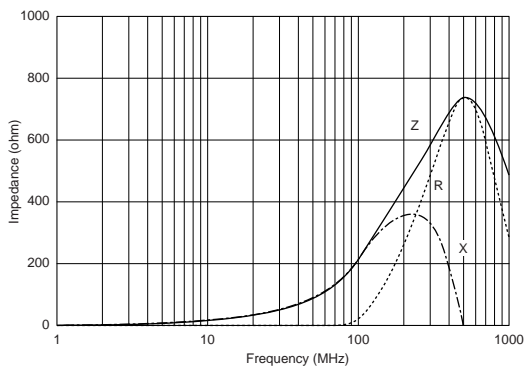

BLA2ABD471SN4

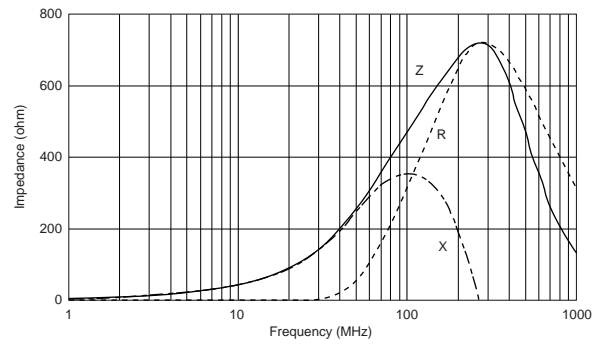

BLA2ABD601SN4

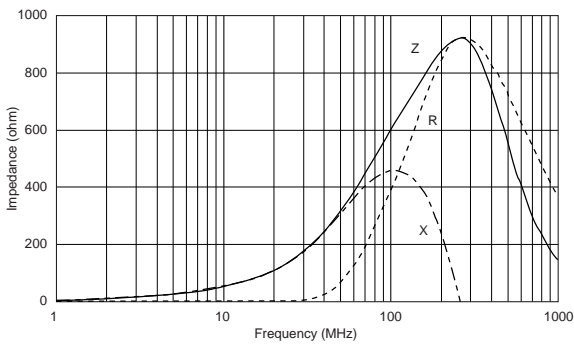

BLA2ABD102SN4

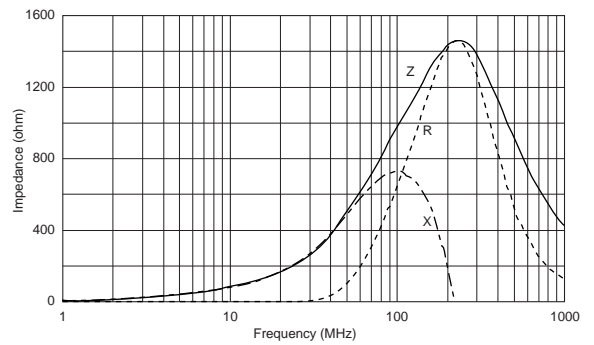

1

BLA31A/BLA31B Series

The miniaturization of electronic equipment requires high performance EMI filters which enable high density mounting. BLA31A/B series consists of 4 circuits of ferrite beads.

BLA31A/B is suitable for EMI suppression in smaller digital equipment.

■ Features

1. BLA31A/B has 4 circuits in 3.2x1.6mm body with 0.8mm pitch.
2. Provides attenuation across a broad frequency range.
Two types of impedance are available which meet general signal line and high speed signal line.
3. Original inner electrode structure enables extra low crosstalk.
4. The nickel barrier structure of the external electrodes provides excellent solder heat resistance. Both flow and reflow soldering methods can be employed.

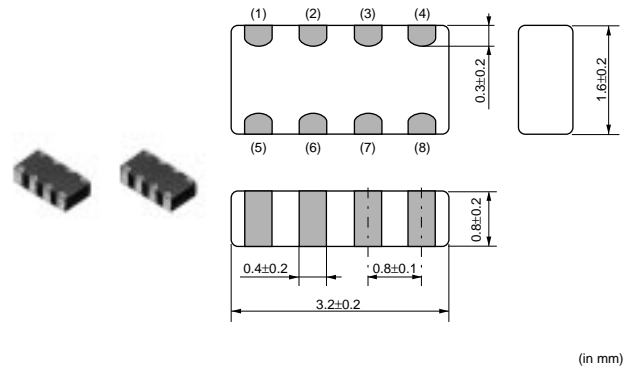

Part Number	Impedance (at 100MHz, 20 degree C) (ohm)	Rated Current (mA)	DC Resistance (max.) (ohm)	Operating Temperature Range (°C)
BLA31AG300SN4	30 ±25%	200	0.10	-55 to 125
BLA31AG600SN4	60 ±25%	200	0.15	-55 to 125
BLA31AG121SN4	120 ±25%	150	0.20	-55 to 125
BLA31AG221SN4	220 ±25%	150	0.25	-55 to 125
BLA31AG601SN4	600 ±25%	100	0.35	-55 to 125
BLA31AG102SN4	1000 ±25%	50	0.45	-55 to 125
BLA31BD121SN4	120 ±25%	150	0.30	-55 to 125
BLA31BD221SN4	220 ±25%	150	0.35	-55 to 125
BLA31BD471SN4	470 ±25%	100	0.40	-55 to 125
BLA31BD601SN4	600 ±25%	100	0.45	-55 to 125
BLA31BD102SN4	1000 ±25%	50	0.55	-55 to 125

Number of Circuits : 4

■ Equivalent Circuit

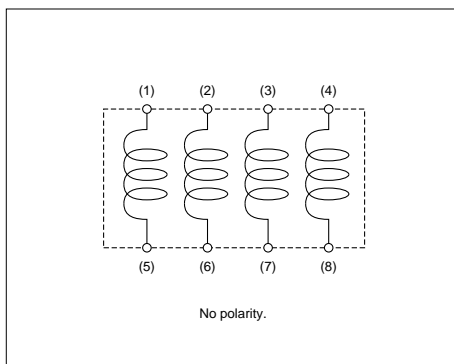

■ Impedance-Frequency (Typical)

BLA31A Series

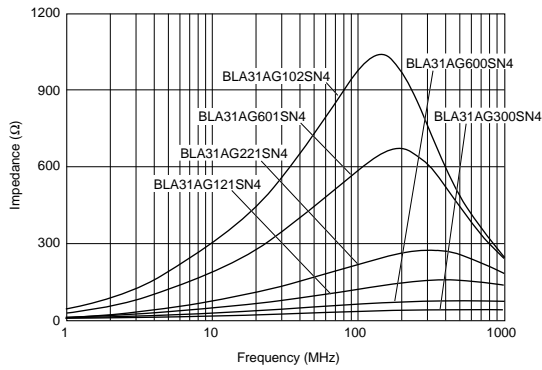

BLA31B Series

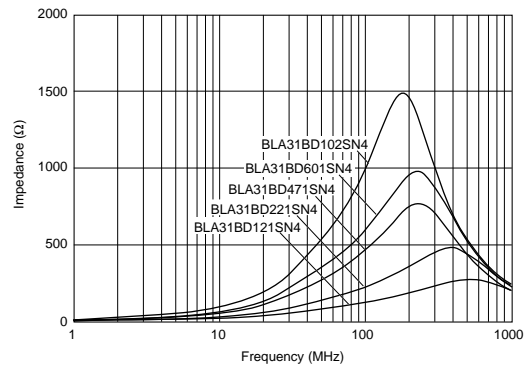

■ Impedance-Frequency Characteristics

BLA31AG300SN4

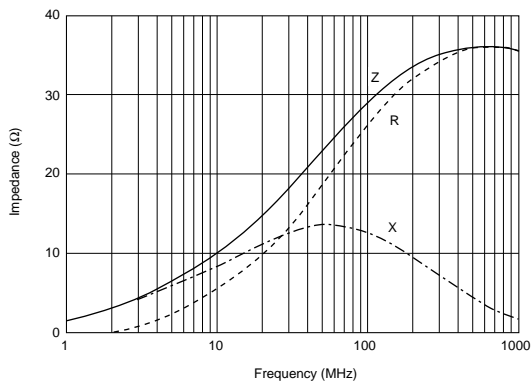

BLA31AG600SN4

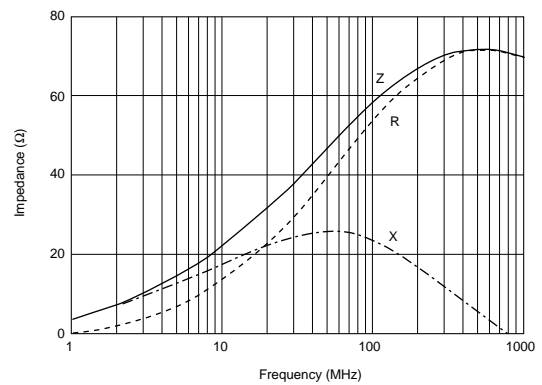

BLA31AG121SN4

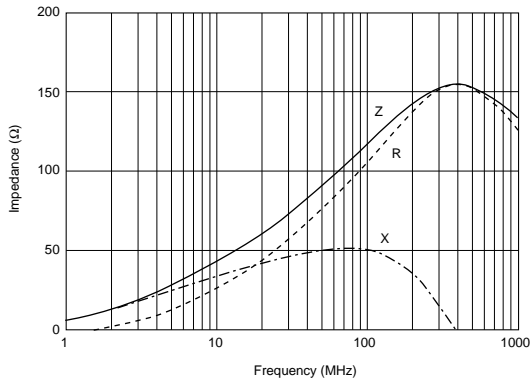

BLA31AG221SN4

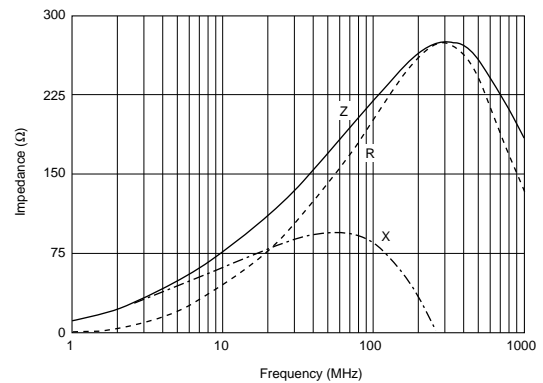

BLA31AG601SN4

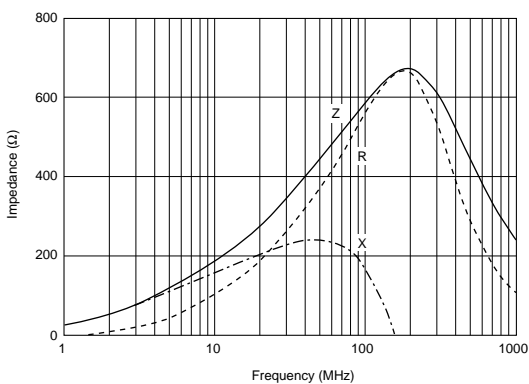

BLA31AG102SN4

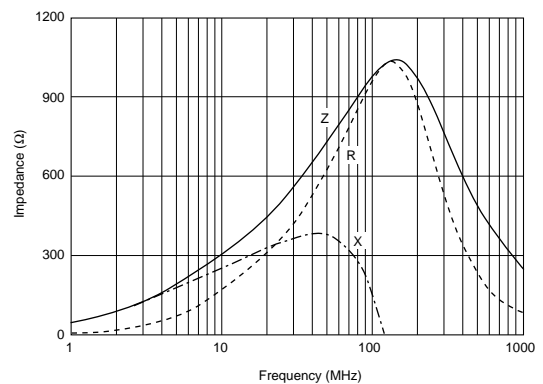

Continued on the following page. ↗

Continued from the preceding page.

Impedance-Frequency Characteristics

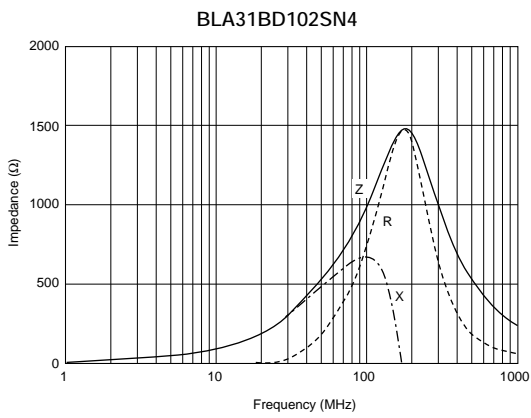
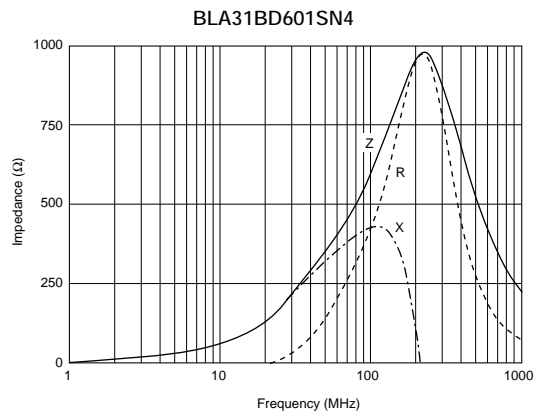
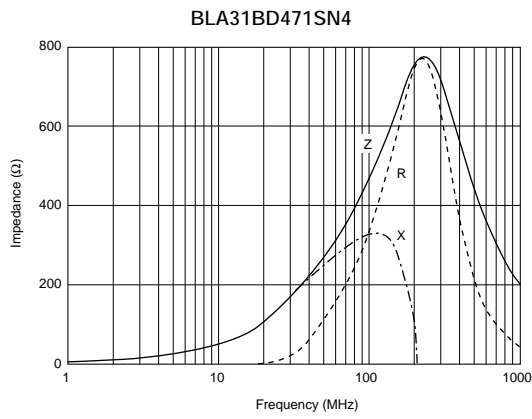
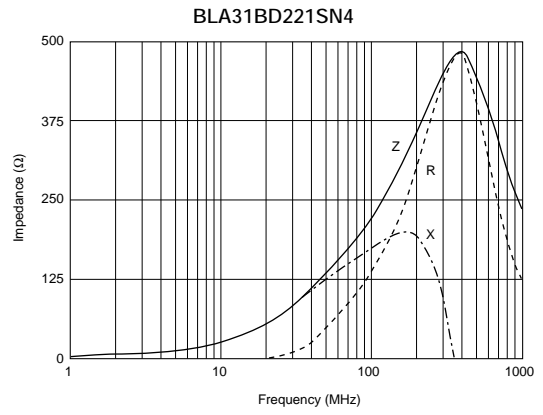
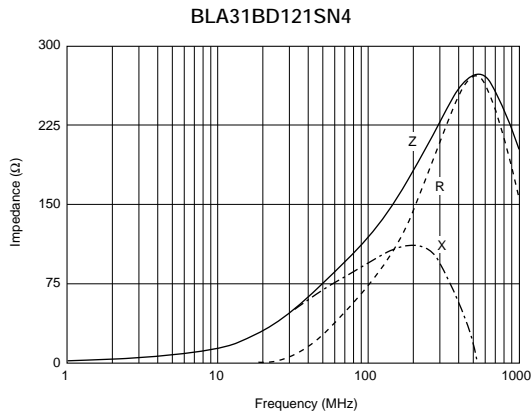

1

On-Board Type (DC) EMI Suppression Filters (EMIFIL[®])



Chip EMIFIL[®] Part Numbering

Chip EMIFIL[®] Capacitor Type

(Global Part Number) **NF** **M** **3D** **CC** **102** **R** **1H** **3** **L**
① ② ③ ④ ⑤ ⑥ ⑦ ⑧ ⑨

① Product ID

Product ID	
NF	Chip EMI Filters Capacitor Type

② Structure

Code	Structure
M	Capacitor Type

③ Dimensions (L×W)

Code	Dimensions (L×W)	EIA
18	1.6×0.8mm	0603
21	2.0×1.25mm	0805
3D	3.2×1.25mm	1206
41	4.5×1.6mm	1806

④ Features

Code	Features
CC	Capacitor Type for Signal Lines
PC	Capacitor Type for Large Current

⑤ Capacitance

Expressed by three figures. The unit is in pico-farad (pF). The first and second figures are significant digits, and the third figure expresses the number of zeros which follow the two figures.

⑨ Packaging

Code	Packaging	Series
L	Plastic Taping (ø180mm Reel)	NFM3D/NFM41
B	Bulk	All series
D	Paper Taping (ø180mm Reel)	NFM18/NFM21

⑥ Characteristics

Code	Capacitance Change
B	±10%
F	+30/-80%
R	±15%
U	-750 ±120ppm/°C
S	+350 to -1000ppm/°C

⑦ Rated Voltage

Code	Rated Voltage
0J	6.3V
1A	10V
1C	16V
1E	25V
1H	50V
2A	100V

⑧ Electrode/Others

Code	Electrode
3	Sn Plating

Chip EMIFIL® Capacitor Array Type

(Global Part Number)

NF	A	31	CC	101	S	1E	4	B
①	②	③	④	⑤	⑥	⑦	⑧	⑨

① Product ID

Product ID	
NF	Chip EMI Filters Capacitor Type

② Structure

Code	Structure
A	Array Type

③ Dimensions (L×W)

Code	Dimensions (L×W)
31	3.2×1.6mm

④ Features

Code	Features
CC	Capacitor Type for Signal Lines

⑤ Capacitance

Expressed by three figures. The unit is in pico-farad (pF). The first and second figures are significant digits, and the third figure expresses the number of zeros which follow the two figures.

⑥ Characteristics

Code	Capacitance Change
R	±15%
S	+350 to -1000ppm/°C

⑦ Rated Voltage

Code	Rated Voltage
1C	16V
1E	25V

⑧ Number of Circuits

Code	Number of Circuits
4	4 Circuits

⑨ Packaging

Code	Packaging
B	Bulk
D	Paper Taping (ø180mm Reel)

Chip EMIFIL® RC Combined Type

(Global Part Number)

NF	R	21	GD	470	470	2	L
①	②	③	④	⑤	⑥	⑦	⑧

① Product ID

Product ID	
NF	EMIFIL®

② Structure

Code	Structure
R	RC Combined Type

③ Dimensions (L×W)

Code	Dimensions (L×W)	EIA
21	2.0×1.25mm	0805

④ Features

Code	Features
GD	RC Combined Type for Signal Lines

⑤ Capacitance

Expressed by three figures. The unit is in pico-farad (pF). The first and second figures are significant digits, and the third figure expresses the number of zeros which follow the two figures.

⑥ Resistance

Expressed by three figures. The unit is in ohm (Ω). The first and second figures are significant digits, and the third figure expresses the number of zeros which follow the two figures.

⑦ Electrode/Others

Code	Electrode
2	Sn Plating

⑧ Packaging

Code	Packaging
L	Plastic Taping (ø180mm Reel)
B	Bulk

Chip EMIFIL® RC Combined Array Type

(Global Part Number)

NF	A	31	GD	100	101	4	D
①	②	③	④	⑤	⑥	⑦	⑧

① Product ID

Product ID	
NF	EMIFIL®

② Structure

Code	Structure
A	Array Type

③ Dimensions (L×W)

Code	Dimensions (L×W)
31	3.2×1.6mm

④ Features

Code	Features
GD	RC Combined Type for Signal Lines

⑤ Capacitance

Expressed by three figures. The unit is in pico-farad (pF). The first and second figures are significant digits, and the third figure expresses the number of zeros which follow the two figures. If there is a decimal point, it is expressed by the capital letter "R". In this case, all figures are significant digits.

⑥ Resistance

Expressed by three figures. The unit is in ohm (Ω). The first and second figures are significant digits, and the third figure expresses the number of zeros which follow the two figures. If there is a decimal point, it is expressed by the capital letter "R". In this case, all figures are significant digits.

⑦ Number of Circuits

Code	Number of Circuits
4	4 Circuits

⑧ Packaging

Code	Packaging
B	Bulk
D	Paper Taping (ø180mm Reel)

Chip EMIFIL® LC Combined Type

(Global Part Number)

NF	W	31	SP	206	X	1E	4	L
①	②	③	④	⑤	⑥	⑦	⑧	⑨

① Product ID

Product ID	
NF	Chip EMI Filters LC Combined Type

② Structure

Code	Structure
L	Monolithic, LC Combined Type
W	Winding, LC Combined Type
E	Block, LC Combined Type

③ Dimensions (L×W)

Code	Dimensions (L×W)	EIA
18	1.6×0.8mm	0603
21	2.0×1.25mm	0805
31	3.2×1.6mm	1206
61	6.8×1.6mm	2606

④ Features

Code	Features
SP	π Circuit for Signal Lines
ST	T Circuit for Signal Lines
PT	T Circuit for Large Current
HT	T Circuit for Heavy-duty

⑤ Cut-off Frequency (NFL/NFW Series)

Expressed by three figures. The unit is in hertz (Hz). The first and second figures are significant digits, and the third figure expresses the number of zeros which follow the two figures.

⑥ Capacitance (NFE Series)

Expressed by three figures. The unit is in pico-farad (pF). The first and second figures are significant digits, and the third figure expresses the number of zeros which follow the two figures.

⑨ Packaging

Code	Packaging	Series
K	Plastic Taping (ø330mm Reel)	NFW31/NFE
L	Plastic Taping (ø180mm Reel)	NFW31/NFE
B	Bulk	NFL18/NFL21/NFE
D	Paper Taping (ø180mm Reel)	NFL18/NFL21

⑥ Characteristics (NFL/NFW Series)

Code	Characteristics
X	Cut off Frequency

⑥ Characteristics (NFE Series)

Code	Capacitance Change
B	±10%
C	±20%, ±22%
D	+20/-30%, +22/-33%
E	+20/-55%, +22/-56%
F	+30/-80%, +22/-82%
R	±15%
U	-750 ±120ppm/ °C
Z	Other

⑦ Rated Voltage

Code	Rated Voltage
1A	10V
1C	16V
1E	25V
1H	50V
2A	100V

⑧ Electrode

Expressed by a figure.

Ex.)

Code	Electrode	Series
3	Sn Plating	NFL
4	Solder Coating	NFW
9	Others	NFE

On-Board Type (DC) EMI Suppression Filters (EMIFIL[®])



Chip EMIFIL[®] Capacitor Type NFM18C/NFM21C/NFM3DC/NFM41C Series

NFM18C Series

The NFM18CC series is a 1.6x0.8mm EMI suppression filter for signal lines which has a 3-terminal structure using Murata's multilayer technology.

■ Features

1. Ultra small size in 1.6x0.8x0.6mm enable high density mounting.
2. 3-terminal structure with low residual inductance (ESL)* characteristics achieves large insertion loss characteristics even in high frequency area.
3. The NFM18cc series covers capacitance range from 22 to 22000pF.

■ Applications

1. EMI suppression of circuit for insertion loss in quantity.
2. Noise suppression up to GHz.

* Not exceeding one-tenth of monolithic ceramic capacitors (2-terminal).

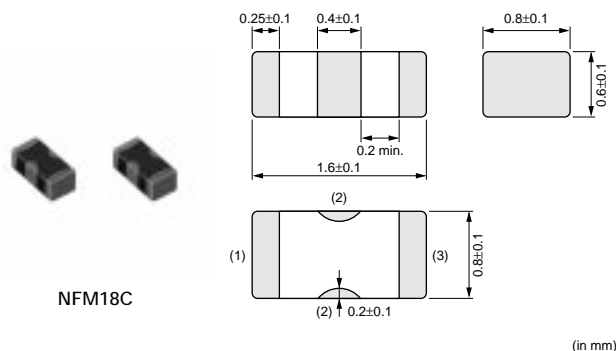

(in mm)

Part Number	Capacitance (pF)	Rated Voltage (Vdc)	Rated Current (mA)	Insulation Resistance (M ohm)	Operating Temperature Range (°C)
NFM18CC220U1C3	22 +20%, -20%	16	300	1000 min.	-55 to 125
NFM18CC470U1C3	47 +20%, -20%	16	300	1000 min.	-55 to 125
NFM18CC101R1C3	100 +20%, -20%	16	300	1000 min.	-55 to 125
NFM18CC221R1C3	220 +20%, -20%	16	300	1000 min.	-55 to 125
NFM18CC471R1C3	470 +20%, -20%	16	300	1000 min.	-55 to 125
NFM18CC102R1C3	1000 +20%, -20%	16	300	1000 min.	-55 to 125
NFM18CC222R1C3	2200 +20%, -20%	16	300	1000 min.	-55 to 125
NFM18CC223R1C3	22000 +20%, -20%	16	1000	1000 min.	-55 to 125

■ Equivalent Circuit

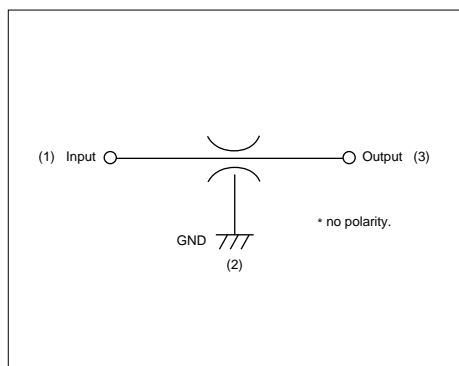

■ Insertion Loss Characteristics (Typical)

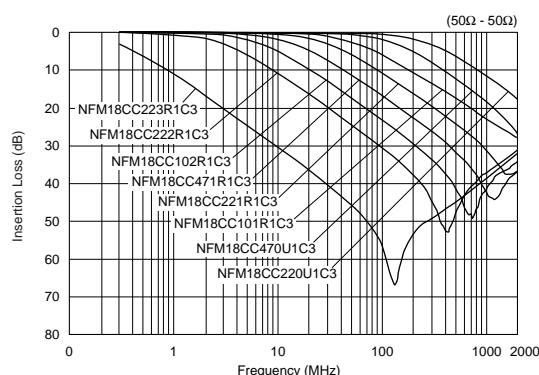

NFM21C Series

The chip "EMIFIL" NFM21C series is a chip type 3-terminal EMI suppression filter. It can reduce residual inductance to an extremely low level making it excellent for noise suppression at high frequencies.

■ Features

1. Small and low profile of 2.0x1.25x0.85mm (NFM21C) enables high density mounting.
2. 3-terminal structure enables high performance in high frequency range.
3. Uses original electrode structure which realizes excellent solderability.
4. An electrostatic capacitance range of 22 to 22000pF enables suppression of noise at specific frequencies.

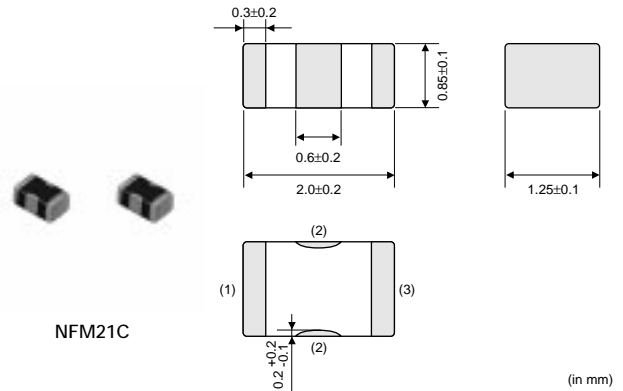

■ Applications

1. PCs and peripherals which emit high amount of noise
2. Compact size equipment such as PDA, PC card and mobile telecommunications equipment
3. Severe EMI suppression and high impedance circuits such as digital circuits

Part Number	Capacitance (pF)	Rated Voltage (Vdc)	Rated Current (mA)	Insulation Resistance (M ohm)	Operating Temperature Range (°C)
NFM21CC220U1H3	22 +20%, -20%	50	300	1000 min.	-55 to 125
NFM21CC470U1H3	47 +20%, -20%	50	300	1000 min.	-55 to 125
NFM21CC101U1H3	100 +20%, -20%	50	300	1000 min.	-55 to 125
NFM21CC221R1H3	220 +20%, -20%	50	300	1000 min.	-55 to 125
NFM21CC471R1H3	470 +20%, -20%	50	300	1000 min.	-55 to 125
NFM21CC102R1H3	1000 +20%, -20%	50	300	1000 min.	-55 to 125
NFM21CC222R1H3	2200 +20%, -20%	50	300	1000 min.	-55 to 125
NFM21CC223R1H3	22000 +20%, -20%	50	2000	1000 min.	-55 to 125

■ Equivalent Circuit

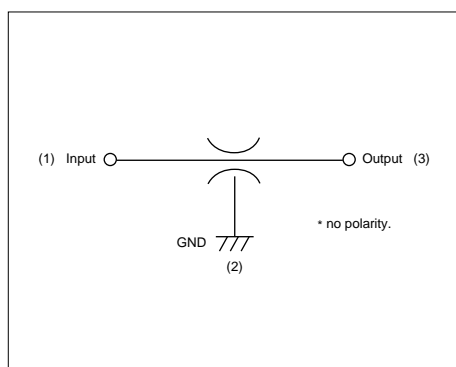

■ Insertion Loss Characteristics (Typical)

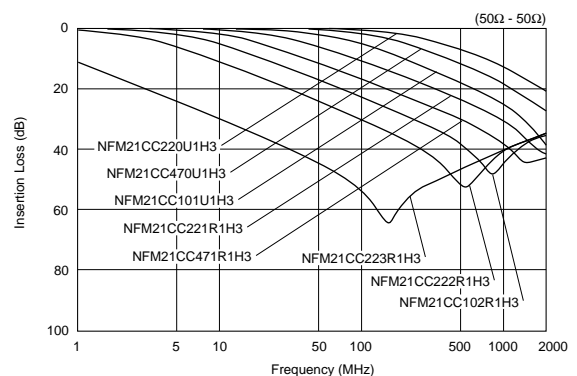

NFM3DC Series

The chip "EMIFIL" NFM3DC series is a chip type 3-terminal EMI suppression filter. It can reduce residual inductance to an extremely low level making it excellent for noise suppression at high frequencies.

■ Feature

An electrostatic capacitance range of 22 to 22,000pF enables suppression of noise at specific frequencies.

■ Application

1. High noise radiation and high impedance circuits such as digital circuits

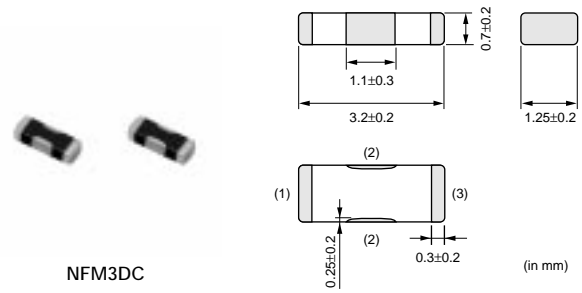

2

Part Number	Capacitance (pF)	Rated Voltage (Vdc)	Rated Current (mA)	Insulation Resistance (M ohm)	Operating Temperature Range (°C)
NFM3DCC220U1H3	22 +50%, -20%	50	300	1000 min.	-55 to 125
NFM3DCC470U1H3	47 +50%, -20%	50	300	1000 min.	-55 to 125
NFM3DCC101U1H3	100 +50%, -20%	50	300	1000 min.	-55 to 125
NFM3DCC221R1H3	220 +50%, -20%	50	300	1000 min.	-55 to 125
NFM3DCC471R1H3	470 +50%, -20%	50	300	1000 min.	-55 to 125
NFM3DCC102R1H3	1000 +50%, -20%	50	300	1000 min.	-55 to 125
NFM3DCC222R1H3	2200 +50%, -20%	50	300	1000 min.	-55 to 125
NFM3DCC223R1H3	22000 +50%, -20%	50	300	1000 min.	-55 to 125

■ Equivalent Circuit

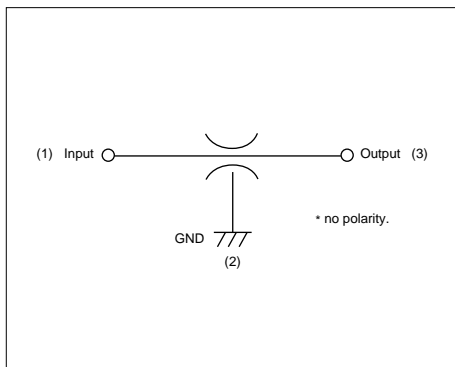

■ Insertion Loss Characteristics (Typical)

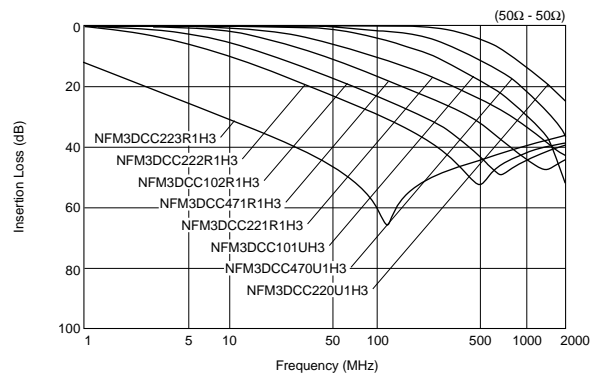

NFM41C Series

The chip "EMIFIL" NFM41C series is a chip type 3-terminal EMI suppression filter. It can reduce residual inductance to an extremely low level making it excellent for noise suppression at high frequencies.

■ Features

An electrostatic capacitance range of 22 to 22,000pF enables suppression of noise at specific frequencies.

■ Applications

1. High noise radiation and high impedance circuits such as digital circuits

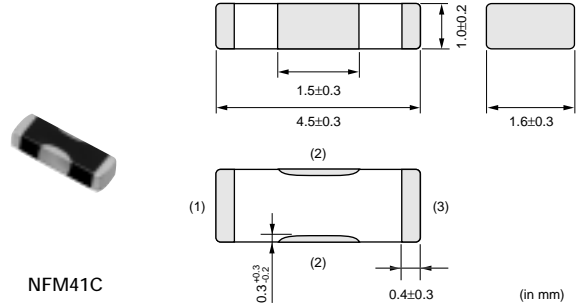

Part Number	Capacitance (pF)	Rated Voltage (Vdc)	Rated Current (mA)	Insulation Resistance (M ohm)	Operating Temperature Range (°C)
NFM41CC220U2A3	22 +50%, -20%	100	300	10000 min.	-55 to 125
NFM41CC470U2A3	47 +50%, -20%	100	300	10000 min.	-55 to 125
NFM41CC101U2A3	100 +50%, -20%	100	300	10000 min.	-55 to 125
NFM41CC221U2A3	220 +50%, -20%	100	300	10000 min.	-55 to 125
NFM41CC471R2A3	470 +50%, -20%	100	300	10000 min.	-55 to 125
NFM41CC102R2A3	1000 +50%, -20%	100	300	10000 min.	-55 to 125
NFM41CC222R2A3	2200 +50%, -20%	100	300	10000 min.	-55 to 125
NFM41CC223R2A3	22000 +50%, -20%	100	300	10000 min.	-55 to 125

■ Equivalent Circuit

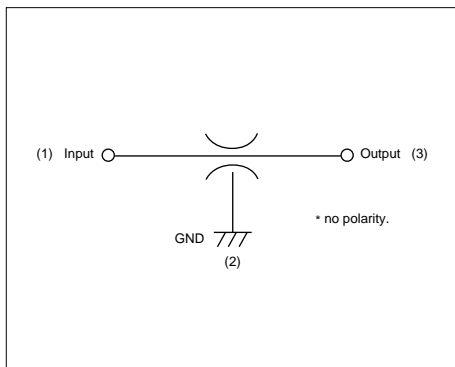

■ Insertion Loss Characteristics (Typical)

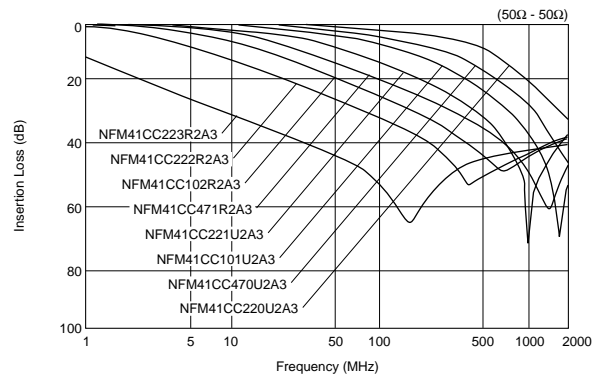

On-Board Type (DC) EMI Suppression Filters (EMIFIL[®])



Chip EMIFIL[®] Capacitor Array Type NFA31C Series

The NFA31C series is a chip EMI suppression filter for surface mount applications by using Murata's ceramic processing technology and filter design technology. The series is well suited for EMI suppression in digital I/O lines of varied electronic equipment such as notebook size PCs.

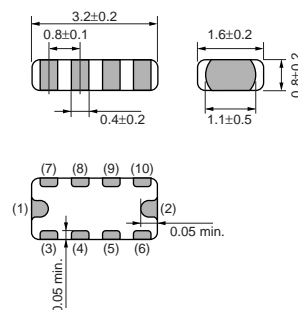

(in mm)

■ Features

1. High density mounting can be realized because of 4 circuits in one package with 0.8mm pitch.
2. Suitable for high frequency noise suppression because of low residual inductance of 3-terminal structure.
3. Excellent EMI suppression can be realized because of 2-terminal simple GNDs for 4 circuits.
4. 20 to 22,000pF lineups can be used depending on noise frequency.

■ Applications

1. Personal computers and peripherals
2. Telephones, PPCs, communications equipment
3. Digital TVs, VCRs

Part Number	Capacitance (pF)	Rated Voltage (Vdc)	Rated Current (mA)	Insulation Resistance (M ohm)	Operating Temperature Range (°C)
NFA31CC220S1E4	22 +20%, -20%	25	200	1000 min.	-40 to 85
NFA31CC470S1E4	47 +20%, -20%	25	200	1000 min.	-40 to 85
NFA31CC101S1E4	100 +20%, -20%	25	200	1000 min.	-40 to 85
NFA31CC221S1E4	220 +20%, -20%	25	200	1000 min.	-40 to 85
NFA31CC471R1E4	470 +20%, -20%	25	200	1000 min.	-40 to 85
NFA31CC102R1E4	1000 +20%, -20%	25	200	1000 min.	-40 to 85
NFA31CC222R1E4	2200 +20%, -20%	25	200	1000 min.	-40 to 85
NFA31CC223R1C4	22000 +20%, -20%	16	200	1000 min.	-40 to 85

Number of Circuits : 4

■ Equivalent Circuit

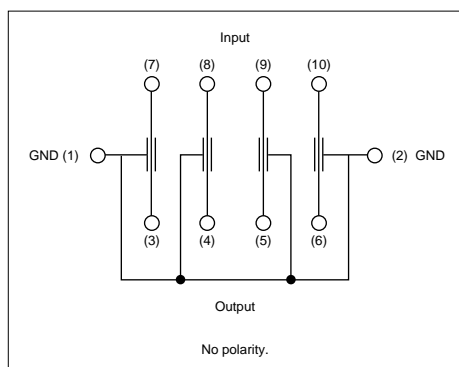

■ Insertion Loss Characteristics (Typical)

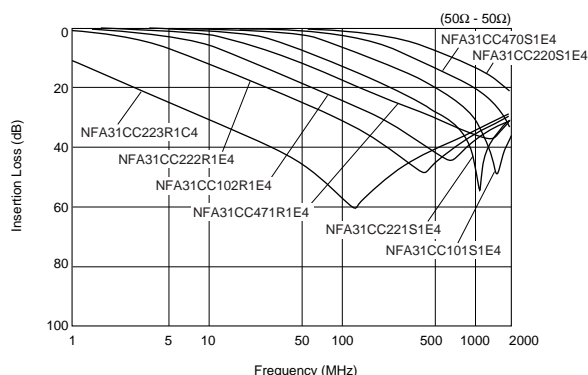

On-Board Type (DC) EMI Suppression Filters (EMIFIL[®])



Chip EMIFIL[®] RC Combined Type NFR21G Series

The NFR21G series comprises high performance EMI suppression filters which can suppress distortion of waveform. Various items may be used, considering circuit impedance and noise condition.

■ Features

1. Murata's original inner design realizes small and low profile of 2.0x1.25x0.5mm.
2. Distributed constant circuit realizes smooth change of impedance which prevents reflection of signal and distortion of wave shape.
3. The NFR21G series is effective in a line where ground is not stable, because the resistance element in the filter absorbs noise and returns it to ground line.
4. The NFR21G series has no polarity so it can be used in dual direction transport lines.
5. The NFR21G series has various lineups of resistance (22 to 100ohm) and capacitance (10 to 100pF).

■ Applications

Interface lines and clock lines where signals are tend to be distorted

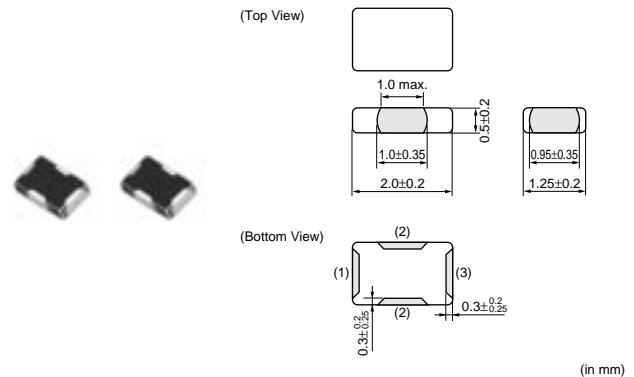

2

Part Number	Capacitance (pF)	Resistance (ohm)	Rated Current (mA)	Rated Voltage (Vdc)	Insulation Resistance (M ohm)	Operating Temperature Range (°C)
NFR21GD1002202	10 +20%,-20%	22 +30%,-30%	50	50	1000 min.	-40 to 85
NFR21GD1004702	10 +20%,-20%	47 +30%,-30%	35	50	1000 min.	-40 to 85
NFR21GD4702202	47 +20%,-20%	22 +30%,-30%	50	50	1000 min.	-40 to 85
NFR21GD4704702	47 +20%,-20%	47 +30%,-30%	35	50	1000 min.	-40 to 85
NFR21GD4706802	47 +20%,-20%	68 +30%,-30%	30	50	1000 min.	-40 to 85
NFR21GD4701012	47 +20%,-20%	100 +30%,-30%	25	50	1000 min.	-40 to 85
NFR21GD1012202	100 +20%,-20%	22 +30%,-30%	50	50	1000 min.	-40 to 85
NFR21GD1014702	100 +20%,-20%	47 +30%,-30%	35	50	1000 min.	-40 to 85
NFR21GD1016802	100 +20%,-20%	68 +30%,-30%	30	50	1000 min.	-40 to 85
NFR21GD1011012	100 +20%,-20%	100 +30%,-30%	25	50	1000 min.	-40 to 85

Number of Circuits : 1

■ Equivalent Circuit

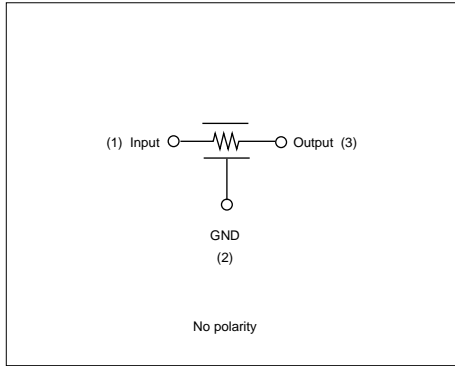

2

■ Insertion Loss Characteristics (Typical)

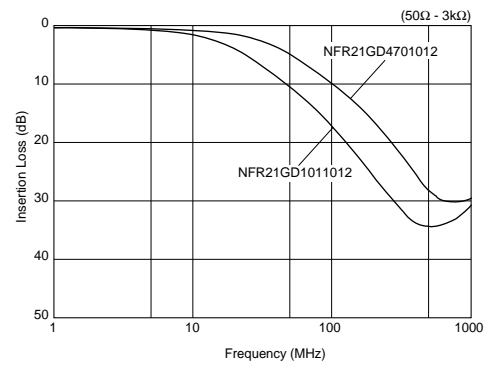
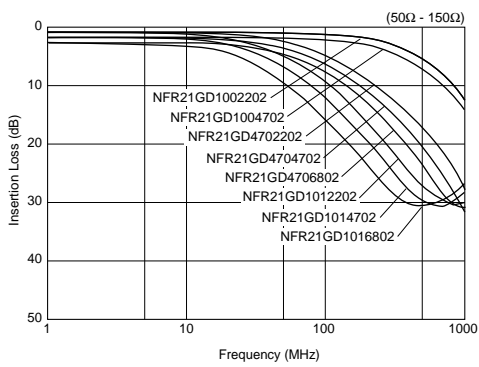

Noise Suppression Effect of NFR21G Series

■Effect of Noise Suppression by NFR21G

The NFR21G is effective even if ground line is not stable enough due to its distributed constant circuit structure.

[Testing Circuit]

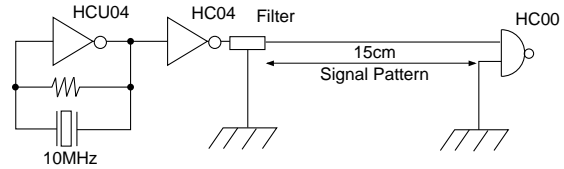

With Stable Ground Line

Type of Filter	EMI Suppression Effect	Description
Noise Level without Filter		
Filter Mounting Condition Standard Type Chip EMIFIL® (100pF)		The standard type chip EMIFIL® is effective on stable ground lines.
Filter Mounting Condition NFR21GD4701012		The NFR21G has some advantages to standard type EMIFIL® on stable ground lines.

With Poor Ground Line

Type of Filter	EMI Suppression Effect	Description
Noise Level without Filter		
Filter Mounting Condition Standard Type Chip EMIFIL® (100pF)		The standard type EMIFIL® loses efficiency on poor ground lines.
Filter Mounting Condition NFR21GD4701012		The NFR21G is effective even on poor ground lines because of its distributed constant circuit structure and unique system to limit rush current.

Noise Suppression Effect of NFR21G Series

Waveform Distortion Suppressing Function by NFR21G

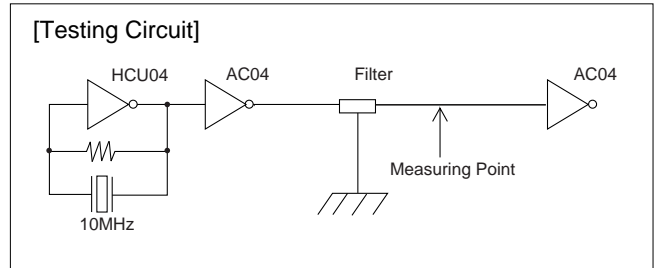

Type of Filter	EMI Suppression Effect	Description
Initial Waveform (no filter)	<p>Voltage Waveform</p> <p>↑ :1V/div → :20ns/div</p>	<p>Resonance between the internal capacitance of the IC and the inductance of the print pattern causes waveform overshooting and undershooting.</p>
When Ordinary Capacitor Filter is Used	<p>Voltage Waveform</p> <p>↑ :1V/div → :20ns/div</p>	<p>Ordinary capacitor filters have no waveform distortion suppressing capability, and they cannot suppress disturbances in the waveforms.</p>
NFR21G	<p>Voltage Waveform</p> <p>↑ :1V/div → :20ns/div</p>	<p>The waveform distortion suppressing function of the NFR21G minimizes disturbances of waveforms.</p>

2

On-Board Type (DC) EMI Suppression Filters (EMIFIL®)



Chip EMIFIL® RC Combined Array Type NFA31G Series

NFA31G series is a high performance EMI suppression filter array with a 4-circuit noise filter in 3.2x1.6mm size. NFA31G realizes high density mounting.

■ Features

1. NFA31G is a 4-circuit noise filter in 3.2x1.6mm size with 0.8mm pitch. High density mounting is available.
2. 3-terminal structure enables excellent high frequency performance.
3. Distributed constant circuit realizes smooth change of impedance which prevents reflection of signal and distortion of wave shape.
4. NFA31G series is effective in lines where ground is not stable, because the resistance element in the filter absorbs noise and returns it to ground line.

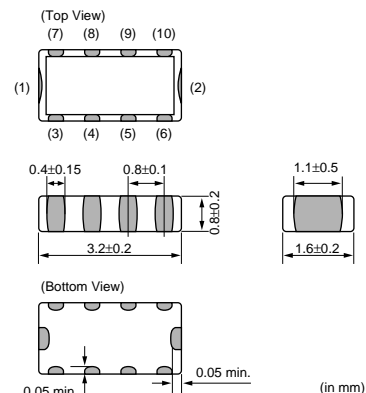

Part Number	Capacitance (pF)	Resistance (ohm)	Rated Current (mA)	Rated Voltage (Vdc)	Insulation Resistance (M ohm)	Operating Temperature Range (°C)
NFA31GD1006R84	10 +20%, -20%	6.8 +40%, -40%	50	6	1000 min	-40 to 85
NFA31GD1004704	10 +20%, -20%	47 +30%, -30%	20	6	1000 min	-40 to 85
NFA31GD1001014	10 +20%, -20%	100 +30%, -30%	15	6	1000 min	-40 to 85
NFA31GD4706R84	47 +20%, -20%	6.8 +40%, -40%	50	6	1000 min	-40 to 85
NFA31GD4704704	47 +20%, -20%	47 +30%, -30%	20	6	1000 min	-40 to 85
NFA31GD4701014	47 +20%, -20%	100 +30%, -30%	15	6	1000 min	-40 to 85
NFA31GD1016R84	100 +20%, -20%	6.8 +40%, -40%	50	6	1000 min	-40 to 85
NFA31GD1014704	100 +20%, -20%	47 +30%, -30%	20	6	1000 min	-40 to 85
NFA31GD1011014	100 +20%, -20%	100 +30%, -30%	15	6	1000 min	-40 to 85

Number of Circuits : 4

■ Equivalent Circuit

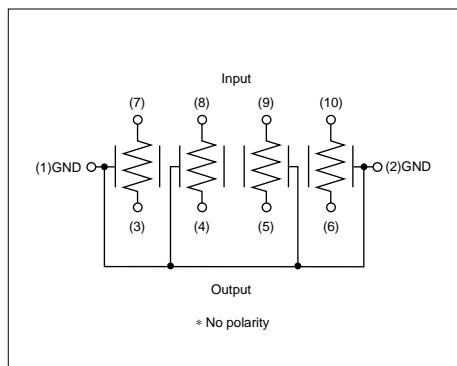

■ Insertion Loss Characteristics

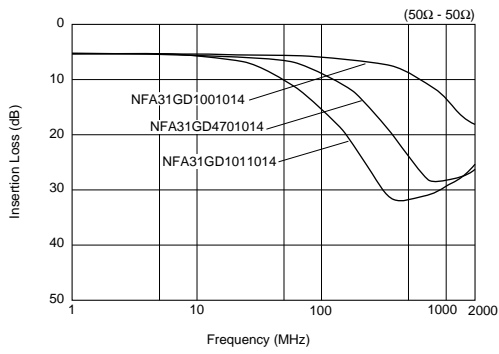
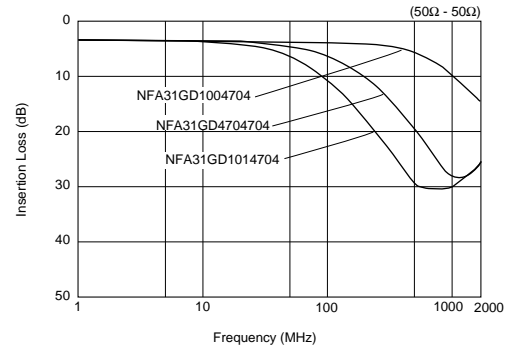
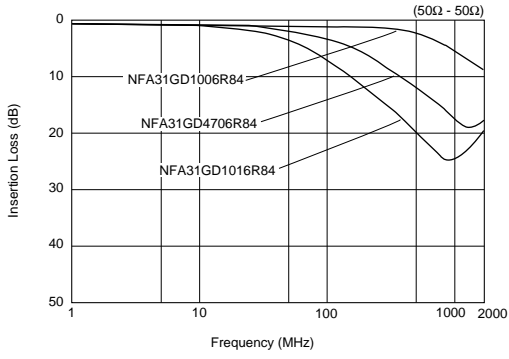

On-Board Type (DC) EMI Suppression Filters (EMIFIL®)



Chip EMIFIL® LC Combined Monolithic Type NFL18ST/NFL18SP/NFL21S Series

NFL18ST Series

This NFL18ST series is an EMI suppression filter for high speed signal lines, achieving T-type structure in 1.6x0.8mm size with Murata's multilayer technology.

■ Features

1. Ultra-small size in 1.6x0.8x0.8mm
2. Steep insertion loss characteristics realize excellent noise suppression and prevent distortion of signal waveform.
3. By minimizing stray capacitance of inductor, achieves high performance in noise suppression in high frequency range.
4. Five different values of cut-off frequency are available, ranging from 100MHz up to 500MHz.
5. No polarity using the same structure on all the side electrodes.

■ Applications

Noise suppression for video signal lines (RGB lines) and high speed clock lines

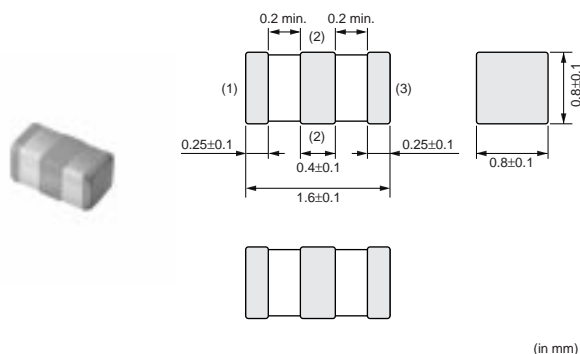

2

Part Number	Cut-off Frequency (MHz)	Capacitance (pF)	Inductance (nH)	Rated Voltage (Vdc)	Rated Current (mA)	Insulation Resistance (M ohm)	Operating Temperature Range (°C)
NFL18ST107X1C3	100	40 +20%, -20%	175 +20%, -20%	16	100	1000 min.	-55 to 125
NFL18ST157X1C3	150	32 +20%, -20%	140 +20%, -20%	16	100	1000 min.	-55 to 125
NFL18ST207X1C3	200	25 +20%, -20%	110 +20%, -20%	16	150	1000 min.	-55 to 125
NFL18ST307X1C3	300	18 +20%, -20%	62 +20%, -20%	16	200	1000 min.	-55 to 125
NFL18ST507X1C3	500	10 +20%, -20%	43 +20%, -20%	16	200	1000 min.	-55 to 125

Number of Circuits : 1

■ Equivalent Circuit

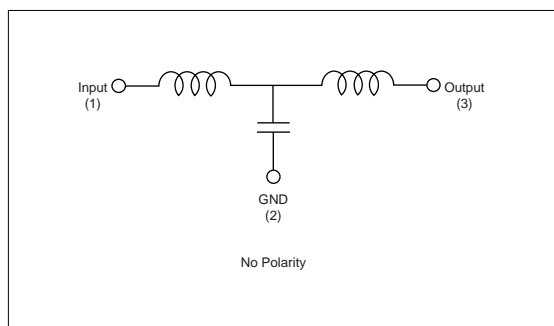

■ Insertion Loss Characteristics (Typical)

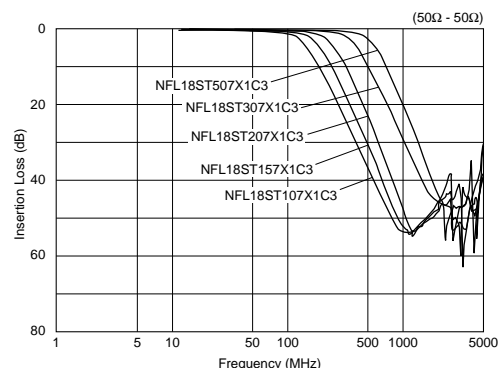

NFL18SP Series

The chip "EMIFIL" NFL18SP series is an EMI suppression filter for high speed signal lines, achieving pi-type structure in 0603 size with Murata's multilayer technology.

■ Features

1. Ultra-small size in 1.6x0.8x0.6 mm
2. Achieves high performance in noise suppression over wide frequency range.
3. Steep insertion loss characteristics realize excellent noise suppression and prevent distortion of signal waveform.
4. Line up 4 items of cut-off frequency range from 150 to 500MHz.

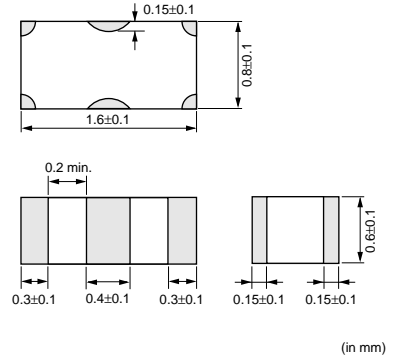

2

■ Applications

EMI suppression for digital signal line such as RGB and high speed clock lines

Part Number	Cut-off Frequency (MHz)	Capacitance (pF)	Inductance (nH)	Rated Voltage (Vdc)	Rated Current (mA)	Insulation Resistance (M ohm)	Operating Temperature Range (°C)
NFL18SP157X1A3	150	34 +20%, -20%	100 +20%, -20%	10	100	1000 min.	-55 to 125
NFL18SP207X1A3	200	24 +20%, -20%	80 +20%, -20%	10	100	1000 min.	-55 to 125
NFL18SP307X1A3	300	19 +20%, -20%	60 +20%, -20%	10	100	1000 min.	-55 to 125
NFL18SP507X1A3	500	11 +20%, -20%	38 +20%, -20%	10	100	1000 min.	-55 to 125

Number of Circuits : 1

■ Equivalent Circuit

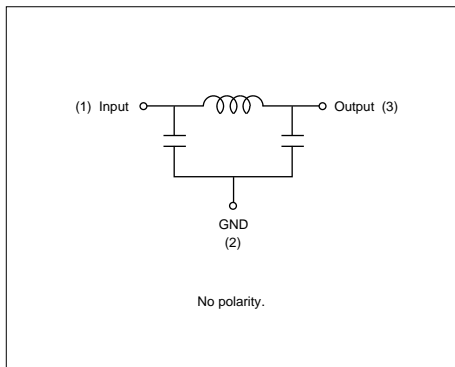

■ Insertion Loss Characteristics (Typical)

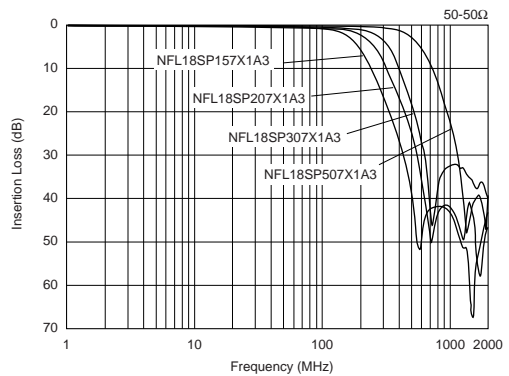

NFL21S Series

The chip "EMIFIL" NFL21S series is a high performance EMI suppression filter in 2.0x1.25mm size for high speed signal lines by using Murata's processing technology.

■ Features

1. Suppresses noise with few effects on the signal itself due to its steep filtering characteristics.
2. Murata's original internal structure design enables excellent noise suppression up to high frequencies.
3. Available in nine different values of cut-off frequency ranging from 20MHz up to 500MHz.

■ Applications

Suppression of high magnitude radiated noise generated by high speed digital circuits such as clock and RGB

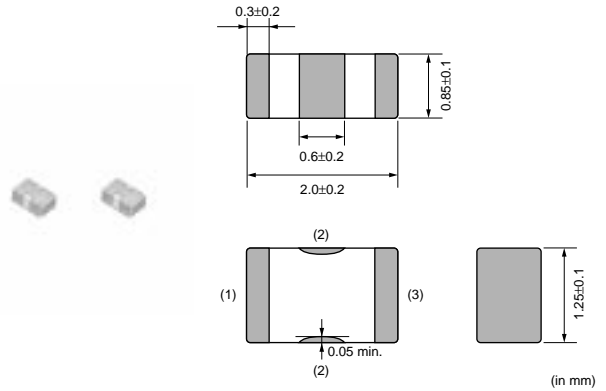

Part Number	Cut-off Frequency (MHz)	Capacitance (pF)	Inductance (nH)	Rated Voltage (Vdc)	Rated Current (mA)	Insulation Resistance (M ohm)	Operating Temperature Range (°C)
NFL21SP206X1C3	20	240 +20%, -20%	700 +20%, -20%	16	100	1000 min.	-55 to 125
NFL21SP506X1C3	50	84 +20%, -20%	305 +20%, -20%	16	150	1000 min.	-55 to 125
NFL21SP706X1C3	70	76 +20%, -20%	185 +20%, -20%	16	150	1000 min.	-55 to 125
NFL21SP107X1C3	100	44 +20%, -20%	135 +20%, -20%	16	200	1000 min.	-55 to 125
NFL21SP157X1C3	150	28 +20%, -20%	128 +20%, -20%	16	200	1000 min.	-55 to 125
NFL21SP207X1C3	200	22 +20%, -20%	72 +20%, -20%	16	250	1000 min.	-55 to 125
NFL21SP307X1C3	300	19 +10%, -10%	45 +10%, -10%	16	300	1000 min.	-55 to 125
NFL21SP407X1C3	400	16 +10%, -10%	34 +10%, -10%	16	300	1000 min.	-55 to 125
NFL21SP507X1C3	500	12 +10%, -10%	31 +10%, -10%	16	300	1000 min.	-55 to 125

Number of Circuits : 1

■ Equivalent Circuit

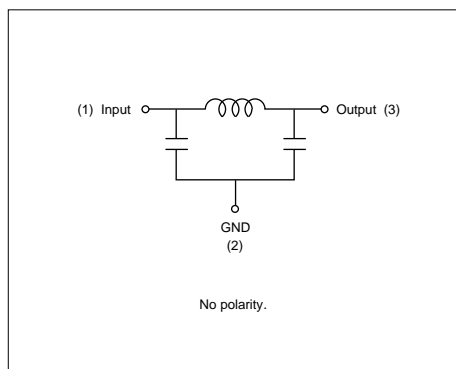

■ Insertion Loss Characteristics (Typical)

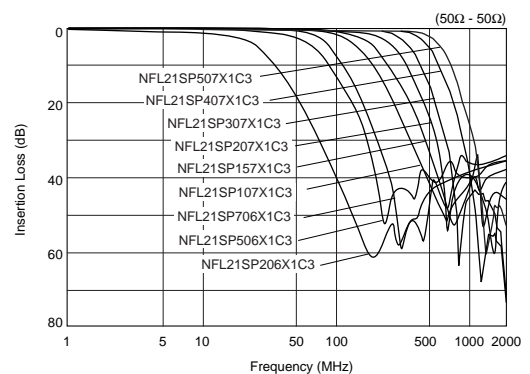

On-Board Type (DC) EMI Suppression Filters (EMIFIL[®])



Chip EMIFIL[®] LC Combined Winding Type NFW31S Series

The signal line chip EMI filter NFW31S series consists of high performance EMI suppression filters. They are designed for noise suppression in high speed signal digital circuits in which the signal harmonics are prone to becoming noise sources. These filters achieve a 100dB/dec. (typ.) damping characteristic with Murata's innovative circuit design. This makes these chips effective in applications where the signal and noise frequencies are close to each other.

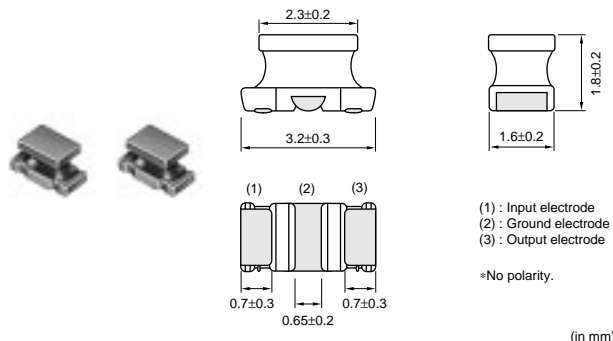

■ Features

1. Suppresses signal noise with little or no attenuation of the signal itself.
2. Murata's original internal structure design enables excellent noise suppression up to high frequencies (40dB at 1GHz typ.).
3. The NFW31S series is available in six different values of cut-off frequency ranging from 10MHz up to 500MHz.

Part Number	Nominal Cut-off Freq. (MHz)	Attenuation at 10MHz (dB)	Attenuation at 20MHz (dB)	Attenuation at 50MHz (dB)	Attenuation at 100MHz (dB)	Attenuation at 150MHz (dB)	Attenuation at 200MHz (dB)	Attenuation at 300MHz (dB)	Attenuation at 400MHz (dB)	Attenuation at 500MHz (dB)	Attenuation at 1000MHz (dB)
NFW31SP106X1E4	10	6 max.	5 min.	25 min.	25 min.	-	25 min.	-	-	30 min.	30 min.
NFW31SP206X1E4	20	-	6 max.	5 min.	25 min.	-	25 min.	-	-	30 min.	30 min.
NFW31SP506X1E4	50	-	-	6 max.	10 min.	-	30 min.	-	-	30 min.	30 min.
NFW31SP107X1E4	100	-	-	-	6 max.	-	5 min.	-	-	20 min.	30 min.
NFW31SP157X1E4	150	-	-	-	-	6 max.	-	10 min.	20 min.	30 min.	30 min.
NFW31SP207X1E4	200	-	-	-	-	-	6 max.	-	-	10 min.	30 min.
NFW31SP307X1E4	300	-	-	-	-	-	-	6 max.	-	5 min.	15 min.
NFW31SP407X1E4	400	-	-	-	-	-	-	-	6 max.	-	10 min.
NFW31SP507X1E4	500	-	-	-	-	-	-	-	-	6 max.	10 min.

Rated Current : 200mA Rated Voltage : 25Vdc Operating Temperature Range : -40°C to 85°C

■ Equivalent Circuit

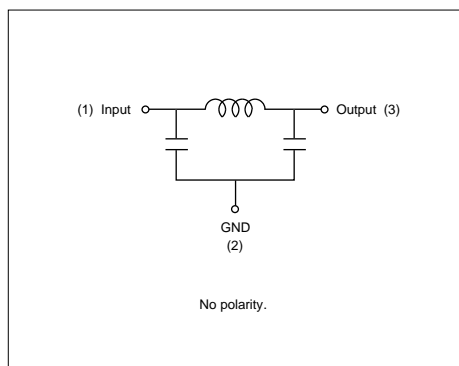

■ Insertion Loss Characteristics (Typical)

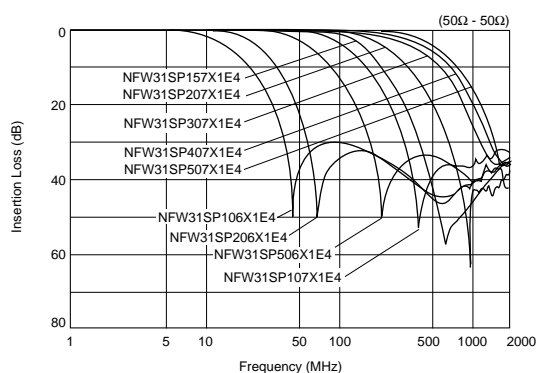

Noise Suppression Effect of NFW31S Series

Example of EMI Suppression in an Actual Circuit

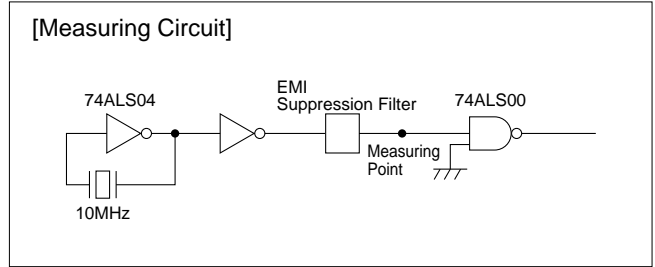

Type of Filter	Signal Wave Form (20ns/div, 1V/div)	EMI Suppression Effect	Description
Signal Waveform and Noise Spectrum before Filter Mounting	 Signal Waveform (20ns/div, 1V/div)	 Noise Spectrum (10:1 Active Probe)	
NFW31S Series (Cut-off frequency 50MHz)		 Level before filter mounting	The NFW31S's steep attenuation characteristic means excellent EMI suppression without waveform cornering.
Conventional Chip Solid type EMI Filter (NFM41CC 470pF)		 Level before filter mounting	3-terminal capacitors suppress signal frequencies as EMI frequencies so the signal waveform is distorted.
Filter Combined with Conventional LCs	 L : Chip Inductor C : Chip Capacitor (270pF)	 Level before filter mounting	Combinations of inductors and capacitors can yield a steep attenuation characteristic, but they require a great deal more mounting space. Moreover, at high frequencies the EMI suppression is less than that obtained by the NFW31S.

2

On-Board Type (DC) EMI Suppression Filters (EMIFIL®)



Chip EMIFIL® LC Combined Type for Large Current NFE31P/NFE61P/NFE61H Series

NFE31P Series

The chip "EMIFIL" NFE31P is a small size T-type circuit EMI suppression filter.

■ Features

1. Its large rated current of 6A and low voltage drop due to small DC resistance are suitable for DC power line use.
2. The feedthrough capacitor realizes excellent high frequency characteristics.
3. The structure incorporates built-in ferrite beads which minimize resonance with surrounding circuits.
4. 22 to 22,000pF lineups can be used for signal lines.

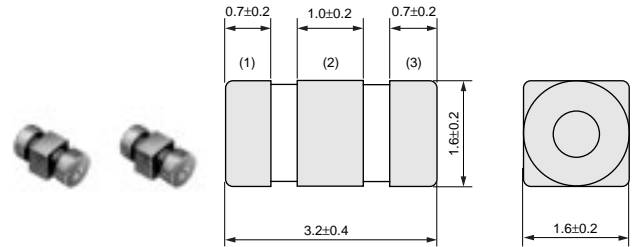

(in mm)

Part Number	Capacitance (pF)	Rated Voltage (Vdc)	Rated Current (A)	Insulation Resistance (M ohm)	Operating Temperature Range (°C)
NFE31PT220R1E9	22 +30%, -30%	25	6	1000 min.	-40 to 85
NFE31PT470C1E9	47 +50%, -20%	25	6	1000 min.	-40 to 85
NFE31PT101C1E9	100 +80%, -20%	25	6	1000 min.	-40 to 85
NFE31PT221D1E9	220 +50%, -20%	25	6	1000 min.	-40 to 85
NFE31PT471F1E9	470 +50%, -20%	25	6	1000 min.	-40 to 85
NFE31PT152Z1E9	1500 +50%, -20%	25	6	1000 min.	-40 to 85
NFE31PT222Z1E9	2200 +50%, -50%	25	6	1000 min.	-40 to 85

■ Equivalent Circuit

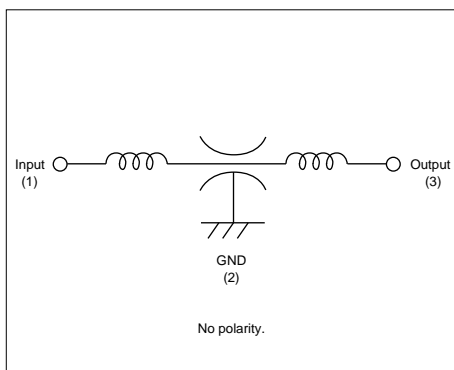

■ Insertion Loss Characteristics (Typical)

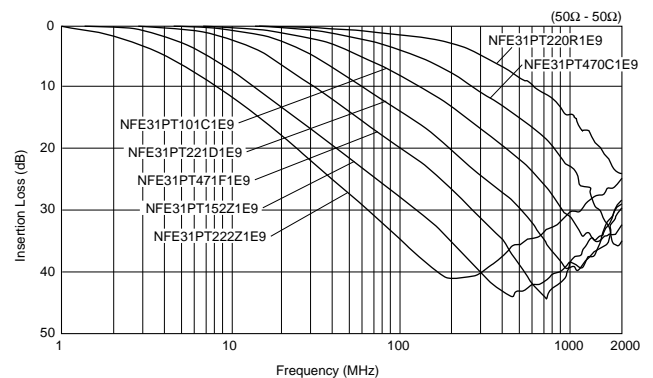

NFE61P Series

The chip "EMIFIL" NFE61P is a T-type circuit EMI suppression filter.

Feature

1. Its large rated current of 2A and low voltage drop due to small DC resistance are suitable for DC power line use.
2. The feedthrough capacitor realizes excellent high frequency characteristics.
3. The structure incorporates built-in ferrite beads which minimize resonance with surrounding circuits.
4. 33 to 4,700pF lineups can be used for signal lines.

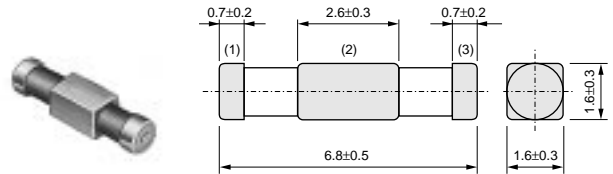

(in mm)

Part Number	Capacitance (pF)	Rated Voltage (Vdc)	Rated Current (A)	Insulation Resistance (M ohm)	Operating Temperature Range (°C)
NFE61PT330B1H9	33 +30%,-30%	50	2	1000 min.	-25 to 85
NFE61PT680B1H9	68 +30%,-30%	50	2	1000 min.	-25 to 85
NFE61PT101Z1H9	100 +30%,-30%	50	2	1000 min.	-25 to 85
NFE61PT181B1H9	180 +30%,-30%	50	2	1000 min.	-25 to 85
NFE61PT361B1H9	360 +20%,-20%	50	2	1000 min.	-25 to 85
NFE61PT681B1H9	680 +30%,-30%	50	2	1000 min.	-25 to 85
NFE61PT102E1H9	1000 +80%,-20%	50	2	1000 min.	-25 to 85
NFE61PT472C1H9	4700 +80%,-20%	50	2	1000 min.	-25 to 85

Equivalent Circuit

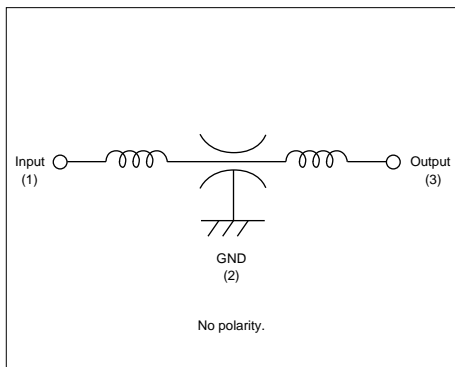

Insertion Loss Characteristics (Typical)

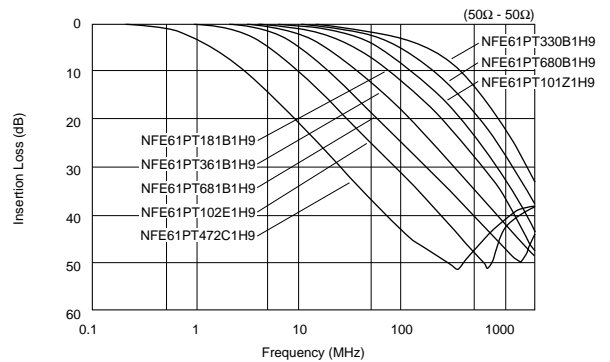

NFE61H Series

The T-type chip EMI Filter NFE61H series consists of a feedthrough capacitor and ferrite beads.

Extending the operating conditions of NFE61P, NFE61H series can be used in an application set under severe operating conditions.

■ Features

1. These filters have an extended operating temperature range of -55 to +125 degree C.
2. Its large rated current of 2A and low voltage drop due to small DC resistance are suitable for DC power line use.
3. The feedthrough capacitor realizes excellent high frequency characteristics.
4. The structure incorporates built-in ferrite beads which minimize resonance with surrounding circuits.
5. 33 to 3,300pF lineups can be used for signal lines.

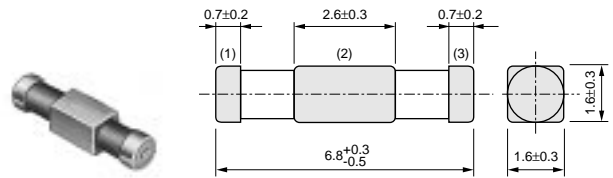

(in mm)

2

Part Number	Capacitance (pF)	Rated Voltage (Vdc)	Rated Current (A)	Insulation Resistance (M ohm)	Operating Temperature Range (°C)
NFE61HT330U2A9	33 +30%, -30%	100	2	1000 min.	-55 to 125
NFE61HT680R2A9	68 +30%, -30%	100	2	1000 min.	-55 to 125
NFE61HT101Z2A9	100 +30%, -30%	100	2	1000 min.	-55 to 125
NFE61HT181C2A9	180 +30%, -30%	100	2	1000 min.	-55 to 125
NFE61HT361C2A9	360 +20%, -20%	100	2	1000 min.	-55 to 125
NFE61HT681D2A9	680 +30%, -30%	100	2	1000 min.	-55 to 125
NFE61HT102F2A9	1000 +80%, -20%	100	2	1000 min.	-55 to 125
NFE61HT332Z2A9	3300 +80%, -20%	100	2	1000 min.	-55 to 125

■ Equivalent Circuit

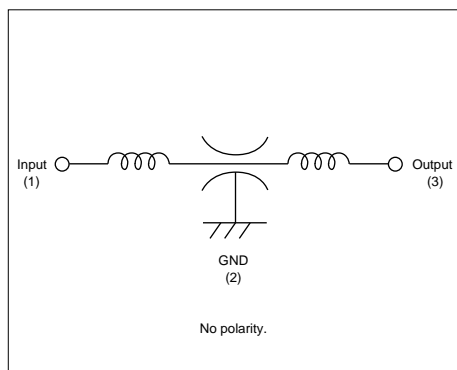

■ Insertion Loss Characteristics (Typical)

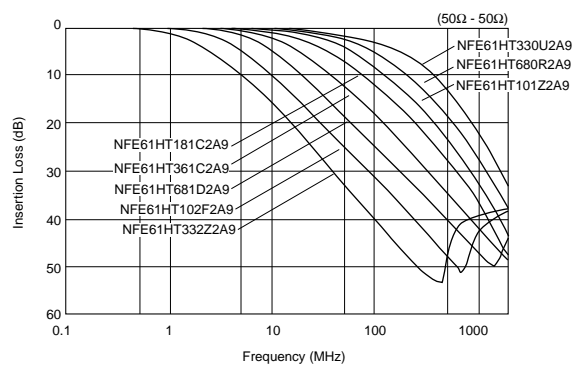

On-Board Type (DC) EMI Suppression Filters (EMIFIL[®])



Chip EMIFIL[®] for Large Current NFM18P/21P/3DP/41P Series

NFM18P Series

The NFM18P series is an EMI suppression filter for high speed IC power lines which realizes large capacitance 1 microF max. and rated current 2A in 1608 size by Murata's multilayer technology.

■ Features

1. Ultra-small size in 1.6x0.8mm.
2. 3-terminal structure with low residual (ESL)* and large capacitance 1 microF (max.) realize large insertion loss characteristics over wide frequency range.
3. Large rated current 2A is suitable for noise suppression of circuits which require large current.
4. The NFM18P series has line up of capacitance 0.1 to 1.0 microF.

* Not exceeding one-tenth of monolithic ceramic capacitors (2-terminal).

■ Applications

1. Noise suppression for large capacitance circuits such as high speed IC power lines
2. Control change of voltage for high speed IC

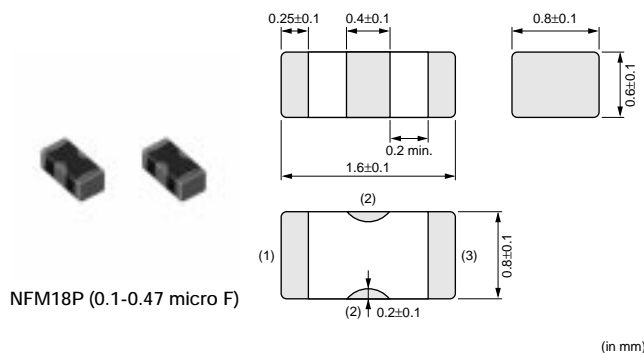
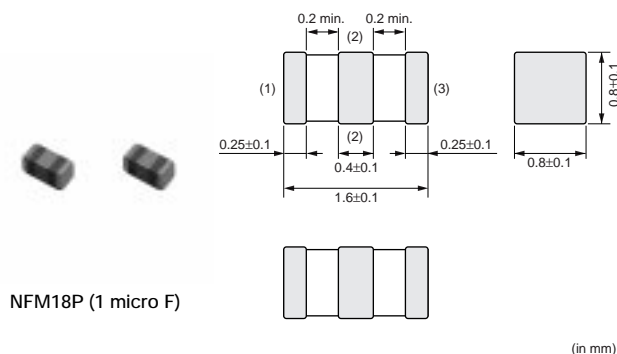

Part Number	Capacitance (μF)	Rated Voltage (Vdc)	Rated Current (A)	Insulation Resistance (M ohm)	Operating Temperature Range (°C)
NFM18PC104R1C3	0.1 +20%, -20%	16	2	1000 min.	-55 to 125
NFM18PC224R0J3	0.22 +20%, -20%	6.3	2	1000 min.	-55 to 125
NFM18PC474R0J3	0.47 +20%, -20%	6.3	2	1000 min.	-55 to 125
NFM18PC105R0J3	1.0 +20%, -20%	6.3	2	500 min.	-55 to 105

■ Equivalent Circuit

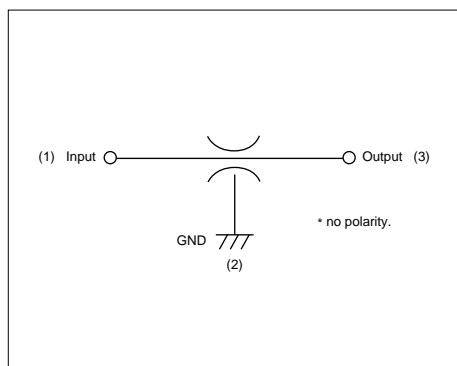

■ Insertion Loss Characteristics

NFM18P Series

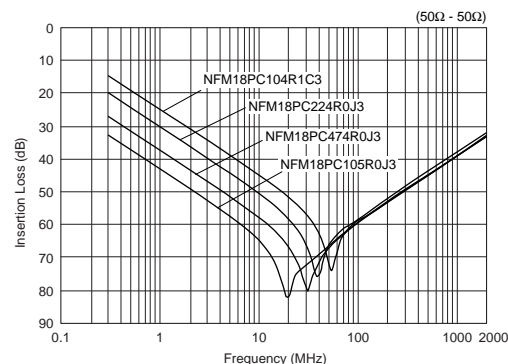

NFM21P Series

NFM21P is a 3-terminal structure component. This product can be applied to large current DC power lines. NFM21P is suitable for noise suppression of DC power lines where relatively operates large current.

■ Features

1. The rated current of 4A is suitable for IC's individual power lines.
2. Small dimension enables higher density packaging.
NFM21P is much smaller size (2.0x1.25x0.85mm).
3. Murata's original internal electrode structure design realizes excellent EMI suppression effects from low frequency to high frequency.

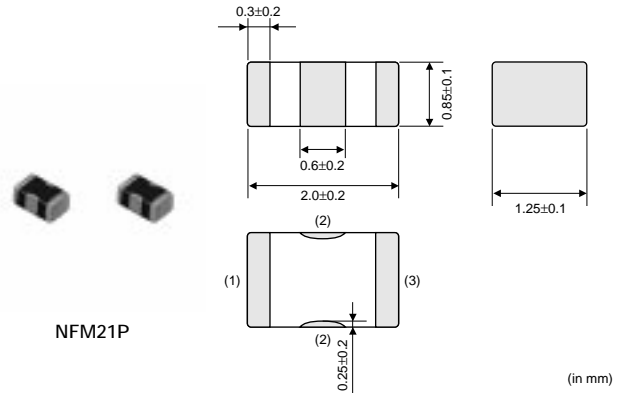

Part Number	Capacitance (μF)	Rated Voltage (Vdc)	Rated Current (A)	Insulation Resistance (M ohm)	Operating Temperature Range (°C)
NFM21PC104R1E3	0.1 +20%, -20%	25	2	1000 min.	-55 to 125
NFM21PC224R1C3	0.22 +20%, -20%	16	2	1000 min.	-55 to 125
NFM21PC474R1C3	0.47 +20%, -20%	16	2	1000 min.	-55 to 125
NFM21PC105B1A3	1.0 +20%, -20%	10	4	500 min.	-40 to 85
NFM21PC105F1C3	1.0 +80%, -20%	16	2	500 min.	-40 to 85

■ Equivalent Circuit

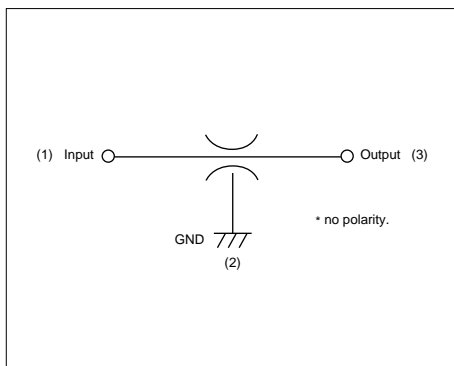

■ Insertion Loss Characteristics

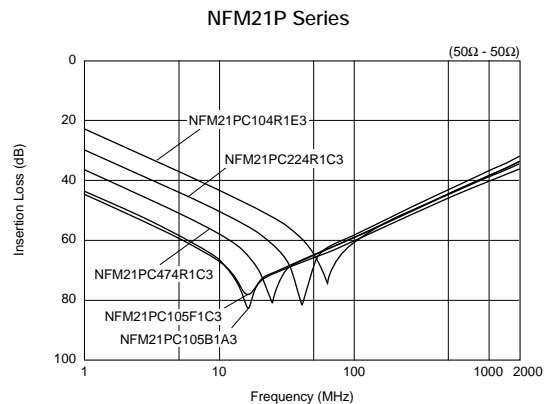

NFM3DP Series

The chip "EMIFIL" NFM3DP is a chip type 3-terminal capacitor with high rated current of 2A. This series is suited for noise suppression in DC power supply lines of digital instruments.

■ Features

1. Large rated current (2A) is suitable for application in DC power lines.
2. Small size (3.2x1.25mm) and low profile (0.7mm max.)

■ Applications

1. Personal computers, word processors and peripherals
2. Telephones, PPCs, communications equipment, etc.
3. Digital TVs, VCRs
4. Telecommunications equipment

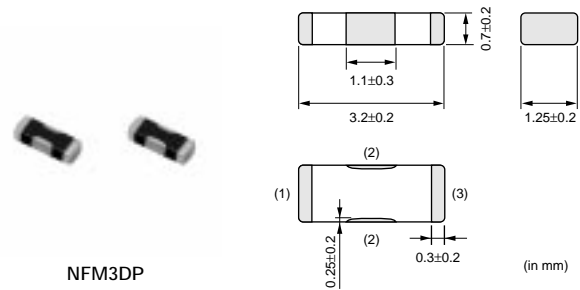

Part Number	Capacitance (μF)	Rated Voltage (Vdc)	Rated Current (A)	Insulation Resistance (M ohm)	Operating Temperature Range (°C)
NFM3DPC223R1H3	0.022 +20%,-20%	50	2	1000 min.	-55 to 85

■ Equivalent Circuit

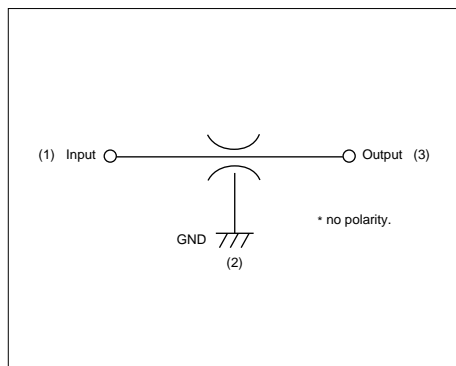

■ Insertion Loss Characteristics

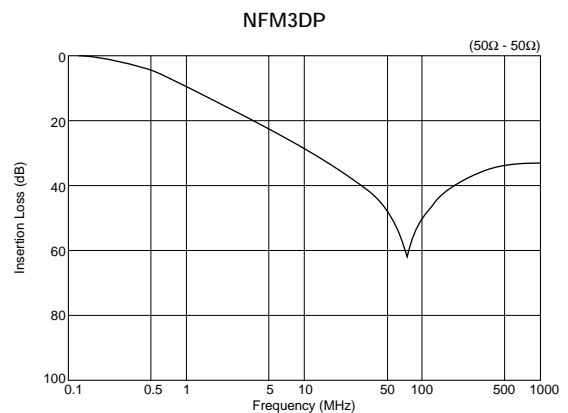

■ Notice (Rating)

When the NFM3DP series is used in operating temperatures exceeding +85°C, derating of current is necessary. Please apply the derating curve shown below according to the operating temperature.

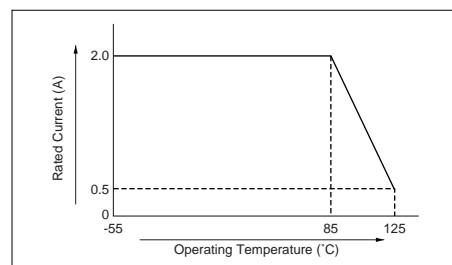

NFM41P Series

The chip "EMIFIL" NFM41P series consists of 3-terminal structure SMT components. These components are able to be applied to large current DC power lines. NFM41P series are suitable in noise suppression in DC lines where relatively large currents operate.

■ Features

1. Large rated current (2A) is suitable for the application in DC power lines.
2. High electrostatic capacitance and remarkable high frequency performance are effective for immunity against surge noise and pulse noise.

■ Applications

1. Personal computers, word processors and peripherals
2. Telephones, PPCs, communications equipment, etc.
3. Digital TVs, VCRs
4. Telecommunications equipment

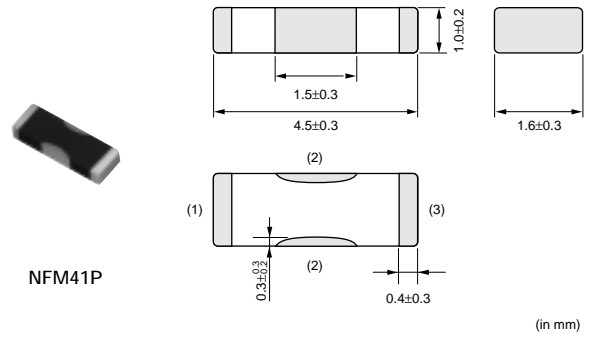

2

Part Number	Capacitance (μF)	Rated Voltage (Vdc)	Rated Current (A)	Insulation Resistance (M ohm)	Operating Temperature Range (°C)
NFM41PC204F1H3	0.2 +80%, -20%	50	2	1000 min.	-55 to 85

■ Equivalent Circuit

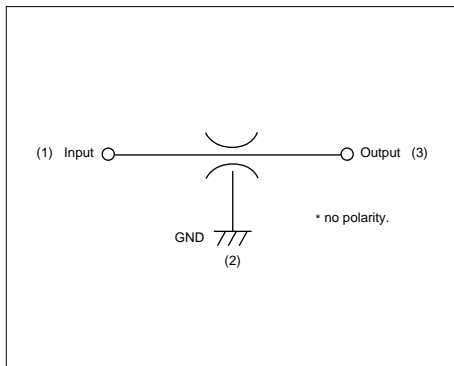

■ Insertion Loss Characteristics

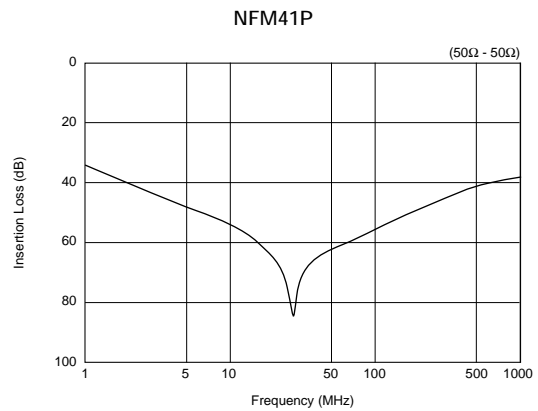

On-Board Type (DC) EMI Suppression Filters (EMIFIL®)



Chip EMIGUARD® (EMIFIL® with Varistor Function) Part Numbering

Chip EMIGUARD® (EMIFIL® with Varistor Function)

(Global Part Number) **VF** **M** **41** **R** **N** **222** **N** **1C** **L**
① ② ③ ④ ⑤ ⑥ ⑦ ⑧ ⑨

① Product ID

Product ID	
VF	Chip EMIGUARD®

② Structure

Code	Structure
M	Monolithic Type

③ Dimensions (L×W)

Code	Dimensions (L×W)	EIA
41	4.5×1.6mm	1806

④ Outer Electrode

Code	Outer Electrode
R	Standard Type

⑤ Category

Code	Category
N	Standard

⑥ Capacitance

Expressed by three figures. The unit is in pico-farad (pF). The first and second figures are significant digits, and the third figure expresses the number of zeros which follow the two figures.

⑦ Capacitance Tolerance

Code	Capacitance Tolerance
N	±30%

⑧ Rated Voltage

Code	Rated Voltage
1C	16V

⑨ Packaging

Code	Packaging
L	Plastic Taping (ø180mm Reel)
B	Bulk

3

On-Board Type (DC) EMI Suppression Filters (EMIFIL®)



Chip EMIGUARD® (EMIFIL® with Varistor Function) VFM41R Series

■ Features

The VFM41R series is a chip type EMI filter with varistor function. Its 3-terminal structure provides high performance by suppressing high frequency noise and absorbing surge noise. VFM41R can meet both EMI noise and surge noise.

■ Applications

ESD surge protection and EMI suppression in various electric equipment such as car electronic equipment, portable electronic equipment, telecommunication terminals, office automation equipment, home automation equipment or factory automation equipment

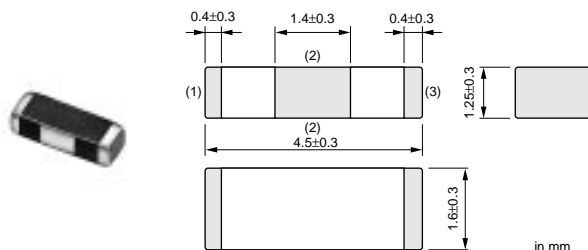

Part Number	Rated Voltage (Vdc)	Varistor Voltage (V)	Clamping Voltage (max.)	Capacitance (pF)	Rated Current (mA)	Peak Pulse Current (A)	Operating Temperature Range (°C)
VFM41RN222N1C	16	27 +5V,-5V	50V(V2A)	2200 +30%,-30%	200	50	-40 to 125

Please refer to Part Numbering for Type and Length of Lead.

3

■ Equivalent Circuit

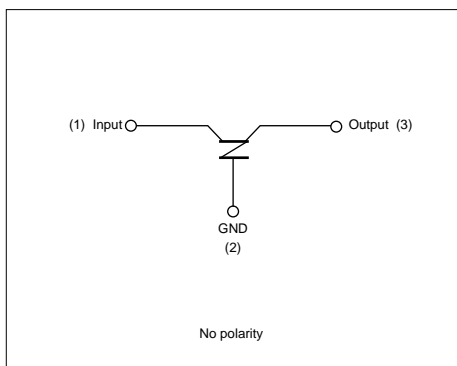

■ Insertion Loss Characteristics

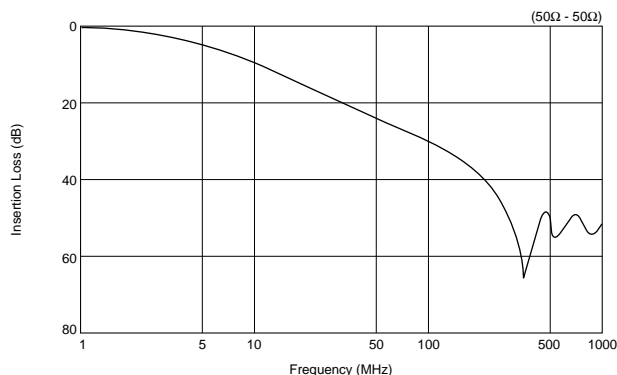

Noise Suppression Effect of VFM Series

Impulse Noise Absorption (Comparison between VFM41R and Standard 2-terminal Varistor)

[TESTING CIRCUIT]

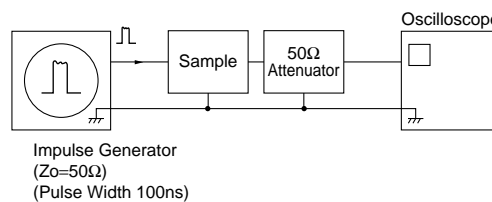

Type of Filter	EMI Suppression Effect	Description
Original Waveform	<p>Voltage Waveform</p> <p>Frequency Spectrum</p>	<p>The Lower chart is a frequency response of the upper chart. Note that the scale of original wave chart and that of the output wave chart is different because of circumstances.</p>
The commonly used 2-terminal varistor	<p>* Final voltage falls below 0V because of the effect of signal reflection.</p> <p>Voltage Waveform</p> <p>Frequency Spectrum</p>	<p>The rising part of pulse, which is mostly consists of high-frequency element, remains because inductance in electrodes becomes obstacle.</p>
Chip Solid EMIGUARD® VFM41R	<p>Voltage Waveform</p> <p>Frequency Spectrum</p>	<p>The 3-terminal structure minimizes the effect of inductance in electrodes and pulse rising noise is absorbed completely.</p>

On-Board Type (DC) EMI Suppression Filters (EMIFIL®)



Chip Common Mode Choke Coils Part Numbering

Chip Common Mode Choke Coils

(Global Part Number)

DL	W	21	S	N	371	S	Q	2	L
①	②	③	④	⑤	⑥	⑦	⑧	⑨	⑩

① Product ID

Product ID	
DL	Chip Common Mode Choke Coils

② Structure

Code	Structure
W	Winding Type
M	Monolithic Type
P	Film Type

③ Dimensions (L×W)

Code	Dimensions (L×W)	EIA
11	1.25×1.0mm	0504
21	2.0×1.2mm	0805
31	3.2×1.6mm	1206
2H	2.5×2.0mm	1008
5A	5.0×3.6mm	2014
5B	5.0×5.0mm	2020

④ Type

Code	Type
S	Magnetically Shielded One Circuit Type
D	Magnetically Shielded Two Circuit Type
H	Open Magnetic One Circuit Type
G	Magnetically Monolithic Type (sectional winding)

⑩ Packaging

Code	Packaging	Series
K	Plastic Taping (ø330mm Reel)	DLW5AH/DLW5BS
L	Plastic Taping (ø180mm Reel)	All series
B	Bulk	All series

⑤ Category

Code	Category
N	Standard Type

⑥ Impedance

Typical impedance at 100MHz is expressed by three figures. The unit is in ohm (Ω). The first and second figures are significant digits, and the third figure expresses the number of zeros which follow the two figures.

⑦ Circuit

Ex.)

Code	Circuit	Series
S	Standard Type	except DLP31D
M		DLP31D

⑧ Features

Code	Features
L	Expressed by a letter.
Q	
Z	

⑨ Number of Signal Line

Code	Number of Signal Line
2	Two Lines
3	Three Lines
4	Four Lines

On-Board Type (DC) EMI Suppression Filters (EMIFIL®)



Chip Common Mode Choke Coils Film Type DLP11S/DLP31S Series

DLP11S Series

■ Features

1. Small size and tight dimensional tolerance
SIZE : 1.25x1.0x0.82mm tolerance : +/-0.1mm
2. Useful impedance line-up 90/120/160/200ohm
3. High noise suppression for high frequency
4. No distortion to high-speed signal transmission

■ Applications

Common mode noise suppression of high speed differential signal lines for USB, IEEE1394, LVDS.

1. Note PC, PDA
2. Cellular phone
3. Digital Still Camera, Digital Video Camera

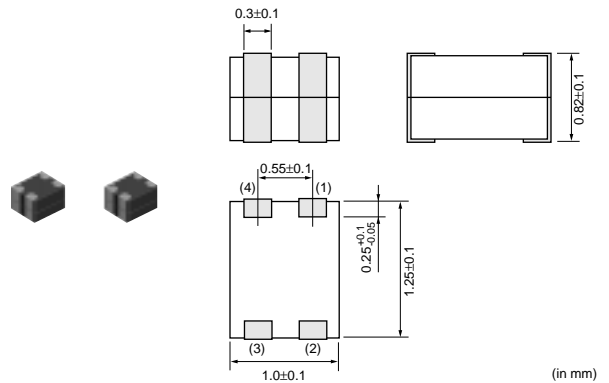

Part Number	Common Mode Impedance (at 100MHz, 20 degree C) (ohm)	Rated Current (mA)	Rated Voltage (Vdc)	Insulation Resistance (M ohm)	Withstand Voltage (Vdc)	DC Resistance (ohm)
DLP11SN900SL2	90 ±20%	160	5	100 min.	12.5	1.4 ±25%
DLP11SN121SL2	120 ±20%	140	5	100 min.	12.5	2.0 ±25%
DLP11SN161SL2	160 ±20%	120	5	100 min.	12.5	2.7 ±25%
DLP11SN201SL2	200 ±20%	130	5	100 min.	12.5	2.5 ±25%

Operating Temperature Range : -40°C to 85°C

■ Equivalent Circuit

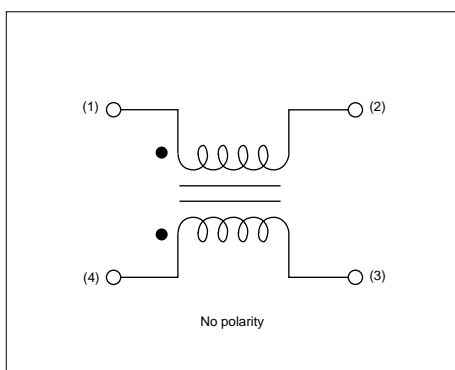

■ Impedance-Frequency Characteristics

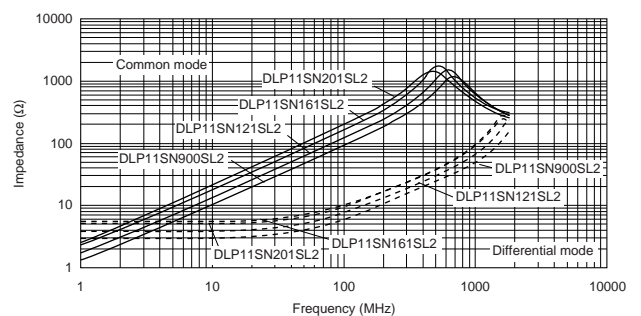

DLP31S Series

DLP31S series is chip common mode choke coil that realizes high impedance in a small size with ferrite material technology and film processing technology. DLP31S series has excellent performance at high frequency range. It is suitable for differential signal line application.

■ Features

1. Small size, low profile, SMD. 3.2x1.6x1.15mm (tolerance: 0.15mm)
2. High common mode impedance (550ohm at 100MHz typ.) in small size.
3. DLP31S suppresses high frequency noise that was unable to be suppressed with existing common mode choke coils. Suitable for differential signal lines as like USB, because DLP31S does not provide distortion to high speed signal transmission due to its high coupling (coupling coefficient: 0.98 min.)

■ Applications

1. USB lines of PC, peripheral equipment.
2. LVDS lines of Note-PC, LCD.
3. USB lines of digital AV equipment such as digital cameras.

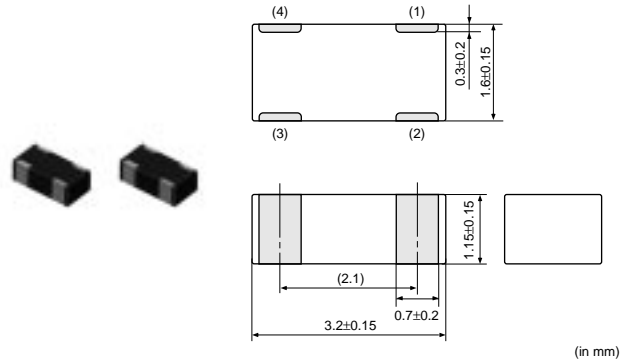

Part Number	Common Mode Impedance (at 100MHz, 20 degree C) (ohm)	Rated Current (mA)	Rated Voltage (Vdc)	Insulation Resistance (M ohm)	Withstand Voltage (Vdc)	DC Resistance (ohm)
DLP31SN121SL2	120 ±20%	100	16	100 min.	40	2.0 max.
DLP31SN221SL2	220 ±20%	100	16	100 min.	40	2.5 max.
DLP31SN551SL2	550 ±20%	100	16	100 min.	40	3.6 max.

Operating Temperature Range : -40°C to 85°C

■ Equivalent Circuit

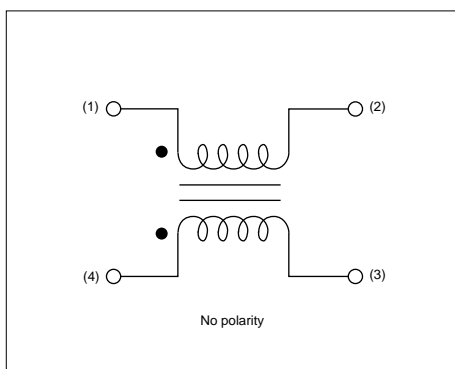

■ Impedance-Frequency Characteristics

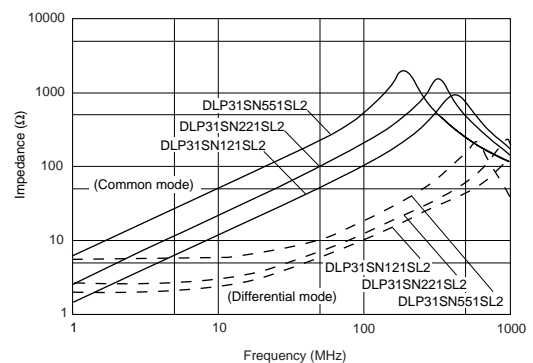

On-Board Type (DC) EMI Suppression Filters (EMIFIL[®])

Chip Common Mode Choke Coils Arrays Film Type DLP31D Series

DLP31D Series

DLP31D series is chip common mode choke coil array which realizes high coupling and high impedance in a small size with ferrite material technology and thin film processing technology.

■ Features

1. 2 components are included in 3.2x1.6mm
2. Thin type 1.15mm
3. High common mode Impedance characteristics (max. 440ohm, at 100MHz)
4. The DLP31D can suppress common mode noise without damage to signal wave.

■ Applications

Common mode noise suppression of high speed differential signal lines for USB, IEEE1394, LVDS.

1. Main board of personal computer, note PC
2. Printer, Scanner
3. LCD monitor
4. Game equipment
5. PC peripheral equipment

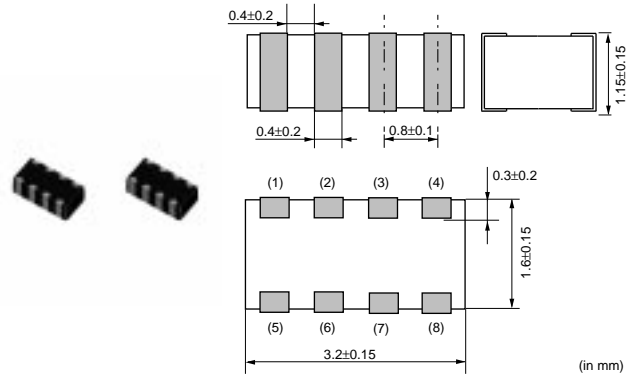

Part Number	Common Mode Impedance (at 100MHz, 20 degree C) (ohm)	Rated Current (mA)	Rated Voltage (Vdc)	Insulation Resistance (M ohm)	Withstand Voltage (Vdc)	DC Resistance (ohm)
DLP31DN900ML4	90 ±20%	160	10	100 min.	25	1.1 max.
DLP31DN131ML4	130 ±20%	120	10	100 min.	25	1.6 max.
DLP31DN201ML4	200 ±20%	100	10	100 min.	25	2.2 max.
DLP31DN321ML4	320 ±20%	80	10	100 min.	25	3.5 max.
DLP31DN441ML4	440 ±20%	70	10	100 min.	25	4.3 max.

Operating Temperature Range : -40°C to 85°C

■ Equivalent Circuit

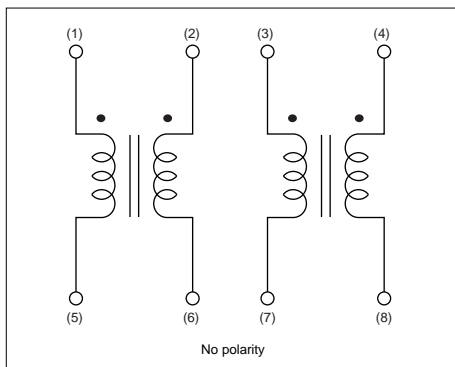

■ Impedance-Frequency Characteristics

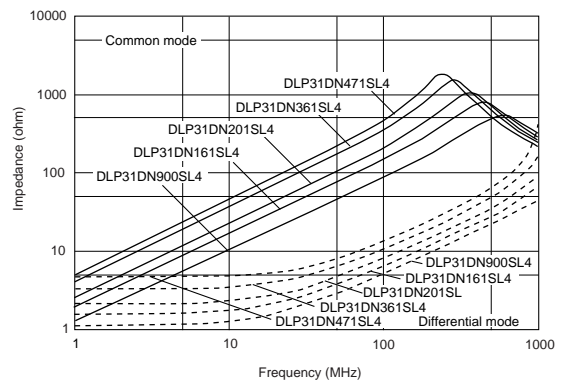

On-Board Type (DC) EMI Suppression Filters (EMIFIL[®])



Chip Common Mode Choke Coils Monolithic Type DLM2HG Series

DLM2HG Series is a high quality noise suppression filter for headphone lines of high quality digital music equipment.

■ Features

1. Low distortion in audio signal, Low crosstalk.
2. Effective in noise suppression both of common mode and of differential mode.
3. Small size, low profile, SMD 2.5x2.0x1.2mm

■ Application

1. Headphone lines of digital music equipment such as DVD, MD player.
2. Headphone lines of Note-PC, PDA

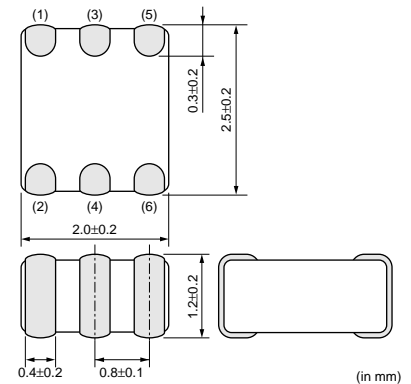

Part Number	Common Mode Impedance (at 100MHz, 20 degree C) (ohm)	Rated Current (mA)	Rated Voltage (Vdc)	Insulation Resistance (M ohm)	Withstand Voltage (Vdc)	DC Resistance (ohm)
DLM2HGN601SZ3	600 ±25%	100	16	100 min.	100	0.40 max.

Operating Temperature Range : -40°C to 85°C

■ Equivalent Circuit

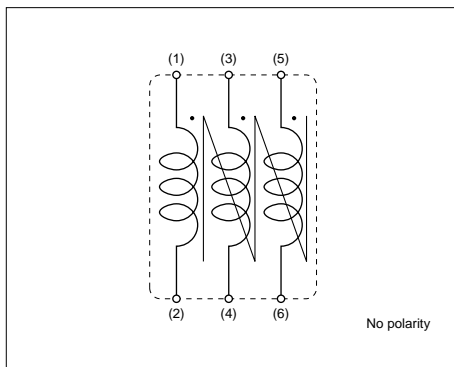

■ Impedance-Frequency Characteristics

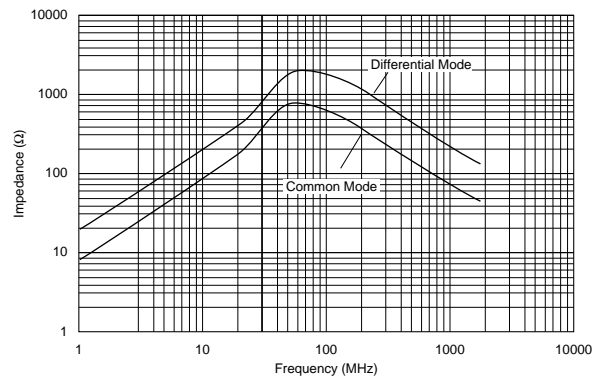

On-Board Type (DC) EMI Suppression Filters (EMIFIL[®])



Chip Common Mode Choke Coils Winding Type DLW21S/DLW21H/DLW31S Series

DLW21S Series

■ Features

- DLW21S series realizes small size and low profile.
2.0x1.2x1.2mm
- High common mode impedance at high frequency effects excellent noise suppression performance.
- Various common mode impedance items of 67 to 370ohm can be used, considering noise level and signal frequency.
- DLW21S series enables noise suppression for differential signal line without distortion in high speed signal transmission due to its high coupling.
- Lead is not contained in the product.
- Small dimension enables higher density packaging.



DLW21S

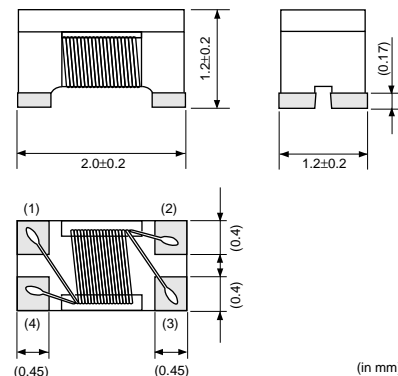

(in mm)

■ Applications

- USB lines of PC, Peripheral equipment.
- LVDS lines of Note-PC, LCD.
- USB lines of Small digital AV equipment such as digital camera.

Part Number	Common Mode Impedance (at 100MHz, 20 degree C) (ohm)	Rated Current (mA)	Rated Voltage (Vdc)	Insulation Resistance (M ohm)	Withstand Voltage (Vdc)	DC Resistance (ohm)
DLW21SN670SQ2	67 ±25%	400	50	10 min.	125	0.25 max.
DLW21SN900SQ2	90 ±25%	330	50	10 min.	125	0.35 max.
DLW21SN121SQ2	120 ±25%	370	50	10 min.	125	0.30 max.
DLW21SN181SQ2	180 ±25%	330	50	10 min.	125	0.35 max.
DLW21SN261SQ2	260 ±25%	300	50	10 min.	125	0.40 max.
DLW21SN371SQ2	370 ±25%	280	50	10 min.	125	0.45 max.

Operating Temperature Range : -40°C to 85°C

■ Equivalent Circuit

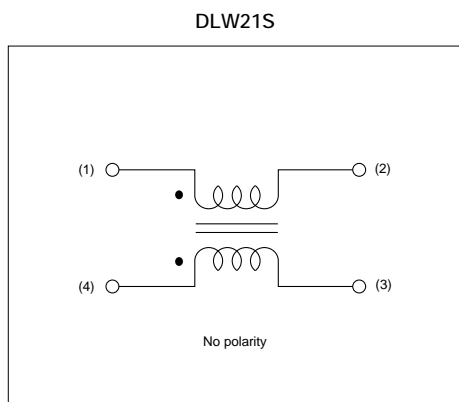

■ Impedance-Frequency Characteristics

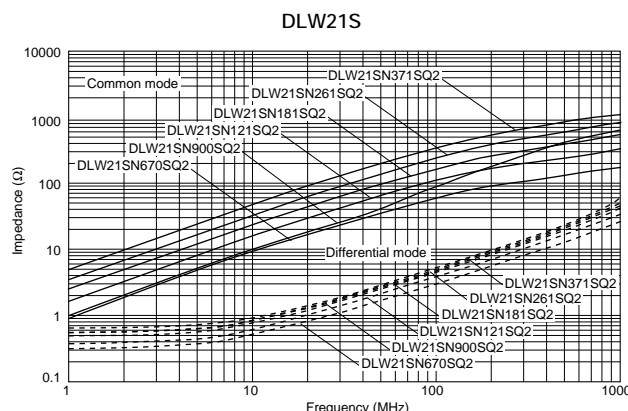

DLW21H Series

■ Features

1. Small size and low profile (2.0x1.2x0.9mm).
Excellent noise suppression for sets of small and thin size.
2. High common mode impedance at high frequency effects excellent noise suppression performance.
3. Various common mode impedance from 67 to 180 ohm can be used, selected depending on noise level and signal frequency.
4. Suitable for differential signal line like USB2.0, IEEE1394 and LVDS, because DLW21H does not provide distortion to high speed signal transmission due to its high coupling. (USB2.0: DLW21HN900SQ2)
5. Lead is not contained in the product.
6. Small dimension enables higher density mounting.

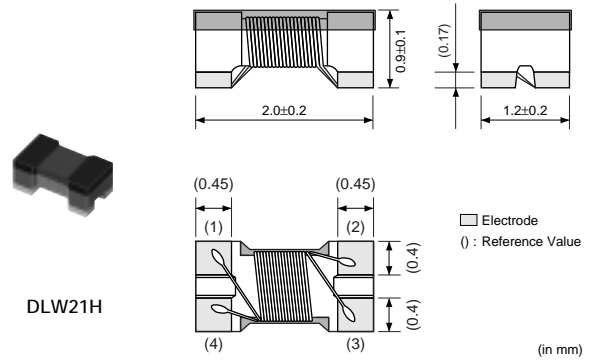

■ Applications

Common mode noise suppression of signal lines in high speed and high density digital equipment such as personal computers and peripherals and telecommunication equipment.

Part Number	Common Mode Impedance (at 100MHz, 20 degree C) (ohm)	Rated Current (mA)	Rated Voltage (Vdc)	Insulation Resistance (M ohm)	Withstand Voltage (Vdc)	DC Resistance (ohm)
DLW21HN670SQ2	67 (Typ.)	330	50	10 min.	125	0.35 max.
DLW21HN900SQ2	90 (Typ.)	330	50	10 min.	125	0.35 max.
DLW21HN121SQ2	120 (Typ.)	280	50	10 min.	125	0.45 max.
DLW21HN181SQ2	180 (Typ.)	250	50	10 min.	125	0.50 max.

Operating Temperature Range : -40°C to 85°C

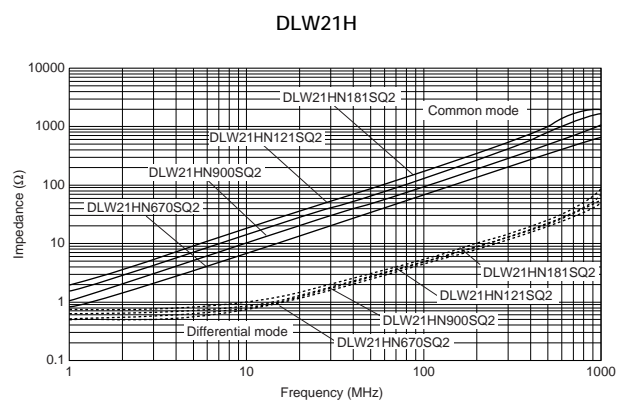
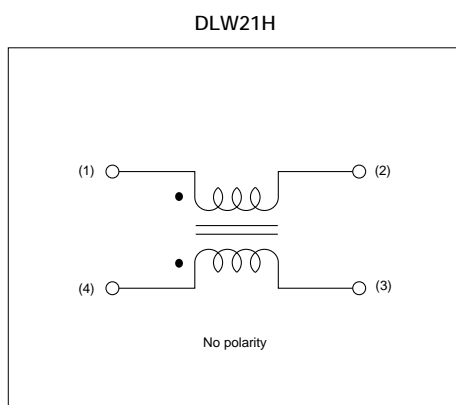

DLW31S Series

■ Features

- DLW31S realizes small size and low profile.
3.2x1.6x1.9mm.
- High common mode impedance at high frequency effects excellent noise suppression performance.
- Various common mode impedance items of 90 to 2200ohm can be used, considering noise level and signal frequency.
- DLW31S series enables noise suppression for differential signal line without distortion in high speed signal transmission due to its high coupling.
- Lead is not contained in the product.
- Small dimension enables higher density packaging.

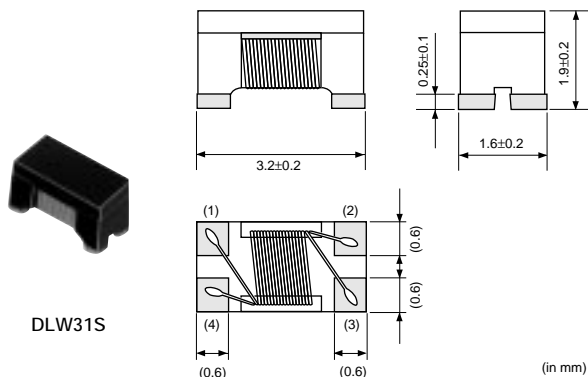

■ Applications

- USB lines of PC, Peripheral equipment.
- LVDS lines of Note-PC, LCD.

Part Number	Common Mode Impedance (at 100MHz, 20 degree C) (ohm)	Rated Current (mA)	Rated Voltage (Vdc)	Insulation Resistance (M ohm)	Withstand Voltage (Vdc)	DC Resistance (ohm)
DLW31SN900SQ2	90 (Typ.)	370	50	10 min.	125	0.3 max.
DLW31SN161SQ2	160 (Typ.)	340	50	10 min.	125	0.4 max.
DLW31SN261SQ2	260 (Typ.)	310	50	10 min.	125	0.5 max.
DLW31SN601SQ2	600 (Typ.)	260	50	10 min.	125	0.8 max.
DLW31SN102SQ2	1000 (Typ.)	230	50	10 min.	125	1.0 max.
DLW31SN222SQ2	2200 (Typ.)	200	50	10 min.	125	1.2 max.

Operating Temperature Range : -40°C to 85°C

■ Equivalent Circuit

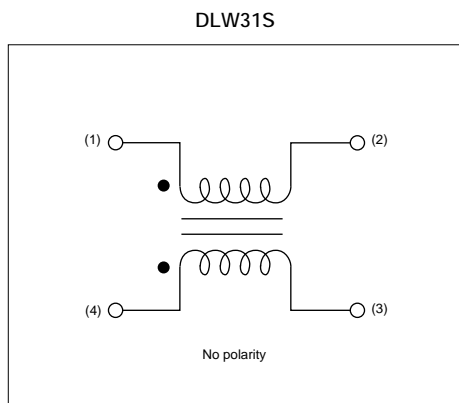

■ Impedance-Frequency Characteristics

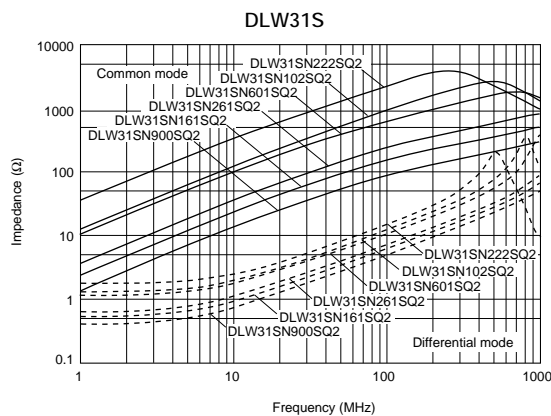

On-Board Type (DC) EMI Suppression Filters (EMIFIL®)



Chip Common Mode Choke Coils Winding Type for Large Current DLW5AH/DLW5BS Series

The DLW5AH/5BS series is high performance wound type chip common mode choke coil.

■ Features

1. High impedance (max. of 4000ohm at 100MHz : DLW5AH) enables great noise suppression.
2. Large rated current (max. of 5A) is suitable for power line use.
3. DLW5AH/BS series does not damage high speed signal due to high coupling common mode choke coil structure.
4. Automatic mounting can be applied.

■ Applications

1. DC power lines in AC adapter of Portable equipment.
2. DC power lines of DC-DC converter, battery charger.

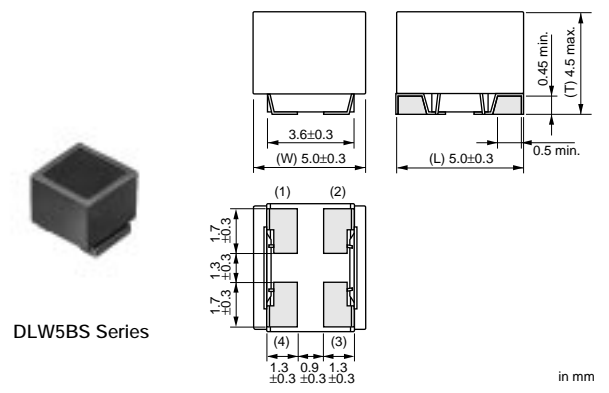
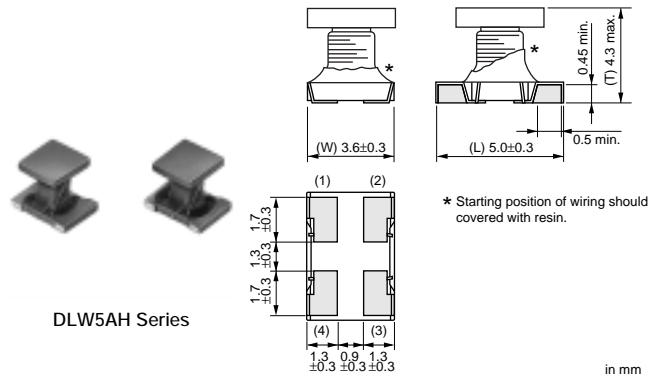

4

Part Number	Common Mode Impedance (at 100MHz, 20 degree C) (ohm)	Rated Current (mA)	Rated Voltage (Vdc)	Insulation Resistance (M ohm)	Withstand Voltage (Vdc)	DC Resistance (ohm)
DLW5AHN402SQ2	4000 (Typ.)	200	50	10 min.	125	3.0 max.
DLW5BSN191SQ2	190 (Typ.)	5000	50	10 min.	125	0.02 max.
DLW5BSN351SQ2	350 (Typ.)	2000	50	10 min.	125	0.04 max.
DLW5BSN102SQ2	1000 (Typ.)	1500	50	10 min.	125	0.06 max.
DLW5BSN152SQ2	1500 (Typ.)	1000	50	10 min.	125	0.1 max.
DLW5BSN302SQ2	3000 (Typ.)	500	50	10 min.	125	0.3 max.

Operating Temperature Range : -25°C to 85°C

■ Equivalent Circuit

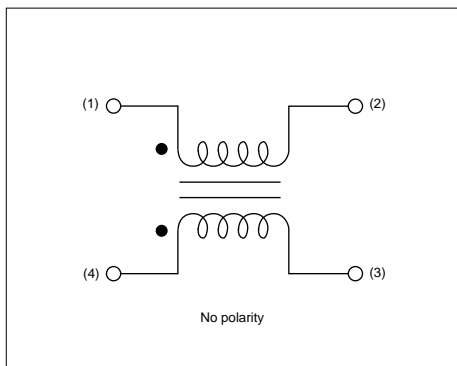

■ Impedance-Frequency (Typical)

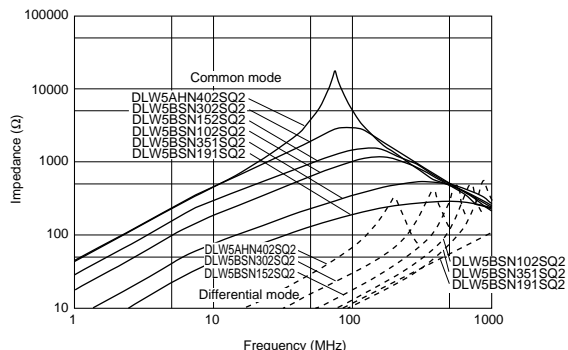

On-Board Type (DC) EMI Suppression Filters (EMIFIL®)



Ferrite Beads Inductors Part Numbering

Ferrite Beads Inductors

(Global Part Number) **BL 02 RN 2 R1 M 2 B**
① ② ③ ④ ⑤ ⑥ ⑦ ⑧

① Product ID

Product ID	
BL	Ferrite Beads Inductors

② Series

Code	Series
01	Beads ø3.6
02	Beads ø3.4
03	Beads ø2.3 max.

③ Beads Core Material

Code	Beads Core Material
RN	Standard Type

④ Numbers of Beads Core

Code	Numbers of Beads Core
1	1
2	2

⑤ Lead Type

Code	Lead Type
A1	Axial Straight Type
A2	Axial Crimp Type
R1	Radial Straight Type
R2	Radial Straight and wave formed Leads Type
R3	Radial Crimp Type

⑧ Packaging

Code	Packaging	Series
A	Ammo Pack	BL01/BL02/BL03
B	Bulk	All series
J	Paper Reel (ø320mm)	BL01

⑥ Lead Length, Space

Code	Lead Length, Space	Series
A	Bulk, Axial Type, 3.7mm	BL01
D	Bulk, Axial Type, 45.0mm	
E	Taping Axial Type, 26.0mm	
F	Taping, Axial Type, 52.0mm	
J	Bulk, Radial Type, 5.0mm	BL02/BL03
M	Bulk, Radial Type, 10.0mm	
N	Taping, Radial Type, 16.5mm	
P	Taping, Radial Type, 18.5mm	
Q	Taping, Radial Type, 20.0mm	

⑦ Lead Diameter

Code	Lead Diameter
1	ø0.60mm
2	ø0.65mm

On-Board Type (DC) EMI Suppression Filters (EMIFIL®)



Ferrite Beads Inductors BL01/BL02/BL03 Series

■ Features

BL01/02/03 series are ferrite beads with lead wires to produce a high frequency loss for suppression of noise. Simple construction and easy-to-use. Effective for low impedance circuits such as power supplies and grounds. Effective also for preventing overshoot and undershoot the digital signal in clocks or the like, and suppressing the higher harmonic wave. Suitable for prevention of abnormal oscillation at high frequency amplifying circuit.

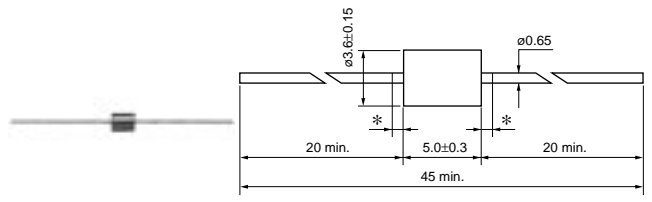

BL01RN1A1D2B

*Coating extending on leads : 1.5 max.

(in mm)

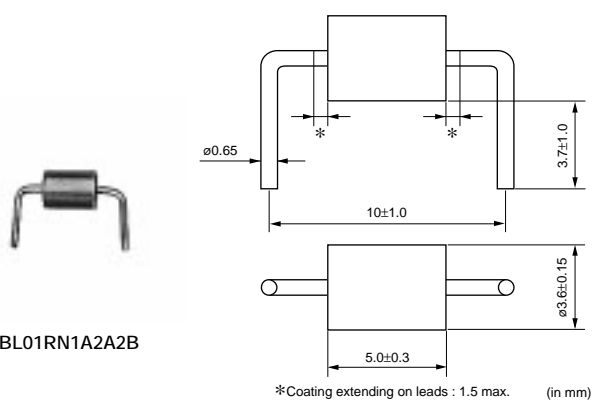

BL01RN1A2A2B

*Coating extending on leads : 1.5 max. (in mm)

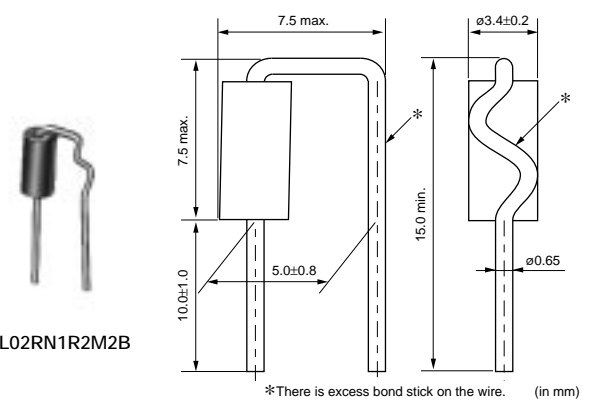

BL02RN1R2M2B

*There is excess bond stick on the wire. (in mm)

(in mm)

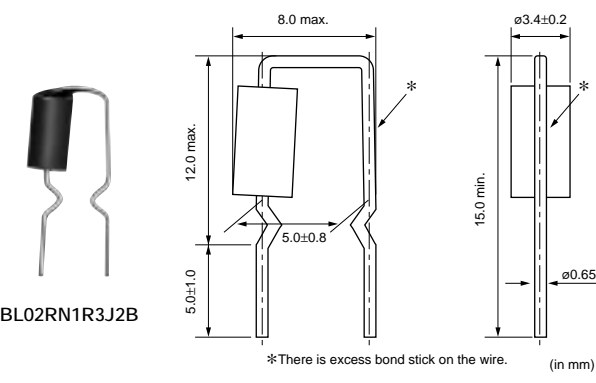

BL02RN1R3J2B

*There is excess bond stick on the wire. (in mm)

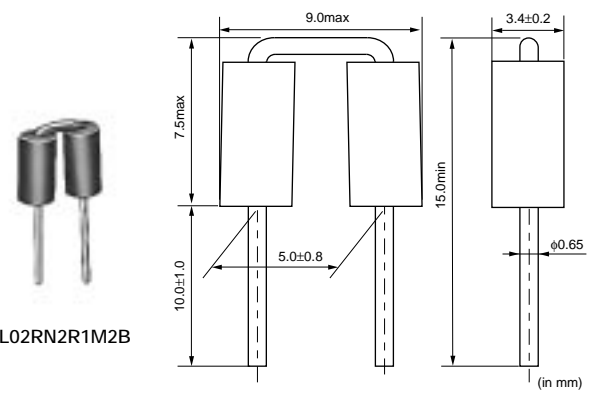

BL02RN2R1M2B

(in mm)

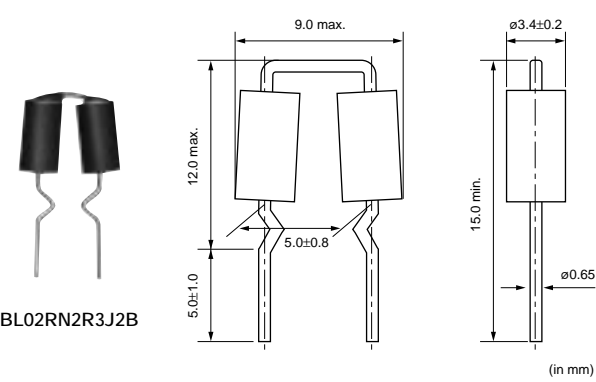

BL02RN2R3J2B

(in mm)

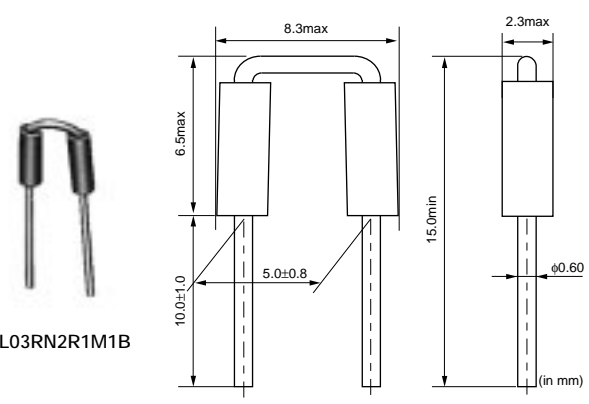

BL03RN2R1M1B

(in mm)

5



Part Number	Rated Current (A)	Operating Temperature Range (°C)
BL01RN1A1D2B	7	-40 to 85
BL01RN1A1E1A	6	-40 to 85
BL01RN1A1F1J	6	-40 to 85
BL01RN1A2A2B	7	-40 to 85
BL02RN1R2M2B	7	-40 to 85
BL02RN1R2N1A	6	-40 to 85
BL02RN1R2P1A	6	-40 to 85
BL02RN1R2Q1A	6	-40 to 85
BL02RN1R3J2B	7	-40 to 85
BL02RN1R3N1A	6	-40 to 85
BL02RN2R1M2B	7	-40 to 85
BL02RN2R1N1A	6	-40 to 85
BL02RN2R1P1A	6	-40 to 85
BL02RN2R1Q1A	6	-40 to 85
BL02RN2R3J2B	7	-40 to 85
BL02RN2R3N1A	6	-40 to 85
BL03RN2R1M1B	6	-40 to 85
BL03RN2R1N1A	6	-40 to 85
BL03RN2R1P1A	6	-40 to 85
BL03RN2R1Q1A	6	-40 to 85

■ Equivalent Circuit

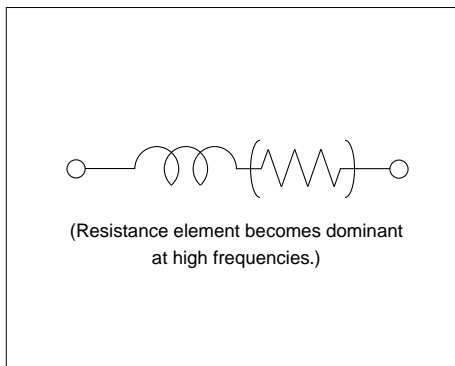

■ Impedance-Frequency Characteristics

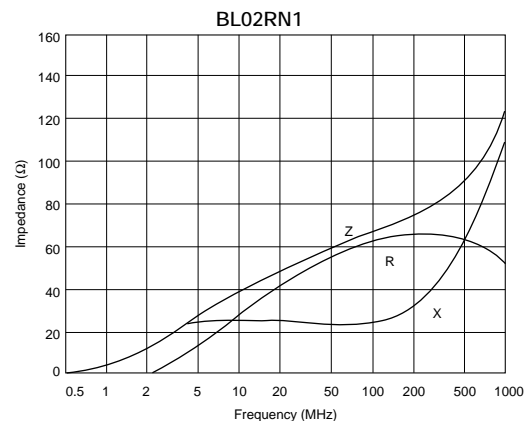
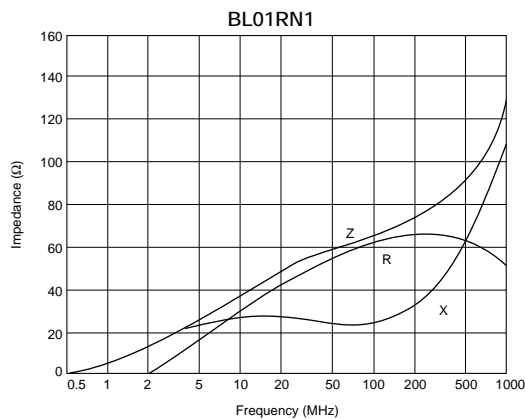

Continued on the following page.

↳ Continued from the preceding page.

■ Impedance-Frequency Characteristics

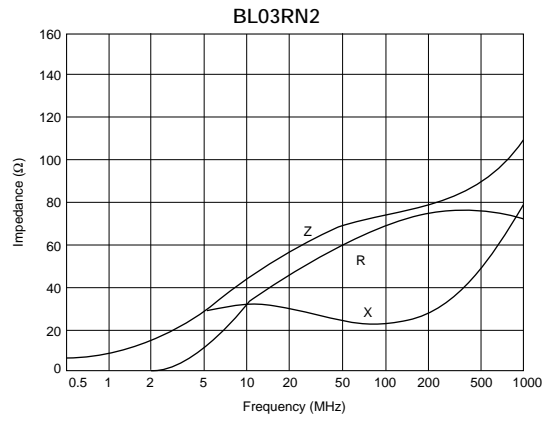
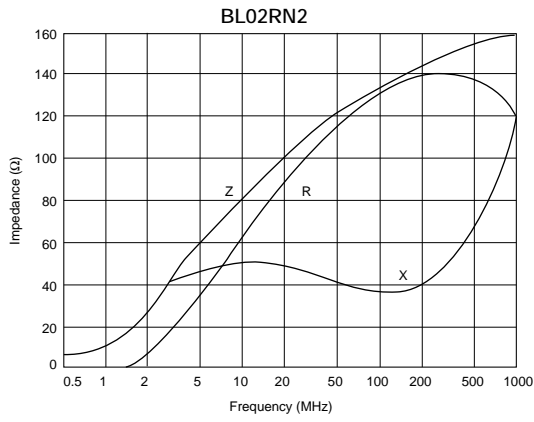

On-Board Type (DC) EMI Suppression Filters (EMIFIL®)



Disc Type EMIFIL® Part Numbering

Disc Type EMIFIL®

(Global Part Number) **DS S 9 H B3 2E 271 Q55 B**
① ② ③ ④ ⑤ ⑥ ⑦ ⑧ ⑨

① Product ID

Product ID	
DS	Three-terminals Capacitor

② Structure

Code	Structure
N	No Ferrite Beads Type
S	Built-in Ferrite Beads Type
T	with Ferrite Beads Type

③ Style

Code	Style
6	Diameter 8.0mm Type
9	Diameter 9.5mm Type

④ Category

Code	Category
N	for General Use
H	for Heavy-duty

⑤ Temperature Characteristics

Code	Capacitance Change
B3	±10% (Temperature Range : -25°C to +85°C)
C5	±22% (Temperature Range : -25°C to +85°C)
D3	+20/-30% (Temperature Range : -25°C to +85°C)
E3	+20/-55% (Temperature Range : -25°C to +85°C)
E5	+22/-56% (Temperature Range : -25°C to +85°C)
F3	+30/-80% (Temperature Range : -25°C to +85°C)
Z8	+30/-85% (Temperature Range : -10°C to +60°C)

⑥ Rated Voltage

Code	Rated Voltage
1C	16V
1H	50V
2A	100V
2E	250V

⑦ Capacitance

Expressed by three figures. The unit is in pico-farad (pF). The first and second figures are significant digits, and the third figure expresses the number of zeros which follow the two figures.

⑧ Lead Type/⑨ Packaging

Code	Lead Type	Lead Length* (in mm)	Packaging	Series
Q55B	Straight	25.0 min.	Bulk	All series
Q50B		4.0±0.5		DST9N/H
Q52B		6.0±1.0		DST9N
Q54B		4.0±0.5		DSN6/9, DSS6/9
Q56B		6.0±1.0		DSS6N
T41B	Incrimp	4.0±0.5	Paper Reel (ø320mm)	DSS9N/H, DST9N
T51B		25.0 min.		DSS9N/H
Q91J	Straight	20.0±1.0	Ammo Pack	DS□6, DSN9N/H
Q92J		16.5±1.0		All series except DSS9N/H
Q93J		18.5±1.0		DSS6N
Q91A		20.0±1.0		
Q92A		16.5±1.0		
Q93A		18.5±1.0		
U21A	Incrimp	16.5±1.0		
U31A		18.5±1.0		

*Lead Distance between Reference and Bottom Planes except Bulk.

On-Board Type (DC) EMI Suppression Filters (EMIFIL®)



Disc Type EMIFIL® DSN6/DSS6 Series

■ Features

DS_6 is compact, high performance lead type EMI suppression filter which can be mounted 2.54mm pitch. Its 3-terminal structure enables nice high frequency performance.

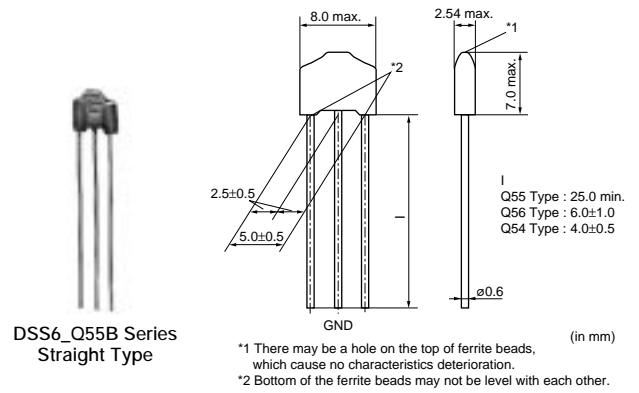
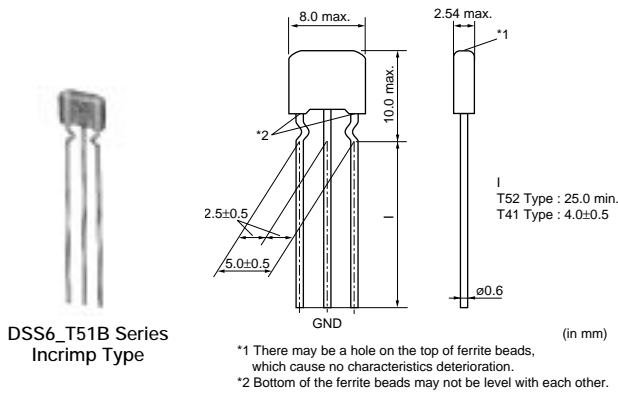
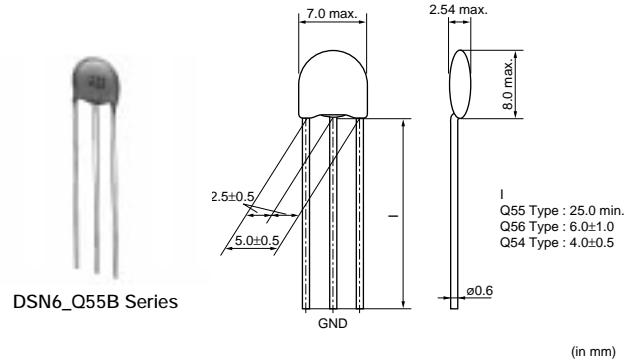

DSN6 Series

Part Number	Capacitance (pF)	Rated Voltage (Vdc)	Rated Current (A)	Operating Temperature Range (°C)
DSN6NC51H220	22 +20%, -20%	50	6	-25 to 85
DSN6NC51H330	33 +20%, -20%	50	6	-25 to 85
DSN6NC51H470	47 +20%, -20%	50	6	-25 to 85
DSN6NC51H101	100 +20%, -20%	50	6	-25 to 85
DSN6NC51H271	270 +20%, -20%	50	6	-25 to 85
DSN6NC51H102	1000 +20%, -20%	50	6	-25 to 85
DSN6NC51H222	2200 +20%, -20%	50	6	-25 to 85
DSN6NZ81H103	10000 +80%, -20%	50	6	-25 to 85

Please refer to Part Numbering for Type and Length of Lead.

■ Equivalent Circuit

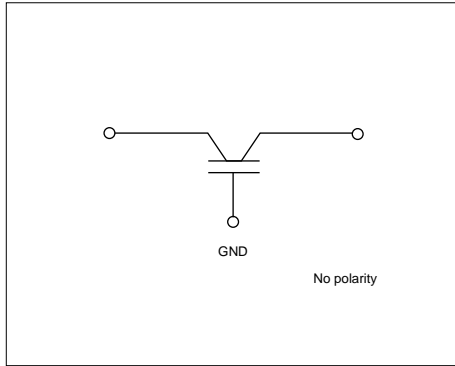

■ Insertion Loss Characteristics (Typical)

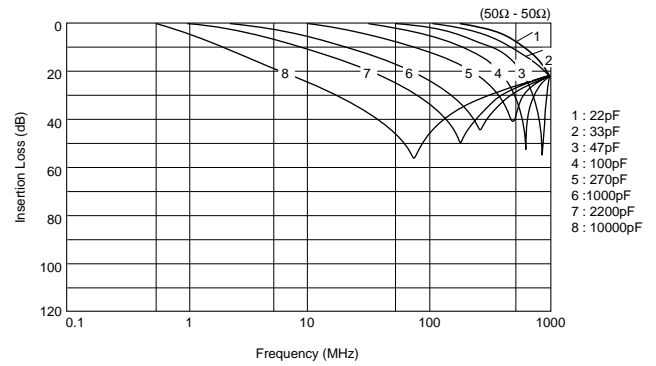

Built-in Ferrite Beads DSS6 Series Incrimp Type

Part Number	Capacitance (pF)	Rated Voltage (Vdc)	Rated Current (A)	Operating Temperature Range (°C)
DSS6NC52A220	22 +20%, -20%	100	6	-25 to 85
DSS6NC52A330	33 +20%, -20%	100	6	-25 to 85
DSS6NC52A470	47 +20%, -20%	100	6	-25 to 85
DSS6NC52A101	100 +20%, -20%	100	6	-25 to 85
DSS6NC52A151	150 +20%, -20%	100	6	-25 to 85
DSS6NC52A221	220 +20%, -20%	100	6	-25 to 85
DSS6NC52A271	270 +20%, -20%	100	6	-25 to 85
DSS6NC52A471	470 +20%, -20%	100	6	-25 to 85
DSS6NC52A102	1000 +20%, -20%	100	6	-25 to 85
DSS6NE52A222	2200 +80%, -20%	100	6	-25 to 85
DSS6NZ82A103	10000 +30%, -30%	100	6	-25 to 85
DSS6NF31C223	22000 +80%, -20%	16	6	-25 to 85

Please refer to Part Numbering for Type and Length of Lead.

■ Equivalent Circuit

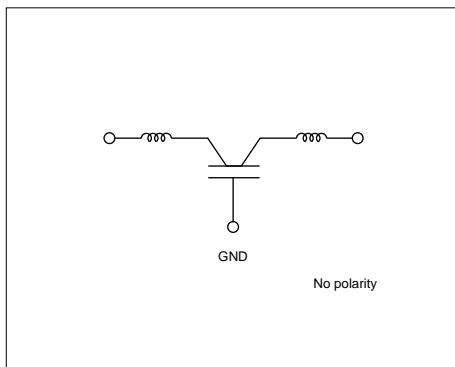

■ Insertion Loss Characteristics (Typical)

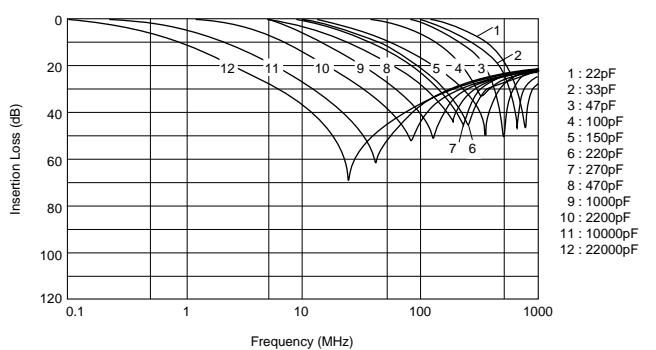

Built-in Ferrite Beads DSS6 Series Straight Type

Part Number	Capacitance (pF)	Rated Voltage (Vdc)	Rated Current (A)	Operating Temperature Range (°C)
DSS6NC52A220	22 +20%, -20%	100	6	-25 to 85
DSS6NC52A330	33 +20%, -20%	100	6	-25 to 85
DSS6NC52A470	47 +20%, -20%	100	6	-25 to 85
DSS6NC52A101	100 +20%, -20%	100	6	-25 to 85
DSS6NC52A151	150 +20%, -20%	100	6	-25 to 85
DSS6NC52A221	220 +20%, -20%	100	6	-25 to 85
DSS6NC52A271	270 +20%, -20%	100	6	-25 to 85
DSS6NC52A471	470 +20%, -20%	100	6	-25 to 85
DSS6NC52A102	1000 +20%, -20%	100	6	-25 to 85
DSS6NE52A222	2200 +80%, -20%	100	6	-25 to 85
DSS6NZ82A103	10000 +30%, -30%	100	6	-25 to 85
DSS6NF31C223	22000 +80%, -20%	16	6	-25 to 85

Please refer to Part Numbering for Type and Length of Lead.

Equivalent Circuit

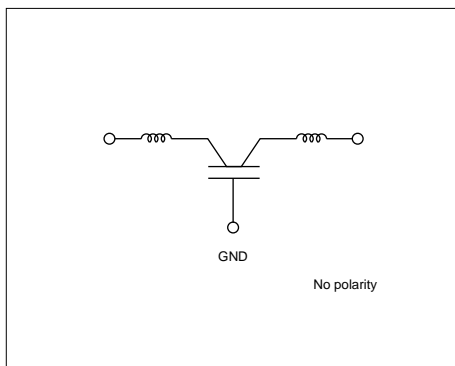

Insertion Loss Characteristics (Typical)

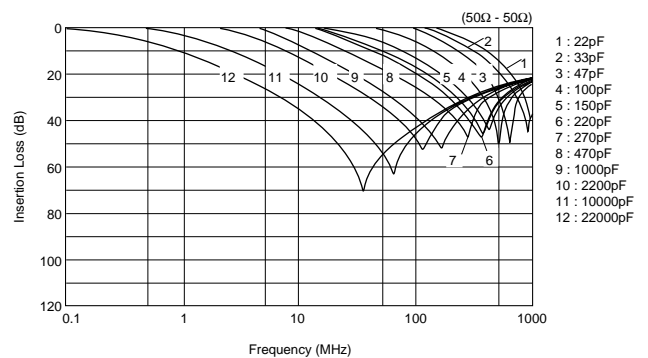

On-Board Type (DC) EMI Suppression Filters (EMIFIL®)



Disc Type EMIFIL® Broad Type DSN9/DSS9/DST9 Series

■ Features

DS_9 is a basic type EMI suppression filter which can obtain high insertion loss in a wide frequency range. Its 3-terminal structure enables nice high frequency performance. DSS9NP32A222/DSS9NT31H223 are low distortion type for audio circuits.

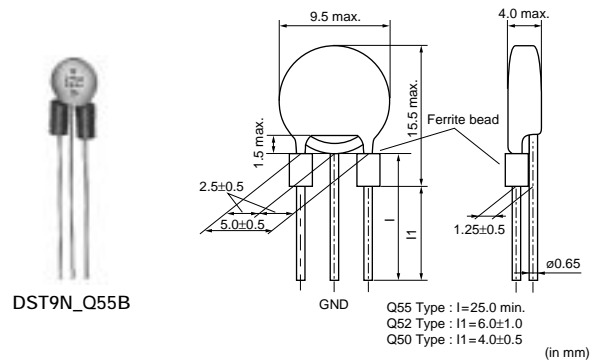
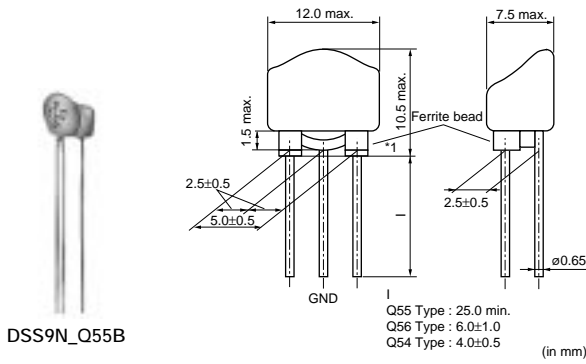
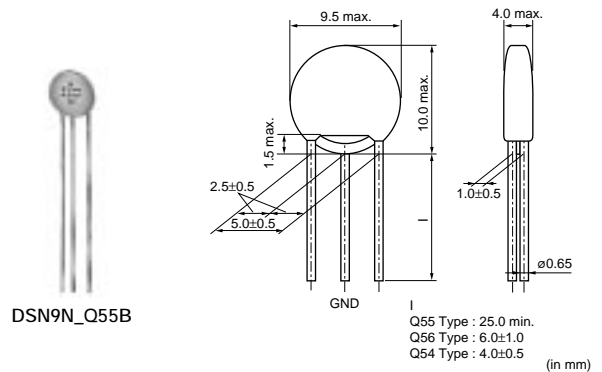

*1 Bottom of the ferrite beads may not be level with each other.

DSN9 Series

Part Number	Capacitance (pF)	Rated Voltage (Vdc)	Rated Current (A)	Operating Temperature Range (°C)
DSN9NC52A271	270 +20%,-20%	100	7	-25 to 85
DSN9NC52A222	2200 +20%,-20%	100	7	-25 to 85
DSN9NC51H223	22000 +50%,-20%	50	7	-25 to 85
DSN9NC51C104	100000 +20%,-20%	16	7	-25 to 85

Rated current is 6A for taping type.
Please refer to Part Numbering for Type and Length of Lead.

■ Equivalent Circuit

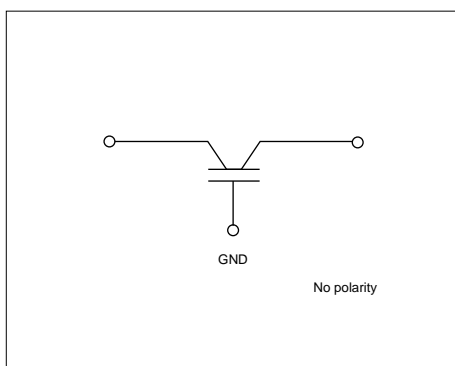

■ Insertion Loss Characteristics (Typical)

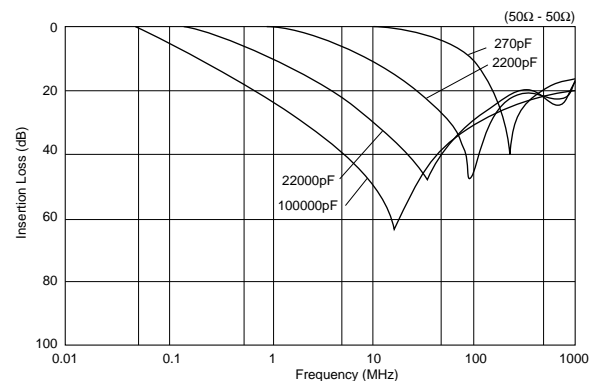

Built-in Ferrite Beads DSS9 Series

Part Number	Capacitance (pF)	Rated Voltage (Vdc)	Rated Current (A)	Operating Temperature Range (°C)
DSS9NC52A220	22 +20%, -20%	100	7	-25 to 85
DSS9NC52A470	47 +20%, -20%	100	7	-25 to 85
DSS9NC52A101	100 +20%, -20%	100	7	-25 to 85
DSS9NC52A271	270 +20%, -20%	100	7	-25 to 85
DSS9NC52A222	2200 +20%, -20%	100	7	-25 to 85
DSS9NP32A222	2200 +20%, -20%	100	7	-25 to 85
DSS9NC51H223	22000 +50%, -20%	50	7	-25 to 85
DSS9NT31H223	22000 +50%, -20%	50	7	-25 to 85

Rated current is 6A for taping type.
DSS9NP32A222/DSS9NT31H223 are low distortion types for audio IF circuits.
Please refer to Part Numbering for Type and Length of Lead.

Equivalent Circuit

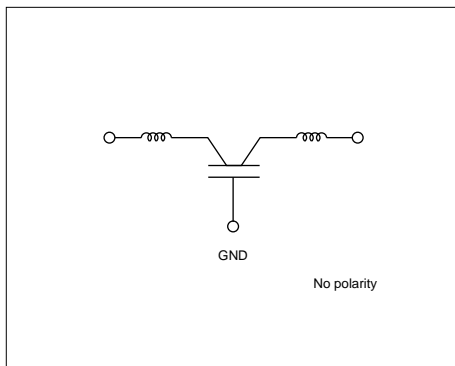

Insertion Loss Characteristics (Typical)

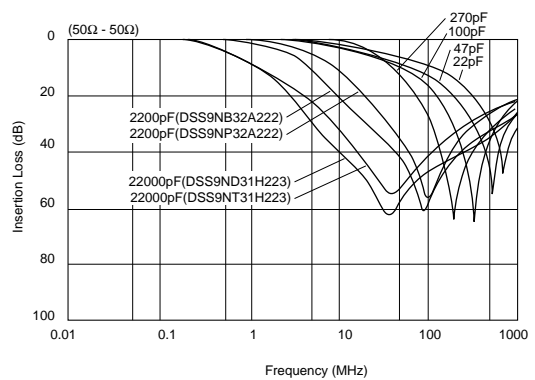

With Ferrite Beads DST9 Series

Part Number	Capacitance (pF)	Rated Voltage (Vdc)	Rated Current (A)	Operating Temperature Range (°C)
DST9NC52A271	270 +20%, -20%	100	7	-25 to 85
DST9NC52A222	2200 +20%, -20%	100	7	-25 to 85
DST9NC51H223	22000 +50%, -20%	50	7	-25 to 85

Rated current is 6A for taping type.
Please refer to Part Numbering for Type and Length of Lead.

Equivalent Circuit

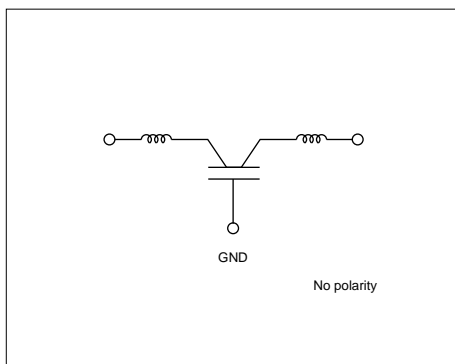

Insertion Loss Characteristics (Typical)

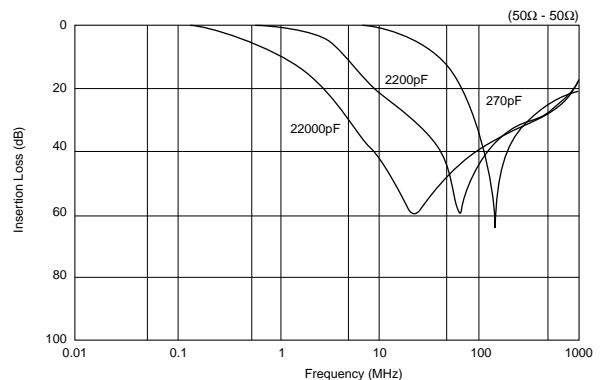

On-Board Type (DC) EMI Suppression Filters (EMIFIL®)



Disc Type EMIFIL® Heavy-duty Type DSN9H/DSS9H/DST9H Series

■ Features

DS_9H is a basic type EMI suppression filter which can obtain high insertion loss in a wide frequency range. Its three-terminal structure enables nice high frequency performance. High rated voltage of 250Vdc and wide operating temperature range from -40 degree C to 105 degree C are suitable for high reliability circuits.

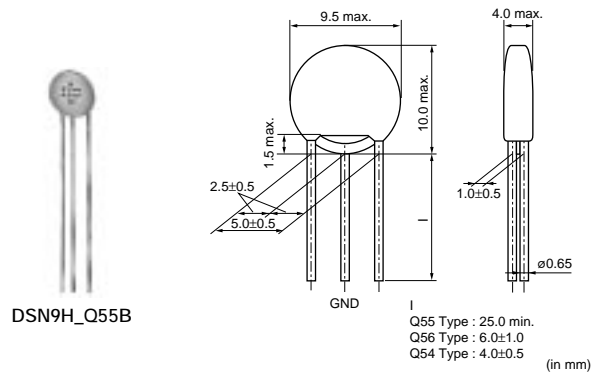

DSN9H_Q55B

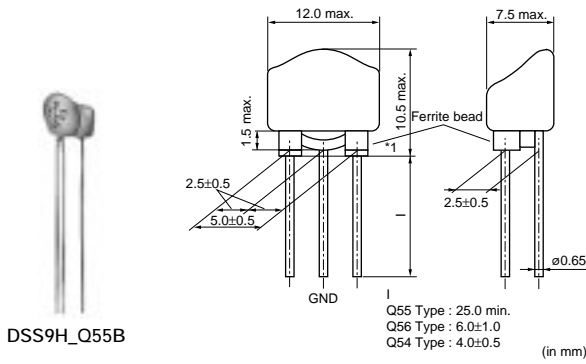

DSS9H_Q55B

*1 Bottom of the ferrite beads may not be level with each other.

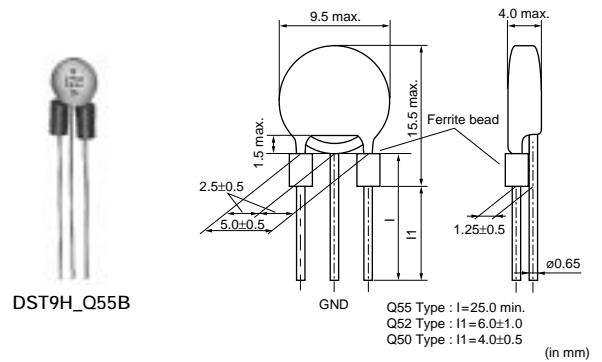

DST9H_Q55B

DSN9H Series

Part Number	Capacitance (pF)	Rated Voltage (Vdc)	Rated Current (A)	Operating Temperature Range (°C)
DSN9HB32E220	22 +20%, -20%	250	6	-40 to 105
DSN9HB32E101	100 +20%, -20%	250	6	-40 to 105
DSN9HB32E271	270 +20%, -20%	250	6	-40 to 105
DSN9HB32E222	2200 +20%, -20%	250	6	-40 to 105

Please refer to Part Numbering for Type and Length of Lead.

■ Equivalent Circuit

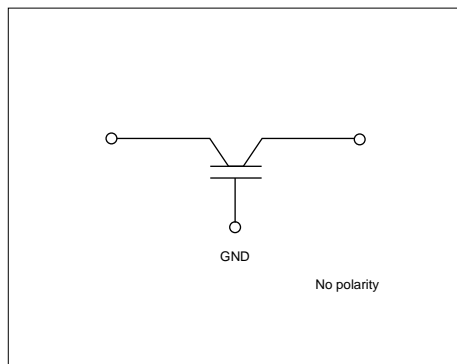

■ Insertion Loss Characteristics (Typical)

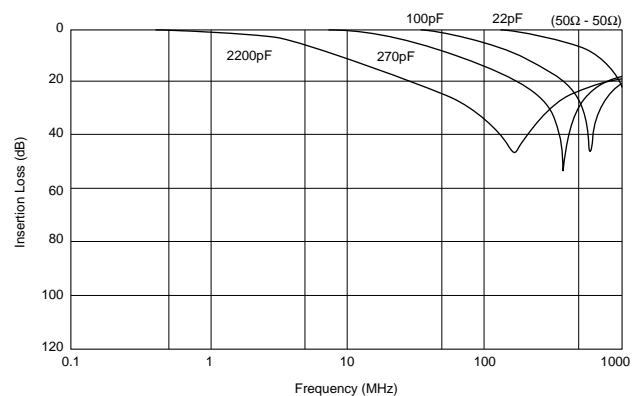

Built-in Ferrite Beads DSS9H Series

Part Number	Capacitance (pF)	Rated Voltage (Vdc)	Rated Current (A)	Operating Temperature Range (°C)
DSS9HB32E220	22 +20%,-20%	250	6	-40 to 105
DSS9HB32E101	100 +20%,-20%	250	6	-40 to 105
DSS9HB32E271	270 +20%,-20%	250	6	-40 to 105
DSS9HB32E222	2200 +20%,-20%	250	6	-40 to 105

Please refer to Part Numbering for Type and Length of Lead.

Equivalent Circuit

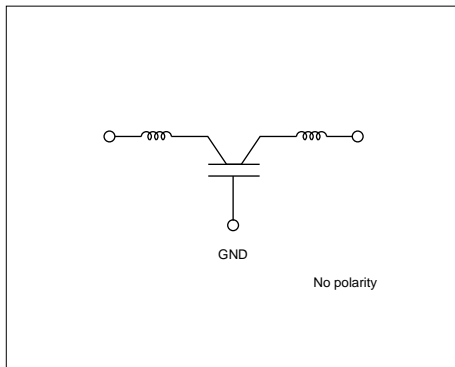

Insertion Loss Characteristics (Typical)

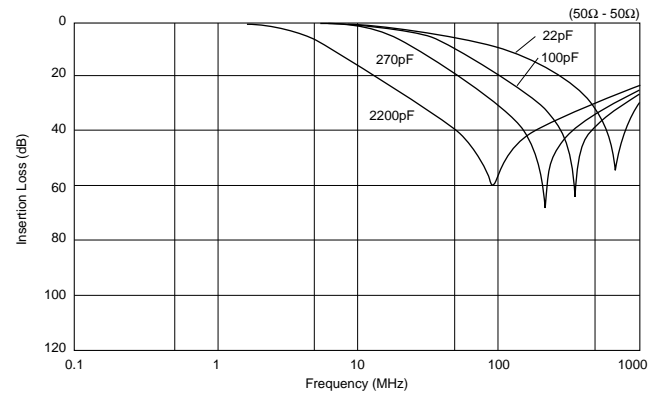

With Ferrite Beads DST9H Series

Part Number	Capacitance (pF)	Rated Voltage (Vdc)	Rated Current (A)	Operating Temperature Range (°C)
DST9HB32E220	22 +20%,-20%	250	6	-40 to 105
DST9HB32E101	100 +20%,-20%	250	6	-40 to 105
DST9HB32E271	270 +20%,-20%	250	6	-40 to 105
DST9HB32E222	2200 +20%,-20%	250	6	-40 to 105

Please refer to Part Numbering for Type and Length of Lead.

Equivalent Circuit

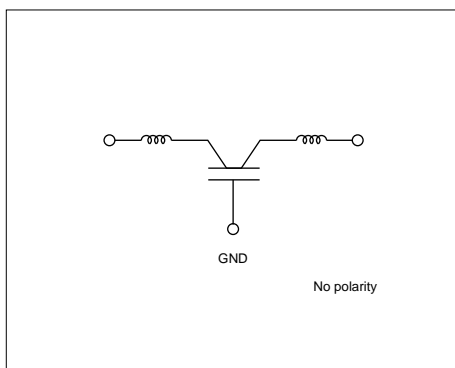

Insertion Loss Characteristics (Typical)

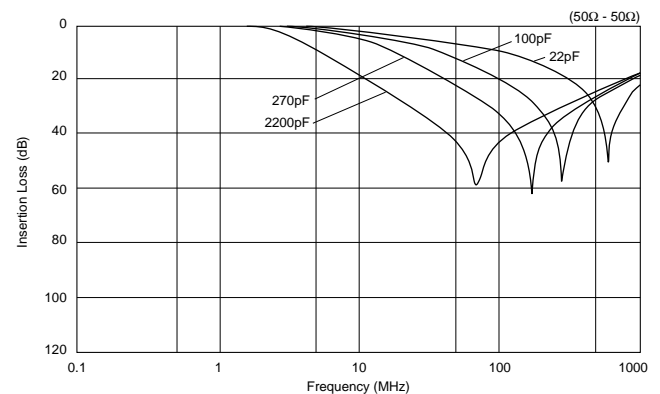

On-Board Type (DC) EMI Suppression Filters (EMIFIL[®])



Lead Type EMIGUARD[®] (EMIFIL[®] with Varistor Function) Part Numbering

Lead Type EMIGUARD[®] (EMIFIL[®] with Varistor Function)

(Global Part Number) **VF** **S** **6** **V** **D8** **1E** **221** **T51** **B**
① ② ③ ④ ⑤ ⑥ ⑦ ⑧ ⑨

① Product ID

Product ID	
VF	EMIGUARD [®] Lead Type

② Structure

Code	Structure
S	Built-in Ferrite Beads Type
R	with Resistance

③ Style

Code	Style
3	Size is expressed by a figure
6	
9	

④ Features

Code	Features
V	with Varistor Function

⑤ Temperature Characteristics

Code	Capacitance Change
D8	+20/-30% (Temperature Range : -40°C~+105°C)
D3	+20/-30% (Temperature Range : -25°C~+85°C)

⑥ Rated Voltage

Code	Rated Voltage
1E	25V
1B	12V

⑦ Capacitance

Expressed by three figures. The unit is in pico-farad (pF). The first and second figures are significant digits, and the third figure expresses the number of zeros which follow the two figures.

⑧ Lead Type/⑨ Packaging

Code	Lead Type	Lead Length*	Packaging	Series
T51B	Incrimp	25.0mm min.	Bulk	VFR3/VFS6
U31A		18.5+/-1.0mm	Ammo Pack	
Q55B	Straight	25.0mm min.	Bulk	VFS9
Q91J		20.0+/-1.0mm	Paper Reel (ø320mm)	
Q92J		16.5+/-1.0mm		
Q93J		18.5+/-1.0mm		

*Lead Distance between Reference and Bottom Planes except Bulk.

On-Board Type (DC) EMI Suppression Filters (EMIFIL®)



Lead Type EMIGUARD® (EMIFIL® with Varistor Function) VFR3V/VFS6V/VFS9V Series

for Semiconductor Protection VFR3V Series

■ Features

The VFR3V series is designed for ESD surge protection of IC. It efficiently absorbs ESD surges rushed into IC's I/O terminals.

■ Applications

Elimination of noise and protection of semiconductors in office equipment, including computers and peripheral equipment, copy machines, and communication terminals.

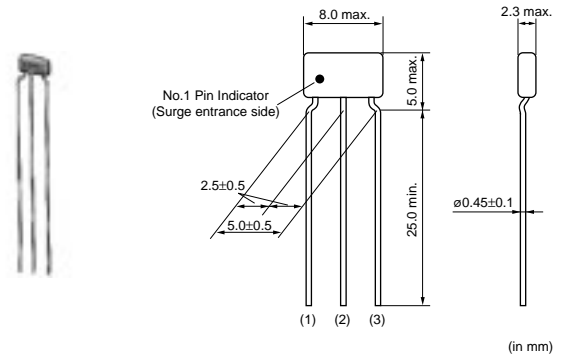

Part Number	Rated Voltage (Vdc)	Varistor Voltage (Vdc)	Capacitance (pF)	Rated Current (mA)	Peak Pulse Current (A)	Operating Temperature Range (°C)
VFR3VD31E131	25	50 +20%,-20%	130 +20%,-20%	20	15	-25 to 85

Please refer to Part Numbering for Type and Length of Lead.

■ Insertion Loss Characteristics

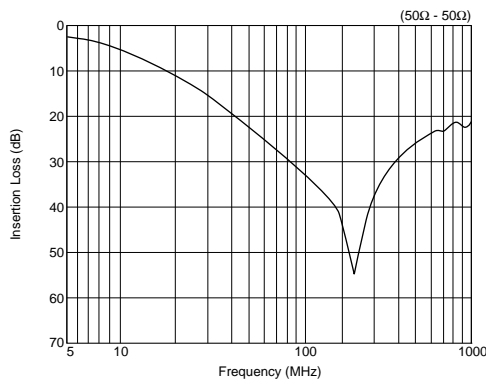

for Signal-Line VFS6V Series

■ Features

The VFS6V series is designed for surge protection of signal line. It protects electric circuit from surges such as static electricity and suppresses EMI noise. Built-in ferrite bead gives excellent EMI suppression.

■ Applications

Elimination of noise and protection of electric circuits in office equipment, including computers and peripheral equipment, copy machines, and communication terminals.

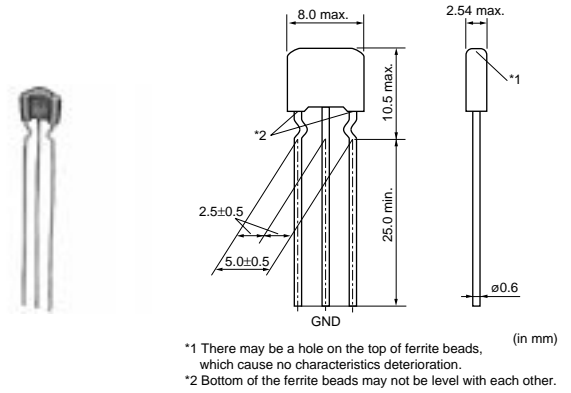

Part Number	Rated Voltage (Vdc)	Varistor Voltage (Vdc)	Capacitance (pF)	Rated Current (A)	Peak Pulse Current (A)	Operating Temperature Range (°C)
VFS6VD81E221	25	50 +20%,-20%	220 +20%,-20%	6	100	-40 to 105

Please refer to Part Numbering for Type and Length of Lead.

■ Insertion Loss Characteristics

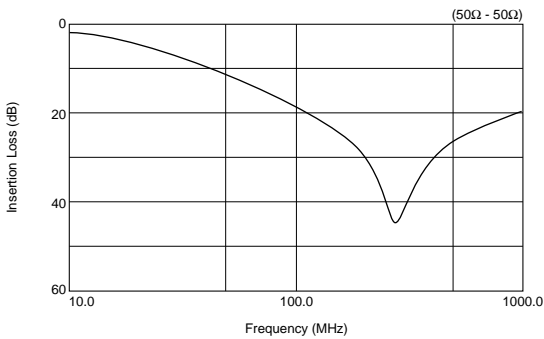

for Large-Current VFS9V Series

■ Features

The VFS9V series is designed for surge protection of the power supply line. It protects electric circuits from surges such as static electricity and suppresses EMI noise. Its large capacitance value enables high insertion loss for EMI noise.

■ Applications

For circuit protection and noise suppression in electronics equipment such as computers and DC motors, and in electronics systems installed in cars such as car audio equipment and engine controllers.

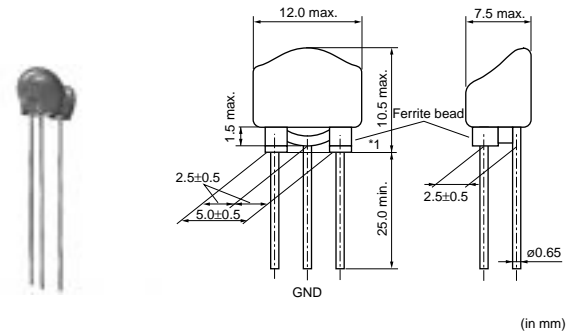

*1 Bottom of the ferrite beads may not be level with each other.

Part Number	Rated Voltage (Vdc)	Varistor Voltage (Vdc)	Capacitance (pF)	Rated Current (A)	Operating Temperature Range (°C)
VFS9VD31B223	12	22 +20%,-20%	22000 +50%,-20%	7	-40 to 100

Rated current: 6A (Taping Type)/7A (Bulk Type)
Please refer to Part Numbering for Type and Length of Lead.

■ Insertion Loss Characteristics

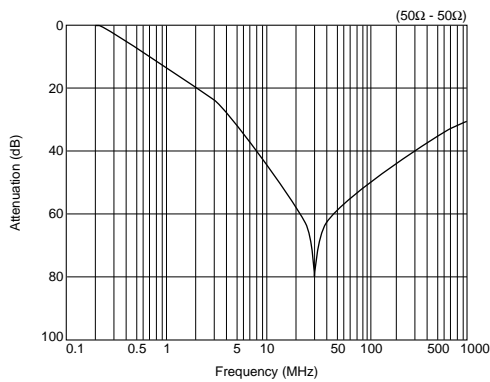

■ Voltage-Current Characteristics

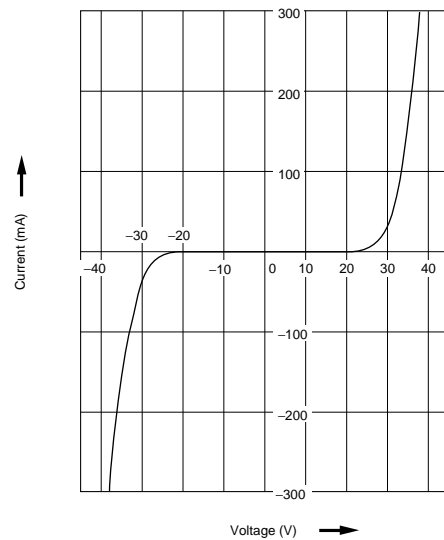

Noise Suppression Effect of VFR/VFS Series

■ Example of IC Protection

● Testing Method

1. Put ESD surge to IC (7404 family) input terminal with ESD simulator based on IEC 801-2.
2. Check IC's operation.
3. If IC's operation is normal, increase ESD voltage in 1kV step.
4. Continue above steps 1 to 3 till IC's operation becomes abnormal.

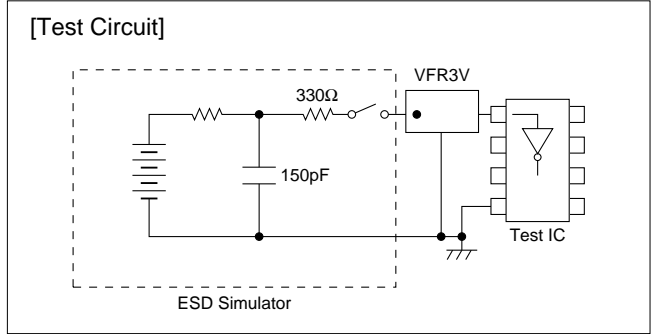

● Result

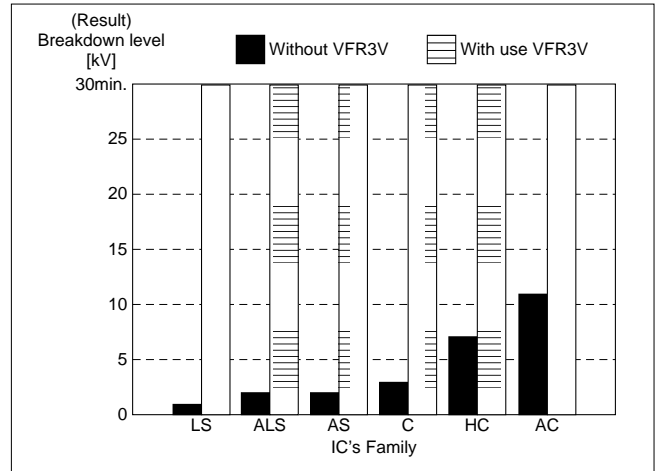

■ Example of EMI Suppression Effect

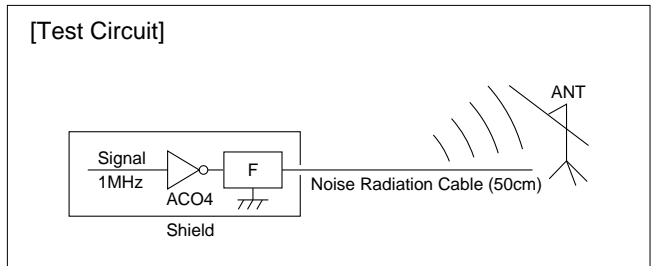

Type of Filter	EMI Suppression Effect	Description
Before Countermeasures (No Filters)		
Use VFR3VD31E131T51		

Noise Suppression Effect of VFR/VFS Series

■Features (VFS9V)

Items	Test methods	Rated values										
Overload	1.4 times the varistor voltage (V_1) is applied for 5 minutes at room temperature.	<table border="1"> <thead> <tr> <th>Items</th> <th>Specifications</th> </tr> </thead> <tbody> <tr> <td>Rated Capacitance Change</td> <td>Within $\pm 15\%$</td> </tr> <tr> <td>Insulation Resistance</td> <td>500kΩ min</td> </tr> <tr> <td>Rated of Change in Varistor Voltage V_1^*</td> <td>Within $\pm 15\%$</td> </tr> <tr> <td>Voltage Rate</td> <td>1.30 max</td> </tr> </tbody> </table> <p>*V_1 : Voltage when 1mA is applied</p>	Items	Specifications	Rated Capacitance Change	Within $\pm 15\%$	Insulation Resistance	500k Ω min	Rated of Change in Varistor Voltage V_1^*	Within $\pm 15\%$	Voltage Rate	1.30 max
Items	Specifications											
Rated Capacitance Change	Within $\pm 15\%$											
Insulation Resistance	500k Ω min											
Rated of Change in Varistor Voltage V_1^*	Within $\pm 15\%$											
Voltage Rate	1.30 max											
Surge Test (1)	At room temperature. Surges are applied are 10^5 times every 2 seconds. Then after 1 or 2 hours, the sample is measured.	<table border="1"> <thead> <tr> <th>Items</th> <th>Specifications</th> </tr> </thead> <tbody> <tr> <td>Rated Capacitance Change</td> <td>Within $\pm 15\%$</td> </tr> <tr> <td>Insulation Resistance</td> <td>500kΩ min</td> </tr> <tr> <td>Rated of Change in Varistor Voltage V_1^*</td> <td>Within $\pm 15\%$</td> </tr> <tr> <td>Voltage Rate</td> <td>1.30 max</td> </tr> </tbody> </table> <p>*V_1 : Voltage when 1mA is applied</p>	Items	Specifications	Rated Capacitance Change	Within $\pm 15\%$	Insulation Resistance	500k Ω min	Rated of Change in Varistor Voltage V_1^*	Within $\pm 15\%$	Voltage Rate	1.30 max
Items	Specifications											
Rated Capacitance Change	Within $\pm 15\%$											
Insulation Resistance	500k Ω min											
Rated of Change in Varistor Voltage V_1^*	Within $\pm 15\%$											
Voltage Rate	1.30 max											
Surge Test (2)	At room temperature. Capacitor "C" is charged with 70V, then discharged to apply the voltage to the sample. Tested once (resuming JASO A-1).	<table border="1"> <thead> <tr> <th>Items</th> <th>Specifications</th> </tr> </thead> <tbody> <tr> <td>Rated Capacitance Change</td> <td>Within $\pm 15\%$</td> </tr> <tr> <td>Insulation Resistance</td> <td>500kΩ min</td> </tr> <tr> <td>Rated of Change in Varistor Voltage V_1^*</td> <td>Within $\pm 15\%$</td> </tr> <tr> <td>Voltage Rate</td> <td>1.30 max</td> </tr> </tbody> </table> <p>*V_1 : Voltage when 1mA is applied</p>	Items	Specifications	Rated Capacitance Change	Within $\pm 15\%$	Insulation Resistance	500k Ω min	Rated of Change in Varistor Voltage V_1^*	Within $\pm 15\%$	Voltage Rate	1.30 max
Items	Specifications											
Rated Capacitance Change	Within $\pm 15\%$											
Insulation Resistance	500k Ω min											
Rated of Change in Varistor Voltage V_1^*	Within $\pm 15\%$											
Voltage Rate	1.30 max											
High Temperature Load	At a temperature of $85 \pm 3^\circ\text{C}$. The varistor voltage V_1 is continuously applied to the sample for 1000 to 1024 hours. Then it is left at room temperature, for 4 to 24 hours before measuring.	<table border="1"> <thead> <tr> <th>Items</th> <th>Specifications</th> </tr> </thead> <tbody> <tr> <td>Rated Capacitance Change</td> <td>Within $\pm 15\%$</td> </tr> <tr> <td>Insulation Resistance</td> <td>500kΩ min</td> </tr> <tr> <td>Rated of Change in Varistor Voltage V_1^*</td> <td>Within $\pm 15\%$</td> </tr> <tr> <td>Voltage Rate</td> <td>1.30 max</td> </tr> </tbody> </table> <p>*V_1 : Voltage when 1mA is applied</p>	Items	Specifications	Rated Capacitance Change	Within $\pm 15\%$	Insulation Resistance	500k Ω min	Rated of Change in Varistor Voltage V_1^*	Within $\pm 15\%$	Voltage Rate	1.30 max
Items	Specifications											
Rated Capacitance Change	Within $\pm 15\%$											
Insulation Resistance	500k Ω min											
Rated of Change in Varistor Voltage V_1^*	Within $\pm 15\%$											
Voltage Rate	1.30 max											

■Pulse-Voltage Breakdown Characteristic (VFS9V)

The VFS9V EMIGUARD[®] use a self healing varistor-capacitor, so that it can be used under a 500 to 600V surge which would break conventional disk type EMI filters. As shown in figure below the EMIGUARD[®] withstands 2000V impulses applied 1000 times.

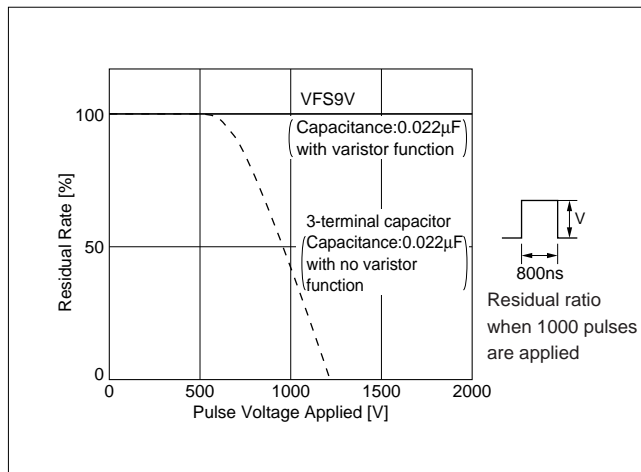
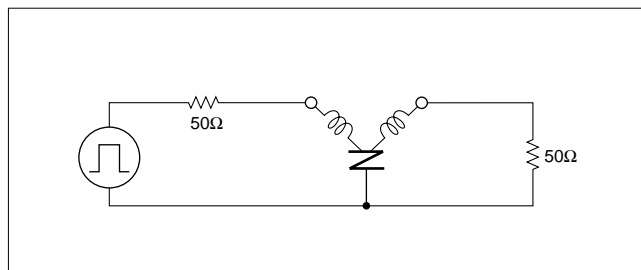

■Temperature Characteristics of Varistor Voltage-Insulation Resistance (VFS9V)

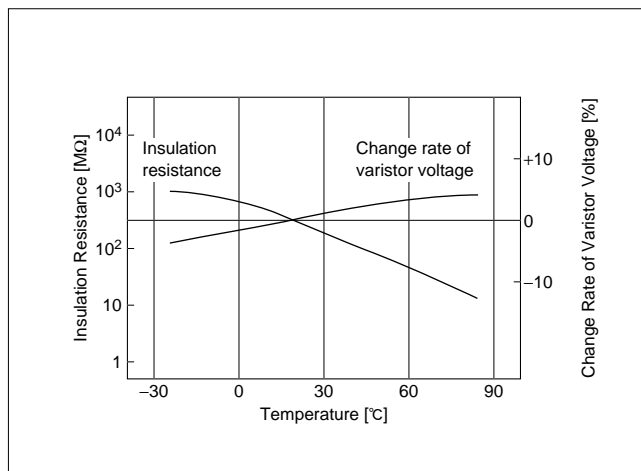

Continued on the following page. ↗

Noise Suppression Effect of VFR/VFS Series



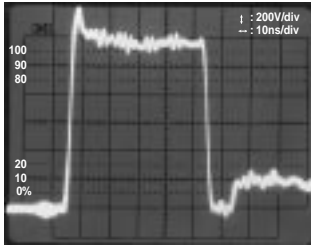
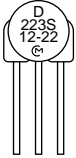
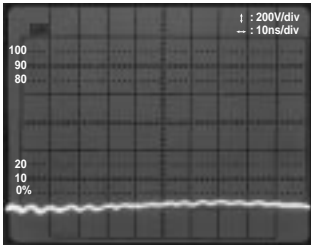

Continued from the preceding page.

■ Noise Absorption Effect of EMIGUARD®

Type of Filter	EMI Suppression Effect	Description
without EMIGUARD®		Waveform when EMIGUARD® is not used. (Surge from a noise simulator)
with EMIGUARD® 		Waveform after the noise passed through EMIGUARD®. Little noise is recorded.

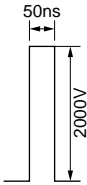
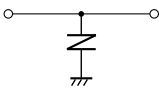
■ Comparative Data

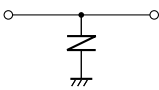
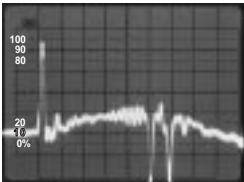
1. Absorption of quick-rising, high-frequency noise (10ns/div, 100V/div)

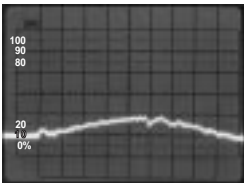
Type of Filter	EMI Suppression Effect	Description
without Filters	 Noise wave applied	
Conventional varistor 		As with the 2-terminal capacitor
2-terminal capacitor (with varistor function) 		The 2-terminal capacitor is influenced by lead line inductance, leaving behind some of the rising and falling edges. The residual noise can cause the system to malfunction.
VFS9V 		The 3-terminal structure eliminates most of the lead line inductance. This allows the VFS9V to completely absorb the rising and falling edges of the applied pulses.

Continued on the following page. 

Noise Suppression Effect of VFR/VFS Series

☐ Continued from the preceding page.

2. Absorption of wide-pulse noise (50ns/div, 200V/div)

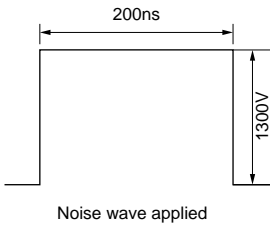
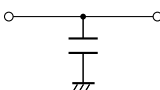
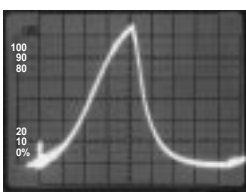
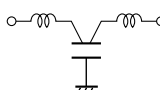
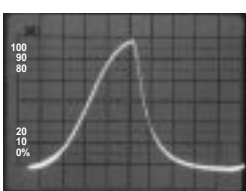
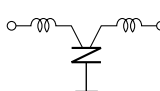
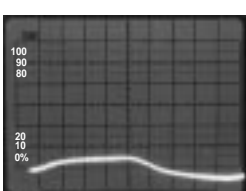
Type of Filter	EMI Suppression Effect	Description
without Filters	 <p>Noise wave applied</p>	
2-terminal capacitor 		In capacitors the voltage of the residual surge (1300V) is higher than that of the above example. The wave height is almost the same as the original.
3-terminal capacitor (with ferrite bead) 		Conventional EMI filters do not work for wide-pulse noise because capacitors are saturated. In this example, the residual 1200V surge can cause the system to breakdown.
VFS9V 		Bypassing the high voltage to the ground, voltage can be suppressed.

On-Board Type (DC) EMI Suppression Filters (EMIFIL®)



Block Type EMIFIL® BNX Series

BNX Series

The block type "EMIFIL" BNX series incorporates through-type capacitor, monolithic chip capacitors and bead. The BNX is high performance for use in DC power circuits.

■ Features

1. The filter enables obtaining high insertion loss in wide frequency ranges from 0.5MHz to 1GHz.
2. The only one filter block enables noise suppression of both the positive and negative lines.
3. There are no connection routes in the current circuits, thus ensuring highly reliable performance.

■ Applications

Noise elimination from DC power sources in a variety of switching power sources, engine control units, digital equipment and computer terminals.

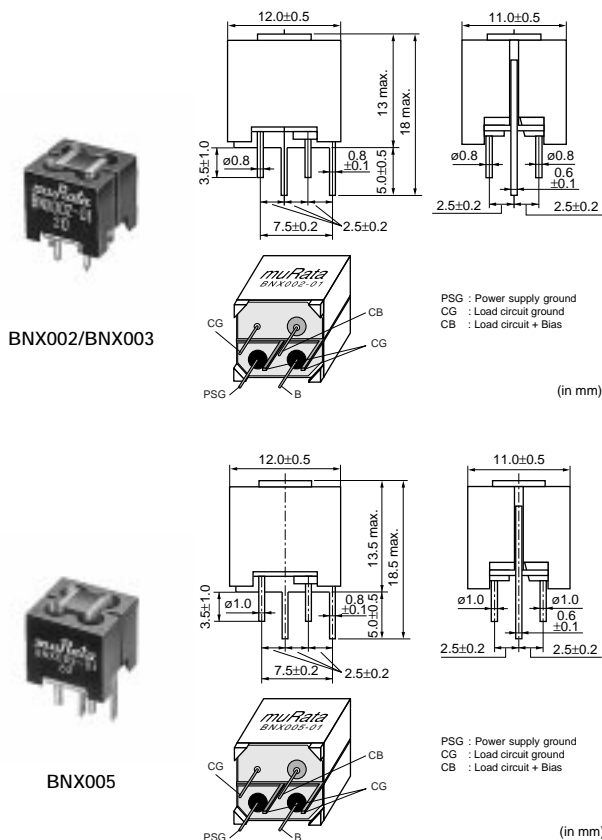

Part Number	Rated Voltage (Vdc)	Withstand Voltage (Vdc)	Rated Current (A)	Insulation Resistance (min.) (M ohm)	Insertion Loss
BNX002-01	50	125	10	100	1MHz to 1GHz:40dB min.(20 to 25°C line impedance=50 ohm)
BNX003-01	150	375	10	100	5MHz to 1GHz:40dB min.(20 to 25°C line impedance=50 ohm)
BNX005-01	50	125	15	100	1MHz to 1GHz:40dB min.(20 to 25°C line impedance=50 ohm)

Operating Temperature Range : -30°C to 85°C

■ Equivalent Circuit

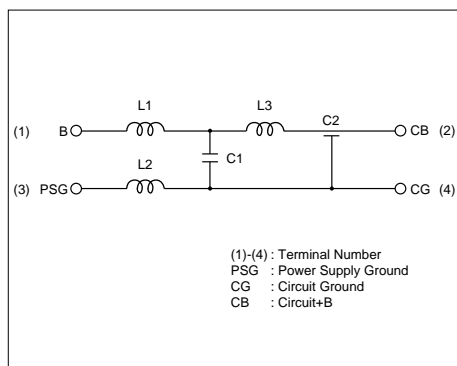

■ Insertion Loss Characteristics (Typical)

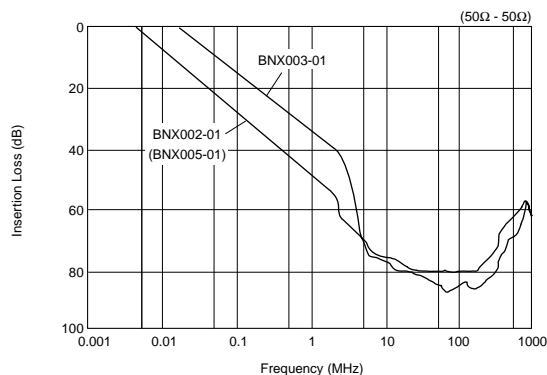

Noise Suppression Effect of BNX Series

■ Suppression of DC Side Ripple of the Switching Power Supply

[Testing Circuit]

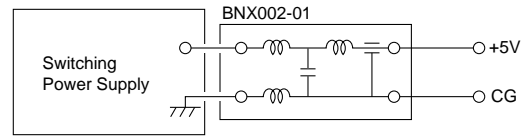

Type of Filter	EMI Suppression Effect	Description
When BNX002 is not used	<p>+5.0V → 50μs/div 0.2V/div</p>	High frequency noise, max. 0.5V, can be seen.
When BNX002 is used	<p>+5.0V → 50μs/div 0.2V/div</p>	Noise can be almost suppressed by BNX002.

On-Board Type (DC) EMI Suppression Filters (EMIFIL®)



Common Mode Choke Coils Part Numbering

Common Mode Choke Coils

(Global Part Number) **PL T 09 H N 200 3R0 P 1 B**
① ② ③ ④ ⑤ ⑥ ⑦ ⑧ ⑨ ⑩

① Product ID

Product ID	
PL	Common Mode Choke Coils

② Type

Code	Type
T	DC Type

③ Applications

Code	Applications
09	for DC Line High-frequency Type

④ Structure

Code	Structure
H	Core Horizontal Type

⑤ Features

Code	Features
N	General Use

⑥ Inductance

Expressed by three figures. The unit is micro-henry (μH). The first and second figures are significant digits, and the third figure expresses the number of zeros which follow the two figures. If there is a decimal point, it is expressed by the capital letter "R". In this case, all figures are significant digits. If inductance is less than 0.1 μH, the inductance code is expressed by a combination of two figures and the capital letter "N", and the unit of inductance is nano-henry (nH). The capital letter "N" indicates the unit of "nH", and also expresses a decimal point. In this case, all figures are significant digits.

⑦ Rated Current

Expressed by three figures. The unit is in amperes (A). A decimal point is expressed by the capital letter "R". In this case, all figures are significant digits.

⑧ Winding Mode

Code	Winding Mode
P	Aligned Winding Type

⑨ Lead Dimensions

Code	Lead Dimensions
1	5mm

⑩ Packaging

Code	Packaging	Series
B	Bulk	All series

On-Board Type (DC) EMI Suppression Filters (EMIFIL®)



Common Mode Choke Coils (for DC Line) PLT09H Series

The PLT09H series is common mode choke coil for DC line. It is effective against the common mode noise that can cause radiative noise in power supply lines and interface lines. The additional normal mode inductance enables high suppression effect to radiation noise.

■ Features

1. This is a wide frequency range type, applicable in applications ranging from a few MHz to several 100MHz.
2. It features a low-profile design.

■ Applications

1. Noise suppression of SW power supply, DC-DC converter.
2. DC power lines in AC adapter of Portable equipment.

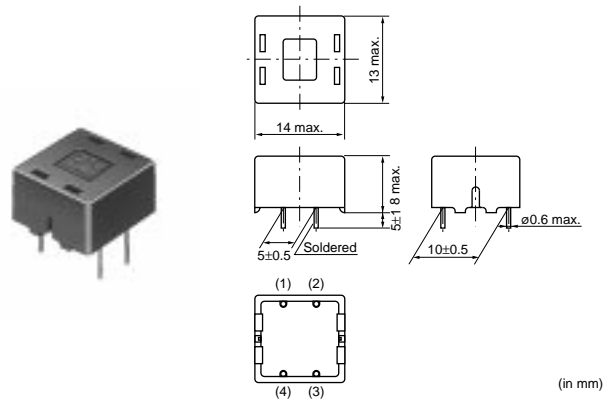

Part Number	Common Mode Inductance (μH)	Rated Current (A)	Rated Voltage (Vdc)	Withstand Voltage (Vdc)
PLT09HN2003R0P1	20 min.	3	50	125

Operating Temperature Range : -40°C to 85°C

■ Equivalent Circuit

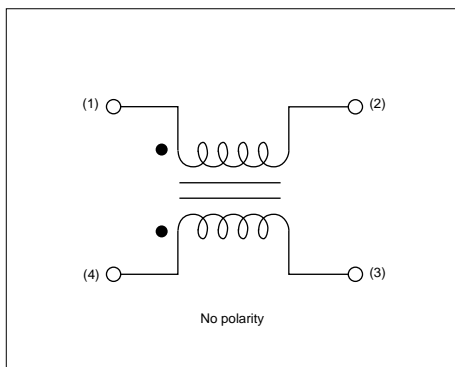

■ Insertion Loss Characteristics (Typical)

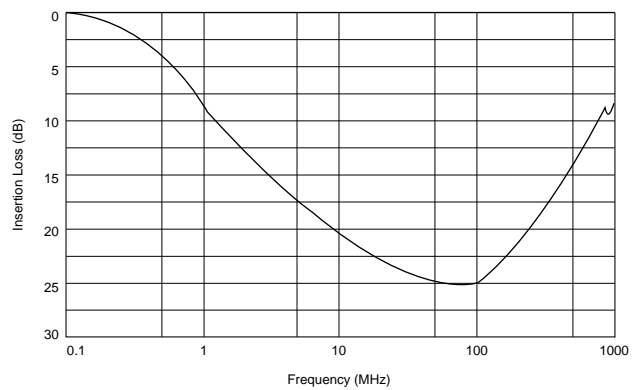

On-Board Type (DC) EMI Suppression Filters (EMIFIL®)



Microwave Absorbers Part Numbering

Microwave Absorber

(Global Part Number) **EA** **1026** **A** **160** **M** **200** **200**
① ② ③ ④ ⑤ ⑥ ⑦

① Product ID

Product ID	
EA	Microwave Absorber

② Sheet Type

Code	Sheet Type
10 □□	Iron carbonyl type
2070	Metal Flake Powder (non Halogen type)
2100	Metal Flake Powder (UL certified type)

③ Adhesive Tape Type

Code	Adhesive Tape Type
A	Standard tape type
B	Thin Adhesive tape type
L	No tape type
U	UL certified type

④ Sheet Thickness

Expressed by 3 digits including the second decimal place in mm.

Ex.)

Code	Sheet Thickness
020	0.20mm

⑤ Unit of Dimension

One capital letter expresses Unit of dimension (⑤) and Dimensions Length (⑦).

Code	Unit of Dimension
M	in mm (Standard)
C	in cm (Standard)

Standard shape is a rectangle.
Please contact us for other shapes.

⑥ Dimension (Length)

Expressed by 3 digits including the first decimal place.

⑦ Dimension (Width)

Expressed by 3 digits including the first decimal place.

Ex.)

Code	Dimension (Length × Width)
M300150	30.0×15.0 mm
C150100	15.0×10.0 cm

On-Board Type (DC) EMI Suppression Filters (EMIFIL®)



Microwave Absorbers EA10/EA20/EA21 Series

EA10 Series

■ Features

1. Excellent elasticity and durability with silicon rubber.
2. Suitable for prevention of abnormal oscillation in high frequency modules, suppression of spurious spectra and prevention interference between circuits.
3. Holds easily in equipment with adhesive tape.

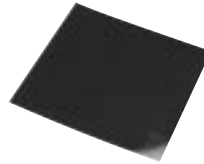

Part Number	Applicable Frequency	Thickness (mm)	Flame Resistance	Halogen	Operating Temperature Range
EA1026A100	20.0 GHz (Typ.)	1.0 (Typ.)	-	Halogen Free	-40 to +80 °C
EA1026A160	11.5 GHz (Typ.)	1.6 (Typ.)	-	Halogen Free	-40 to +80 °C
EA1026A180	10.0 GHz (Typ.)	1.8 (Typ.)	-	Halogen Free	-40 to +80 °C
EA1046A180	5.8 GHz (Typ.)	1.8 (Typ.)	UL94V-0	Halogen Free	-40 to +80 °C
EA1075A270	2.5 GHz (Typ.)	2.7 (Typ.)	UL94V-0	Halogen Free	-40 to +80 °C

■ Refraction Loss

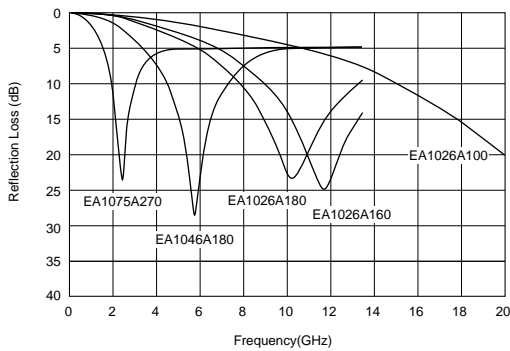

EA20/21 Series

■ Features

1. Magnetically-shielded high-micro and high-loss characteristics can suppress noise in a wide frequency band for digital equipment.
2. Thin (0.2mm-1.0mm) and flexible sheet makes easy handling in assembly process.
3. Holds easily in equipment with adhesive tape.
4. EA20xx series : Non Halogen type
EA21xx series : UL94V-0 certified material is used.



Part Number	Applicable Frequency	Thickness (mm)	Flame Resistance	Halogen	Operating Temperature Range
EA2070A020	0.1 - 3.0GHz (Typ.)	0.2 (Typ.)	-	Halogen Free	-40 to +105 °C
EA2070A050	0.1 - 3.0 GHz (Typ.)	0.5 (Typ.)	-	Halogen Free	-40 to +105 °C
EA2070A100	0.1 - 3.0 GHz (Typ.)	1.0 (Typ.)	-	Halogen Free	-40 to +105 °C
EA2070B005	0.1 - 3.0 GHz (Typ.)	0.05 (Typ.)	-	Halogen Free	-40 to +105 °C
EA2070B010	0.1 - 3.0 GHz (Typ.)	0.10 (Typ.)	-	Halogen Free	-40 to +105 °C
EA2070B013	0.1 - 3.0 GHz (Typ.)	0.13 (Typ.)	-	Halogen Free	-40 to +105 °C
EA2070B020	0.1 - 3.0 GHz (Typ.)	0.2 (Typ.)	-	Halogen Free	-40 to +105 °C
EA2070B050	0.1 - 3.0 GHz (Typ.)	0.5 (Typ.)	-	Halogen Free	-40 to +105 °C
EA2100A020	0.1 - 3.0 GHz (Typ.)	0.2 (Typ.)	UL94V-0	-	-40 to +105 °C
EA2100A050	0.1 - 3.0 GHz (Typ.)	0.5 (Typ.)	UL94V-0	-	-40 to +105 °C
EA2100A100	0.1 - 3.0 GHz (Typ.)	1.0 (Typ.)	UL94V-0	-	-40 to +105 °C
EA2100B020	0.1 - 3.0 GHz (Typ.)	0.2 (Typ.)	UL94V-0	-	-40 to +105 °C
EA2100B050	0.1 - 3.0 GHz (Typ.)	0.5 (Typ.)	UL94V-0	-	-40 to +105 °C
EA2100B100	0.1 - 3.0 GHz (Typ.)	1.0 (Typ.)	UL94V-0	-	-40 to +105 °C

■ Magnetic Permeability-Reluctance (Typical)

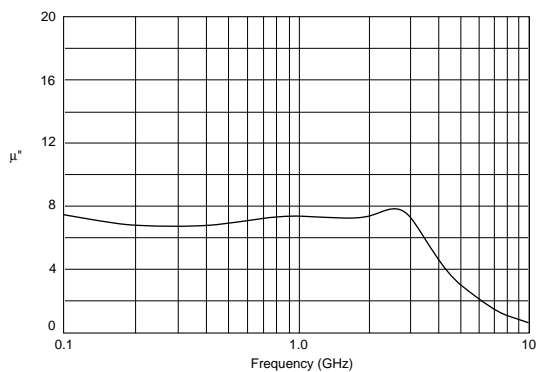

Chip EMIFIL® ⚠Caution/Notice

■ ⚠Caution (Soldering and Mounting)

Give special attention when mounting chip "EMIFIL" BLM_P/NFM_P series close to other products that radiate heat. The excessive heat by other products may cause deterioration of the insulation resistance and result in excessive heat or fire.

■ Notice (Storage and Operating Conditions)

< Operating Environment >

Do not use products in a chemical atmosphere such as chlorine gas, acid or sulfide gas.

< Storage and Handling requirements >

1. Storage Period

BLM/BLA/VFM41R/DLP31S/DLM2HG series should be used within 6 months, the other series should be used within 12 months. Solderability should be

checked if this period is exceeded.

2. Storage conditions

(1) Storage temperature : -10 to 40 degree C

Relative humidity : 30 to 70%

Avoid sudden changes in temperature and humidity.

(2) Do not store products in a chemical atmosphere such as chlorine gas, acid or sulfide gas.

■ Notice (Rating)

Noise suppression levels resulting from MURATA's EMI suppression filters "EMIFIL" may vary, depending on the circuits and ICs used, type of noise, mounting pattern, lead wire length, mounting location, and other operating conditions. Be sure to check and confirm in advance the noise suppression effect of each filter, in actual circuits, etc. before applying the filter in a commercial-purpose equipment design.

■ Notice (Soldering and Mounting)

< Operating Environment >

Do not use products in a chemical atmosphere such as chlorine gas, acid or sulfide gas.

< Storage and Handling requirements >

1. Storage Period

Products inspected by Murata over 12 months ago should be examined prior to use. Date can be confirmed with inspection No. marked on the container.

Solderability should be checked if this period is

exceeded. (NFM41P/55P, VCM series should be used within 6 months.)

2. Storage conditions

(1) Storage temperature : -10 to 40 C.

Relative humidity : 30 to 70%

Avoid sudden changes in temperature and humidity.

(2) Do not store products in a chemical atmosphere such as chlorine gas, acid or sulfide gas.

Lead Type EMIFIL® ⚠Caution/Notice

■ ⚠Caution (Rating)

Do not use products beyond the rated current and the rated voltage, or deterioration of the insulation resistance may result in excessive heat or fire.

■ ⚠Caution (Soldering and Mounting)

Mounting holes should be designed as specified in these specifications. Other design than shown in these specifications may cause cracks in ceramics which may lead to smoking or firing.

■ Notice (Storage and Operation Condition)

< Operating Environment >

1. Do not use products in a chemical atmosphere such as chlorine gas, acid or sulfide gas.
2. Do not use products near water, oil or organic solvents. Avoid environment where dust or dirt may adhere to product.

< Concerned to "EMIGUARD" >

VFR3V series is designed only to absorb electro-static surges. Do not use this product to absorb large energy surges such as lightning or switching related surges.

< Storage and Handling Requirements >

1. Storage Period

Use the products within 12 months after delivery;

solderability should be checked if this period is exceeded.

2. Storage conditions

- (1) Storage temperature : -10 to 40 degree C

Relative humidity : 30 to 70%

Avoid sudden changes in temperature and humidity.

- (2) Do not store products in a chemical atmosphere such as chlorine gas, acid or sulfide gas.
- (3) When restoring taping type (BL01RN1R1F1J), please attach the Spacer between flanges of reel. The Spacer is corrugated paper which is attached when shipping.

■ Notice (Rating)

Noise suppression levels resulting from MURATA's EMI suppression filters "EMIFIL" may vary, depending on the circuits and ICs used, type of noise, mounting pattern, lead wire length, mounting location, and other operating conditions. Be sure to check and confirm in advance the noise suppression effect of each filter, in actual circuits, etc. before applying the filter in a commercial-purpose equipment design.

EMIFIL® (Soldering and Mounting)

1. Standard Land Pattern Dimensions

The capacitor type Chip EMIFIL® (NF□ series) / Chip EMIGUARD® (VFM series) suppress noise by conducting the high-frequency noise element to ground. Therefore, to obtain maximum performance from these filters, the ground pattern should be made as large as possible during the PCB design stage. As shown in the right, one side of the PCB is used for chip mounting, and the other is used for grounding.

Small diameter feedthrough holes are then used to connect the grounds on each side of the PCB. This reduces the high-frequency impedance of the grounding and maximizes the filter's performance. Please contact us if using a thinner land pad than 18μm for NFM55P.

Land Pattern + Solder Resist
 Land Pattern
 Solder Resist (in mm)

BLM03
BLM15
BLM18
BLM21
BLM31
BLM41

●Reflow and Flow

BLM Series (Except BLM□□P series)

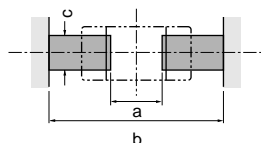

Type	Soldering	a	b	c
* BLM03	Reflow	0.2-0.3	0.6-0.9	0.3
* BLM15	Reflow	0.4	1.2-1.4	0.5
BLM18 (except 18PG type)	Flow	0.7	2.2-2.6	0.7
	Reflow		1.8-2.0	
BLM21 (except 21PG type)	Flow/ Reflow	1.2	3.0-4.0	1.0
BLM31 (except 31PG type)		2.0	4.2-5.2	1.2
BLM41 (except 41P□ type)		3.0	5.5-6.5	

*BLM03/15 is specially adapted for reflow soldering.

Flow Mounting in High Density for BLM31/41

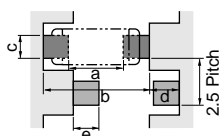

Type	a	b	c	d	e
BLM31	2.0	4.2-5.2	1.2	1.3	1.35
BLM41	3.0	5.5-6.5	1.2	1.8	1.5

●Do not apply narrower pattern that listed above to BLM□□P.
Narrow pattern can cause excessive heat or open circuit.

BLM□□P

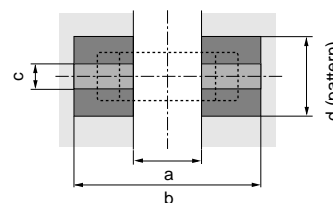

Type	Rated Current (A)	Soldering	a	b	c	Land pad thickness and dimension d		
						18μm	35μm	70μm
BLM18PG	0.5-1.5	Flow 2.2-2.6 Reflow 1.8-2.0	0.7	0.7	0.7	0.7	0.7	0.7
	2					1.2	0.7	0.7
	3					2.4	1.2	0.7
BLM21PG	1.5	Flow/ Reflow	1.2	3.0-4.0	1.0	1.0	1.0	1.0
	2					1.2	1.0	1.0
	3					2.4	1.2	1.0
	6					6.4	3.3	1.65
BLM31PG	1.5/2	Flow/ Reflow	2.0	4.2-5.2	1.2	1.2	1.2	1.2
	3					2.4	1.2	1.2
	6					6.4	3.3	1.65
BLM41P□	1-2	Flow/ Reflow	3.0	5.5-6.5	1.2	1.2	1.2	1.2
	3					2.4	1.2	1.2
	6					6.4	3.3	1.65

BLA2A
BLA31

●Reflow soldering

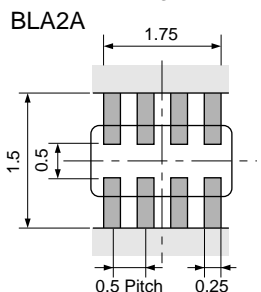

●Reflow and Flow

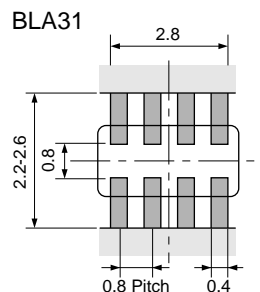

• If there are high amounts of self-heating on pattern, the contact points of PCB and part may become damaged.

Continued on the following page. ↗

EMIFIL® (Soldering and Mounting)

Continued from the preceding page.

Land Pattern + Solder Resist
 Land Pattern
 Solder Resist (in mm)

NFM18

Reflow Soldering
NFM18C/NFM18P/NFL18ST

The chip EMI filter suppress noise by passing the high-frequency noise to ground. Therefore, to get noise suppression effectively, it is recommended to put through holes (ø0.3 mm) into the center and both sides of ground-pattern to connect to ground-plane.

- NFM18, NFL21 are specially adapted for reflow soldering.

NFL18SP

NFM21, NFM3D, NFM41, NFR21G, NFL21S, VFM41R

● Reflow Soldering

Chip mounting side

Back side

Part Number	Size (mm)			
	a	b	c	d
NFM21C/NFM21P	0.8	1.4	2.6	0.6
NFR21G/NFL21S				
NFM3DC	1.4	2.5	4.4	1.0
NFM3DP				
NFM41C	2.0	3.5	6.0	1.2
NFM41P				
VFM41R	2.0	3.5	6.0	1.2

● Flow Soldering

Chip mounting side

Back side

Part Number	Size (mm)						
	a	b	c	d	e	f	g
NFM3DC	1.0	1.4	2.5	4.4	1.0	2.0	2.4
NFM3DP							
NFM41C	1.5	2.0	3.5	6.0	1.2	2.6	3.0
NFM41P							
VFM41R	1.5	2.0	3.5	6.0	1.2	2.6	3.0

NFA31G, NFA31C, NFW31S, NFE31P

● Reflow Soldering NFA31G/31C

R0.1 to R0.2 is preferred to obtain high voltage withstanding

● Reflow and Flow NFW31S
● Reflow Soldering NFE31P

Chip mounting side

Back side

Continued on the following page. ➤

EMIFIL® (Soldering and Mounting)

Continued from the preceding page.

Land Pattern
 + Solder Resist
 Land Pattern
 Solder Resist
 (in mm)

NFE61P NFE61H	<p>● Reflow Soldering</p> <p>Chip mounting side</p> <p>Back side</p> <p>Connect to ground pattern of mounting side</p>	<p>● Flow Soldering (Except NFE61H3321)</p> <p>Chip mounting side</p> <p>Back side</p> <p>Connect to ground pattern of mounting side</p>
DLM2HG DLP31S DLP31D DLP11S DLW21S DLW21H DLW31S DLW5AH DLW5BS	<p>● Reflow and Flow</p> <div style="display: flex; justify-content: space-around;"> <div style="text-align: center;"> <p>DLM2HG</p> </div> <div style="text-align: center;"> <p>DLP31S</p> </div> <div style="text-align: center;"> <p>DLP31D</p> </div> </div>	
	<p>● Reflow Soldering</p> <div style="display: flex; justify-content: space-around;"> <div style="text-align: center;"> <p>DLP11S</p> </div> <div style="text-align: center;"> <p>DLW21/DLW31S</p> </div> </div> <div style="margin-top: 20px;"> <p>DLW5AH/5BS</p> </div>	

Series	a	b	c	d
DLW21S/H	0.8	2.6	0.4	1.2
DLW31S	1.6	3.7	0.4	1.6

- * 1 : If the pattern is made with wider than 1.2mm (DLW21) / 1.6mm (DLW31S) it may result in components turning around, because melting speed is different. In the worst case, short circuit between lines may occur.
- * 2 : If the pattern is made with less than 0.4mm, in the worst case, short circuit between lines may occur due to spread of soldering paste or mount placing accuracy.
- * 3 : If the pattern is made with wider than 0.8mm (DLW21) / 1.6mm (DLW31S), the bending strength will be reduced. With gild pattern, excess soldering heat may dissolve metal of a copper wire.

Continued on the following page. ↗

EMIFIL® (Soldering and Mounting)

Continued from the preceding page.

2. Solder Paste Printing and Adhesive Application

When reflow soldering the chip EMI suppression filter, the printing must be conducted in accordance with the following cream solder printing conditions.

If too much solder is applied, the chip will be prone to damage by mechanical and thermal stress from the PCB and may crack. In contrast, if too little solder is applied, there is the potential that the termination strength will be insufficient, creating the potential for detachment.

Standard land dimensions should be used for resist and

copper foil patterns.

When flow soldering the EMI suppression filter, apply the adhesive in accordance with the following conditions.

If too much adhesive is applied, then it may overflow into the land or termination areas and yield poor solderability.

In contrast, if insufficient adhesive is applied, or if the adhesive is not sufficiently hardened, then the chip may become detached during flow soldering process.

(in mm)

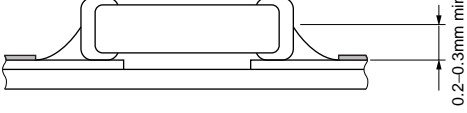
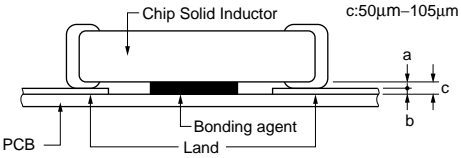
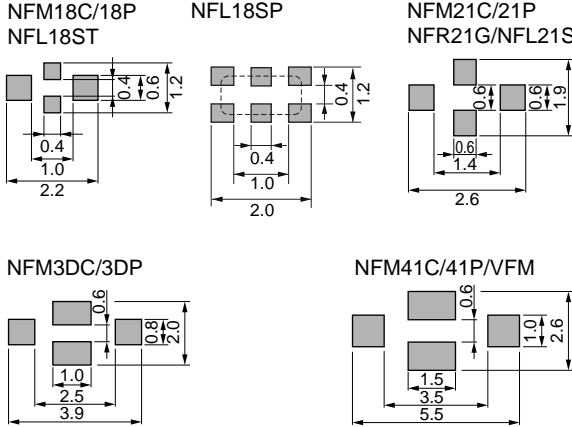
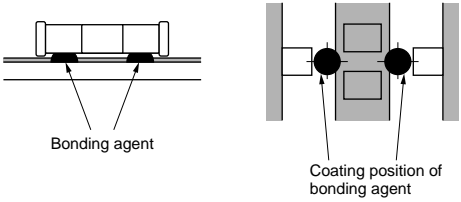
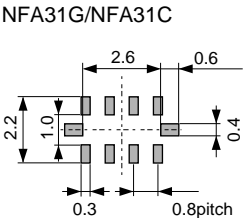
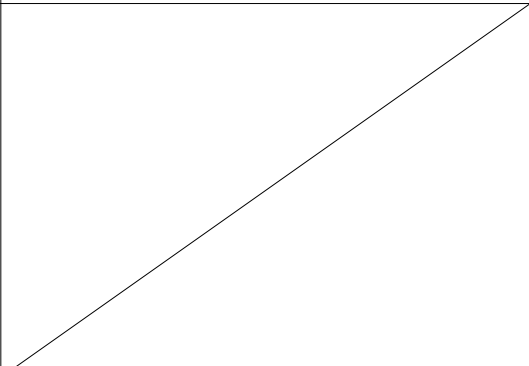
Series	Solder Paste Printing	Adhesive Application
BLM BLA	<ul style="list-style-type: none"> ● Ensure that solder is applied smoothly to a minimum height of 0.2mm to 0.3mm at the end surface of the part. ● Coat the solder paste a thickness: 100-150µm: BLM03 100-200µm: BLM15/18/21/31/41, BLA 	<p>Coating amount is illustrated in the following diagram.</p>  <p>a: 20µm-70µm b: 30µm-35µm c: 50µm-105µm</p>
NFM NFR NFL VFM	<ul style="list-style-type: none"> ● Use H60A solder for pattern printing. ● Coat the solder paste a thickness: 100-150µm: NFM18/21/3D, NFR, NFL 100-200µm: NFM41, VFM 	<p>Apply 0.1mg for NFM41C/41P/VFM and 0.06mg for NFM3DC/3DP of bonding agent at each chip. Do not cover electrodes.</p> 
NFA	<ul style="list-style-type: none"> ● Use H60A solder for pattern printing. ● Coat the solder paste a thickness: 100-200µm 	

Continued on the following page. ↗

EMIFIL® (Soldering and Mounting)

Continued from the preceding page.

(in mm)

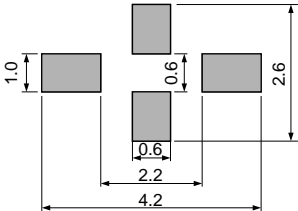
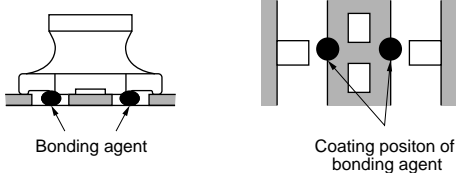
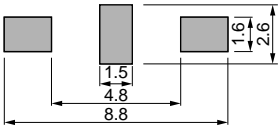
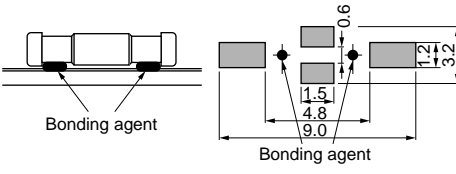
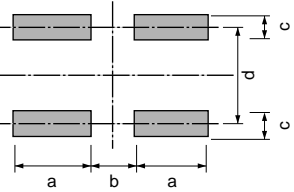
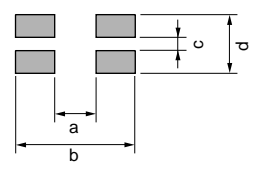
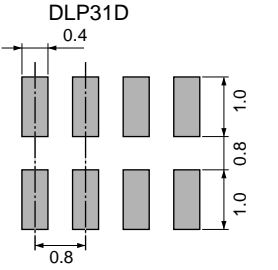
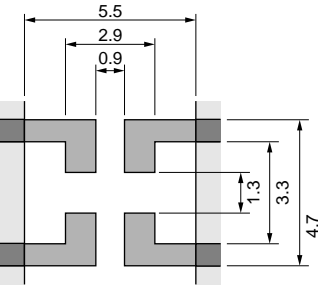
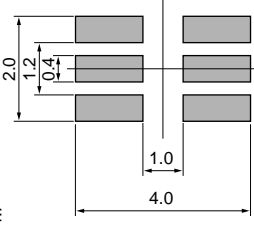
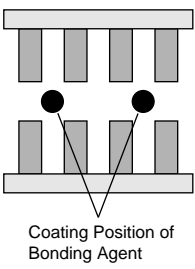
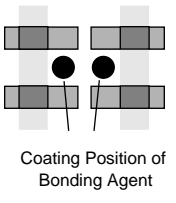
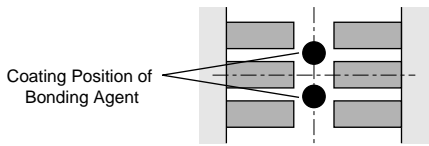
Series	Solder Paste Printing	Adhesive Application																														
NFW31S NFE31P	<ul style="list-style-type: none"> ●Use H60A solder for pattern printing. ●Coat the solder paste a thickness: 150-200µm 	<p>NFW31S Series Apply 0.2mg of bonding agent at each chip.</p> 																														
NFE61P NFE61H	<ul style="list-style-type: none"> ●Use H60A solder for pattern printing. ●Coat the solder paste a thickness: 150-200µm 	<p>Apply 1.0mg of bonding agent at each chip.</p> 																														
DLP DLW DLM	<ul style="list-style-type: none"> ●Use H60A solder for pattern printing. ●Coat the solder paste a thickness: 100-150µm: DLW21S/21H/31S/DLP11S 150-200µm: DLP31D/31S, DLM2HG, DLW5AH/5BS <div style="display: flex; justify-content: space-around;"> <div data-bbox="327 1108 622 1344"> <p>DLP11S/31S</p>  </div> <div data-bbox="646 1108 917 1321"> <p>DLW21S/DLW21H/DLW31S</p>  </div> </div> <table border="1" data-bbox="343 1355 622 1456"> <thead> <tr> <th>Series</th> <th>a</th> <th>b</th> <th>c</th> <th>d</th> </tr> </thead> <tbody> <tr> <td>DLP11S</td> <td>0.7</td> <td>0.55</td> <td>0.3</td> <td>0.55</td> </tr> <tr> <td>DLP31S</td> <td>1.0</td> <td>0.6</td> <td>0.7</td> <td>2.1</td> </tr> </tbody> </table> <table border="1" data-bbox="646 1355 917 1456"> <thead> <tr> <th>Series</th> <th>a</th> <th>b</th> <th>c</th> <th>d</th> </tr> </thead> <tbody> <tr> <td>DLW21S/H</td> <td>0.8</td> <td>2.6</td> <td>0.5</td> <td>1.2</td> </tr> <tr> <td>DLW31S</td> <td>1.6</td> <td>3.7</td> <td>0.4</td> <td>1.6</td> </tr> </tbody> </table> <div style="display: flex; justify-content: space-around; margin-top: 20px;"> <div data-bbox="343 1489 622 1758"> <p>DLP31D</p>  </div> <div data-bbox="343 1758 662 2094"> <p>DLW5AH/5BS</p>  </div> <div data-bbox="662 1758 917 2038"> <p>DLM2HG</p>  </div> </div>	Series	a	b	c	d	DLP11S	0.7	0.55	0.3	0.55	DLP31S	1.0	0.6	0.7	2.1	Series	a	b	c	d	DLW21S/H	0.8	2.6	0.5	1.2	DLW31S	1.6	3.7	0.4	1.6	<p>DLP31S/DLM2HG Apply 0.3mg of bonding agent at each chip.</p> <div style="display: flex; justify-content: space-around; margin-top: 20px;"> <div data-bbox="986 1131 1181 1444"> <p>DLP31D</p>  </div> <div data-bbox="1268 1131 1444 1400"> <p>DLP31S</p>  </div> </div> <div style="display: flex; justify-content: center; margin-top: 20px;"> <div data-bbox="1013 1444 1444 1612"> <p>DLM2HG</p>  </div> </div>
Series	a	b	c	d																												
DLP11S	0.7	0.55	0.3	0.55																												
DLP31S	1.0	0.6	0.7	2.1																												
Series	a	b	c	d																												
DLW21S/H	0.8	2.6	0.5	1.2																												
DLW31S	1.6	3.7	0.4	1.6																												

Continued on the following page. ↗

EMIFIL® (Soldering and Mounting)

☐ Continued from the preceding page.

3. Standard Soldering Conditions

(1) Soldering Methods

Use flow and reflow soldering methods only.

Use standard soldering conditions when soldering chip EMI suppression filters chip varistor.

In cases where several different parts are soldered, each having different soldering conditions, use those conditions requiring the least heat and minimum time.

(2) Soldering Temperature and Time

To prevent external electrode solder leaching and performance deterioration, solder within the temperature and time combinations illustrated by the slanted lines in the following graphs. If soldering is repeated, please note that the allowed time is the accumulated time.

Solder : H60A H63A solder(JIS Z 3238)

Flux :

- Use Rosin-based flux (when using RA type solder, clean products sufficiently to avoid residual flux.
- Do not use strong acidic flux (with chlorine content exceeding 0.20wt%)
- Do not use water-soluble flux.

● Allowable Flow Soldering Temperature and Time

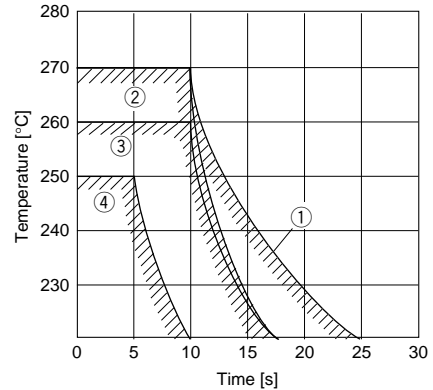

①	NFE61P/H(Except NFE61HT332)
②	BLM(Except BLM03/15), BLA31
③	DLM2HG, DLP31D/S
④	VFM41R, NFM3DC/P, NFM41C/P, NFW31S

● Allowable Reflow Soldering Temperature and Time

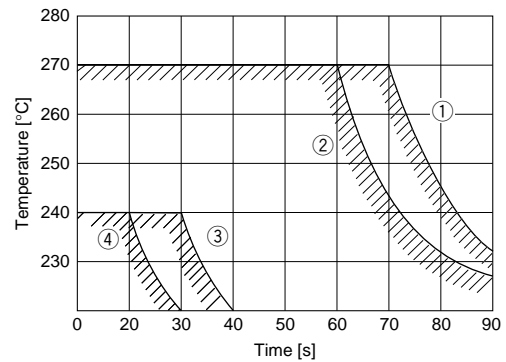

①	NFE31P/NFE61P/H
②	BLM/BLA
③	DLM2HG, DLP31D/S, DLP11S
④	NFM, NFL, NFA, NFR, HFW31S, DLW, VFM41R

Continued on the following page. ☐

EMIFIL[®] (Soldering and Mounting)

Continued from the preceding page.

(3) Soldering Conditions

(4) Reworking with Solder Iron

The following conditions must be strictly followed when using a soldering iron.

Pre-heating : 150°C 60 s min.

Soldering iron power output : 30W max.

Temperature of soldering iron tip / Soldering time : 280°C max./10s max. or 300°C max./3s max.*

*NFE31PT152Z1E9/VFM : 280°C max./10 s max. only

BLM : 350°C max./3 s max.

Do not allow the tip of the soldering iron to directly contact the chip.

For additional methods of reworking with to soldering iron, please contact Murata engineering.

4. Cleaning

Following conditions should be observed when cleaning chip EMI filter.

(1) Cleaning Temperature : 60°C max. (40°C max. for alcohol type cleaner)

(2) Ultrasonic

Output : 20W/liter max.

Duration : 5 minutes max.

Frequency : 28kHz to 40kHz

(3) Cleaning agent

The following list of cleaning agents have been tested on the individual components. Evaluation of final assembly should be completed prior to production.

Do not clean DLW21S/31S/5AH/5BS series.

In case of cleaning, please contact Murata engineering.

a) Alcohol cleaning agent

Isopropyl alcohol (IPA)

●Flow Solder

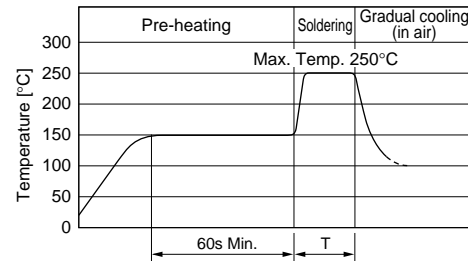

Series	Pre-heating (150°C)	Soldering Time(T)	Soldering Temp.(C)
BLM(Except BLM03/15), BLA31	60s min.	10s max.	250
NFM3DC/P, NFM41C/P, NFW31S, NFE61P/H*, DLM2HG, DLP31D/31S		5s max.	
VFM			

*Except NFE61HT332

●Reflow Solder

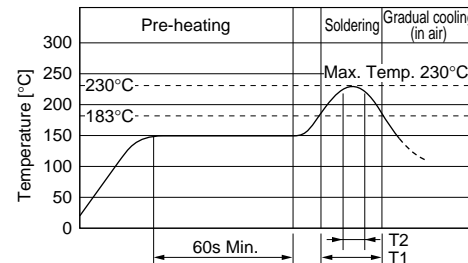

Series	Pre-heating (150°C)	Soldering Time	
		T1(183°C)	T2(230°C)
NFE31/61	60s min.	60s max.	250°C, 20s max.
BLM, BLA			20s max.
NFM, NFL, NFR			10s max.
NFW, NFA, DLM/P/W			
VFM			

b) Aqueous cleaning agent

Surface active agent (Clean Thru 750H)

Hydrocarbon (Cold Cleaner 375)

High grade alcohol (Pine Alpha ST-100S)

*VFM41R series cannot be cleaned with high grade alcohol type aqueous cleaning agent.

Alkaline saponifier (Aqua Cleaner 210SEI-cleaner should be diluted within 15% using deionized water.)

(4) Ensure that flux residue is completely removed.

Component should be thoroughly dried after aqueous agent has been removed with deionized water.

(5) Some products may become slightly whitened.

However, product performance or usage is not affected.

For additional cleaning methods, please contact Murata engineering.

Lead Type EMIFIL® (Soldering and Mounting)

1. Mounting Hole

Mounting holes should be designed as specified below.

Part number	Bulk type (in mm)	Taping type (in mm)
DSN6 DSS6 VFR3V VFS6V		
DSN9 DSN9H		
DST9 DST9H		
DSS9 DSS9H VFS9V		
BNX	<p>[Component Side]</p>	<p>[TERMINAL LAYOUT (Bottom figure)]</p>

2. Using THE block type EMIFIL® effectively

The block type EMIFIL® effectively prevents unwanted reflections and external noise from entering the equipment circuitry and power lines by grounding all the high frequency components which make up the noise. Therefore, if grounding is improperly done, the filters may be unable to achieve the performance they are capable of. To prevent this, be sure to observe the following instructions.

- (1) When designing the P.C. board, use all the available grounding terminals, and arrange the grounding circuit so that the area of the foil for the grounding circuit is maximized.
- (2) Minimize the distance between the P.C. board ground and the filter's grounding plate. Use through-hole P.C. boards.
- (3) Whichever P.C. board is used, push the filter into the P.C. board up to the terminal roots.
- (4) Do not connect PSG to CG by any other means except through the filter. (See the item 1. TERMINAL LAYOUT)

[P.C.B. BOARD PATTERNS]

Use a bilateral P.C. board. Insert the BNX into the P.C. board until the root of the terminal is secured. then solder.

(1) FRONT VIEW

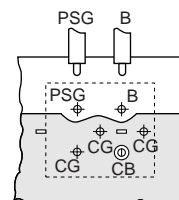

(2) BOTTOM VIEW

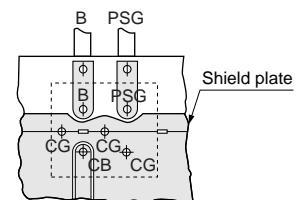

PSG : Power supply ground
CG : Load circuit ground
CB : Load circuit + Bias

Lead Type EMIFIL[®] (Soldering and Mounting)

☐ Continued from the preceding page.

3. Using EMIGUARD[®] effectively

- (1) Terminal (with mark) should be connected to the line of incoming electrostatic surge. (There is polarity.)
Otherwise, no effect in ESD suppression can be expected. (VFR3V)
- (2) Products should be used at rated voltage or less and rated current or less.
- (3) Products should not be applied for the absorption of surges which have large energy (ex. induced lightning surges, switching surges) because it is designed for the absorption of electrostatic surges. (VFR3V)
- (4) Electrostatic test should be done on the following conditions. (VFR3V)

$$n \cdot [C / R \cdot V^2]^2 < 8.0 \times 10^5$$
 - n : Times applies
 - C : Charging Capacitance (pF)
 - V : Testing Voltage (kV)
 - R : Charging Resistance (Ω)

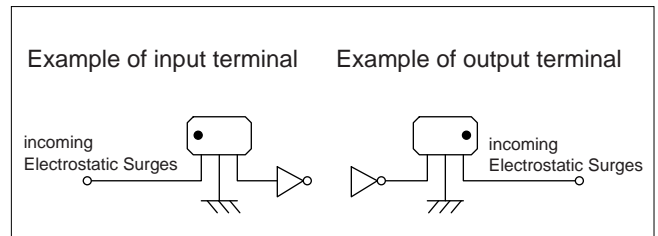

4. Soldering

- (1) Use Rosin-based flux. Do not use strong acidic flux with halide content exceeding 0.2 (wt)% (chlorine conversion value).
- (2) Standard flow soldering profile.
- (3) Products and the leads should not be subjected to any mechanical stress during the soldering process, or while subjected to the equivalent high temperatures.

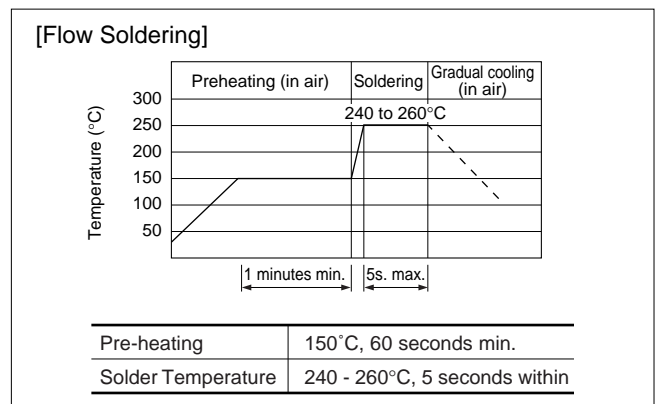

5. Cleaning Conditions

Do not clean VFR3V, PLT09H and VFS6Vseries.
Clean other parts in the following conditions.

- (1) Cleaning temperature should be limited to 60°C
max.(40°C max for alcohol type cleaner.)
- (2) Ultrasonic cleaning should be comply with the following conditions, avoiding the resonance phenomenon at the mounted products and P.C.B.
Power : 20 W / l max. Frequency : 28kHz to 40kHz
Time : 5 min. max.
- (3) Cleaner
 - a) Alcohol type cleaner
 - Isopropyl alcohol (IPA)
 - b) Aqueous agent (PLT series cannot be cleaned)
 - Surface Active Agent Type (CLEANTHROUGH 750H)

- Hydrocarbon Type (COLDCLEANER 375)
- Higher Alcohol Type (PINE ALPHA ST-100S)
- Alkali Saponification Type (*AQUACLEANER 210SEI)
- * Alkali saponification should be diluted to 15% volume with de-ionized water.

- (4) There should be no residual flux or residual cleaner after cleaning.
In the case of using aqueous agent, products should be dried completely after rinsing with de-ionized water in order to remove the cleaner.
- (5) Other cleaning : Please contact us.

Chip EMIFIL® Packaging

■ Minimum Quantity and Dimensions of 8mm Width Paper / Plastic Tape

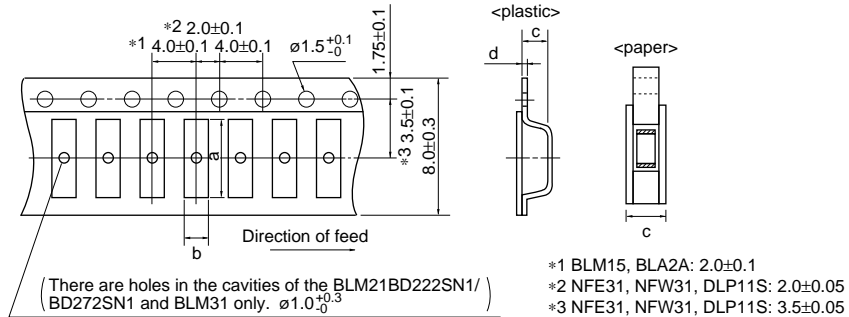

Part Number	Cavity Size				Minimum Qty. (pcs.)				Bulk
					ø180mm reel		ø330mm reel		
	a	b	c	d	Paper Tape	Plastic Tape	Paper Tape	Plastic Tape	
BLM03	0.70	0.40	0.55	-	15000	-	-	-	1000
BLM15	1.15	0.65	0.8	-	10000	-	50000	-	1000
BLM18 (BLM18E_TN1)	1.85	1.05	1.1 0.75	-	4000	-	10000	-	1000
BLM21 (BD222SN1/BD272SN1)	2.25	1.45	1.1 1.3	- 0.2	4000 -	- 3000	10000 -	- 10000	1000
BLM31 (AF700SN1)	3.5	1.9	1.3 1.75	0.2	- -	3000 2500	- -	10000 8000	1000
BLA2A	2.2	1.2	0.8	-	10000	-	-	-	1000
BLA31	3.4	1.8	1.1	-	4000	-	10000	-	1000
NFM18/NFL18S NFM18PC (Except 105R)	1.85	1.05	0.9	-	4000	-	-	-	500
NFL18ST/NFM18PC105R			1.1	-	4000	-	-	-	500
NFM21/NFL21S	2.3	1.55	1.1	-	4000	-	-	-	500
NFM3DC/3DP	3.4	1.4	0.85	0.2	-	4000	-	-	500
NFA31G/31C	3.5	2.0	1.1	-	4000	-	-	-	100
NFE31P	3.6	1.9	2.0	0.2	-	2000	-	8000	500
NFR21G	2.3	1.55	0.7	0.25	-	4000	-	-	500
NFW31S	3.6	1.9	2.0	0.2	-	2000	-	7500	-
DLM2HG	2.75	2.25	1.3	0.25	-	3000	-	-	1000
DLP11S	1.4	1.2	0.98	0.25	-	3000	-	-	500
DLP31D/31S	3.5	1.9	1.3	0.25	-	3000	-	-	500
DLW21S	2.25	1.45	1.4	0.3	-	2000	-	-	500
DLW21H	2.3	1.55	1.1	0.25	-	3000	-	-	500
DLW31S	3.6	2.0	2.1	0.3	-	2000	-	-	500

• Please contact us for BLM15/18 in bulk case.

(in mm)

Continued on the following page.

Chip EMIFIL[®] Packaging

Continued from the preceding page.

Minimum Quantity and Dimensions of 12mm Width Plastic Tape

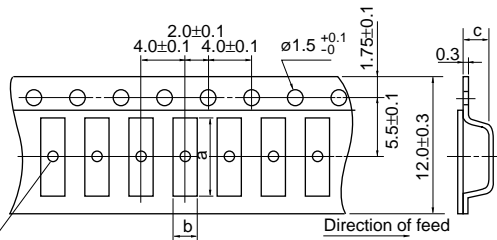

(There are holes in the cavities of the BLM41 only. $\phi 1.5^{+0.3}_{-0}$)

Part Number	Cavity Size			Minimum Qty. (pcs.)		
	a	b	c	ø180mm reel	ø330mm reel	Bulk
BLM41	4.8	1.9	1.75	2500	8000	1000
NFM41	4.8	1.8	1.1	4000	-	500
NFE61	7.2	1.9	1.75	2500	8000	500
VFM41R	4.8	1.8	1.35	2500	-	500

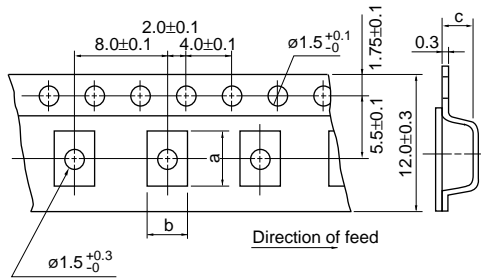

Part Number	Cavity Size			Minimum Qty. (pcs.)		
	a	b	c	ø180mm reel	ø330mm reel	Bulk
DLW5AH	5.4	4.1	4.4	400	1500	100
DLW5BS	5.5	5.4	4.7	400	1500	100

(in mm)

Ferrite Beads Inductors Packaging

■ Minimum Quantity (Pcs.)

Series	Bulk	Ammo Pack	ø320mm Paper reel
BL01RN	500	1000	2000
BL02RN	500	1500	—
BL03RN	1000	2000	—

■ Taping Dimensions

BL01RN

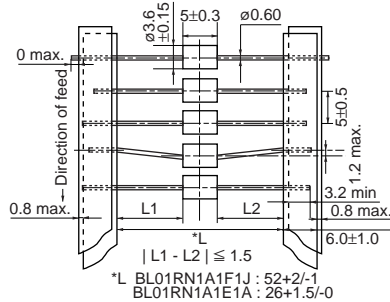

BL02RN1R2□1A

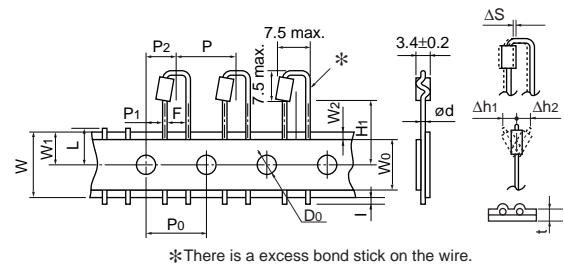

BL02RN1R3N1A

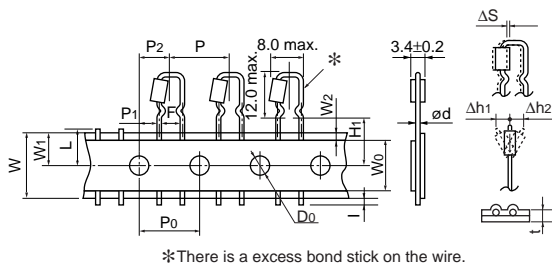

BL02RN2R1□1A

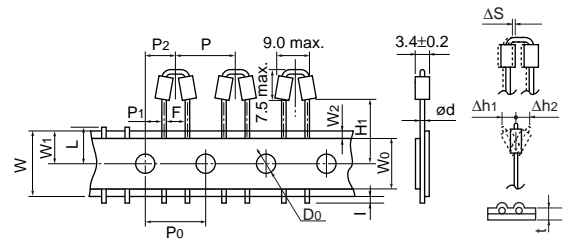

BL02RN2R3N1A

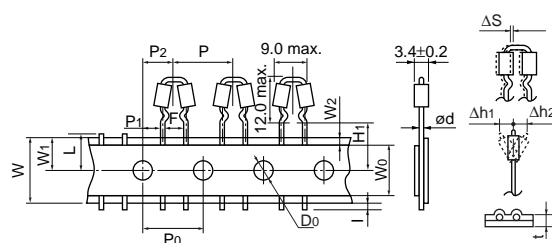

BL03RN2R1□1A

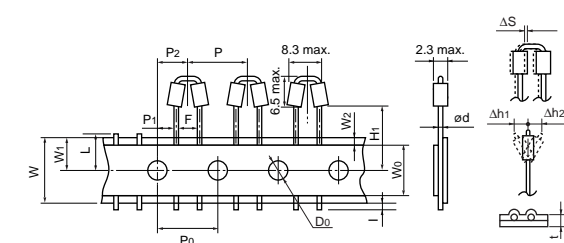

Description	Symbol	Dimension (mm)	Remarks
Pitch of component	P	12.7	Product inclination ΔS determines tolerance
Pitch of sprocket hole	P0	12.7±0.2	
Lead spacing	F	5.0 ^{+0.8} _{-0.2}	
Hole center to lead	P1	3.85±0.7	
Hole center to component center	P2	6.35±1.3	Tape deviation in feeding direction
Deviation along tape, left or right	ΔS	±1.0	
Carrier tape width	W	18.0±0.5	
Position of sprocket hole	W1	9.0 ⁺⁰ _{-0.5}	Tape with deviation
Lead length between sprocket hole and forming position	H1	Lead Length Number : N	16.5±0.5
		Lead Length Number : Q	20.0±0.5
		Lead Length Number : P	18.5±0.5
Protruding length	l	+0.5 to -1.0	
Diameter of sprocket hole	D0	ø4.0±0.1	
Lead Diameter	ød	ø0.60	
Total tape thickness	t	0.7±0.2	Including bonding tape thickness
Deviation across tape, Deviation across tape rear	Δh1, Δh2	1.0 max.	
Cutting position of failure	L	11.0 ⁺⁰ _{-1.0}	
Hold down tape width	W0	12.0±0.5	
Hold down tape position	W2	1.5±1.5	

(in mm)

Disc Type EMIFIL[®] and EMIGUARD[®] Packaging

Minimum Quantity

Part Number	Minimum Order Quantity (order in sets only) (Pcs.)		
	Ammo Pack	ø320mm Paper reel	Bulk (Bag)
VFR3V Series	2000	—	250
DS□6/VFS6V Series	2000	—	250
DSN9/9H Series	2000	—	250
DST9/9H Series	1000 ^{*1}	1000 ^{*2}	200
DSS9/9H Series	—	800	200
VFS9V Series	—	800	200

*1 : Q92, Q93 *2 : Q91

Lead Type Code

Lead Type code		Lead length (H)
Straight Type	Incrimp Type	
Q91	-	20.0±1.0mm
Q92	U21	16.5±1.0mm
Q93	U31	18.5±1.0mm

Taping Dimensions

DSN6_Q91/Q92/Q93

DSN9_Q91/Q92/Q93

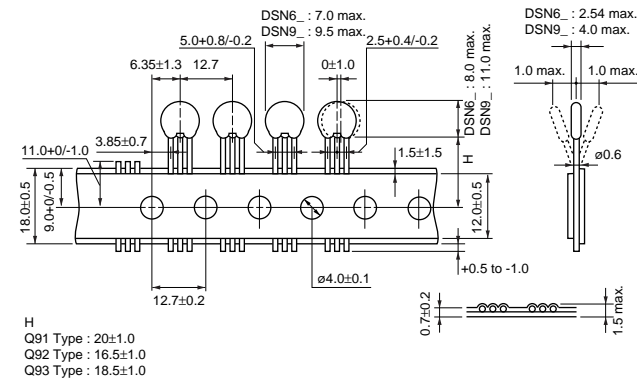

DSS6_Q91/Q92/Q93

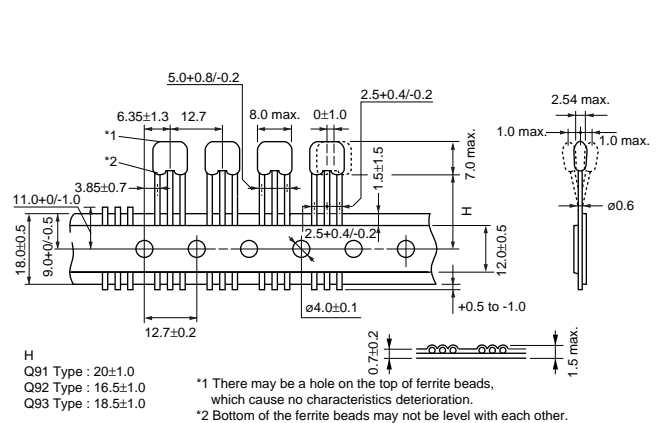

DST9_Q91/Q92/Q93

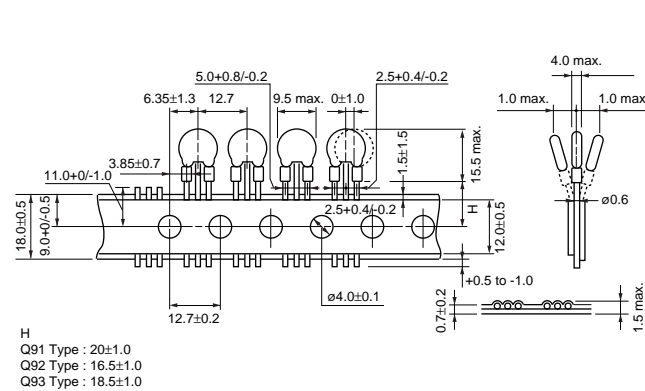

DSS6_U21/U31

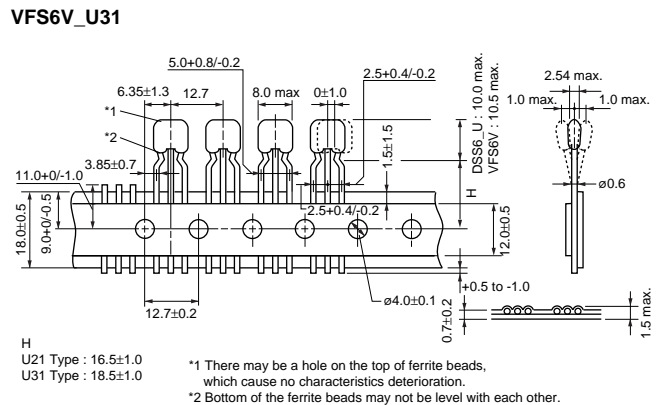

DSS9_Q91/Q92/Q93

VFS9V_Q91/Q92/Q93

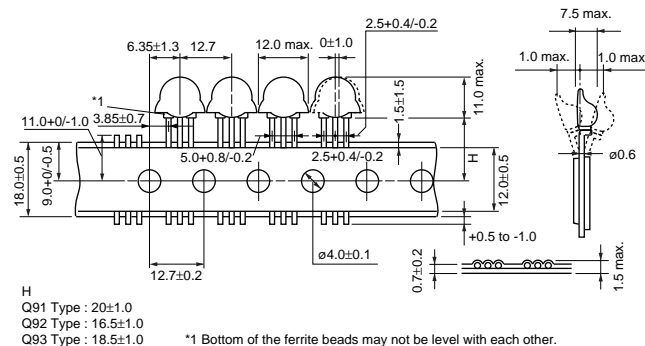

VFR3V_U31

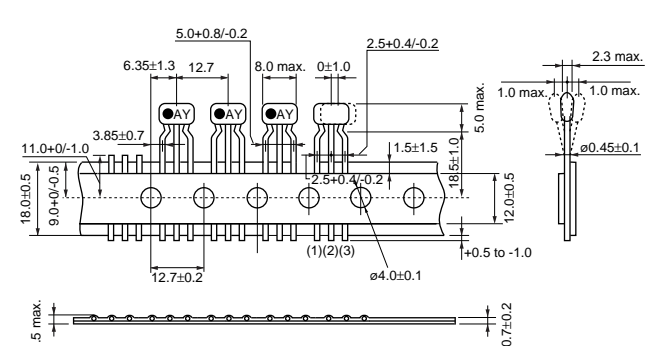

(in mm)

Chip EMI Suppression Filter Design Kits



●EKEMBL15C (Chip Ferrite Beads 0402 Size)

No.	Part Number	Quantity (pcs.)	Impedance typ. (at 100MHz, 20 degree C)	Rated Current (mA)	DC Resistance (Ω) max.
1	BLM15AG100SN1	20	10Ω (Typ.)	1000	0.05
2	BLM15AG700SN1	20	70Ω (Typ.)	500	0.15
3	BLM15AG121SN1	20	120Ω±25%	500	0.25
4	BLM15AG221SN1	20	220Ω±25%	300	0.35
5	BLM15AG601SN1	20	600Ω±25%	300	0.60
6	BLM15AG102SN1	20	1000Ω±25%	200	1.00
7	BLM15BB050SN1	20	5Ω±25%	500	0.08
8	BLM15BB100SN1	20	10Ω±25%	300	0.10
9	BLM15BB220SN1	20	22Ω±25%	300	0.20
10	BLM15BB470SN1	20	47Ω±25%	300	0.35
11	BLM15BB750SN1	20	75Ω±25%	300	0.40
12	BLM15BB121SN1	20	120Ω±25%	300	0.55
13	BLM15BB221SN1	20	220Ω±25%	200	0.80
14	BLM15BD471SN1	20	470Ω±25%	200	0.60
15	BLM15BD601SN1	20	600Ω±25%	200	0.65
16	BLM15BD102SN1	20	1000Ω±25%	200	0.90

●EKEMBL18A (Chip Ferrite Beads 0603 Size/ for Large-current P Type)

No.	Part Number	Quantity (pcs.)	Impedance typ. (at 100MHz, 20 degree C)	Rated Current (mA)	DC Resistance (Ω) max.
1	BLM18AG121SN1	20	120Ω±25%	200	0.20
2	BLM18AG221SN1	20	220Ω±25%	200	0.30
3	BLM18AG471SN1	20	470Ω±25%	200	0.50
4	BLM18AG601SN1	20	600Ω±25%	200	0.50
5	BLM18AG102SN1	20	1000Ω±25%	100	0.70
6	BLM18BA050SN1	20	5Ω±25%	500	0.20
7	BLM18BA100SN1	20	10Ω±25%	500	0.25
8	BLM18BA220SN1	20	22Ω±25%	500	0.35
9	BLM18BA470SN1	20	47Ω±25%	300	0.55
10	BLM18BA750SN1	20	75Ω±25%	300	0.35
11	BLM18BA121SN1	20	120Ω±25%	200	0.90
12	BLM18BB100SN1	20	10Ω±25%	500	0.15
13	BLM18BB220SN1	20	22Ω±25%	500	0.25
14	BLM18BB470SN1	20	47Ω±25%	500	0.30
15	BLM18BB600SN1	20	60Ω±25%	200	0.35
16	BLM18BB121SN1	20	120Ω±25%	200	0.50
17	BLM18BB221SN1	20	220Ω±25%	200	0.65
18	BLM18BB471SN1	20	470Ω±25%	50	1.00
19	BLM18BD121SN1	20	120Ω±25%	200	0.40

Continued on the following page.

Chip EMI Suppression Filter Design Kits

Continued from the preceding page.

No.	Part Number	Quantity (pcs.)	Impedance typ. (at 100MHz, 20 degree C)	Rated Current (mA)	DC Resistance (Ω) max.
20	BLM18BD221SN1	20	220Ω±25%	200	0.45
21	BLM18BD471SN1	20	470Ω±25%	200	0.55
22	BLM18BD601SN1	20	600Ω±25%	200	0.65
23	BLM18BD102SN1	20	1000Ω±25%	100	0.85
24	BLM18BD182SN1	20	1800Ω±25%	50	1.50
25	BLM18BD252SN1	20	2500Ω±25%	50	1.50
26	BLM18HG471SN1	20	470Ω±25%	200	0.85
27	BLM18HG601SN1	20	600Ω±25%	200	1.00
28	BLM18HG102SN1	20	1000Ω±25%	100	1.60
29	BLM18HD471SN1	20	470Ω±25%	100	1.20
30	BLM18HD601SN1	20	600Ω±25%	100	1.50
31	BLM18HD102SN1	20	1000Ω±25%	50	1.80
32	BLM18PG330SN1	20	33Ω±25%	3000	0.025
33	BLM18PG121SN1	20	120Ω±25%	2000	0.05
34	BLM18PG181SN1	20	180Ω±25%	1500	0.09
35	BLM21PG221SN1	20	220Ω (Typ.)	2000	0.05
36	BLM21PG331SN1	20	330Ω (Typ.)	1500	0.09
37	BLM31PG121SN1	20	120Ω (Typ.)	3000	0.025
38	BLM31PG391SN1	20	390Ω (Typ.)	2000	0.05
39	BLM31PG601SN1	20	600Ω (Typ.)	1500	0.9
40	BLM41PG181SN1	20	180Ω (Typ.)	3000	0.025
41	BLM41PG471SN1	20	470Ω (Typ.)	2000	0.05
42	BLM41PG102SN1	20	1000Ω (Typ.)	1500	0.09
43	BLM18RK121SN1	20	120Ω±25%	200	0.25
44	BLM18RK221SN1	20	220Ω±25%	200	0.3
45	BLM18RK471SN1	20	470Ω±25%	200	0.5
46	BLM18RK601SN1	20	600Ω±25%	200	0.6
47	BLM18RK102SN1	20	1000Ω±25%	200	0.8
48	BLM18HK471SN1	20	470Ω±25%	200	0.7
49	BLM18HK601SN1	20	600Ω±25%	100	0.9
50	BLM18HK102SN1	20	1000Ω±25%	50	1.5

●EKEMBL21A (Chip Ferrite Beads 0805 Size)

No.	Part Number	Quantity (pcs.)	Impedance typ. (at 100MHz, 20 degree C)	Rated Current (mA)	DC Resistance (Ω) max.
1	BLM21AG121SN1	20	120Ω±25%	200	0.15
2	BLM21AG221SN1	20	220Ω±25%	200	0.20
3	BLM21AG471SN1	20	470Ω±25%	200	0.25
4	BLM21AG601SN1	20	600Ω±25%	200	0.30
5	BLM21AJ601SN1	20	600Ω±25%	200	1.10
6	BLM21AG102SN1	20	1000Ω±25%	200	0.45
7	BLM21AH102SN1	20	1000Ω±25%	200	0.45
8	BLM21BB600SN1	20	60Ω±25%	200	0.20
9	BLM21BB750SN1	20	75Ω±25%	200	0.25
10	BLM21BB121SN1	20	120Ω±25%	200	0.25
11	BLM21BB221SN1	20	220Ω±25%	200	0.35
12	BLM21BB471SN1	20	470Ω±25%	200	0.45
13	BLM21BD121SN1	20	120Ω±25%	200	0.25
14	BLM21BD221SN1	20	220Ω±25%	200	0.25
15	BLM21BD471SN1	20	470Ω±25%	200	0.35
16	BLM21BD601SN1	20	600Ω±25%	200	0.35
17	BLM21BD102SN1	20	1000Ω±25%	200	0.40

Continued on the following page. ↗

Chip EMI Suppression Filter Design Kits

☐ Continued from the preceding page.

No.	Part Number	Quantity (pcs.)	Impedance typ. (at 100MHz, 20 degree C)	Rated Current (mA)	DC Resistance (Ω) max.
18	BLM21BD182SN1	20	1800Ω±25%	200	0.50
19	BLM21BD222SN1	20	2250Ω (Typ.)	200	0.60
20	BLM21BD222TN1	20	2200Ω±25%	200	0.60
21	BLM21BD272SN1	20	2700Ω±25%	200	0.80

●EKEMFL18B (Chip EMIFIL LC Combined Type)

No.	Part Number	Quantity (pcs.)	Cut off Frequency	Rated Voltage	Rated Current	Insulation Resistance (MΩ min.)	DC Resistance max.
1	NFL18ST107X1C3	20	100MHz	16 V	100mA	1000	4.5Ω
2	NFL18ST157X1C3	20	150MHz	16 V	100mA	1000	4.0Ω
3	NFL18ST207X1C3	20	200MHz	16 V	150mA	1000	3.5Ω
4	NFL18ST307X1C3	20	300MHz	16 V	200mA	1000	1.8Ω
5	NFL18ST507X1C3	20	500MHz	16 V	200mA	1000	1.5Ω
6	NFL18SP157X1A3	20	150MHz	10 V	100mA	1000	3.0Ω
7	NFL18SP207X1A3	20	200MHz	10 V	100mA	1000	3.0Ω
8	NFL18SP307X1A3	20	300MHz	10 V	100mA	1000	3.0Ω
9	NFL18SP507X1A3	20	500MHz	10 V	100mA	1000	2.0Ω
10	NFL21SP206X1C3	20	20MHz	16 V	100mA	1000	8.5Ω
11	NFL21SP506X1C3	20	50MHz	16 V	150mA	1000	3.5Ω
12	NFL21SP706X1C3	20	70MHz	16 V	150mA	1000	3.0Ω
13	NFL21SP107X1C3	20	100MHz	16 V	200mA	1000	2.0Ω
14	NFL21SP157X1C3	20	150MHz	16 V	200mA	1000	2.0Ω
15	NFL21SP207X1C3	20	200MHz	16 V	250mA	1000	1.5Ω
16	NFL21SP307X1C3	20	300MHz	16 V	300mA	1000	1.2Ω
17	NFL21SP407X1C3	20	400MHz	16 V	300mA	1000	1.2Ω
18	NFL21SP507X1C3	20	500MHz	16 V	300mA	1000	1.2Ω

No.	Part Number	Quantity (pcs.)	Cut off Frequency	Attenuation (dB min.)										Rated Current	Rated Voltage
				10MHz	20MHz	50MHz	100MHz	150MHz	200MHz	300MHz	400MHz	500MHz	1GHz		
19	NFW31SP106X1E4	20	10MHz	6dB max	5	25	25	-	25	-	-	30	30	200mA	25V
20	NFW31SP206X1E4	20	20MHz	-	6dB max	5	25	-	25	-	-	30	30	200mA	25V
21	NFW31SP506X1E4	20	50MHz	-	-	6dB max	10	-	30	-	-	30	30	200mA	25V
22	NFW31SP107X1E4	20	100MHz	-	-	-	6dB max	-	5	-	-	20	30	200mA	25V
23	NFW31SP157X1E4	20	150MHz	-	-	-	-	6dB max	-	10	20	30	30	200mA	25V
24	NFW31SP207X1E4	20	200MHz	-	-	-	-	-	6dB max	-	-	10	30	200mA	25V
25	NFW31SP307X1E4	20	300MHz	-	-	-	-	-	-	6dB max	-	5	15	200mA	25V
26	NFW31SP407X1E4	20	400MHz	-	-	-	-	-	-	-	6dB max	-	10	200mA	25V
27	NFW31SP507X1E4	20	500MHz	-	-	-	-	-	-	-	-	6dB max	10	200mA	25V

●EKEMFA31B (Chip EMIFIL Capacitor Array Type/ Capacitor Type/ LC Combined Type)

No.	Part Number	Quantity (pcs.)	Capacitance	Rated Voltage	Rated Current	Insulation Resistance (MΩ min.)
1	NFA31CC220S1E4	20	22pF±20%	25 V	200mA	1000
2	NFA31CC470S1E4	20	47pF±20%	25 V	200mA	1000
3	NFA31CC101S1E4	20	100pF±20%	25 V	200mA	1000
4	NFA31CC221S1E4	20	220pF±20%	25 V	200mA	1000
5	NFA31CC471R1E4	20	470pF±20%	25 V	200mA	1000
6	NFA31CC102R1E4	20	1000pF±20%	25 V	200mA	1000
7	NFA31CC222R1E4	20	2200pF±20%	25 V	200mA	1000
8	NFA31CC223R1C4	20	22000pF±20%	16 V	200mA	1000
9	NFA31GD1006R84	20	10pF±20%	6 V	50mA	1000
10	NFA31GD1004704	20	10pF±20%	6 V	20mA	500

Continued on the following page. ☐

Chip EMI Suppression Filter Design Kits

☐ Continued from the preceding page.

●EKEMFA31B (Chip EMIFIL Capacitor Array Type/ Capacitor Type/ LC Combined Type)

No.	Part Number	Quantity (pcs.)	Capacitance	Rated Voltage	Rated Current	Insulation Resistance (MΩ min.)
11	NFA31GD1001014	20	10pF±20%	6 V	15mA	1000
12	NFA31GD4706R84	20	47pF±20%	6 V	50mA	1000
13	NFA31GD4704704	20	47pF±20%	6 V	20mA	1000
14	NFA31GD4701014	20	47pF±20%	6 V	15mA	1000
15	MFA31GD1016R84	20	100pF±20%	6 V	50mA	1000
16	NFA31GD1014704	20	100pF±20%	6 V	20mA	1000
17	NFA31GD1011014	20	100pF±20%	6 V	15mA	1000

●EKEMDL21C (Chip Common Mode Choke Coils)

No.	Part Number	Quantity (pcs.)	Common Mode Impedance typ. (at 100MHz, 20 degree C)	Rated Voltage	Rated Current	Insulation Resistance (MΩ min.)
1	DLW21SN670SQ2	10	67Ω (Typ.)	50V	400mA	10
2	DLW21SN900SQ2	10	90Ω (Typ.)	50V	330mA	10
3	DLW21SN121SQ2	10	120Ω (Typ.)	50V	370mA	10
4	DLW21SN181SQ2	10	180Ω (Typ.)	50V	330mA	10
5	DLW21SN261SQ2	10	260Ω (Typ.)	50V	300mA	10
6	DLW21SN371SQ2	10	370Ω (Typ.)	50V	280mA	10
7	DLW31SN900SQ2	10	90Ω (Typ.)	50V	370mA	10
8	DLW31SN161SQ2	10	160Ω (Typ.)	50V	340mA	10
9	DLW31SN261SQ2	10	260Ω (Typ.)	50V	310mA	10
10	DLW31SN601SQ2	10	600Ω (Typ.)	50V	260mA	10
11	DLW31SN102SQ2	10	1000Ω (Typ.)	50V	230mA	10
12	DLW31SN222SQ2	10	2200Ω (Typ.)	50V	200mA	10
13	DLW5AHN402SQ2	5	4000Ω (Typ.)	50V	200mA	10
14	DLW5BSN302SQ2	5	3000Ω (Typ.)	50V	500mA	10
15	DLW5BSN152SQ2	5	1500Ω (Typ.)	50V	1000mA	10
16	DLW5BSN102SQ2	5	1000Ω (Typ.)	50V	1500mA	10
17	DLW5BSN351SQ2	5	350Ω (Typ.)	50V	2000mA	10
18	DLW5BSN191SQ2	5	190Ω (Typ.)	50V	5000mA	10
19	DLP31DN900ML4	10	90Ω±20%	10V	160mA	100
20	DLP31DN131ML4	10	130Ω±20%	10V	120mA	100
21	DLP31DN201ML4	10	200Ω±20%	10V	100mA	100
22	DLP31DN321ML4	10	320Ω±20%	10V	80mA	100
23	DLP31DN441ML4	10	440Ω±20%	10V	70mA	100

●EKEMNFMPA

No.	Part Number	Quantity (pcs.)	Capacitance	Rated Voltage	Rated Current	Insulation Resistance (MΩ min.)
1	NFM18PC104R1C3	20	0.1μF±20%	16 V	2A	1000
2	NFM18PC105R0J3	20	1μF±20%	6.3 V	2A	500
3	NFM21PC104R1E3	20	0.1μF±20%	25 V	2A	1000
4	NFM21PC224R1C3	20	0.22μF±20%	16 V	2A	1000
5	NFM21PC474R1C3	20	0.47μF±20%	16 V	2A	1000
6	NFM21PC105B1A3	20	1μF±20%	10 V	4A	500
7	NFM21PC105F1C3	20	1μF +80/-20%	16 V	2A	500
8	NFE31PT152Z1E9	20	1500pF +50/-20%	25 V	6A	1000
9	NFE31PT222Z1E9	20	2200pF±50%	25 V	6A	1000
10	NFE61PT102E1H9	20	1000pF +80/-20%	50 V	2A	1000
11	NFE61PT472C1H9	20	4700pF +80/-20%	50 V	2A	1000
12	NFM41PC204F1H3	20	0.2μF +80/-20%	50 V	2A	1000

Continued on the following page. ☐

Chip EMI Suppression Filter Design Kits

☐ Continued from the preceding page.

●EKEMNFMCA

No.	Part Number	Quantity (pcs.)	Capacitance	Rated Voltage	Rated Current	Insulation Resistance (MΩ min.)
1	NFM18CC220U1C3	20	22pF±20%	16 V	300mA	1000
2	NFM18CC470U1C3	20	47pF±20%	16 V	300mA	1000
3	NFM18CC101R1C3	20	100pF±20%	16 V	300mA	1000
4	NFM18CC221R1C3	20	220pF±20%	16 V	300mA	1000
5	NFM18CC471R1C3	20	470pF±20%	16 V	300mA	1000
6	NFM18CC102R1C3	20	1000pF±20%	16 V	300mA	1000
7	NFM18CC222R1C3	20	2200pF±20%	16 V	300mA	1000
8	NFM18CC223R1C3	20	22000pF±20%	16 V	1000mA	1000
9	NFM21CC220U1H3	20	22pF±20%	50 V	300mA	1000
10	NFM21CC470U1H3	20	47pF±20%	50 V	300mA	1000
11	NFM21CC101U1H3	20	100pF±20%	50 V	300mA	1000
12	NFM21CC221R1H3	20	220pF±20%	50 V	300mA	1000
13	NFM21CC471R1H3	20	470pF±20%	50 V	300mA	1000
14	NFM21CC102R1H3	20	1000pF±20%	50 V	300mA	1000
15	NFM21CC222R1H3	20	2200pF±20%	50 V	300mA	1000
16	NFM21CC223R1H3	20	22000pF±20%	50 V	2000mA	1000

Outlines of Major Noise Regulation Standards

1. EMI Regulations

Equipment		Countries	Information Regulation	Japan	USA	Europe
Emission	Generic Standard		CISPR61000-6-3 (Residential, Commercial and Light Industry) IEC61000-6-4 (Industrial)			EN50081-1 (Residential, Commercial and Light Industry) EN50081-2 (Industrial)
	ITE : Information Technology Equipment Printer, Personal computer Word processor, Display		CISPR 22	VCCI *1	FCC Part 15 Subpart B	EN55022
	ISM equipment, Microwave		CISPR 11	*1	FCC Part 18	EN55011
	Igniter (Automobile, Motorboat)		CISPR 12	JASO	FCC Part 15 Subpart B	Automotive Directive
	TV, Radio, Audio, VTR		CISPR 13	*1	FCC Part 15 Subpart B	EN55013
	Household electrical equipment Portable tool		CISPR 14	*1		EN55014
	Fluorescent Lamp, Luminary		CISPR 15	*1		EN55015
	Transceiver		ITU-T	Radio Act ARIB (Voluntary Regulation)	FCC Part 15 Subpart C FCC Part 22	ETS300 Series
	(Reference) Power Supply Higher Harmonic		IEC61000-3	Industrial Voluntary Regulation		EN61000-3
Immunity	Basic Standard		IEC61000-4	In the process of Regulating at JIS		EN61000-4 Series
	Generic Standard		IEC61000-6-1 (Residential, Commercial and Light Industry) IEC61000-6-2 (Industrial)	In the process of Regulating at JIS		EN50082-1 (Residential, Commercial and Light Industry) EN50082-2 (Industrial)
	Industrial Process Measurement and Control Equipment			Industrial Voluntary Action		
	Radio, TV		CISPR 20			EN55020
	ITE : Information Technology Equipment		CISPR 24			EN55024

*1 Electrical Appliance and Material Safety Law

There are EMI regulations in each country to meet EMI noise levels emitted from digital equipment. In the countries which regulate EMI, equipment which does not satisfy with regulations is not allowed to be sold.

Continued on the following page. 

Outlines of Major Noise Regulation Standards

☐ Continued from the preceding page.

2. Measurement Point and Noise Detection

Regulation	Measuring Item	Polarization and Measuring Point	Frequency (Hz)	Detection	Measuring Devices
CISPR 22/ EN55022	Radiated Interference	Horizontal Pol. Vertical Pol.	30M to 1GHz	Quasi-Peak Detection	Antenna
	Main Interference Voltage	AC Main Ports	150k to 30MHz	Quasi-Peak Detection Mean Detection	Artificial Main Network
VCCI	Radiated Interference	Horizontal Pol. Vertical Pol.	30M to 1GHz	Quasi-Peak Detection	Dipole Antenna
	Main Interference Voltage	AC Main Ports	150k to 30MHz	Quasi-Peak Detection Mean Detection	Artificial Main Network
FCC Part 15	Radiated Interference	Horizontal Pol. Vertical Pol.	30M to 40GHz	Quasi-Peak Detection Mean Detection	Antenna
	Main Interference Voltage	AC Main Ports	150k to 30MHz	Quasi-Peak Detection	Artificial Main Network

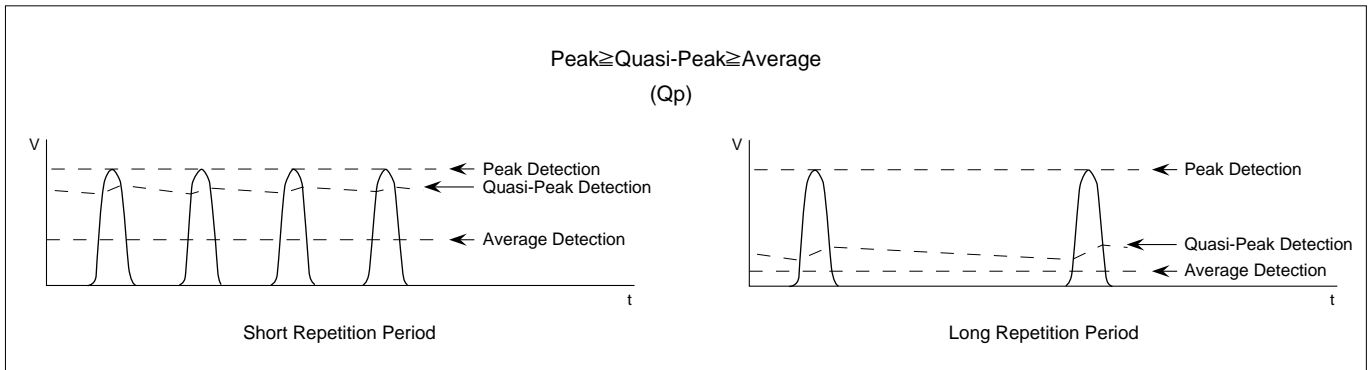

3. Limits of CISPR 22/EN55022

(1) CISPR 22 recommends measurement at 10m distance.
However, other distance is acceptable if the limitation is converted according to the following calculation.
Limitation shown left is converted to limitation for 3m

Conversion

Limitation for 10m Distance	→	Limitation for 3m Distance
R ₁₀ (dB μ V/m)		R ₃ (dB μ V/m)
r ₁₀ (μ V/m)		r ₃ (μ V/m)
R ₁₀ = 20 log r ₁₀		R ₃ = 20 log r ₃
		$R_3 = R_{10} + 20 (1 - \log 3)$
		$r_3 = \frac{10}{3} r_{10}$

[Main Terminal Interference Voltage (Power Supply)]

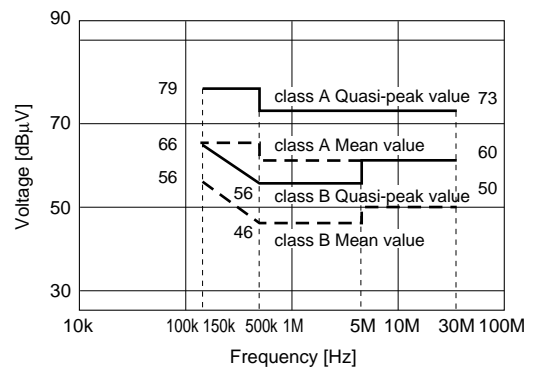

[Radiated Interference]

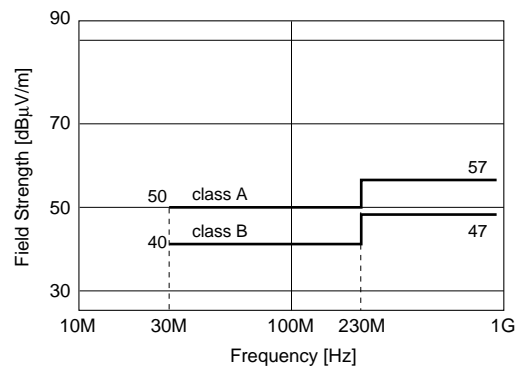

On the border frequency, lower limit should be applied.

Class A Equipment : The equipment which is used in light industrial commercial areas.

Class B Equipment : The equipment which is used in residential areas.

Continued on the following page. ☐

Outlines of Major Noise Regulation Standards

☐ Continued from the preceding page.

(2) Scope of CISPR 22 Regulation

This regulation applies to information technology equipment (ITE) which are defined as:

- (a) Equipment that receives data from external signal sources;
- (b) Equipment that processes received data;
- (c) Equipment that outputs data
- (d) Equipment that has less than 600V rated voltage in power supply

[CISPR Regulations]

- CISPR 10 Organization, Regulations and Procedures of CISPR
- CISPR 11 Industrial, Scientific and Medical (ISM) Radio-Frequency Equipment
- CISPR 12 Vehicles, Motor Boats and Spark-Ignited Engine driven
- CISPR 13 Sound and Television Receivers
- CISPR 14 Household Electrical Appliances, Portable Tools and Similar Electrical Apparatus
- CISPR 15 Fluorescent Lamps and luminaries
- CISPR 16 Radio Interference Measuring Apparatus and Measurement Methods
- CISPR 17 Passive Radio Interference Filters and Suppression Components
- CISPR 18 Power Transmission Cables and High Voltage equipment
- CISPR 19 Microwave Ovens for Frequencies above 1GHz
- CISPR 20 Immunity of Sound and TV Broadcast Receivers Receivers and Associated Equipment
- CISPR 21 Interference to Mobile Radiocommunications in the Presence of Impulsive Noise
- CISPR 22 Information Technology Equipment
- CISPR 23 Industrial Scientific and Medical (ISM) Equipment
- CISPR 24 Immunity Regulation of Information Technology Equipment
- CISPR 25 Receiver used on board vehicles, boats, and on devices

4. Limits of VCCI Voluntary Regulation

(1)VCCI recommend measurement at 10m distance. 3m or 30m distance measurement are also allowed.

(2)Scope of VCCI Voluntary Regulation

This regulation applies to information technology equipment (same as CISPR Pub.22), but the application is excluded on the following equipment:

- Equipment for which other regulations already exist (e.g., household electrical appliances, radio and TV receivers)
- In station equipment principal purpose of which is electrical communication
- Industrial plant control system for which information processing is a secondary system function
- Industrial, commercial and medical testing and measuring systems for which data processing is a secondary system function
- Information equipment for which CISPR is conducting further deliberation

VCCI is the acronym of Voluntary Control Council for Interference by Data Processing Equipment and Electronic Office Machines.

VCCI is organized by the following organizations:

- Japan Electronics and Information Technology Industries Association (JEITA)
- Japan Business Machine and Information System Industries Association (JBMIA)
- Communication and Information network Association of Japan (CIAJ)

[Main Terminal Interference Voltage (Power Supply)]

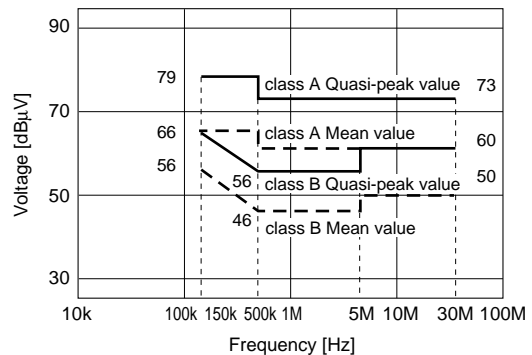

[Radiated Interference]

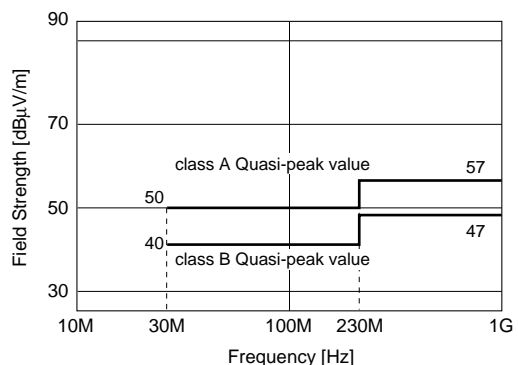

On the border frequency, lower limit should be applied.

Class B ITE : Equipment that designed to be used at home.
Class A ITE : Equipment that does not meet interference limits of class B equipment, but satisfies interference limits of class A equipment.

Continued on the following page. ☐

Outlines of Major Noise Regulation Standards

☐ Continued from the preceding page.

5. Limits of FCC Part 15 Subpart B

- (1) Class A recommend to be measured with 10m distance.
Class B recommend to be measured with 3m distance.
- (2) The FCC Part 15 regulation controls radiated interference by establishing quasi-peak and mean value limits for frequencies ranging from 30MHz to 40GHz (or maximum frequency's fifth harmonic, whichever is lower).
For AC main ports, the FCC Part 15 regulation controls main terminal interference voltage by establishing quasi-peak value limits for frequencies ranging from 450kHz to 30MHz.

Measurement Frequency Range for Radiated Interference

Maximum Frequency the Equipment Internally Generates, Uses or Operates or Synchronizes (MHz)	Upper End of Measurement Frequency Range (MHz)
Less than 1.705	30
1.705 to 108	1000
108 to 500	2000
500 to 1000	5000
Over 1000	Maximum Frequency's Fifth Harmonic or 40GHz, Whichever is Lower

[Main Terminal Interference Voltage (Power Supply)]

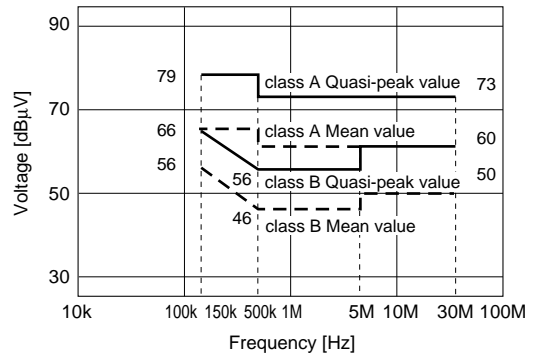

[Radiated Interference]

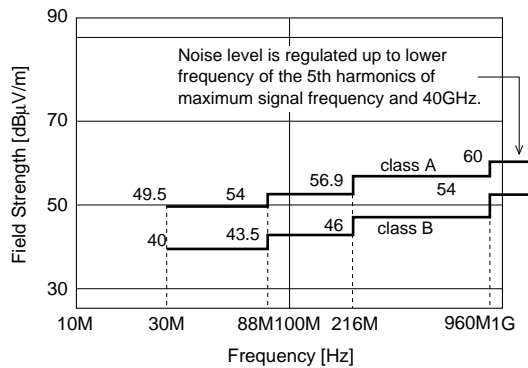

On the border frequency, lower limit should be applied.

Class A Equipment : The digital equipment that is sold to in the commercial, industrial and office use.

Class B Equipment : The digital equipment that is sold to be used in residential area.

- (3) There is no regulation on power interference.

[FCC Regulations]

- Part 1 Procedures
- Part 2 Frequency Division and Radio Wave Treaty Issues and General Rules
- Part 15 Radio Wave Equipment
 - Intentionally electromagnetic radiation equipment
 - Non-intentionally electromagnetic radiation equipment
 - Incidentally electromagnetic radiation equipment
- Part 18 Industrial, Scientific and Medical Equipment
- Part 22 Public Mobile Wireless Operations
- Part 68 Connecting Terminal Equipment to Telephone Circuit Network
- Part 76 Cable Television

Continued on the following page. ☐

Outlines of Major Noise Regulation Standards

☐ Continued from the preceding page.

6. Immunity Regulations in Europe Union

All electric/electronic equipment cannot be sold in Europe without CE marking. To use CE marking, they must satisfy related EC directives such as EMC directives. For Information Technology Equipment, in EMC directive, emission regulations are integrated, and immunity regulations are applied. Although these immunity regulations are prepared by CENELEC, almost all contents are same as standards issued by IEC or CISPR.

All products which are sold in EU must satisfy EC directive which contains immunity regulation.

Principal EC Directive	
EMC Directive	89/336/EEC 92/31/EEC
Low-Voltage Electrical Products Directive	73/23/EEC
Machines Directive	89/392/EEC

7. Immunity Regulations in Japan

Equipment	Association
TV, Radio, Audio	JEITA (Japan Electronics and Information Technology)
ITE	
Office Machine	JBMA (Japan Business Machine and Information System Industries Association)
Mi	CIAJ (Communication and Information network Association of Japan) ARIB (Association of Radio Industries and Business)
Machine To Builders	JMTBA (Japan Machine Tool Builders' Association)
Industrial Measuring Control Equipment	JEMIMA (Japan Electric Measuring Instruments Manufacturers' Association)
Industrial Robot	JARA (Japan Robot Association)

The table on the right shows the preparation situation of JIS for EMC. At this moment, the immunity standards by JIS does not have a legal force like Electrical Application and Material Safety Law/VCCI.

Classification	Information Regulation	JIS
Terms	ISO60050-161 (IEV terms 161)	JIS C 0161
Basic Standard	IEC61000-4- 2	JIS C 1000-4-2
	IEC61000-4- 3	JIS C 1000-4-3
	IEC61000-4- 4	JIS C 1000-4-4
	IEC61000-4- 5	JIS C 1000-4-5
	IEC61000-4- 6	JIS C 1000-4-6
	IEC61000-4- 7	JIS C 1000-4-7
	IEC61000-4- 8	} Under preparation
	IEC61000-4-11	
	IEC61000-4-14	
	IEC61000-4-17	
Generic Standard	IEC61000-6-1	}
	IEC61000-6-2	

Noise Suppression Principles by DC EMIFIL®

1. Function of DC EMI Suppression Filters

DC EMI suppression filters absorb and eliminate high frequency noise which may produce electromagnetic interference in PC board circuits.

These filters are used in secondary circuits, and are small in size and light in weight, which further enhances their excellent noise suppression functions.

Chip and adhesive type filters can be mounted on PC boards automatically.

These filters are effective in the suppression of radiation noise in computers, peripheral equipment, and digital circuit application equipment (including various types of microcomputer application equipment), and function to suppress noise in audio/visual equipment, which uses digital memory chips and DSP.

These filters are also effective for improving the noise immunity of equipment used in noisy environments (such as electronic equipment for automobiles).

2. Noise Filter Suppression Principles

Generally, noise problems occur when the noise source and electronic equipment sensitive to the influence of noise are located in close proximity to one another.

In such situations, as shown in Figure at right, noise is conducted through a conductor, which produces an inductive field around the noise source.

To overcome such noise problems, it is preferable to reduce the amount of noise generated by the noise source or improve the noise resistance of adjacent equipment.

In order to satisfy equipment performance specifications and eliminate noise effectively at the same time, however, it is customary to reduce the amount of noise generated by the noise source, if it can't be eliminated altogether.

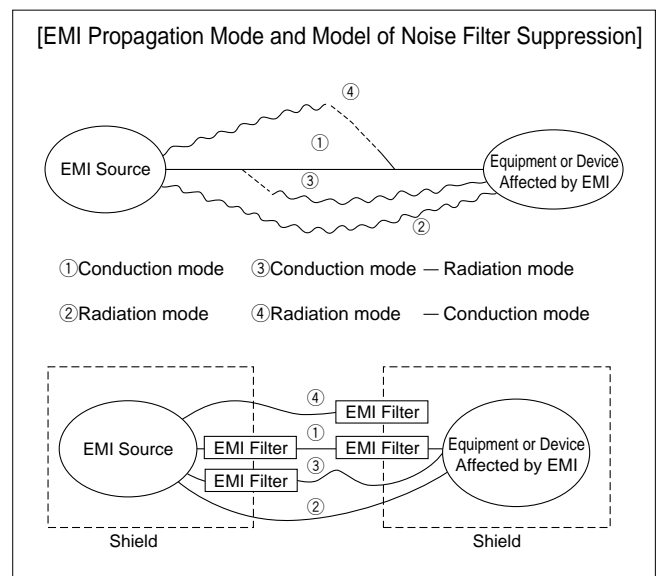

3. Configuration of EMI Suppression Filters (DC)

DC EMI suppression filters are used to suppress noise produced by conductors. Noise radiation can be suppressed, if it is eliminated with a filter in advance.

Generally, such noise suppression is achieved with DC EMI suppression filters, according to the capacitive and inductive frequency characteristics of the respective conductors in the circuit.

Filters of this kind can be roughly divided into those :

- (1) employing a capacitor,
- (2) employing an inductor,
- (3) employing a capacitor and inductor combination.

Continued on the following page.

Noise Suppression Principles by DC EMIFIL[®]

☐ Continued from the preceding page.

4. Capacitive Noise Suppression

When a capacitor is connected (bypass capacitor) to ground from a noisy signal line or power line, the circuit impedance decreases as the frequency increases. Since noise is a high frequency phenomenon, it flows to ground if a capacitor has been connected to ground, thereby making it possible to eliminate noise. (See Fig.) EMI suppression filters employing a capacitor in this way are used to eliminate this type of noise.

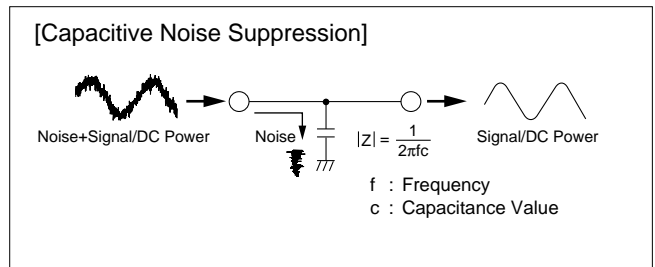

5. High frequency Capacitor Characteristics Used for EMI Suppression Filters

Even general-purpose capacitors can be used for noise suppression. However, since noise has an extremely high frequency range, general-purpose capacitors may not function as effective bypass capacitors, due to the large residual inductance built into the capacitor.

All the capacitors used in MURATA's EMI suppression filters employ a 3 terminal structure or thru-type structure, which functions effectively even at high frequencies, thereby minimizing the influence of residual inductance. Consequently, an effective filter circuit can be formed even at frequencies exceeding 1GHz. (Refer to Fig.)

[Equivalent circuit of general-purpose capacitor and 3 terminal capacitor in the high frequency area and comparison of insertion loss]

(a) Construction of capacitor

2-terminal capacitor

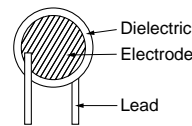

3-terminal capacitor

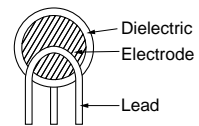

(b) Equivalent circuit of capacitors which is concerning ESL effect.

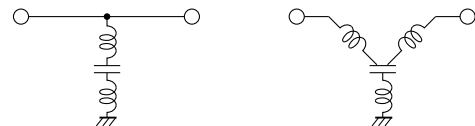

(c) Improvement of Insertion Loss Characteristics

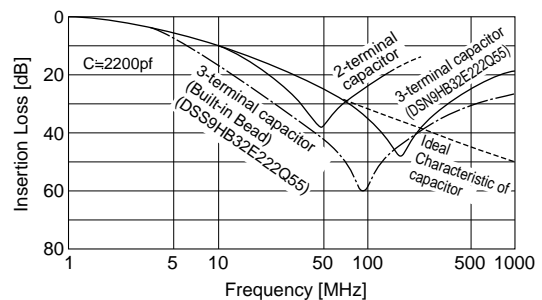

6. Inductive Noise Suppression

When an inductor is inserted in series in a noise producing circuit (See Fig.), its impedance increases with frequency. In this configuration it is possible to attenuate and eliminate noise components (high frequency components). The MURATA EMI suppression filter functions in this way.

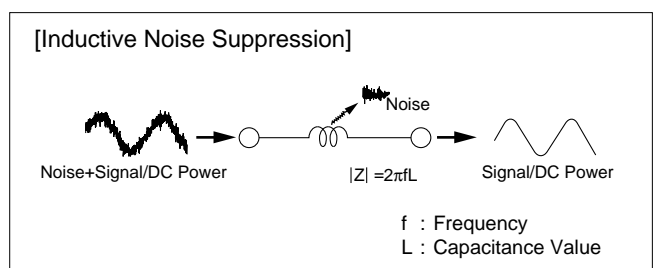

Continued on the following page. ☐

Noise Suppression Principles by DC EMIFIL[®]

☐ Continued from the preceding page.

7. Characteristics of Inductors Used in EMI Suppression Filters

General-purpose inductors also function to suppress noise when configured in series with a noise producing circuit. However, when general-purpose inductors are used, resonance may result in peripheral circuits, signal wave forms may become distorted, and satisfactory impedance may not be obtained at noise frequencies (due to insufficient high frequency impedance characteristics).

The inductors used for MURATA's EMI suppression filters are designed to function nearly as a resistor at noise frequencies, which greatly reduces the possibility of resonance and leaves signal wave forms undistorted. And since sufficient impedance is obtained for frequencies ranging to hundreds of MHz, these specifically designed inductors operate effectively to suppress high-frequency noise. (See Fig.)

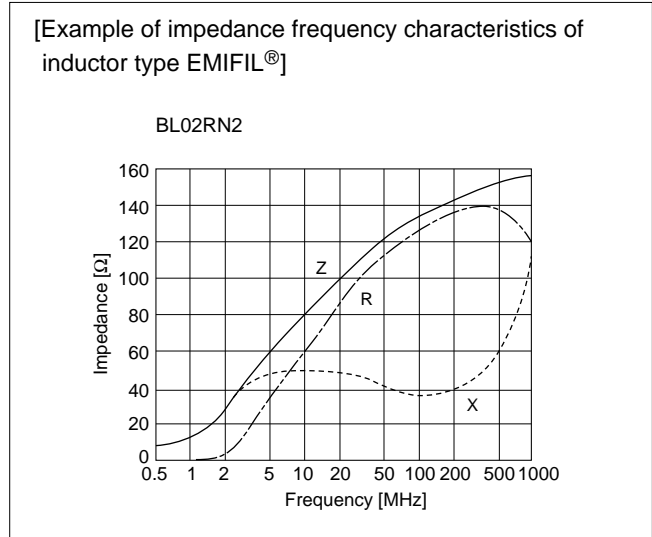
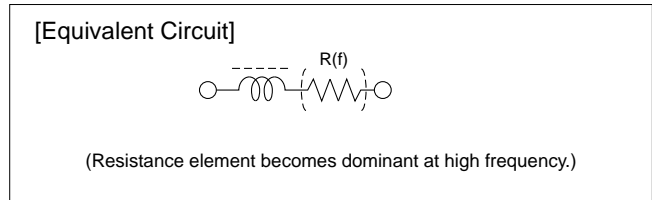

8. Capacitive-Inductive EMI Suppression Filters

If capacitive and inductive suppression characteristics are combined, it is possible to configure a much higher performance filter. In signal circuit applications where this combination is applied, noise suppression effects which have little influence on the signal wave form become possible.

This type of filter is also effective in the suppression of high-speed signal circuit noise. When used in DC power circuits, capacitive-inductive filters prevent resonance from occurring in peripheral circuits, thus making it possible to achieve significant noise suppression under normal service conditions.

9. Other EMI Suppression Filters

In addition to the capacitive-inductive filter, MURATA also has an EMI suppression filter (EMIGUARD[®]) combining a capacitor with a varistor, useful for surge absorption; and a common mode choke coil effective, for common mode noise suppression.

MURATA also has a range of built-in filter connectors which greatly reduce filter mounting space requirements.

Continued on the following page. ☐

Noise Suppression Principles by DC EMIFIL[®]

☑ Continued from the preceding page.

10. Expressing EMI Suppression Filter Effects

EMI Suppression Filter effects are expressed in terms of the insertion loss measured in the circuit, normally specified in MIL-STD 220A. As shown in the 50Ω impedance circuit in the Figure at right, insertion loss is represented by the logarithmic ratio of the circuit output voltage with and without a filter in the circuit, which is multiplied by 20 and expressed in dB.

Therefore, an insertion loss of 20dB indicates an output voltage ratio (B/C) of 1/10, and an insertion loss of 40dB indicates an output voltage ratio (B/C) of 1/100.

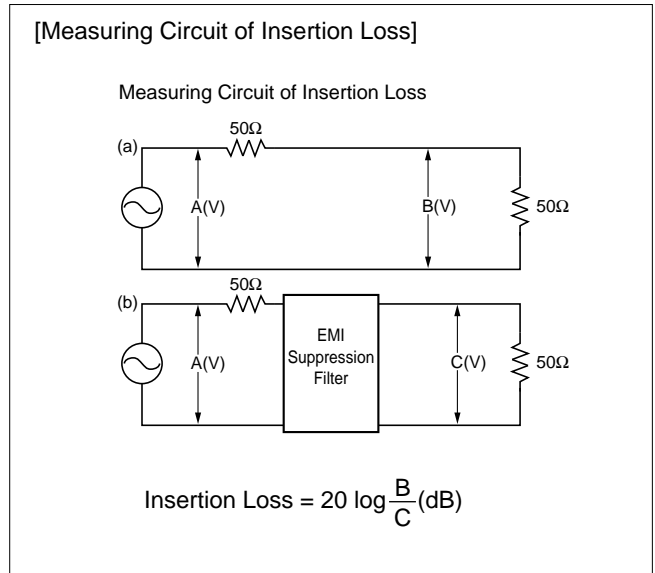



Murata EMI Filter Selection Simulator Ver.2.5.0

— Recommended Chip Ferrite Beads Search procedure has been added —

1 Select circuit.

(Select a new simulation circuit from File menu.)

2 Enter "Input Signal".

3 Set Driver IC.

4 Select filter.

(EMI filters or/and chip capacitor from the pull-down list.)

5 Set Transmission Line.

6 Set Receiver IC.

7 Click measuring point.

(Only for chip ferrite bead)

8 Click "Start Simulation" button.

9 Simulation results are displayed.

- Simulation results with various charts are quickly displayed on your PC.
- Results can be displayed in standard format or user defined scaling.
- Simulates various types of circuit such as Differential Mode Transmission, ceramic capacitor, EMIFIL® three terminal capacitor AND chip ferrite beads.
- Provides a simulation function that select best suited Chip Ferrite Beads.

1 Select circuit.



Select a new simulation circuit from File menu.

4 Filters can be selected from "frequency-impedance characteristics" charts.

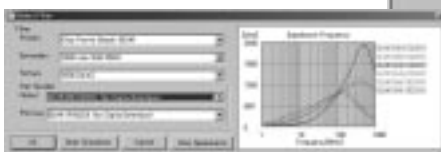

9 Simulation results are shown in the window.

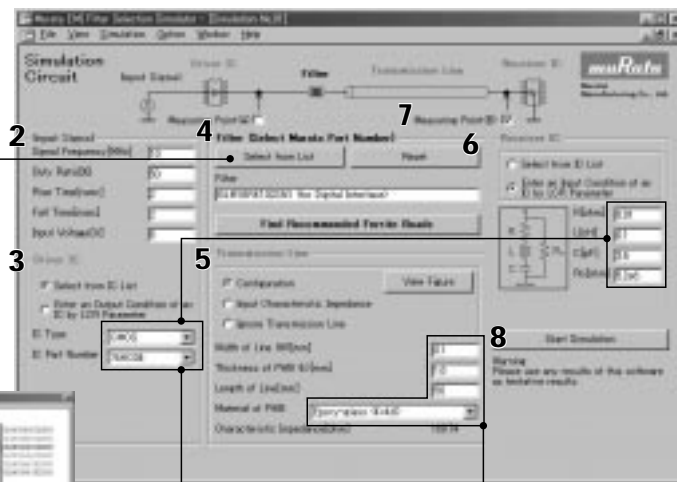
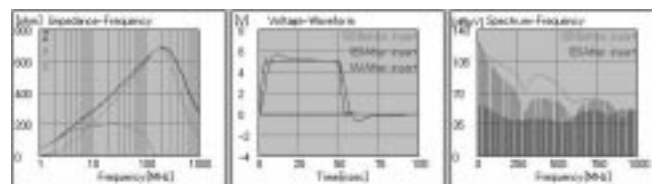

Two ways of setting the driver/receiver IC parameter
The logic IC of TTL and CMOS can be selected from pull-down list or the LCR values can also be created.

Impedance automatically calculated.
Impedance characteristics of transmission line are automatically calculated.

Find Recommended Ferrite Beads **NEW**

The software will recommend the most appropriate ferrite beads solution based on specified search condition.

The recommended parts will be displayed along with electrical characteristics, the voltage waveform and spectrum chart.

EMIFIL® is the trademark of Murata Manufacturing Co., Ltd.

This simulator can be downloaded from Murata web site.

<http://www.murata.com/emi/>

⚠Note:

1. Export Control
 <For customers outside Japan>
 Murata products should not be used or sold for use in the development, production, stockpiling or utilization of any conventional weapons or mass-destructive weapons (nuclear weapons, chemical or biological weapons, or missiles), or any other weapons.
 <For customers in Japan>
 For products which are controlled items subject to the "Foreign Exchange and Foreign Trade Law" of Japan, the export license specified by the law is required for export.
2. Please contact our sales representatives or product engineers before using the products in this catalog for the applications listed below, which require especially high reliability for the prevention of defects which might directly damage to a third party's life, body or property, or when one of our products is intended for use in applications other than those specified in this catalog.
 - ① Aircraft equipment
 - ② Aerospace equipment
 - ③ Undersea equipment
 - ④ Power plant equipment
 - ⑤ Medical equipment
 - ⑥ Transportation equipment (vehicles, trains, ships, etc.)
 - ⑦ Traffic signal equipment
 - ⑧ Disaster prevention / crime prevention equipment
 - ⑨ Data-processing equipment
 - ⑩ Application of similar complexity and/or reliability requirements to the applications listed in the above
3. Product specifications in this catalog are as of January 2003. They are subject to change or our products in it may be discontinued without advance notice. Please check with our sales representatives or product engineers before ordering. If there are any questions, please contact our sales representatives or product engineers.
4. Please read rating and ⚠CAUTION (for storage, operating, rating, soldering, mounting and handling) in this catalog to prevent smoking and/or burning, etc.
5. This catalog has only typical specifications because there is no space for detailed specifications. Therefore, please approve our product specifications or transact the approval sheet for product specifications before ordering.
6. Please note that unless otherwise specified, we shall assume no responsibility whatsoever for any conflict or dispute that may occur in connection with the effect of our and/or a third party's intellectual property rights and other related rights in consideration of your use of our products and/or information described or contained in our catalogs. In this connection, no representation shall be made to the effect that any third parties are authorized to use the rights mentioned above under licenses without our consent.
7. No ozone depleting substances (ODS) under the Montreal Protocol are used in our manufacturing process.