

Multilayer Diplexers, DPX Series

DPX161990DT-8003B1

SHAPES AND DIMENSIONS/CIRCUIT

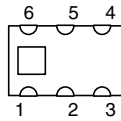
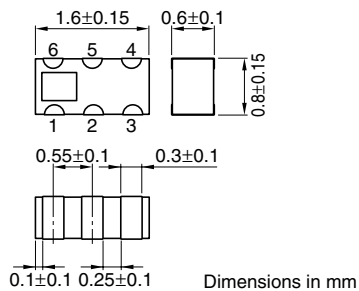

TERMINAL FUNCTIONS

1	GND
2	ANT
3	GND
4	HIGH
5	GND
6	LOW

RECOMMENDED PCB PATTERN

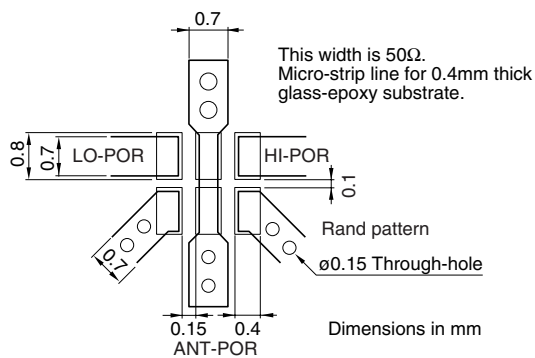

ELECTRICAL CHARACTERISTICS

Item	Port	Frequency range	Minimum value	Typical value	Maximum value
Insertion loss	Lo-band	824 to 960MHz	(dB) —	—	0.7
	Hi-band	1710 to 1990MHz	(dB) —	—	0.85
Return loss	ANT	824 to 960MHz	(dB) 10.0	—	—
	ANT	1710 to 1990MHz	(dB) 10.0	—	—
Attenuation	Hi-band	824 to 960MHz	(dB) 17.0	—	—
	Lo-band	1710 to 1990MHz	(dB) 15.0	—	—
Temperature range		Operating	(°C) -40	—	+85°C
		Storage	(°C) -40	—	+85°C

• Ta: +25°C

FREQUENCY CHARACTERISTICS

Lo-BAND PORT S21

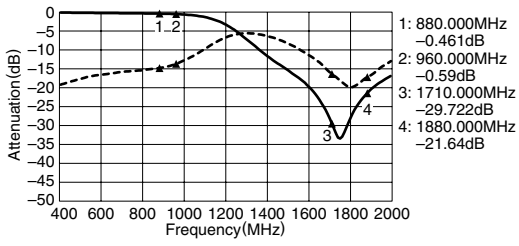

Hi-BAND PORT S31

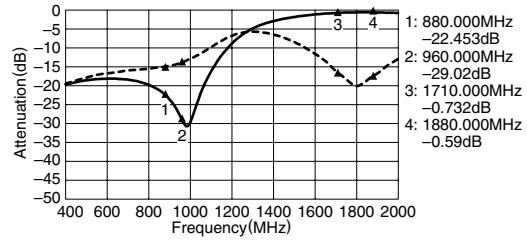

COMMON PORT RETURN LOSS S11

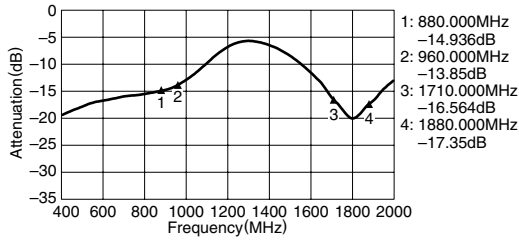

ISORATION S23

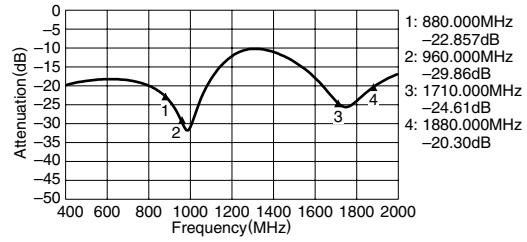

Lo-BAND PORT RETURN LOSS S22

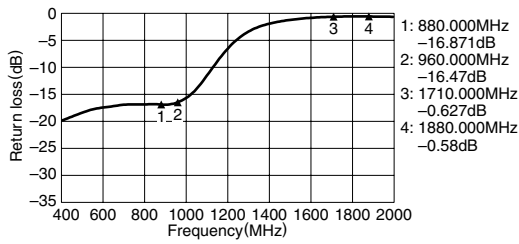

Hi-PORT RETURN LOSS S33

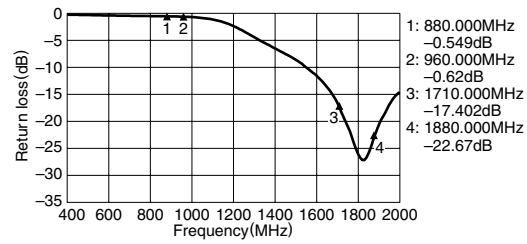

SMITH CHART

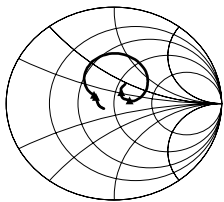

S11

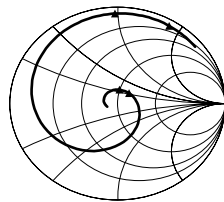

S22

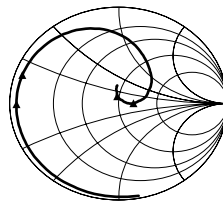

S33

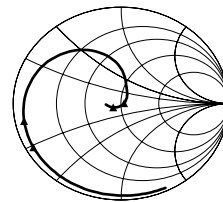

S21

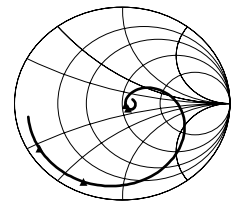

S31

Multilayer Diplexers, DPX Series

DPX201578DT-4017A1

SHAPES AND DIMENSIONS/CIRCUIT

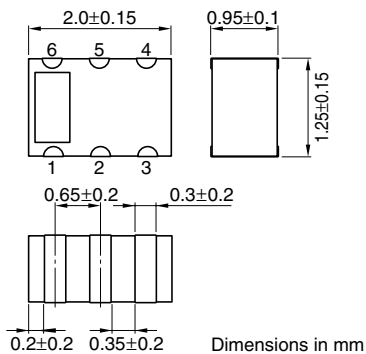

TERMINAL FUNCTIONS

1	GND
2	ANT
3	GND
4	HIGH
5	GND
6	LOW

RECOMMENDED PCB PATTERN

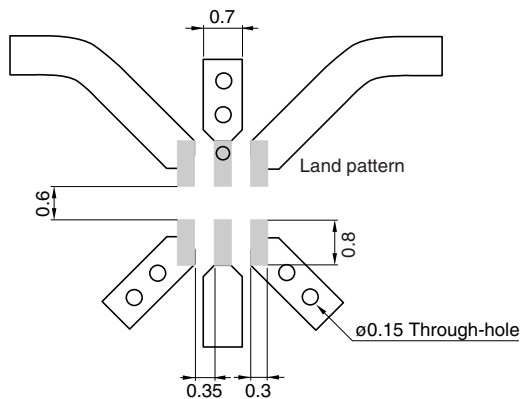

Line width be designed to match 50Ω characteristic impedance depending on PCB material and thickness.

ELECTRICAL CHARACTERISTICS

Item	Port	Frequency range	Minimum value	Typical value	Maximum value
Insertion loss	Lo-band	823 to 925MHz (dB)	—	—	0.55
	Lo-band	[−40 to +85°C] 823 to 925MHz (dB)	—	—	0.65
	Hi-band	1572.5 to 1578.5MHz (dB)	—	—	0.60
	Hi-band	[−40 to +85°C] 1572.5 to 1578.5MHz (dB)	—	—	0.70
VSWR	ANT	823 to 925MHz	—	—	1.60
	ANT	1572.5 to 1578.5MHz	—	—	1.60
	Lo-band	823 to 925MHz	—	—	1.60
Attenuation	Hi-band	823 to 925MHz (dB)	25.0	—	—
	Lo-band	1572.5 to 1578.5MHz (dB)	23.0	—	—
Temperature range	Operating	(°C)	−40	—	+85°C
	Storage	(°C)	−40	—	+85°C

• Ta: +25°C

FREQUENCY CHARACTERISTICS

Lo-BAND PORT S21

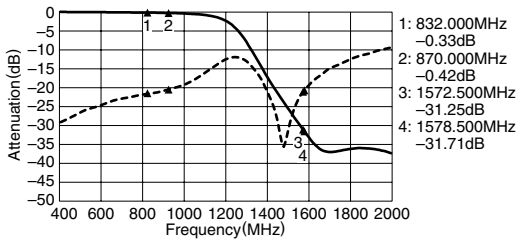

Hi-BAND PORT S31

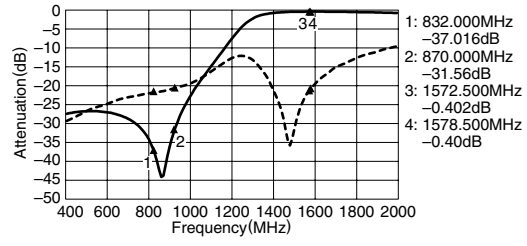

COMMON PORT RETURN LOSS S11

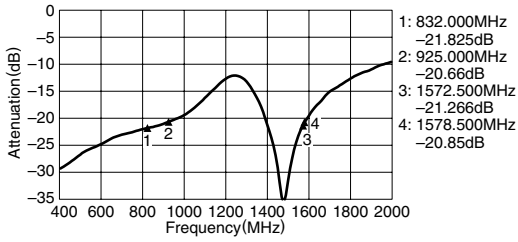

ISORATION S23

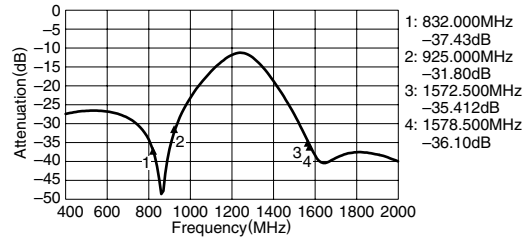

Lo-BAND PORT RETURN LOSS S22

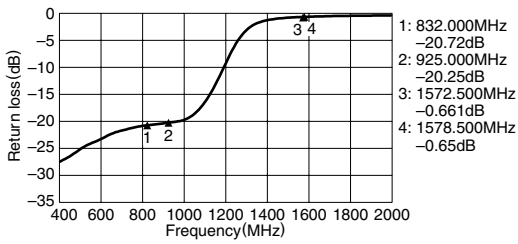

Hi-PORT RETURN LOSS S33

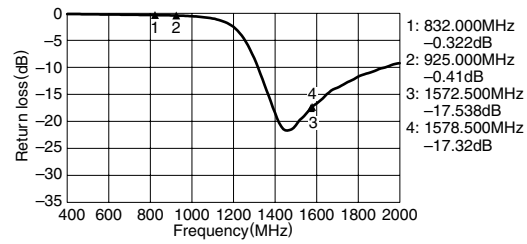

SMITH CHART

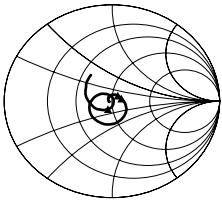

S11

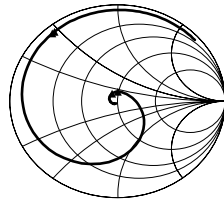

S22

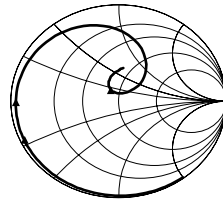

S33

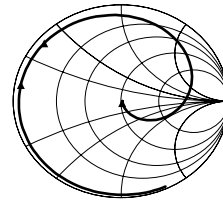

S21

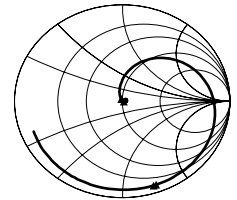

S31

Multilayer Diplexers, DPX Series

DPX201990DT-4011D1

SHAPES AND DIMENSIONS/CIRCUIT

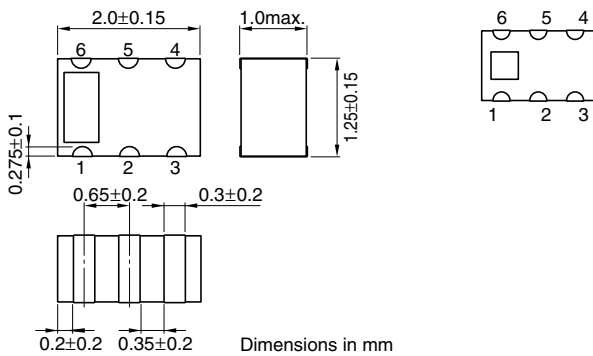

TERMINAL FUNCTIONS

1	GND
2	ANT
3	GND
4	HIGH
5	GND
6	LOW

RECOMMENDED PCB PATTERN

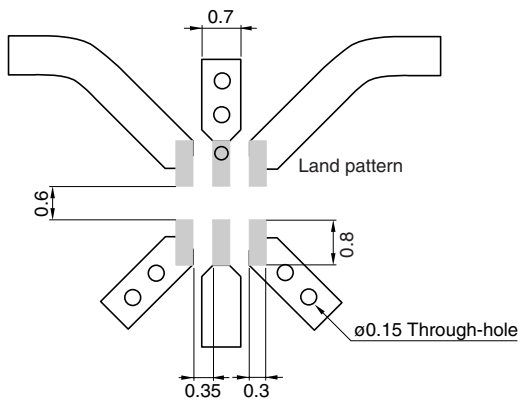

Line width be designed to match 50Ω characteristic impedance depending on PCB material and thickness.

Dimensions in mm

ELECTRICAL CHARACTERISTICS

Item	Port	Frequency range		Minimum value	Typical value	Maximum value
Insertion loss	Lo-band	824 to 960MHz	(dB)	—	—	0.5
	Hi-band	1710 to 1990MHz	(dB)	—	—	0.55
Return loss	ANT	824 to 960MHz	(dB)	10.0	—	—
	ANT	1710 to 1990MHz	(dB)	10.0	—	—
Attenuation	Hi-band	824 to 960MHz	(dB)	20.0	—	—
	Lo-band	1710 to 1990MHz	(dB)	20.0	—	—
Temperature range		Operating	(°C)	-40	—	+85°C
		Storage	(°C)	-40	—	+85°C

• Ta: +25°C

FREQUENCY CHARACTERISTICS

Lo-BAND PORT S21

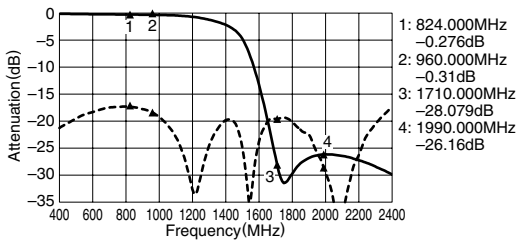

Hi-BAND PORT S31

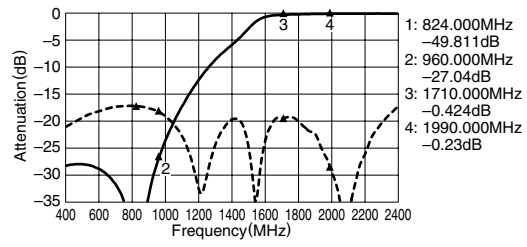

COMMON PORT RETURN LOSS S11

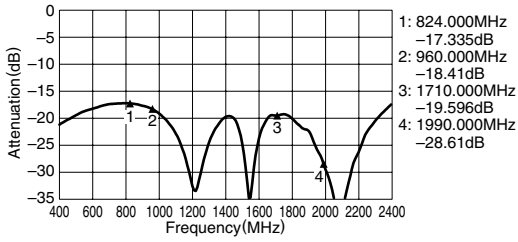

ISORATION S23

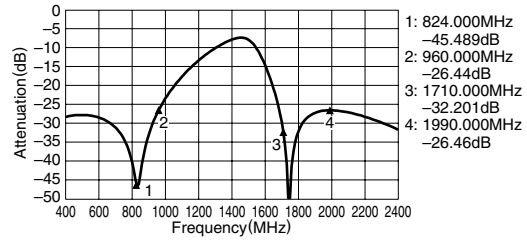

Lo-BAND PORT RETURN LOSS S22

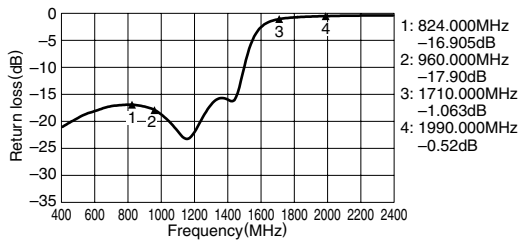

Hi-PORT RETURN LOSS S33

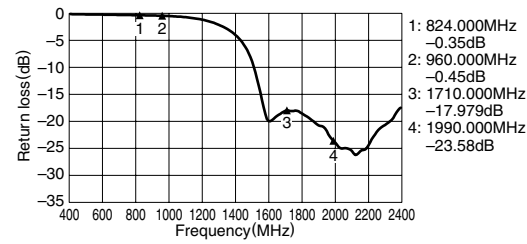

SMITH CHART

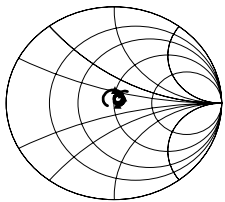

S11

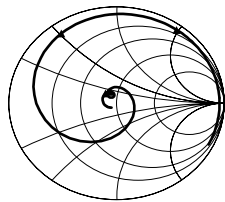

S22

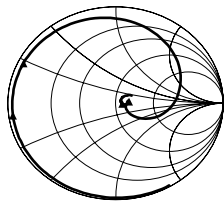

S33

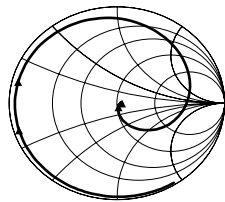

S21

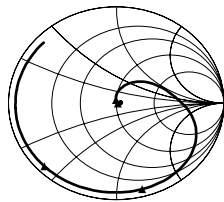

S31

Multilayer Diplexers, DPX Series

DPX201990DT-4012A1

SHAPES AND DIMENSIONS/CIRCUIT

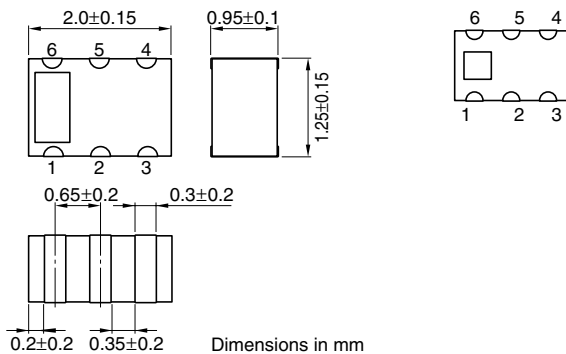

TERMINAL FUNCTIONS

1	GND
2	ANT
3	GND
4	HIGH
5	GND
6	LOW

RECOMMENDED PCB PATTERN

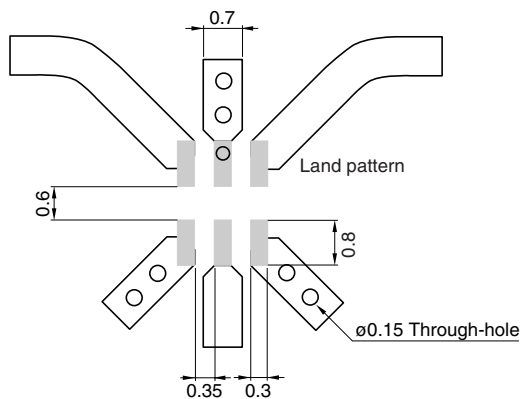

Line width be designed to match 50Ω characteristic impedance depending on PCB material and thickness.

Dimensions in mm

ELECTRICAL CHARACTERISTICS

Item	Port	Frequency range	Minimum value	Typical value	Maximum value
Insertion loss	Lo-band	824 to 894MHz	(dB) —	—	0.65
	Hi-band	1574 to 1576ÅA1850 to 1990MHz	(dB) —	—	0.7
Return loss	ANT	824 to 894MHz	(dB) 10.0	—	—
	ANT	1574 to 1576ÅA1850 to 1990MHz	(dB) 10.0	—	—
Attenuation	Hi-band	824 to 894MHz	(dB) 20.0	—	—
	Lo-band	1574 to 1576ÅA1850 to 1990MHz	(dB) 20.0	—	—
Temperature range	Operating	(°C)	−40	—	+85°C
	Storage	(°C)	−40	—	+85°C

• Ta: +25°C

FREQUENCY CHARACTERISTICS

Lo-BAND PORT S21

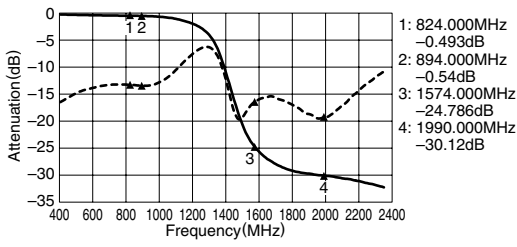

Hi-BAND PORT S31

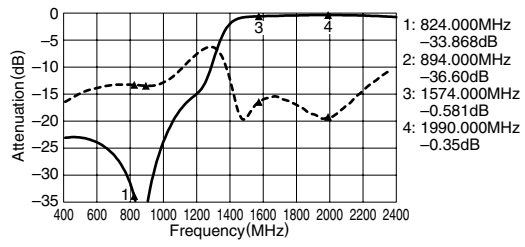

COMMON PORT RETURN LOSS S11

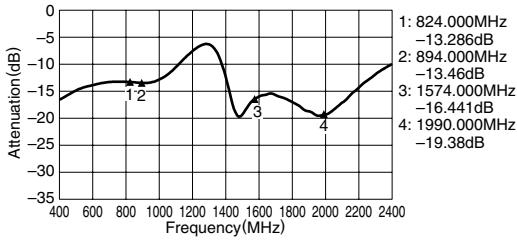

ISORATION S23

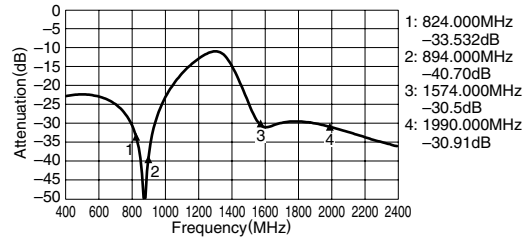

Lo-BAND PORT RETURN LOSS S22

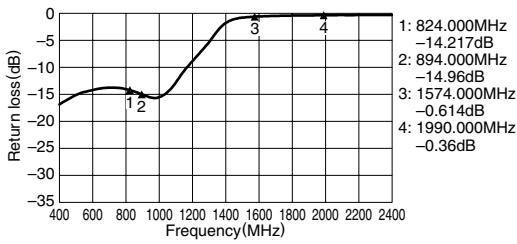

Hi-PORT RETURN LOSS S33

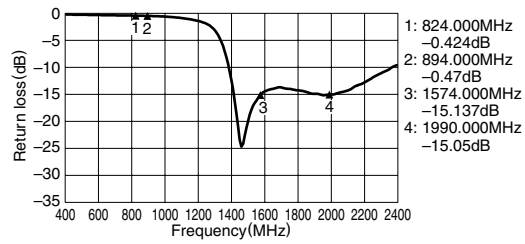

SMITH CHART

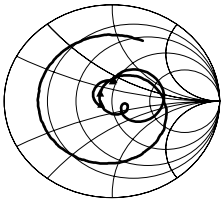

S11

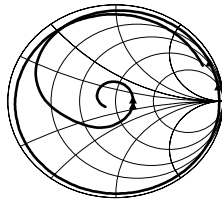

S22

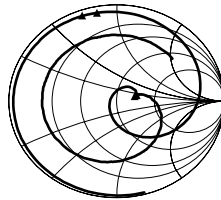

S33

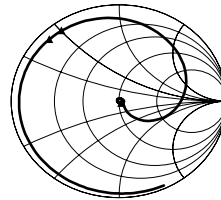

S21

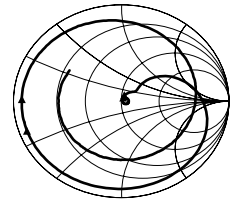

S31

Multilayer Diplexers, DPX Series

DPX202170DT-4021A1

SHAPES AND DIMENSIONS/CIRCUIT

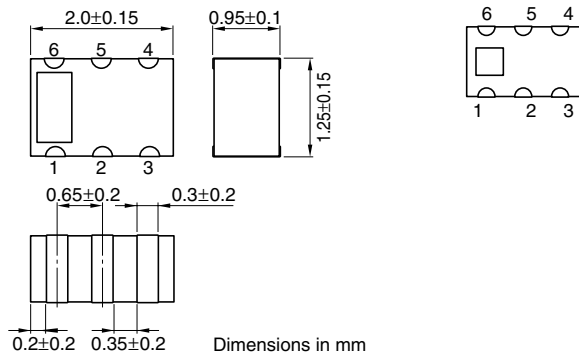

TERMINAL FUNCTIONS

1	GND
2	ANT
3	GND
4	HIGH
5	GND
6	LOW

RECOMMENDED PCB PATTERN

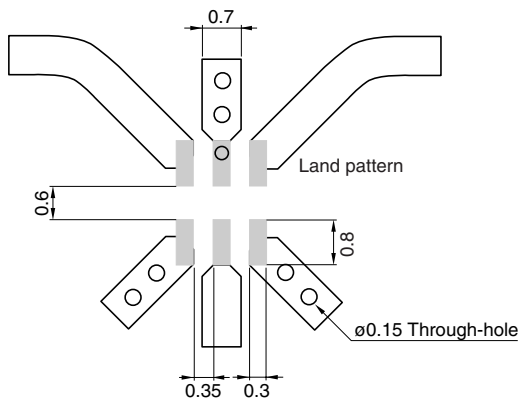

Line width be designed to match 50Ω characteristic impedance depending on PCB material and thickness.

Dimensions in mm

ELECTRICAL CHARACTERISTICS

Item	Port	Frequency range		Minimum value	Typical value	Maximum value
Insertion loss	Lo-band	830 to 885MHz	(dB)	—	—	0.5
	Hi-band	1920 to 2170MHz	(dB)	—	—	0.5
Return loss	ANT	830 to 885MHz 1920 to 2170MHz	(dB)	10.0	—	—
Attenuation	Hi-band	830 to 885MHz	(dB)	20.0	—	—
	Lo-band	1920 to 2170MHz	(dB)	20.0	—	—
Temperature range		Operating	(°C)	-40	—	+85°C
		Storage	(°C)	-40	—	+85°C

• Ta: +25°C

FREQUENCY CHARACTERISTICS

Lo-BAND PORT S21

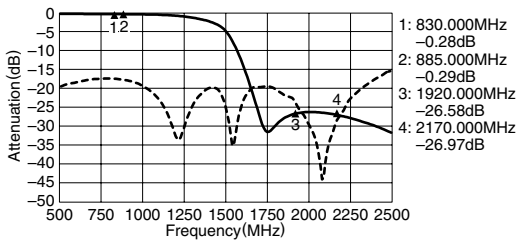

Hi-BAND PORT S31

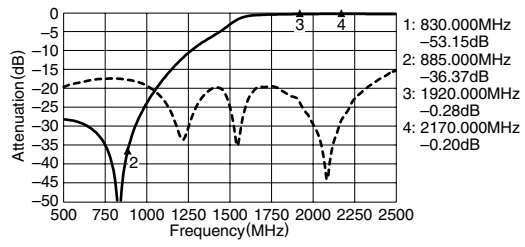

COMMON PORT RETURN LOSS S11

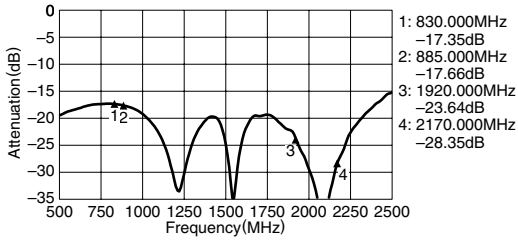

ISORATION S23

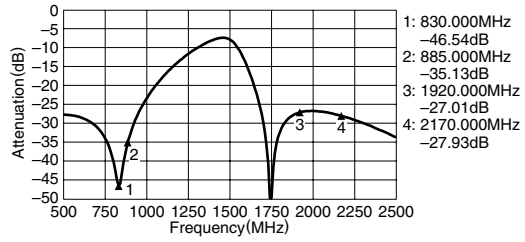

Lo-BAND PORT RETURN LOSS S22

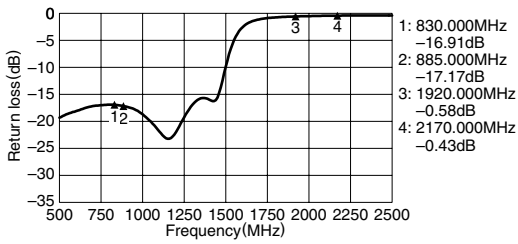

Hi-PORT RETURN LOSS S33

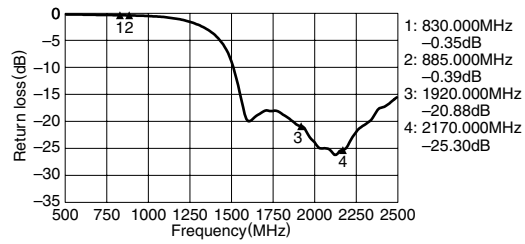

SMITH CHART

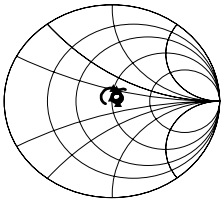

S11

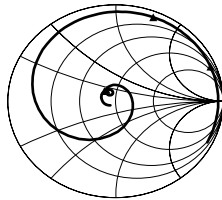

S22

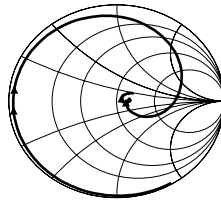

S33

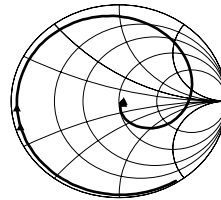

S21

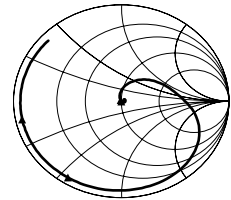

S31

Multilayer Diplexers, DPX Series

DPX205950DT-9008A1

SHAPES AND DIMENSIONS/CIRCUIT

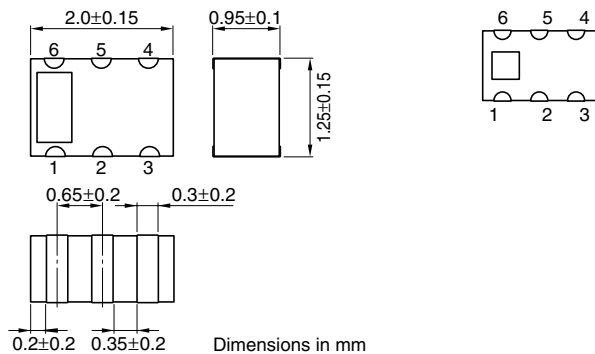

TERMINAL FUNCTIONS

1	GND
2	ANT (COMMON)
3	GND
4	HIGH (5.0GHz)
5	GND
6	LOW (2.4GHz)

RECOMMENDED PCB PATTERN

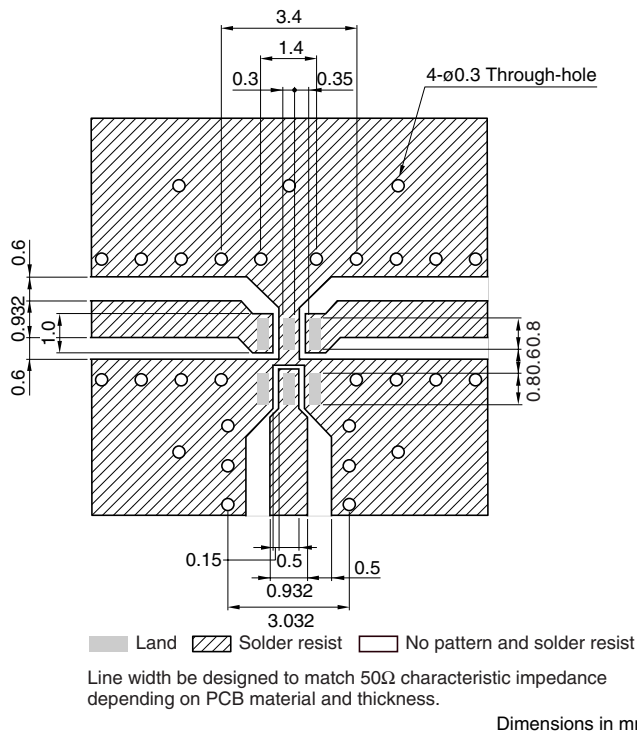

ELECTRICAL CHARACTERISTICS

Item	Port	Frequency range	Minimum value	Typical value	Maximum value
Insertion loss	ANT-LOW	[25±5°C]	2300 to 2500MHz (dB)	—	0.45
		[-40 to +85°C]	2300 to 2500MHz (dB)	—	0.8
	ANT-HIGH	[25±5°C]	4900 to 5950MHz (dB)	—	0.90
		[-40 to +85°C]	4900 to 5950MHz (dB)	—	1.6
Attenuation	ANT-LOW	4600 to 5000MHz (dB)	20	23	—
		6900 to 7500MHz (dB)	20	26	—
	ANT-HIGH	2300 to 2500MHz (dB)	20	24	—
Return loss	ANT	9800 to 11900MHz (dB)	13	20	—
		2300 to 2500MHz (dB)	10	20	—
	LOW	4900 to 5950MHz (dB)	9	11	—
		2400 to 2500MHz (dB)	10	20	—
Temperature range	HIGH	4900 to 5950MHz (dB)	9	11	—
		Operating (°C)	-40	—	+85°C
		Storage (°C)	-40	—	+85°C

• Ta: +25°C

• All specifications are subject to change without notice.

FREQUENCY CHARACTERISTICS

ANT-LOW S11

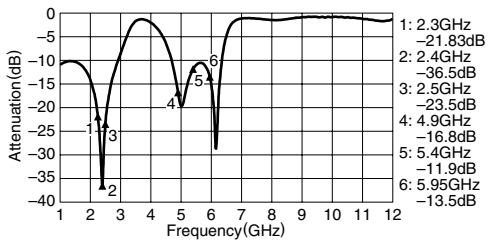

S21

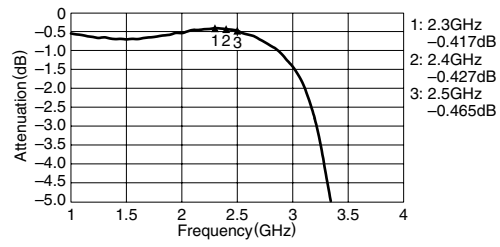

S21

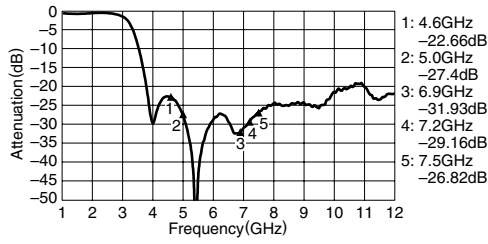

S22

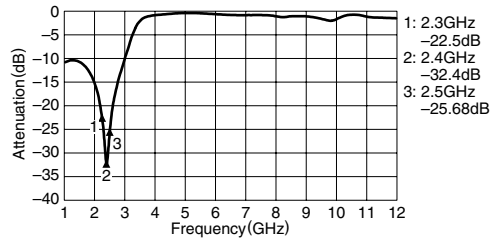

ANT-HIGH S11

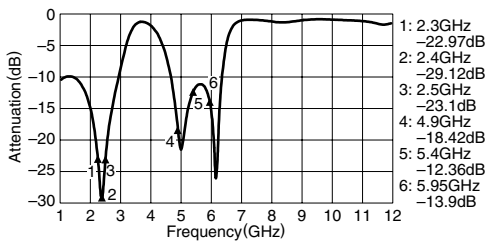

S21

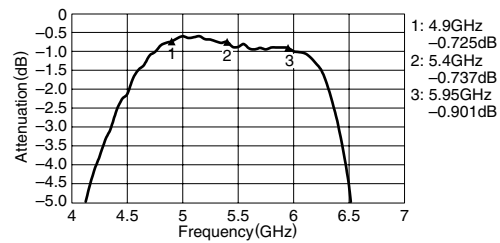

S21

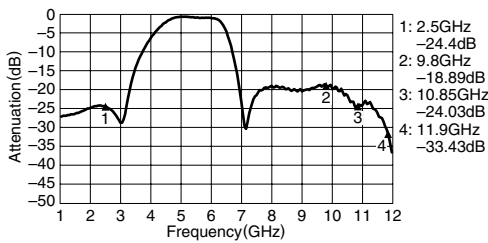

S22

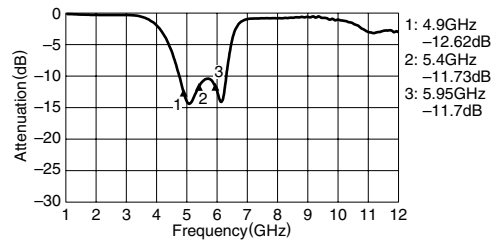

• All specifications are subject to change without notice.

Multilayer Diplexers, DPX Series

DPX205950DT-9108A1

SHAPES AND DIMENSIONS/CIRCUIT

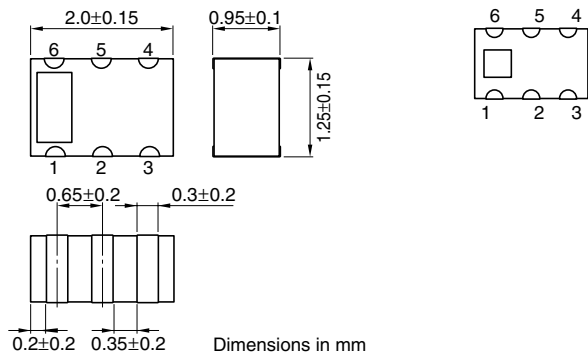

TERMINAL FUNCTIONS

1	GND
2	ANT (COMMON)
3	GND
4	LOW (2.4GHz)
5	GND
6	HIGH (5.0GHz)

RECOMMENDED PCB PATTERN

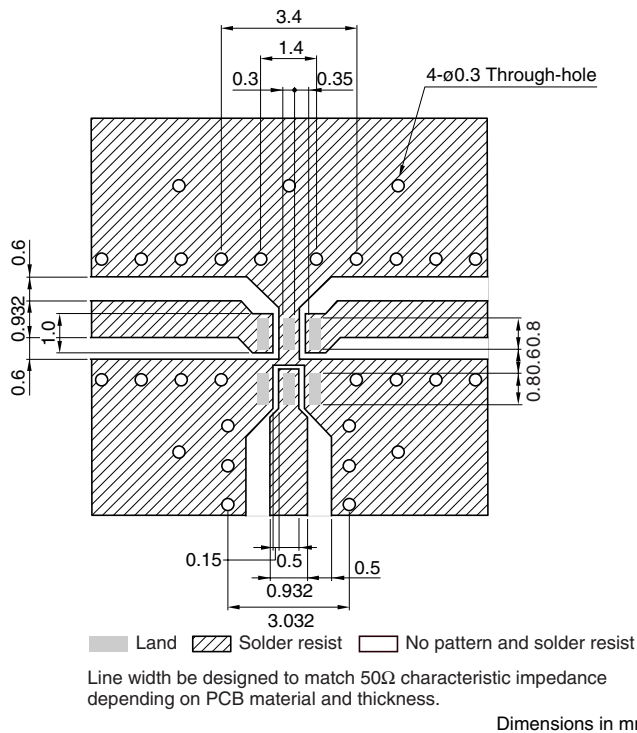

ELECTRICAL CHARACTERISTICS

Item	Port	Frequency range	Minimum value	Typical value	Maximum value
Insertion loss	ANT-LOW	[25±5°C]	2300 to 2500MHz (dB)	—	0.45
		[-40 to +85°C]	2300 to 2500MHz (dB)	—	0.8
	ANT-HIGH	[25±5°C]	4900 to 5950MHz (dB)	—	0.90
		[-40 to +85°C]	4900 to 5950MHz (dB)	—	1.6
Attenuation	ANT-LOW	4600 to 5000MHz (dB)	20	23	—
		6900 to 7500MHz (dB)	20	26	—
	ANT-HIGH	2300 to 2500MHz (dB)	20	24	—
		9800 to 11900MHz (dB)	13	24	—
Return loss	ANT	2300 to 2500MHz (dB)	10	20	—
	ANT	4900 to 5950MHz (dB)	9	12	—
	LOW	2400 to 2500MHz (dB)	10	20	—
	HIGH	4900 to 5950MHz (dB)	9	11	—
Temperature range	Operating	(°C)	-40	—	+85°C
	Storage	(°C)	-40	—	+85°C

• Ta: +25°C

• All specifications are subject to change without notice.

FREQUENCY CHARACTERISTICS

ANT-LOW S11

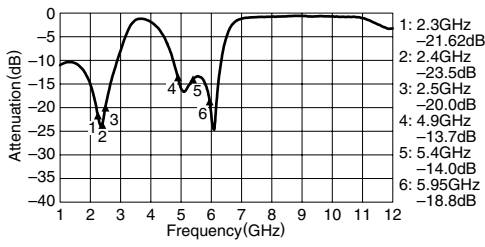

S21

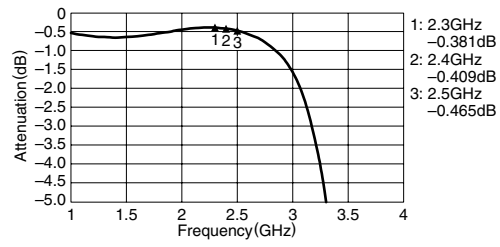

S21

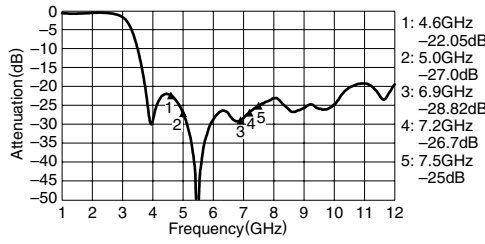

S22

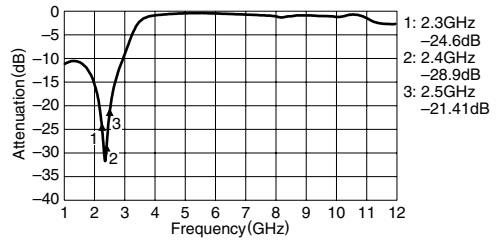

ANT-HIGH S11

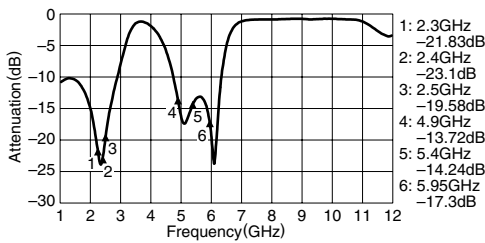

S21

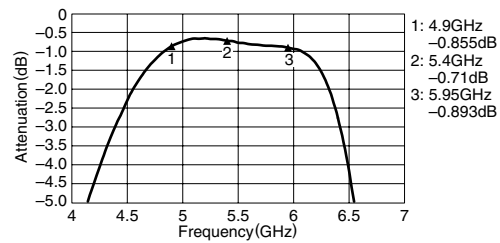

S21

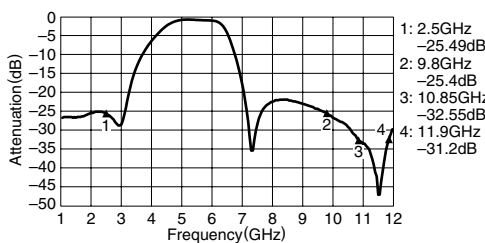

S22

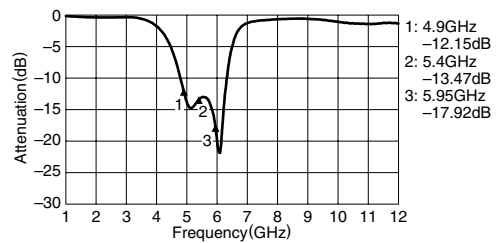

• All specifications are subject to change without notice.

Multilayer Diplexers, DPX Series

DPX315950DT-5005B2 For 2.4/5GHz W-LAN

SHAPES AND DIMENSIONS

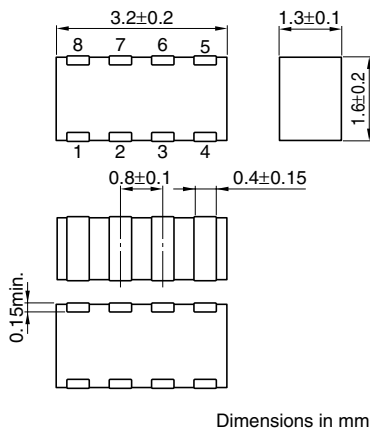

TERMINAL FUNCTIONS

1	HIGH (5.0GHz)
2	GND
3	GND
4	LOW (2.4GHz)
5	GND
6	ANT (COMMON)
7	GND
8	GND

RECOMMENDED PCB PATTERN

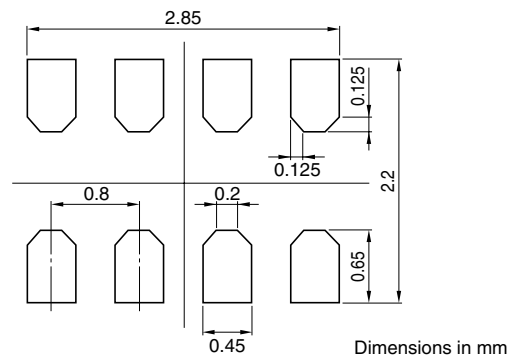

ELECTRICAL CHARACTERISTICS

Item	Port		Frequency range		Minimum value	Typical value	Maximum value
Insertion loss	ANT-LOW	[25±5°C]	2300 to 2500MHz	(dB)	—	0.55	0.7
		[-40 to +85°C]	2300 to 2500MHz	(dB)	—	—	0.85
	ANT-HIGH	[25±5°C]	4900 to 5950MHz	(dB)	—	0.8	1.0
		[-40 to +85°C]	4900 to 5950MHz	(dB)	—	—	1.2
Attenuation	ANT-LOW		3950MHz	(dB)	18	24	—
			4600 to 5000MHz	(dB)	25	29	—
			5000 to 5950MHz	(dB)	25	29	—
			6500 to 7500MHz	(dB)	18	25	—
	ANT-HIGH		1300 to 1800MHz	(dB)	35	40	—
			1800 to 2000MHz	(dB)	37	42	—
			2100 to 2300MHz	(dB)	36	41	—
			2300 to 2500MHz	(dB)	30	38	—
			2500 to 3500MHz	(dB)	11	13.5	—
			3500 to 3950MHz	(dB)	4	7	—
			9800 to 10700MHz	(dB)	15	24	—
			10700 to 11700MHz	(dB)	10	22	—
Return loss	ANT		2300 to 2500MHz	(dB)	10	15	—
			4900 to 5950MHz	(dB)	9	13	—
	LOW		2300 to 2500MHz	(dB)	10	15	—
			4900 to 5950MHz	(dB)	9	13	—
Temperature range	Operating	(°C)	—	—	—	+85	
	Storage	(°C)	—	—	—	+85	

FREQUENCY CHARACTERISTICS

ANT-LOW

S11

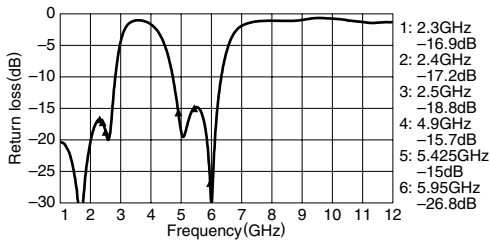

S21

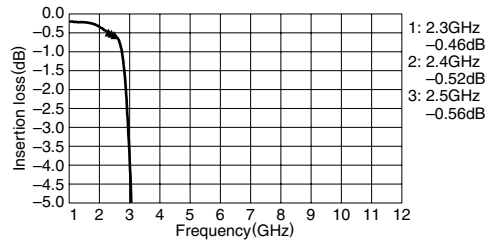

S21

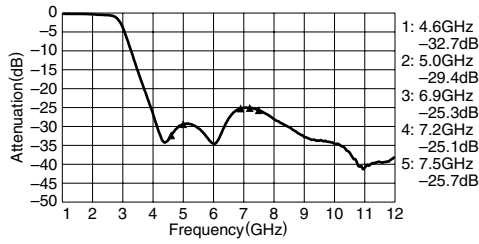

S22

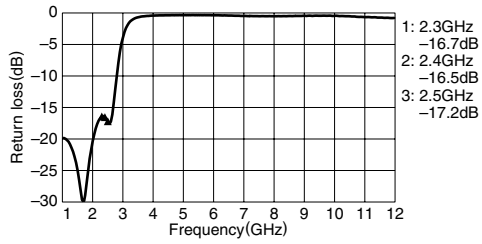

ANT-HIGH

S11

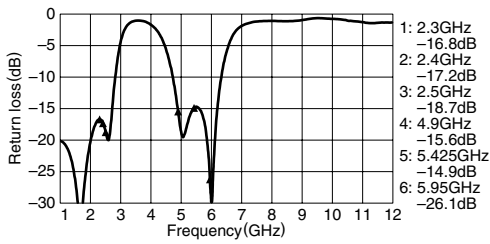

S21

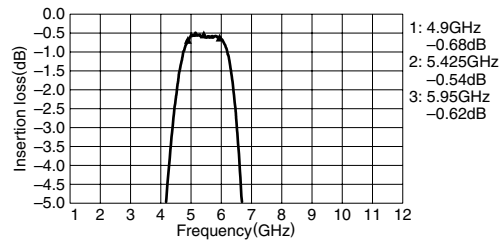

S21

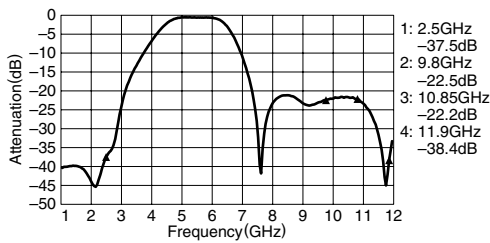

S22

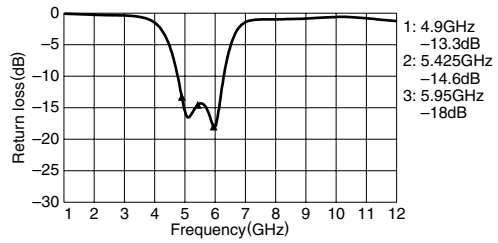

Multilayer Diplexers, DPX Series

DPX315950DT-5006C1 For 2.4/5GHz W-LAN

SHAPES AND DIMENSIONS

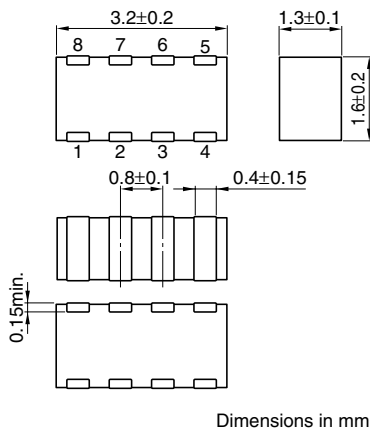

TERMINAL FUNCTIONS

1	LOW (2.4GHz)
2	GND
3	GND
4	HIGH (5.0GHz)
5	GND
6	GND
7	ANT (COMMON)
8	GND

RECOMMENDED PCB PATTERN

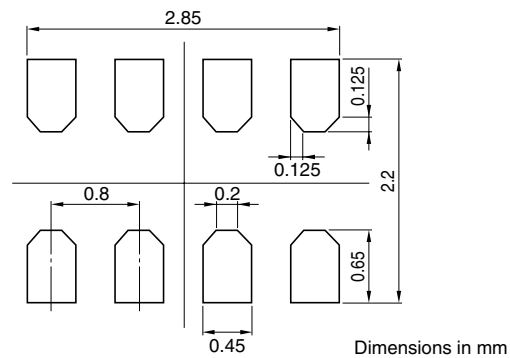

ELECTRICAL CHARACTERISTICS

Item	Port		Frequency range		Minimum value	Typical value	Maximum value
Insertion loss	ANT-LOW	[25±5°C]	2400 to 2500MHz	(dB)	—	1.0	1.5
	ANT-HIGH	[25±5°C]	5000 to 5950MHz	(dB)	—	0.8	1.2
Attenuation	ANT-LOW		DC to 1500MHz	(dB)	25	30	—
			4800 to 5950MHz	(dB)	21	25	—
			6500 to 7500MHz	(dB)	10	16	—
			DC to 1500MHz	(dB)	40	48	—
	ANT-HIGH		1500 to 2000MHz	(dB)	30	48	—
			2500 to 3850MHz	(dB)	21	26	—
			3850 to 3883MHz	(dB)	19.5	25	—
			6500MHz	(dB)	—	1.2	—
Return loss	ANT-HIGH		7200 to 7700MHz	(dB)	3	4.8	—
			9000 to 10000MHz	(dB)	13	16	—
			2400 to 2500MHz	(dB)	10	—	—
Temperature range			Operating	(°C)	-40	—	+85
			Storage	(°C)	-40	—	+85

FREQUENCY CHARACTERISTICS

ANT-LOW

S11

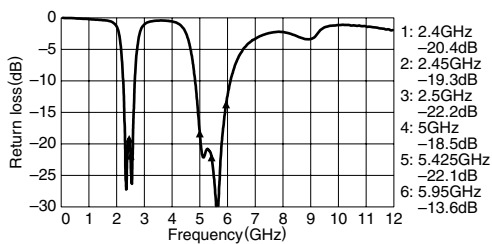

S21

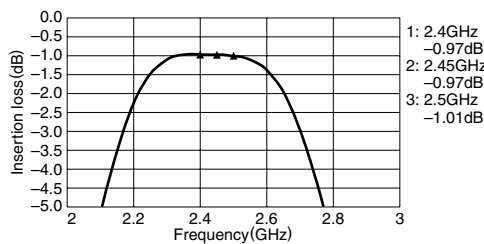

S21

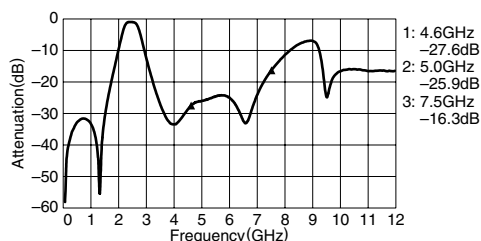

S22

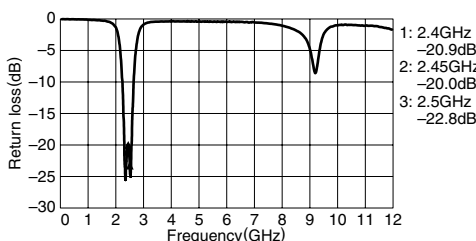

ANT-HIGH

S11

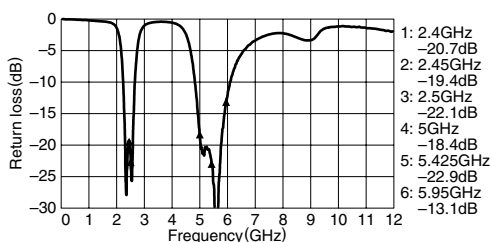

S21

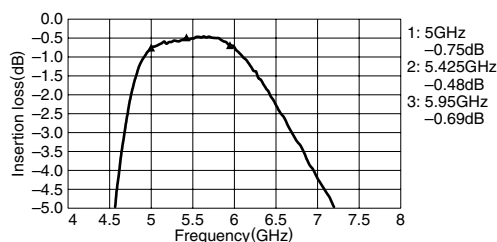

S21

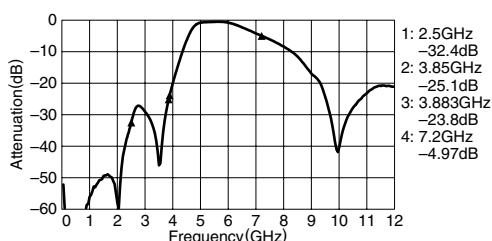

S22

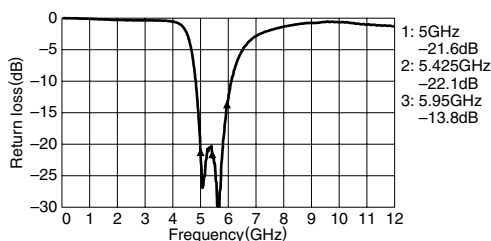

• All specifications are subject to change without notice.