

OVERVIEW

The WF5027 series are miniature crystal oscillator module ICs. The oscillator circuit stage has voltage regulator drive, significantly reducing current consumption and crystal current, compared with existing devices, and significantly reducing the oscillator characteristics supply voltage dependency. There are 3 pad layout package options available for optimized mounting, making these devices ideal for miniature crystal oscillators.

FEATURES

- Wide range of operating supply voltage: 1.60 to 3.63V
 - Regulated voltage drive oscillator circuit for reduced power consumption and crystal drive current
 - Optimized low crystal drive current oscillation for miniature crystal units
 - 3 pad layout options for mounting
 - 5027A×, M×, Q× series: for Flip Chip Bonding
 - 5027B×, N×, R× series: for Wire Bonding (type I)
 - 5027C×, P×, S× series: for Wire Bonding (type II)
 - Recommended oscillation frequency range
 - For fundamental oscillator**
 - Low frequency version: 20MHz to 60MHz
 - High frequency version: 60MHz to 100MHz
 - For 3rd overtone oscillator**
 - Low frequency version: 40MHz to 110MHz
 - High frequency version^{*1}: 110MHz to 180MHz
 - Multi-stage frequency divider for low-frequency output support: 0.9MHz (min)
 - Frequency divider built-in (for fundamental oscillator)
 - Selectable by version: f_O , $f_O/2$, $f_O/4$, $f_O/8$, $f_O/16$, $f_O/32$, $f_O/64$
 - -40 to 85°C operating temperature range
 - Standby function
 - High impedance in standby mode, oscillator stops
 - CMOS output duty level (1/2VDD)
 - 50 ± 5% output duty
 - 15pF output drive capability
 - Wafer form (WF5027××)
Chip form (CF5027××)
- *1: under development

APPLICATIONS

- 3.2 × 2.5, 2.5 × 2.0, 2.0 × 1.6 size miniature crystal oscillator modules

ORDERING INFORMATION

Device	Package
WF5027××-4	Wafer form
CF5027××-4	Chip form

SERIES CONFIGURATION

For Fundamental Oscillator

Operating supply voltage range [V]	Output drive capability [mA]	PAD layout	Recommended oscillation frequency range ^{*1} [MHz]	Version ^{*2}						
				f ₀ output	f ₀ /2 output	f ₀ /4 output	f ₀ /8 output	f ₀ /16 output	f ₀ /32 output	f ₀ /64 output
1.60 to 3.63	± 4	Flip Chip Bonding	20 to 60	5027A1	5027A2	5027A3	5027A4	5027A5	5027A6	5027A7
			60 to 100	5027AP	5027AQ	5027AR	5027AS	5027AT	5027AV	5027AW
		Wire Bonding Type I	20 to 60	5027B1	5027B2	5027B3	5027B4	5027B5	5027B6	5027B7
			60 to 100	5027BP	5027BQ	5027BR	5027BS	5027BT	5027BV	5027BW
		Wire Bonding Type II	20 to 60	5027C1	5027C2	5027C3	5027C4	5027C5	5027C6	5027C7
			60 to 100	5027CP	5027CQ	5027CR	5027CS	5027CT	5027CV	5027CW

*1. The recommended oscillation frequency is a yardstick value derived from the crystal used for NPC characteristics authentication. However, the oscillation frequency range is not guaranteed. Specifically, the characteristics can vary greatly due to crystal characteristics and mounting conditions, so the oscillation characteristics of components must be carefully evaluated.

*2. Wafer form devices have designation WF5027×× and chip form devices have designation CF5027××.

For 3rd Overtone Oscillator

Operating supply voltage range [V]	Output drive capability [mA]	PAD layout	Recommended oscillation frequency range ^{*1} [MHz] and version ^{*2}					
			40 to 50	50 to 65	65 to 85	85 to 110	110 to 145	145 to 180
1.60 to 3.63	± 8	Flip Chip Bonding	5027MA	5027MB	5027MC	5027MD	(5027QE)	(5027QF)
		Wire Bonding Type I	5027NA	5027NB	5027NC	5027ND	(5027RE)	(5027RF)
		Wire Bonding Type II	5027PA	5027PB	5027PC	5027PD	(5027SE)	(5027SF)

*1. The recommended oscillation frequency is a yardstick value derived from the crystal used for NPC characteristics authentication. However, the oscillation frequency range is not guaranteed. Specifically, the characteristics can vary greatly due to crystal characteristics and mounting conditions, so the oscillation characteristics of components must be carefully evaluated.

*2. Wafer form devices have designation WF5027×× and chip form devices have designation CF5027××.
Versions in parentheses () are under development.

VERSION NAME

Device	Package	Version name
WF5027××-4	Wafer form	<p style="text-align: center;">WF5027□□-4</p> <p>Form WF: Wafer form CF: Chip (Die) form</p> <p style="text-align: right;">Oscillation frequency range, frequency divider function</p> <p style="text-align: right;">Pad layout type A, M, Q: for Flip Chip Bonding B, N, R: for Wire Bonding (type I) C, P, S: for Wire Bonding (type II)</p>
CF5027××-4	Chip form	

PAD LAYOUT

(Unit: μm)

■ 5027A \times , M \times , Q \times
(for Flip Chip Bonding)

■ 5027B \times , N \times , R \times
(for Wire Bonding (type I))

■ 5027C \times , P \times , S \times
(for Wire Bonding (type II))

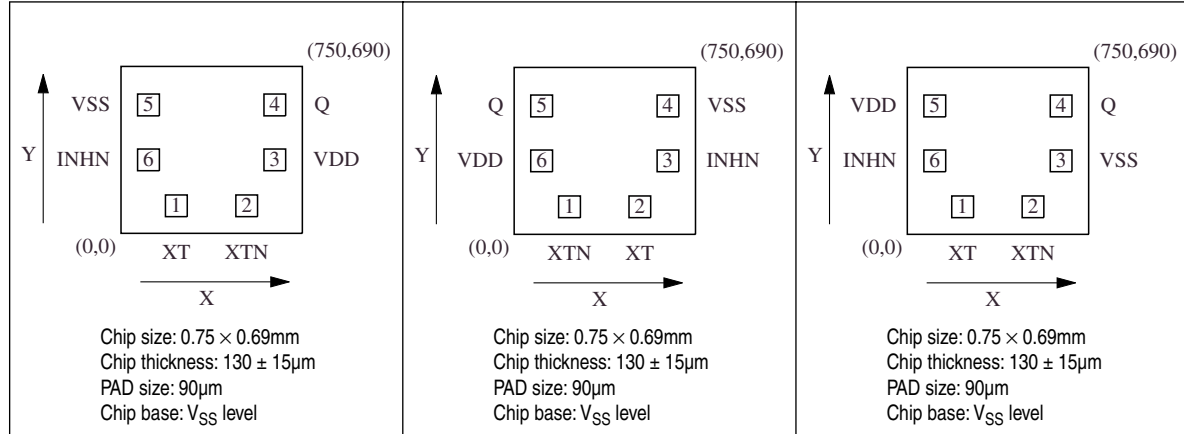

PAD DIMENSIONS PIN DESCRIPTION

Pad No.	Pad dimensions [μm]		Pad No.			Pin	Name	Description
	X	Y	5027A \times 5027M \times 5027Q \times	5027B \times 5027N \times 5027R \times	5027C \times 5027P \times 5027S \times			
1	229	114	1	2	1	XT	Amplifier input	Crystal connection pins. Crystal is connected between XT and XTN.
2	520	114	2	1	2	XTN	Amplifier output	
3	636	304	3	6	5	VDD	(+) supply voltage	-
4	636	531	4	5	4	Q	Output	Output frequency determined by internal circuit to one of f_0 , $f_0/2$, $f_0/4$, $f_0/8$, $f_0/16$, $f_0/32$, $f_0/64$
5	114	531	5	4	3	VSS	(-) ground	-
6	114	304	6	3	6	INHN	Output state control input	High impedance when LOW (oscillator stops). Power-saving pull-up resistor built-in.

BLOCK DIAGRAM

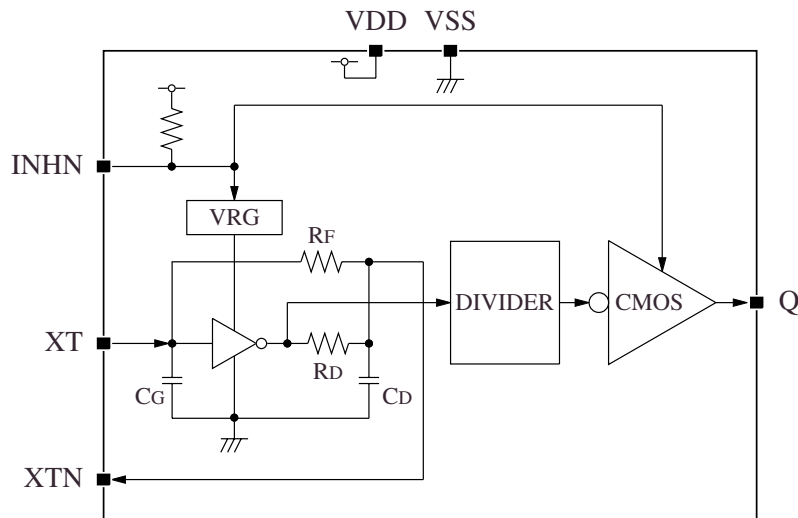

VERSION DISCRIMINATION INTERNAL COMPONENTS

The WF5027 series device version is not determined solely by the mask pattern, but can also be determined by the trimming of internal trimming fuses.

- Version determined by laser trimming:

These chips are produced from a common device by the laser trimming of fuses corresponding to the ordered version, shown in table 1. These devices are shipped for electrical characteristics testing. Laser-trimmed versions are identified externally by the combination of the version name marking (1) and the locations of trimmed fuses (2).

- Version determined by mask pattern:

These chips are fabricated using the mask corresponding to the ordered version, and do not require trimming. Mask-fabricated versions are identified externally by the version name marking (1) only.

Since the WF5027 series devices are manufactured using 2 methods, there are 2 types of IC chip available (identified externally) for the same version name. The identification markings for all WF5027 series device versions is shown in table 2.

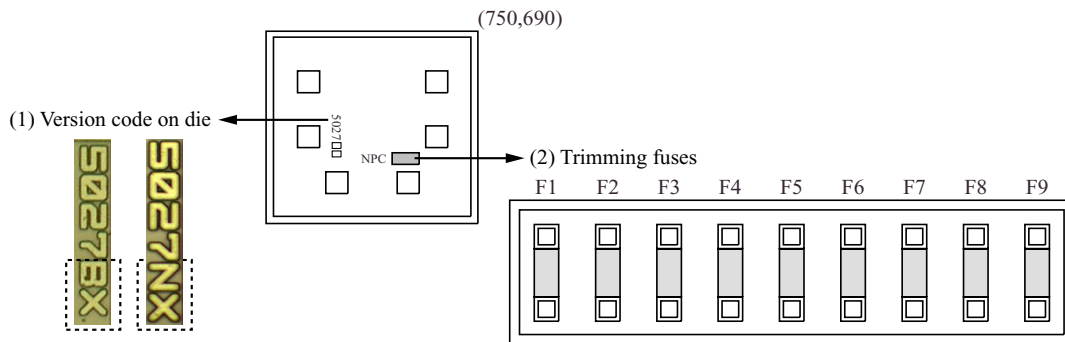
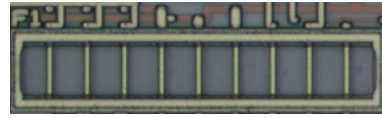

Table 1. Version and trimming fuses (for fundamental oscillator)

Version	Trimming fuse number ^{*1}				
	F1	F2	F3	F4	F5
5027×1	-	-	-	-	-
5027×2	×	-	-	-	-
5027×3	-	×	-	-	-
5027×4	×	×	-	-	-
5027×5	-	-	×	-	-
5027×6	×	-	×	-	-
5027×7	-	×	×	-	-
5027×P	-	-	-	×	×
5027×Q	×	-	-	×	×
5027×R	-	×	-	×	×
5027×S	×	×	-	×	×
5027×T	-	-	×	×	×
5027×V	×	-	×	×	×
5027×W	-	×	×	×	×

*1. -: untrimmed, ×: trimmed, F6 to F9 not used

- 5027×1 trimming fuses (untrimmed)



- 5027×2 trimming fuses (F1 link trimmed)

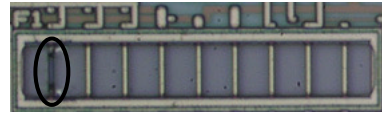

- 5027×3 trimming fuses (F2 link trimmed)

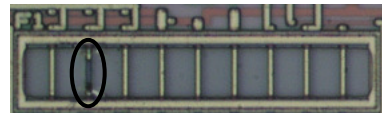

- 5027×4 trimming fuses (F1 and F2 links trimmed)

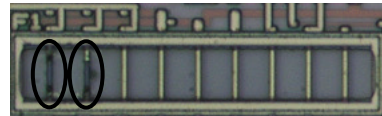

○ : trimmed device

Table 2. Version and trimming fuses (for 3rd overtone oscillator)

Version	Recommended oscillation frequency range ^{*1} [MHz]	Trimming fuse number ^{*2}								
		F1	F2	F3	F4	F5	F6	F7	F8	F9
5027×A	40 to 50	-	-	-	-	-	-	×	×	×
5027×B	50 to 65	-	×	-	-	-	-	-	×	×
5027×C	65 to 85	×	×	-	-	×	-	×	-	×
5027×D	85 to 110	-	×	×	×	×	-	×	-	×
5027×E	(110 to 145)	TBD								
5027×F	(145 to 180)									

*1. Values in parentheses () are provisional only.

*2. -: untrimmed, ×: trimmed

WF5027 series

Table 3. Version identification by version name and chip markings (for fundamental oscillator)

Version name	Version set by trimming fuses										Version set by mask pattern	
	Version code on chip	Trimming fuses*1									Version code on chip	Trimming fuses
		F1	F2	F3	F4	F5	F6	F7	F8	F9		F1 to F9
5027A1	AX	-	-	-	-	-					AX	Untrimmed
5027A2	AX	×	-	-	-	-					A2	
5027A3	AX	-	×	-	-	-					A3	
5027A4	AX	×	×	-	-	-					A4	
5027A5	AX	-	-	×	-	-					A5	
5027A6	AX	×	-	×	-	-					A6	
5027A7	AX	-	×	×	-	-					A7	
5027AP	AX	-	-	-	×	×					AP	
5027AQ	AX	×	-	-	×	×					AQ	
5027AR	AX	-	×	-	×	×					AR	
5027AS	AX	×	×	-	×	×					AS	
5027AT	AX	-	-	×	×	×					AT	
5027AV	AX	×	-	×	×	×					AV	
5027AW	AX	-	×	×	×	×					AW	
5027B1	BX	-	-	-	-	-					BX	
5027B2	BX	×	-	-	-	-					B2	
5027B3	BX	-	×	-	-	-					B3	
5027B4	BX	×	×	-	-	-					B4	
5027B5	BX	-	-	×	-	-					B5	
5027B6	BX	×	-	×	-	-					B6	
5027B7	BX	-	×	×	-	-					B7	
5027BP	BX	-	-	-	×	×			Untrimmed		BP	
5027BQ	BX	×	-	-	×	×					BQ	
5027BR	BX	-	×	-	×	×					BR	
5027BS	BX	×	×	-	×	×					BS	
5027BT	BX	-	-	×	×	×					BT	
5027BV	BX	×	-	×	×	×					BV	
5027BW	BX	-	×	×	×	×					BW	
5027C1	CX	-	-	-	-	-					CX	
5027C2	CX	×	-	-	-	-					C2	
5027C3	CX	-	×	-	-	-					C3	
5027C4	CX	×	×	-	-	-					C4	
5027C5	CX	-	-	×	-	-					C5	
5027C6	CX	×	-	×	-	-					C6	
5027C7	CX	-	×	×	-	-					C7	
5027CP	CX	-	-	-	×	×					CP	
5027CQ	CX	×	-	-	×	×					CQ	
5027CR	CX	-	×	-	×	×					CR	
5027CS	CX	×	×	-	×	×					CS	
5027CT	CX	-	-	×	×	×					CT	
5027CV	CX	×	-	×	×	×					CV	
5027CW	CX	-	×	×	×	×					CW	

*1. -: untrimmed, ×: trimmed

WF5027 series

Table 4. Version identification by version name and chip markings (for 3rd overtone oscillator)

Version name	Version set by trimming fuses										Version set by mask pattern	
	Version code on chip	Trimming fuses ^{*1}									Version code on chip	Trimming fuses
		F1	F2	F3	F4	F5	F6	F7	F8	F9		F1 to F9
5027MA	MX	–	–	–	–	–	–	×	×	×	MA	Untrimmed
5027MB	MX	–	×	–	–	–	–	–	×	×	MB	
5027MC	MX	×	×	–	–	×	–	×	–	×	MC	
5027MD	MX	–	×	×	×	×	–	×	–	×	MD	
5027NA	NX	–	–	–	–	–	–	×	×	×	NA	
5027NB	NX	–	×	–	–	–	–	–	×	×	NB	
5027NC	NX	×	×	–	–	×	–	×	–	×	NC	
5027ND	NX	–	×	×	×	×	–	×	–	×	ND	
5027PA	PX	–	–	–	–	–	–	×	×	×	PA	
5027PB	PX	–	×	–	–	–	–	–	×	×	PB	
5027PC	PX	×	×	–	–	×	–	×	–	×	PC	
5027PD	PX	–	×	×	×	×	–	×	–	×	PD	
(5027QE)	TBD											
(5027QF)												
(5027RE)												
(5027RF)												
(5027SE)												
(5027SF)												

*1. –: untrimmed, ×: trimmed

SPECIFICATIONS

Absolute Maximum Ratings

$$V_{SS} = 0V$$

Parameter	Symbol	Condition	Rating	Unit
Supply voltage range	V_{DD}	Between VDD and VSS	-0.5 to +4.0	V
Input voltage range	V_{IN}	Input pins	-0.5 to $V_{DD} + 0.5$	V
Output voltage range	V_{OUT}	Output pins	-0.5 to $V_{DD} + 0.5$	V
Storage temperature range	T_{STG}	Wafer form	-65 to +150	°C
Output current	I_{OUT}	Q pin	± 20	mA

Recommended Operating Conditions

For Fundamental Oscillator

$$V_{SS} = 0V$$

Parameter	Symbol	Condition	Rating			Unit	
			min	typ	max		
Operating supply voltage	V_{DD}	$CL \leq 15pF$	1.60	-	3.63	V	
Input voltage	V_{IN}	Input pins	V_{SS}	-	V_{DD}	V	
Operating temperature	T_{OPR}		-40	-	+85	°C	
Oscillation frequency*1	f_O	5027×1 to 5027×7	20	-	60	MHz	
		5027×P to 5027×W	60	-	100	MHz	
Output frequency	f_{OUT}	$CL \leq 15pF$	5027×1 to 5027×7	0.9	-	60	MHz
			5027×P to 5027×W	0.9	-	100	MHz

*1. The oscillation frequency is a yardstick value derived from the crystal used for NPC characteristics authentication. However, the oscillation frequency range is not guaranteed. Specifically, the characteristics can vary greatly due to crystal characteristics and mounting conditions, so the oscillation characteristics of components must be carefully evaluated.

For 3rd Overtone Oscillator

$$V_{SS} = 0V$$

Parameter	Symbol	Condition	Rating			Unit
			min	typ	max	
Operating supply voltage	V_{DD}	$CL \leq 15pF$	1.60	-	3.63	V
Input voltage	V_{IN}	Input pins	V_{SS}	-	V_{DD}	V
Operating temperature	T_{OPR}		-40	-	+85	°C
Oscillation frequency*1	f_O	5027×A	40	-	50	MHz
		5027×B	50	-	65	MHz
		5027×C	65	-	85	MHz
		5027×D	85	-	110	MHz

*1. The oscillation frequency is a yardstick value derived from the crystal used for NPC characteristics authentication. However, the oscillation frequency range is not guaranteed. Specifically, the characteristics can vary greatly due to crystal characteristics and mounting conditions, so the oscillation characteristics of components must be carefully evaluated.

Electrical Characteristics

DC Characteristics

For Fundamental Oscillator: Low frequency version (5027×1 to 5027×7)

$V_{DD} = 1.60$ to $3.63V$, $V_{SS} = 0V$, $T_a = -40$ to $+85^\circ C$ unless otherwise noted.

Parameter	Symbol	Condition	Rating			Unit		
			min	typ	max			
HIGH-level output voltage	V_{OH}	Q: Measurement cct 3, $I_{OH} = -4mA$	$V_{DD} - 0.4$	–	–	V		
LOW-level output voltage	V_{OL}	Q: Measurement cct 3, $I_{OL} = 4mA$	–	–	0.4	V		
HIGH-level input voltage	V_{IH}	INH, Measurement cct 4	$0.7V_{DD}$	–	–	V		
LOW-level input voltage	V_{IL}	INH, Measurement cct 4	–	–	$0.3V_{DD}$	V		
Output leakage current	I_Z	Q: Measurement cct 5, INH = LOW	$V_{OH} = V_{DD}$	–	–	10	μA	
			$V_{OL} = V_{SS}$	–10	–	–	μA	
Current consumption*1	I_{DD}	5027×1 (f_O), Measurement cct 1, no load, INH = open, $f_O = 48MHz$, $f_{OUT} = 48MHz$	$V_{DD} = 3.3V$	–	1.6	2.4	mA	
			$V_{DD} = 2.5V$	–	1.3	2.0	mA	
			$V_{DD} = 1.8V$	–	1.0	1.5	mA	
		5027×2 ($f_O/2$), Measurement cct 1, no load, INH = open, $f_O = 48MHz$, $f_{OUT} = 24MHz$	$V_{DD} = 3.3V$	–	1.5	2.3	mA	
			$V_{DD} = 2.5V$	–	1.2	1.8	mA	
			$V_{DD} = 1.8V$	–	0.9	1.4	mA	
		5027×3 ($f_O/4$), Measurement cct 1, no load, INH = open, $f_O = 48MHz$, $f_{OUT} = 12MHz$	$V_{DD} = 3.3V$	–	1.3	2.0	mA	
			$V_{DD} = 2.5V$	–	1.0	1.5	mA	
			$V_{DD} = 1.8V$	–	0.8	1.2	mA	
		5027×4 ($f_O/8$), Measurement cct 1, no load, INH = open, $f_O = 48MHz$, $f_{OUT} = 6MHz$	$V_{DD} = 3.3V$	–	1.1	1.7	mA	
			$V_{DD} = 2.5V$	–	0.9	1.4	mA	
			$V_{DD} = 1.8V$	–	0.75	1.15	mA	
		5027×5 ($f_O/16$), Measurement cct 1, no load, INH = open, $f_O = 48MHz$, $f_{OUT} = 3MHz$	$V_{DD} = 3.3V$	–	1.05	1.6	mA	
			$V_{DD} = 2.5V$	–	0.85	1.3	mA	
			$V_{DD} = 1.8V$	–	0.7	1.1	mA	
		5027×6 ($f_O/32$), Measurement cct 1, no load, INH = open, $f_O = 48MHz$, $f_{OUT} = 1.5MHz$	$V_{DD} = 3.3V$	–	1.0	1.5	mA	
			$V_{DD} = 2.5V$	–	0.85	1.3	mA	
			$V_{DD} = 1.8V$	–	0.7	1.1	mA	
		5027×7 ($f_O/64$), Measurement cct 1, no load, INH = open, $f_O = 60MHz$, $f_{OUT} = 0.94MHz$	$V_{DD} = 3.3V$	–	1.0	1.5	mA	
			$V_{DD} = 2.5V$	–	0.85	1.3	mA	
			$V_{DD} = 1.8V$	–	0.7	1.1	mA	
		Standby current	I_{ST}	Measurement cct 1, INH = LOW	–	–	10	μA
		INH pull-up resistance	R_{UP1}	Measurement cct 6	0.4	1.5	8	$M\Omega$
			R_{UP2}		30	70	150	$k\Omega$
Oscillator feedback resistance	R_f		50	100	200	$k\Omega$		
Oscillator capacitance	C_G	Design value (a monitor pattern on a wafer is tested), Excluding parasitic capacitance.	4.8	6	7.2	pF		
	C_D		8	10	12	pF		

*1. The consumption current $I_{DD}(C_L)$ with a load capacitance (C_L) connected to the Q pin is given by the following equation, where I_{DD} is the no-load consumption current and f_{OUT} is the output frequency.

$$I_{DD}(C_L) [mA] = I_{DD} [mA] + C_L [pF] \times V_{DD} [V] \times f_{OUT} [MHz] \times 10^{-3}$$

WF5027 series

For Fundamental Oscillator: High frequency version (5027×P to 5027×W)

$V_{DD} = 1.60$ to $3.63V$, $V_{SS} = 0V$, $T_a = -40$ to $+85^{\circ}C$ unless otherwise noted.

Parameter	Symbol	Condition	Rating			Unit		
			min	typ	max			
HIGH-level output voltage	V_{OH}	Q: Measurement cct 3, $I_{OH} = -4mA$	$V_{DD} - 0.4$	–	–	V		
LOW-level output voltage	V_{OL}	Q: Measurement cct 3, $I_{OL} = 4mA$	–	–	0.4	V		
HIGH-level input voltage	V_{IH}	INH, Measurement cct 4	$0.7V_{DD}$	–	–	V		
LOW-level input voltage	V_{IL}	INH, Measurement cct 4	–	–	$0.3V_{DD}$	V		
Output leakage current	I_Z	Q: Measurement cct 5, INH = LOW	$V_{OH} = V_{DD}$	–	–	10	μA	
			$V_{OL} = V_{SS}$	–10	–	–	μA	
Current consumption*1	I_{DD}	5027×P (f_O), Measurement cct 1, no load, INH = open, $f_O = 80MHz$, $f_{OUT} = 80MHz$	$V_{DD} = 3.3V$	–	2.5	3.8	mA	
			$V_{DD} = 2.5V$	–	2.0	3.0	mA	
			$V_{DD} = 1.8V$	–	1.6	2.4	mA	
		5027×Q ($f_O/2$), Measurement cct 1, no load, INH = open, $f_O = 80MHz$, $f_{OUT} = 40MHz$	$V_{DD} = 3.3V$	–	2.4	3.6	mA	
			$V_{DD} = 2.5V$	–	1.9	2.9	mA	
			$V_{DD} = 1.8V$	–	1.5	2.3	mA	
		5027×R ($f_O/4$), Measurement cct 1, no load, INH = open, $f_O = 80MHz$, $f_{OUT} = 20MHz$	$V_{DD} = 3.3V$	–	1.8	2.7	mA	
			$V_{DD} = 2.5V$	–	1.5	2.3	mA	
			$V_{DD} = 1.8V$	–	1.2	1.6	mA	
		5027×S ($f_O/8$), Measurement cct 1, no load, INH = open, $f_O = 80MHz$, $f_{OUT} = 10MHz$	$V_{DD} = 3.3V$	–	1.7	2.6	mA	
			$V_{DD} = 2.5V$	–	1.4	2.1	mA	
			$V_{DD} = 1.8V$	–	1.1	1.7	mA	
		5027×T ($f_O/16$), Measurement cct 1, no load, INH = open, $f_O = 80MHz$, $f_{OUT} = 5MHz$	$V_{DD} = 3.3V$	–	1.6	2.4	mA	
			$V_{DD} = 2.5V$	–	1.3	2.0	mA	
			$V_{DD} = 1.8V$	–	1.0	1.5	mA	
		5027×V ($f_O/32$), Measurement cct 1, no load, INH = open, $f_O = 80MHz$, $f_{OUT} = 2.5MHz$	$V_{DD} = 3.3V$	–	1.5	2.3	mA	
			$V_{DD} = 2.5V$	–	1.2	1.8	mA	
			$V_{DD} = 1.8V$	–	1.0	1.5	mA	
		5027×W ($f_O/64$), Measurement cct 1, no load, INH = open, $f_O = 80MHz$, $f_{OUT} = 1.25MHz$	$V_{DD} = 3.3V$	–	1.5	2.3	mA	
			$V_{DD} = 2.5V$	–	1.2	1.8	mA	
			$V_{DD} = 1.8V$	–	1.0	1.5	mA	
		Standby current	I_{ST}	Measurement cct 1, INH = LOW	–	–	10	μA
		INH pull-up resistance	R_{UP1}	Measurement cct 6	0.4	1.5	8	$M\Omega$
			R_{UP2}		30	70	150	$k\Omega$
Oscillator feedback resistance	R_f		50	100	200	$k\Omega$		
Oscillator capacitance	C_G	Design value (a monitor pattern on a wafer is tested), Excluding parasitic capacitance.	1.6	2	2.4	pF		
	C_D		3.2	4	4.8	pF		

*1. The consumption current $I_{DD}(C_L)$ with a load capacitance (C_L) connected to the Q pin is given by the following equation, where I_{DD} is the no-load consumption current and f_{OUT} is the output frequency.

$$I_{DD}(C_L) [mA] = I_{DD} [mA] + C_L [pF] \times V_{DD} [V] \times f_{OUT} [MHz] \times 10^{-3}$$

WF5027 series

For 3rd Overtone Oscillator (5027×A to 5027×D)

$V_{DD} = 1.60$ to 3.63 V, $V_{SS} = 0$ V, $T_a = -40$ to $+85$ °C unless otherwise noted.

Parameter	Symbol	Condition	Rating			Unit	
			min	typ	max		
HIGH-level output voltage	V_{OH}	Q: Measurement cct 3, $I_{OH} = -8$ mA, $V_{DD} = 2.25$ to 3.63 V	$V_{DD} - 0.4$	–	–	V	
		Q: Measurement cct 3, $I_{OH} = -4$ mA, $V_{DD} = 1.60$ to 2.25 V	$V_{DD} - 0.4$	–	–	V	
LOW-level output voltage	V_{OL}	Q: Measurement cct 3, $I_{OL} = 8$ mA, $V_{DD} = 2.25$ to 3.63 V	–	–	0.4	V	
		Q: Measurement cct 3, $I_{OL} = 4$ mA, $V_{DD} = 1.60$ to 2.25 V	–	–	0.4	V	
HIGH-level input voltage	V_{IH}	INH, Measurement cct 4	$0.7V_{DD}$	–	–	V	
LOW-level input voltage	V_{IL}	INH, Measurement cct 4	–	–	$0.3V_{DD}$	V	
Output leakage current	I_Z	Q: Measurement cct 5, INHN = LOW	$V_{OH} = V_{DD}$	–	–	10	μA
			$V_{OL} = V_{SS}$	–10	–	–	μA
Current consumption*1	I_{DD}	5027×A, Measurement cct 1, no load, INHN = open, $f_O = 48$ MHz	$V_{DD} = 3.3$ V	–	3.6	5.4	mA
			$V_{DD} = 2.5$ V	–	3.0	4.5	mA
			$V_{DD} = 1.8$ V	–	2.6	3.9	mA
		5027×B, Measurement cct 1, no load, INHN = open, $f_O = 54$ MHz	$V_{DD} = 3.3$ V	–	3.8	5.7	mA
			$V_{DD} = 2.5$ V	–	3.2	4.8	mA
			$V_{DD} = 1.8$ V	–	2.8	4.2	mA
		5027×C, Measurement cct 1, no load, INHN = open, $f_O = 85$ MHz	$V_{DD} = 3.3$ V	–	4.8	7.2	mA
			$V_{DD} = 2.5$ V	–	4.0	6.0	mA
			$V_{DD} = 1.8$ V	–	3.4	5.1	mA
		5027×D, Measurement cct 1, no load, INHN = open, $f_O = 100$ MHz	$V_{DD} = 3.3$ V	–	5.3	8.0	mA
			$V_{DD} = 2.5$ V	–	4.4	6.6	mA
			$V_{DD} = 1.8$ V	–	3.6	5.4	mA
Standby current	I_{ST}	Measurement cct 1, INHN = LOW	–	–	10	μA	
INH pull-up resistance	R_{UP1}	Measurement cct 6	0.4	1.5	8	MΩ	
	R_{UP2}		30	70	150	kΩ	
Oscillator feedback resistance	R_f	5027×A	2.6	3.8	5.0	kΩ	
		5027×B	2.2	3.2	4.2	kΩ	
		5027×C	1.9	2.8	3.7	kΩ	
		5027×D	1.9	2.8	3.7	kΩ	
Oscillator capacitance	C_G	Design value (a monitor pattern on a wafer is tested), Excluding parasitic capacitance.	5027×A	9.6	12	14.4	pF
			5027×B	6.4	8	9.6	pF
			5027×C	4.8	6	7.2	pF
			5027×D	1.6	2	2.4	pF
	C_D	Design value (a monitor pattern on a wafer is tested), Excluding parasitic capacitance.	5027×A	9.6	12	14.4	pF
			5027×B	9.6	12	14.4	pF
			5027×C	6.4	8	9.6	pF
			5027×D	4.8	6	7.2	pF

*1. The consumption current $I_{DD}(C_L)$ with a load capacitance (C_L) connected to the Q pin is given by the following equation, where I_{DD} is the no-load consumption current and f_{OUT} is the output frequency.

$$I_{DD}(C_L) [\text{mA}] = I_{DD} [\text{mA}] + C_L [\text{pF}] \times V_{DD} [\text{V}] \times f_{OUT} [\text{MHz}] \times 10^{-3}$$

AC Characteristics

For Fundamental Oscillator (5027×1 to 5027×7, 5027×P to 5027×W)

$V_{DD} = 1.60$ to $3.63V$, $V_{SS} = 0V$, $T_a = -40$ to $+85^\circ C$ unless otherwise noted.

Parameter	Symbol	Condition	Rating			Unit	
			min	typ	max		
Output rise time	t_{r1}	Measurement cct 1, $C_L = 15pF$, $0.1V_{DD}$ to $0.9V_{DD}$	$V_{DD} = 2.25$ to $3.36V$	–	2.0	4.5	ns
	t_{r2}		$V_{DD} = 1.60$ to $2.25V$	–	3.0	5.0	ns
Output fall time	t_{f1}	Measurement cct 1, $C_L = 15pF$, $0.9V_{DD}$ to $0.1V_{DD}$	$V_{DD} = 2.25$ to $3.36V$	–	2.0	4.5	ns
	t_{f2}		$V_{DD} = 1.60$ to $2.25V$	–	3.0	5.0	ns
Output duty cycle	Duty	Measurement cct 1, $T_a = 25^\circ C$, $C_L = 15pF$	45	50	55	%	
Output disable delay time	t_{OD}	Measurement cct 2, $T_a = 25^\circ C$, $C_L \leq 15pF$	–	–	50	μs	

For 3rd Overtone Oscillator (5027×A to 5027×D)

$V_{DD} = 1.60$ to $3.63V$, $V_{SS} = 0V$, $T_a = -40$ to $+85^\circ C$ unless otherwise noted.

Parameter	Symbol	Condition	Rating			Unit	
			min	typ	max		
Output rise time	t_{r1}	Measurement cct 1, $C_L = 15pF$, $0.1V_{DD}$ to $0.9V_{DD}$	$V_{DD} = 2.25$ to $3.36V$	–	1.2	3.0	ns
	t_{r2}		$V_{DD} = 1.60$ to $2.25V$	–	1.6	4.0	ns
Output fall time	t_{f1}	Measurement cct 1, $C_L = 15pF$, $0.9V_{DD}$ to $0.1V_{DD}$	$V_{DD} = 2.25$ to $3.36V$	–	1.2	3.0	ns
	t_{f2}		$V_{DD} = 1.60$ to $2.25V$	–	1.6	4.0	ns
Output duty cycle	Duty	Measurement cct 1, $T_a = 25^\circ C$, $C_L = 15pF$	45	50	55	%	
Output disable delay time	t_{OD}	Measurement cct 2, $T_a = 25^\circ C$, $C_L \leq 15pF$	–	–	50	μs	

Timing chart

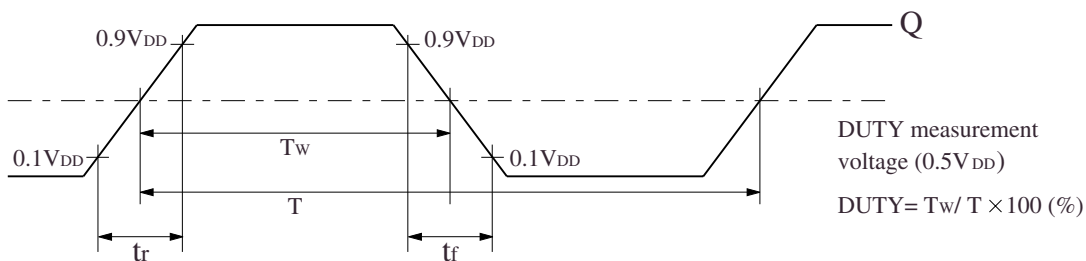
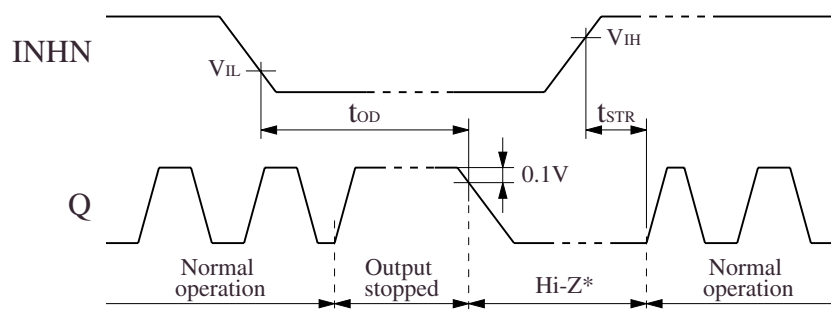

Figure 1. Output switching waveform



When INHN goes HIGH to LOW, the Q output goes HIGH once and then becomes high impedance.

When INHN goes LOW to HIGH, the Q output goes from high impedance to normal output operation when the oscillation starts (oscillation is detected).

*) The high-impedance interval in the figure is shown as a LOW level due to the $1k\Omega$ pull-down resistor connected to the Q pin (see "Measurement circuit 2" in the "Measurement Circuits" section).

Figure 2. Output disable and oscillation start timing chart

FUNCTIONAL DESCRIPTION

Standby Function

When INHN goes LOW, the Q output becomes high impedance.

INHN	Q	Oscillator
HIGH (or open)	Frequency output	Normal operation
LOW	High impedance	Stopped

Power-saving Pull-up Resistor

The INHN pin pull-up resistance R_{UP1} or R_{UP2} changes in response to the input level (HIGH or LOW). When INHN is tied LOW level, the pull-up resistance is large (R_{UP1}), reducing the current consumed by the resistance. When INHN is left open circuit, the pull-up resistance is small (R_{UP2}), which increases the input susceptibility to external noise. However, the pull-up resistance ties the INHN pin HIGH level to prevent external noise from unexpectedly stopping the output.

Oscillation Detector Function

The WF5027 series also feature an oscillation detector circuit. This circuit functions to disable the outputs until the oscillator circuit starts and oscillation becomes stable. This alleviates the danger of abnormal oscillator output at oscillator start-up when power is applied or when INHN is switched.

MEASUREMENT CIRCUITS

Measurement cct 1

Measurement parameter: I_{DD} , I_{ST} , Duty, t_r , t_f

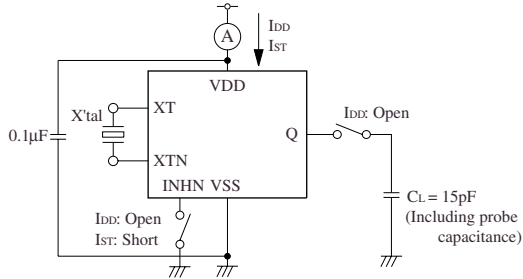

Note: The AC characteristics are observed using an oscilloscope on pin Q.

Measurement cct 4

Measurement parameter: V_{IH} , V_{IL}

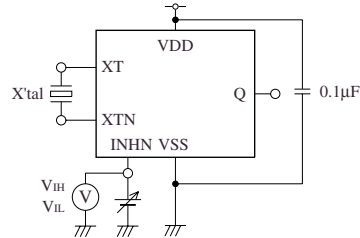

V_{IH} : Voltage in V_{SS} to V_{DD} transition that changes the output state.
 V_{IL} : Voltage in V_{DD} to V_{SS} transition that changes the output state.
 INHN has an oscillation stop function.

Measurement cct 2

Measurement parameter: t_{OD}

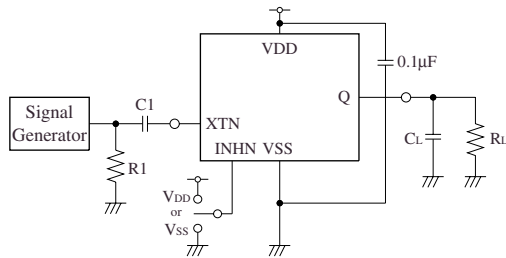

XTN input signal: 1Vp-p, sine wave
 $C1: 0.001\mu F$ $C_L: 15pF$
 $R1: 50\Omega$ $R_L: 1k\Omega$

Measurement cct 5

Measurement parameter: I_Z

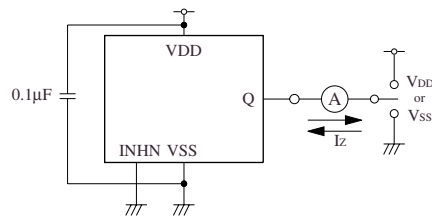

Measurement cct 6

Measurement parameter: R_{UP1} , R_{UP2}

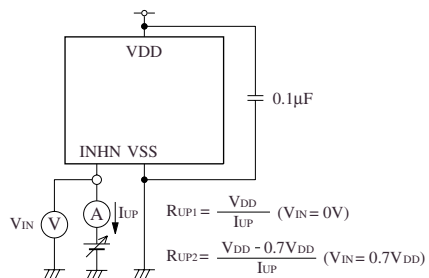

Measurement cct 3

Measurement parameter: V_{OH} , V_{OL}

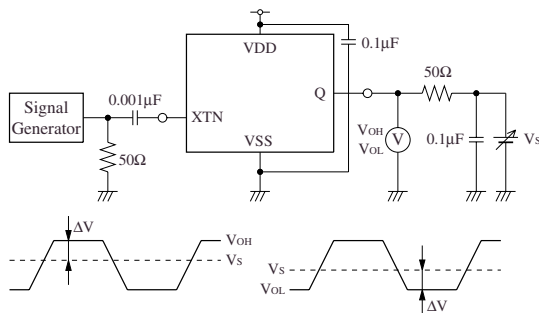

V_S adjusted such that $\Delta V = 50 \times I_{OH}$. V_S adjusted such that $\Delta V = 50 \times I_{OL}$.

XTN input signal: 1Vp-p, sine wave

TYPICAL PERFORMANCE (for fundamental oscillator)

The following characteristics measured using the crystal below. Note that the characteristics will vary with the crystal used.

■ Crystal used for measurement

Parameter	$f_0 = 48\text{MHz}$	$f_0 = 80\text{MHz}$
C_0 [pF]	1.6	2.1
R_1 [Ω]	12	10

■ Crystal parameters

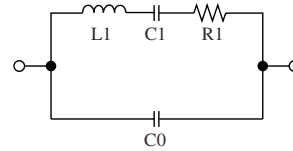

Current Consumption

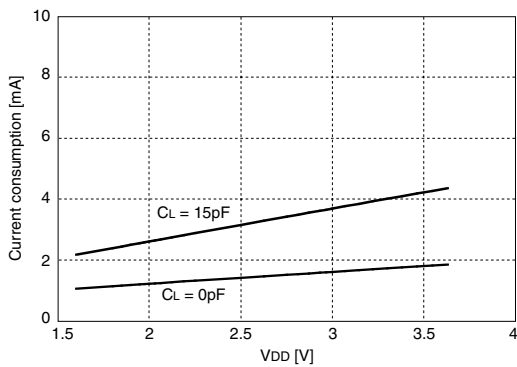

5027A1, $f_{OUT} = 48\text{MHz}$, $T_a = 25^\circ\text{C}$

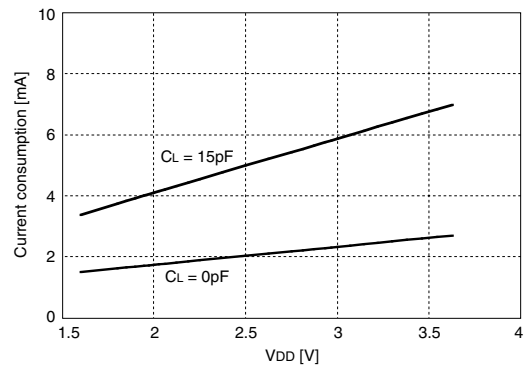

5027AP, $f_{OUT} = 80\text{MHz}$, $T_a = 25^\circ\text{C}$

Negative Resistance

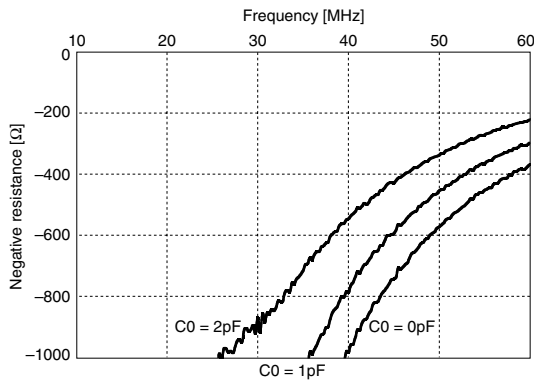

5027x1 to x7, $V_{DD} = 3.3\text{V}$, $T_a = 25^\circ\text{C}$

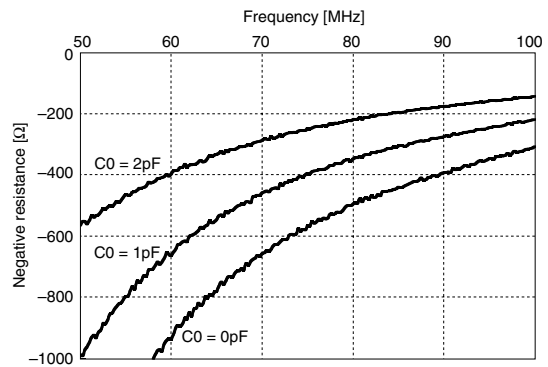

5027xP to xW, $V_{DD} = 3.3\text{V}$, $T_a = 25^\circ\text{C}$

Characteristics are measured with a capacitance C_0 , representing the crystal equivalent circuit C_0 capacitance, connected between the XT and XTN pins. Measurements are performed with Agilent 4396B using the NPC test jig. Characteristics may vary with measurement jig and measurement conditions.

Frequency Deviation by Supply Voltage Change

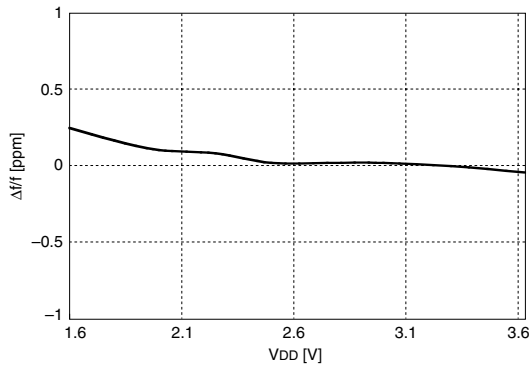

5027×1 to ×7, $f_{OUT} = 48\text{MHz}$,
3.3V standard, $T_a = 25^\circ\text{C}$

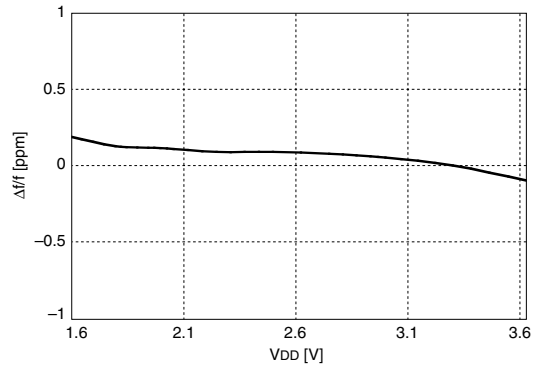

5027×P to ×W, $f_{OUT} = 80\text{MHz}$,
3.3V standard, $T_a = 25^\circ\text{C}$

Drive Level

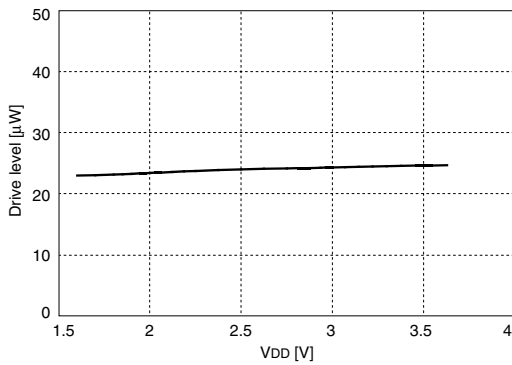

5027×1 to ×7, $f_{OUT} = 48\text{MHz}$, $T_a = 25^\circ\text{C}$

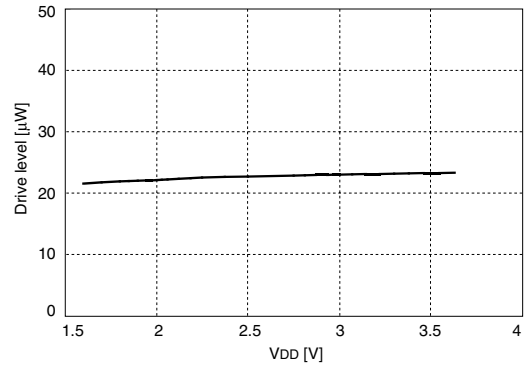

5027×P to ×W, $f_{OUT} = 80\text{MHz}$, $T_a = 25^\circ\text{C}$

Phase Noise

Measurement equipment: Agilent E5052 Signal Source Analyzer

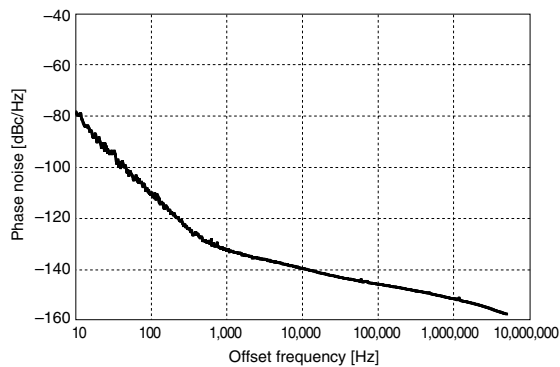

5027A1, $V_{DD} = 3.3\text{V}$, $f_{OSC} = f_{OUT} = 48\text{MHz}$,
 $T_a = 25^\circ\text{C}$

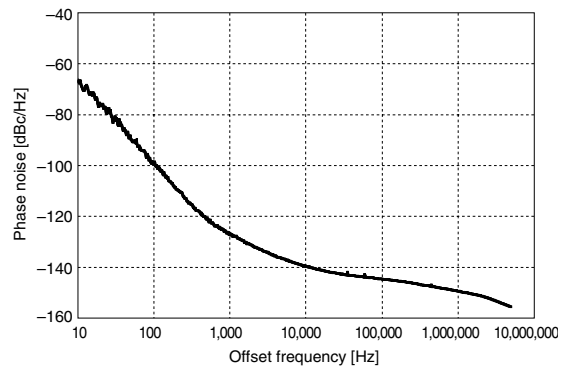

5027AP, $V_{DD} = 3.3\text{V}$, $f_{OSC} = f_{OUT} = 80\text{MHz}$,
 $T_a = 25^\circ\text{C}$

Output Waveform

Measurement equipment: Agilent 54855A Oscilloscope

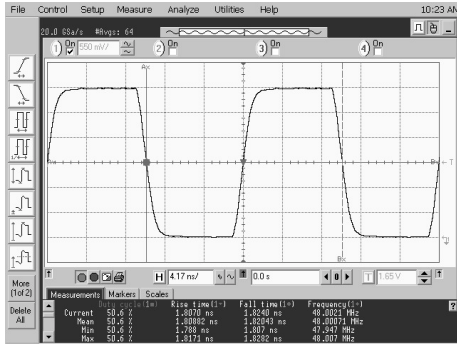

5027A1, $V_{DD} = 3.3V$, $f_{OUT} = 48MHz$,
 $C_L = 15pF$, $T_a = 25^\circ C$

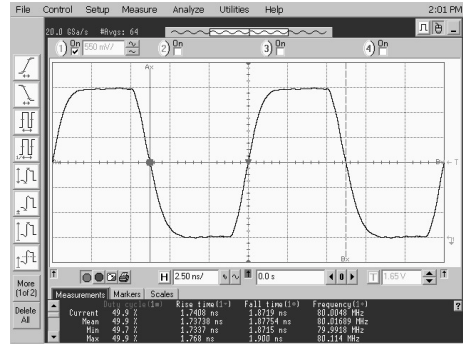

5027AP, $V_{DD} = 3.3V$, $f_{OUT} = 80MHz$,
 $C_L = 15pF$, $T_a = 25^\circ C$

TYPICAL PERFORMANCE (for 3rd overtone oscillator)

The following characteristics measured using the crystal below. Note that the characteristics will vary with the crystal used.

■ Crystal used for measurement

Parameter	$f_0 = 85\text{MHz}$	$f_0 = 100\text{MHz}$
C0 [pF]	0.9	1.2
R1 [Ω]	56	45

■ Crystal parameters

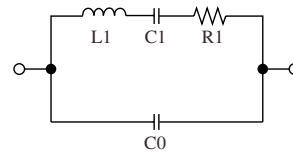

Current Consumption

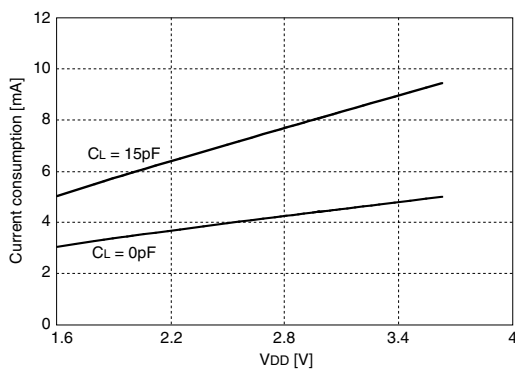

5027xD, $f_{OUT} = 85\text{MHz}$, $T_a = 25^\circ\text{C}$

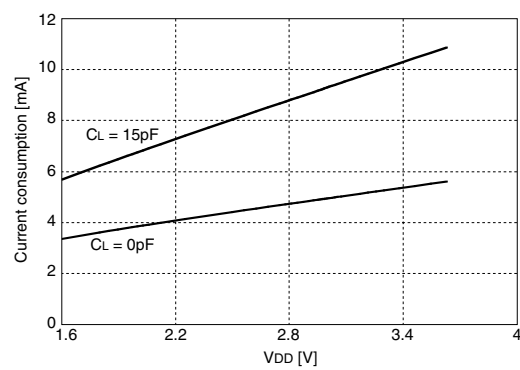

5027AP, $f_{OUT} = 100\text{MHz}$, $T_a = 25^\circ\text{C}$

Negative Resistance

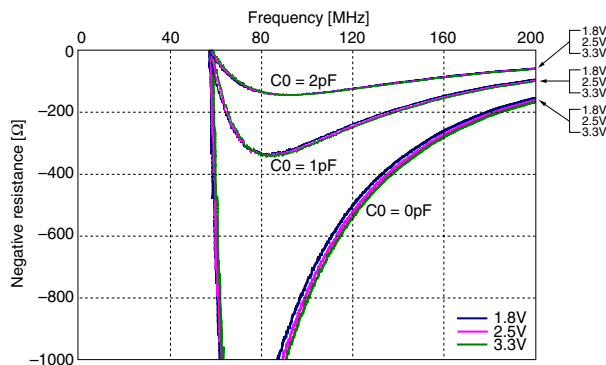

5027xD, $T_a = 25^\circ\text{C}$, recommended operating frequency range: 85MHz to 110MHz

Characteristics are measured with a capacitance C0, representing the crystal equivalent circuit C0 capacitance, connected between the XT and XTN pins. Measurements are performed with Agilent 4396B using the NPC test jig. Characteristics may vary with measurement jig and measurement conditions.

Frequency Deviation by Supply Voltage Change

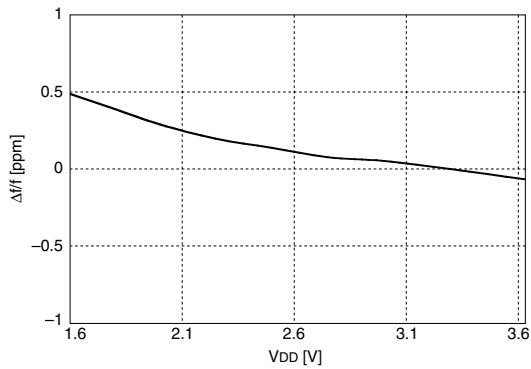

5027×D, $f_{OUT} = 85\text{MHz}$, 3.3V standard, $T_a = 25^\circ\text{C}$

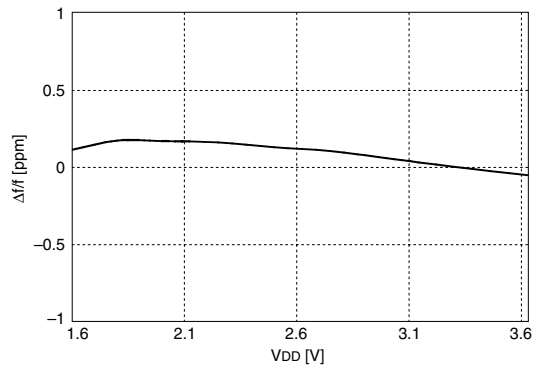

5027×D, $f_{OUT} = 100\text{MHz}$, 3.3V standard, $T_a = 25^\circ\text{C}$

Drive Level

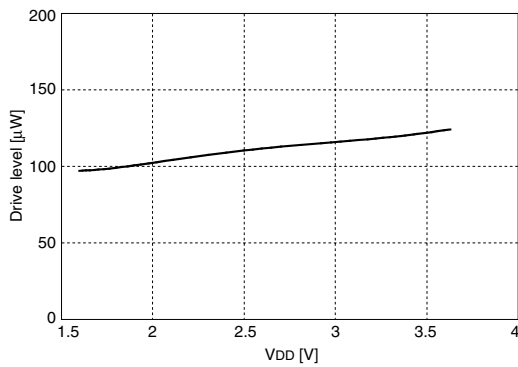

5027×D, $f_{OUT} = 85\text{MHz}$, $T_a = 25^\circ\text{C}$

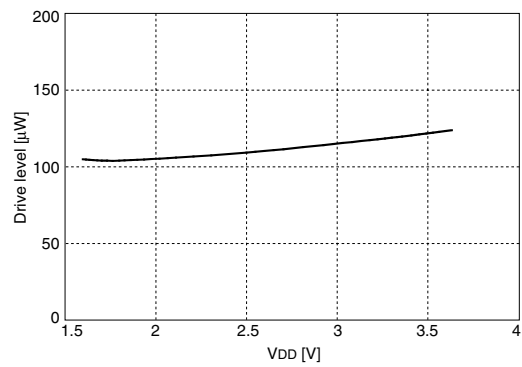

5027×D, $f_{OUT} = 100\text{MHz}$, $T_a = 25^\circ\text{C}$

Phase Noise

Measurement equipment: Agilent E5052 Signal Source Analyzer

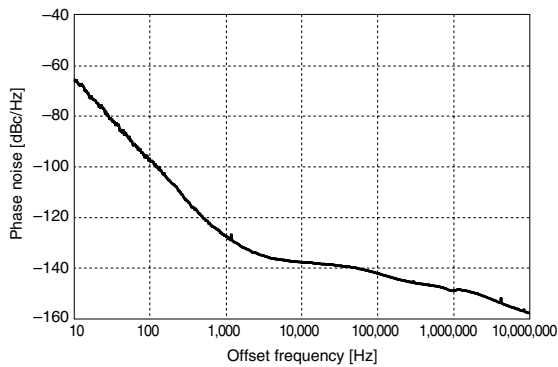

5027×D, $V_{DD} = 3.3\text{V}$, $f_{OSC} = f_{OUT} = 85\text{MHz}$, $T_a = 25^\circ\text{C}$

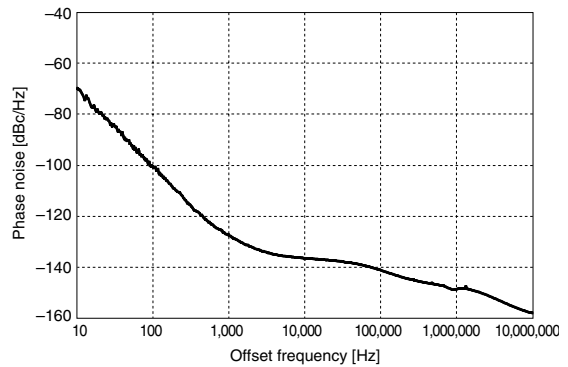

5027×D, $V_{DD} = 3.3\text{V}$, $f_{OSC} = f_{OUT} = 100\text{MHz}$, $T_a = 25^\circ\text{C}$

Output Waveform

Measurement equipment: Agilent 54855A Oscilloscope

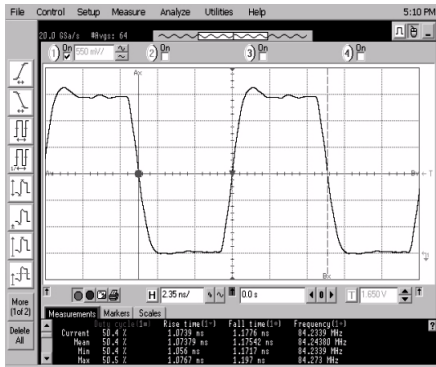

5027 \times D, $V_{DD} = 3.3V$, $f_{OUT} = 85MHz$,
 $C_L = 15pF$, $T_a = 25^\circ C$

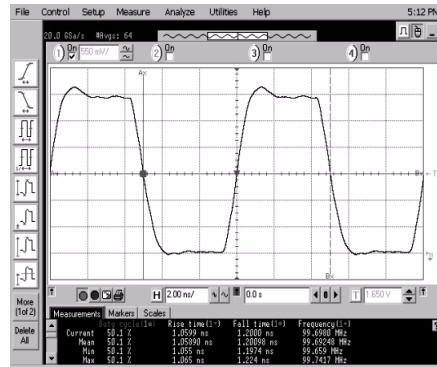

5027 \times D, $V_{DD} = 3.3V$, $f_{OUT} = 100MHz$,
 $C_L = 15pF$, $T_a = 25^\circ C$

Please pay your attention to the following points at time of using the products shown in this document.

The products shown in this document (hereinafter "Products") are not intended to be used for the apparatus that exerts harmful influence on human lives due to the defects, failure or malfunction of the Products. Customers are requested to obtain prior written agreement for such use from SEIKO NPC CORPORATION (hereinafter "NPC"). Customers shall be solely responsible for, and indemnify and hold NPC free and harmless from, any and all claims, damages, losses, expenses or lawsuits, due to such use without such agreement. NPC reserves the right to change the specifications of the Products in order to improve the characteristic or reliability thereof. NPC makes no claim or warranty that the contents described in this document dose not infringe any intellectual property right or other similar right owned by third parties. Therefore, NPC shall not be responsible for such problems, even if the use is in accordance with the descriptions provided in this document. Any descriptions including applications, circuits, and the parameters of the Products in this document are for reference to use the Products, and shall not be guaranteed free from defect, inapplicability to the design for the mass-production products without further testing or modification. Customers are requested not to export or re-export, directly or indirectly, the Products to any country or any entity not in compliance with or in violation of the national export administration laws, treaties, orders and regulations. Customers are requested appropriately take steps to obtain required permissions or approvals from appropriate government agencies.

The logo for SEIKO NPC CORPORATION, consisting of the letters 'NPC' in a bold, black, sans-serif font.

SEIKO NPC CORPORATION

15-6, Nihombashi-kabutocho, Chuo-ku,
Tokyo 103-0026, Japan
Telephone: +81-3-6667-6601
Facsimile: +81-3-6667-6611
<http://www.npc.co.jp/>
Email: sales@npc.co.jp

NC0505CE 2007.03