

Digital Fiber Optic & Laser Optic Sensor Guide



E32 Series Fiber Units

Amplifier Units



E3X-DAC-S True Color Series



E3X-DA-S/-MDA Series



E3X-NA/-SD Series

- »Offering unsurpassed sensing solutions
- »General purpose, standard detection requirements
- »Special beam, non-standard requirements
- »Application specific requirements

CONTENTS

Fiber Unit Overview

Standard Models	Flexible (New Standard).....	3
	Standard	4
	Break-resistant.....	4
	Fluorine Coated	5
Environmental Resistive Models	Heat-resistant.....	6
	Chemical-resistant	6
	Vacuum-resistant	7
Application-specific Models	Liquid-level Detection.....	8
Ordering Information	Through-beam Fiber Units	9
	Reflective Fiber Units	14
	Accessories.....	17
Ratings/Characteristics	21
Dimensions	Through-beam Fiber Units	22
	Reflective Fiber Units	25
	Application-specific Fiber Units	27
	Accessories.....	29
Precautions	31

Amplifier Overview

Ratings/Characteristics	E3X-SD Simple Fiber Optic Amplifiers with Digital Display.....	34
	E3X-NA Simple Fiber Optic Amplifiers with Bar Graph Display	34
	E3X-DA-S Dual Display Fiber Optic Amplifiers	36
	E3X-MDA Two-channel Dual Display Digital Fiber Optic Amplifiers	38
	E3X-DAC-S True Color Fiber Optic Amplifiers with Digital Dual Display	40
Accessories	42
Dimensions	46

Fiber Unit

Standard Models

Solutions for General-Purpose Applications

These Fibers Units can be used in a variety of applications, such as detecting the presence of workpieces and positioning.

A Wide Variety of Shapes for Adapting to Different Installation Locations

Choose the model that suits the installation space from a wide variety of shapes and sizes (7 shapes, in standard or small sizes).



Space Savings and Simple Mounting

Flat Models

Flat models that allow simple screw mounting and straightforward wiring have been added to the lineup. Using these models eliminates the problem of fibers getting caught on surrounding objects.

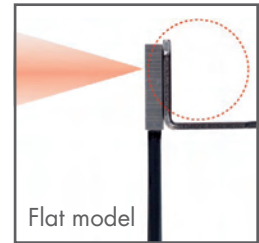

Detect Workpieces in Tight Spaces

Custom-produced Sleeves

Models with sleeves allow detection in tight spaces. We will perform the time-consuming task of fashioning the sleeve, with a length and bends to suit the space (except for ultrafine sleeves).

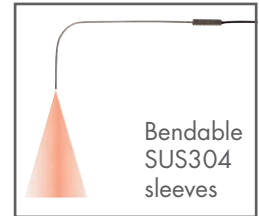

Flexible, Pliable Fiber That Can Be Handled Like Wire

We have developed a broad range of fibers to meet a wide variety of needs. Multicore (flexible) fiber is a new type of standard fiber that can be used like wire without worrying about the bending radius. We have also produced fiber that will not break when used in moving parts and fiber that is not degraded by contact with oil.

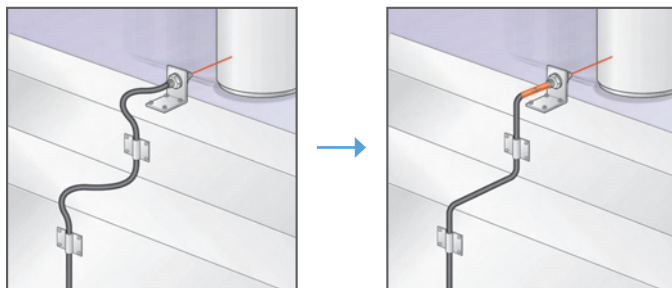

Conventional fiber

Flexible fiber

You will certainly appreciate the ease of use that flexible fiber ensures.

Cut to Length in the Field

Omron's fibers marked with this symbol  let you customize the length and eliminate excess fiber for a tidy, safe installation.

Length Can Be Specified in 1-m Units

Saving Energy and Work

We will produce fiber of the required length (in meter units). For large-scale installations, specifications of up to 20 m can be handled. (Specifications of 0.3 m and 0.5 m are also possible.)



Special-beam Models

Detection with Increased Reliability

A variety of heads incorporating the latest optical technology makes it possible to solve common problems related to detection and to increase reliability.

- Resistant to dust and dirt
- Capable of detecting small workpieces
- Resistant to workpiece vibration

Use these models to handle unstable detection conditions.



Small-spot models
E32-C42+
E39-F3A



Area-sensing models
E32-T16J



Limited-reflective models
E32-L24L



Area-sensing models
E32-T16J

Environment-resistive Models

High Resistance to External Conditions with Fiber

We have developed model variations for adapting to a variety of environmental conditions. These models enable detection in high-temperature environments and vacuums.

- High-temperature environments
- Environments subject to the splattering of chemicals
- Vacuums

Use these models to handle applications in special environments.



Heat-resistant models



Chemical-resistant models

Application-specific Models

Fiber Units for the Food-packaging, Semiconductor, and Solar Industries

These models, which were developed for specific applications, offer top-quality detection performance.

- Label detection
- Liquid-level detection
- Alignment and mapping of glass substrates
- Wafer mapping
- True color detection
- Distance measurement

Use these models for specific applications.



Label-detection models
E32-G14



Alignment-check models
E32-L16



Liquid-level detection models
E32-D36T

Standard Models

Flexible (New Standard)

R : Flexible fiber

- Perform wiring without worrying about the bending radius.
- Choose the model to suit the installation space from a variety of shapes.

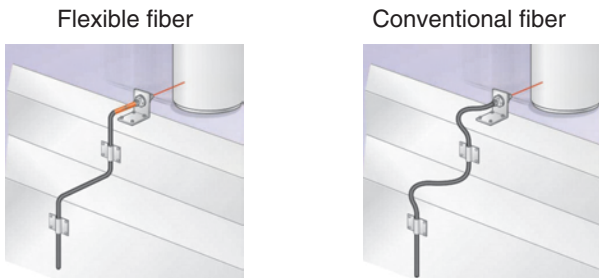

Fewer problems ◀ Light intensity affected by bends in fiber
Fiber broken by getting caught on surrounding objects

■ Feature: Multicore (Flexible) Fibers



A large number of ultrafine cores are all surrounded by cladding. As a result, the fiber is flexible and can be bent without significantly reducing the light intensity. This helps solve problems, such as fiber being broken by getting caught on other objects.

■ Ratings/Characteristics

Min. sensing object	0.005-mm dia.
Min. bending radius	1 mm
Ambient temperature	-40°C to 70°C (no icing or condensation)
Fiber material	Plastic Free-cut

Standard

- Choose the model to suit the installation space from a variety of shapes.
- New flat models allow space savings and simple installation.

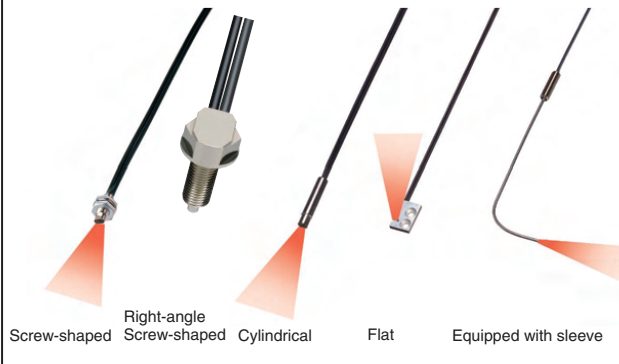

■ Feature: Flat Models

Flat models, which allow simple attachment and wiring, have been added to the lineup. Choose the model to suit the installation space from 3 sensing directions and 2 sizes, standard and small.



■ Ratings/Characteristics

Min. sensing object	0.005-mm dia.
Min. bending radius	10 or 25 mm*
Ambient temperature	-40°C to 70°C (no icing or condensation)
Fiber material	Plastic Free-cut

* Depends on the fiber diameter.

Break-resistant

B : Bendable fiber

- Bundle-fiber models can be used for moving parts.
- Capable of withstanding at least one million repeated bends (in typical applications).



■ Feature: Bundle Fibers

The Fiber Units contain a large number of independent fine fibers, ensuring a high degree of flexibility.

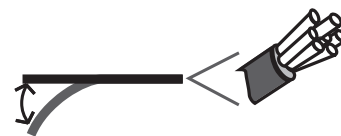

■ Ratings/Characteristics

Min. sensing object	0.005-mm dia.
Min. bending radius	4 mm (withstands repeated bending)
Ambient temperature	-40°C to 70°C (no icing or condensation)
Fiber material	Plastic Free-cut

Standard Models

Fluorine Coating

U: Fluorine-coated fiber

- Fiber degradation due to oil is prevented using a fluororesin coating.
- Free cutting is possible with cutter provided.

Oil is blocked!

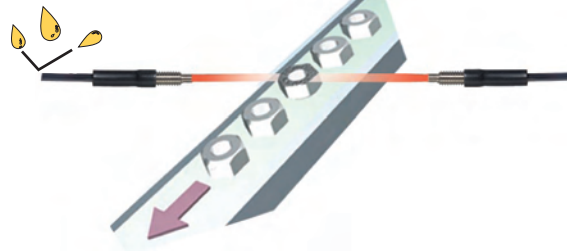

Feature: Fluorine Coating

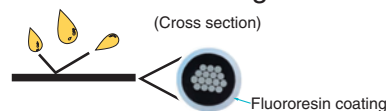

Fluororesin is used as the sheath material to prevent fiber degradation resulting from oil adhesion.

Note: The tip of the head is not chemical-resistant.

Ratings/Characteristics

Min. sensing object	0.005-mm dia.
Min. bending radius	4 mm
Ambient temperature	-40°C to 70°C (no icing or condensation)
Fiber material	Plastic Free-cut

Fiber Customization Service

(Fiber Length, Sleeve Length, and Bends)

Fiber Length

- Applicable Models
Standard models
- Model Number Used for Ordering
Standard model number + Fiber length
Fiber length: 0.3 m, 0.5 m, or any length from 1 to 20 m (in 1-m units)



Sleeve Length and Bends

This customization/delivery service applies to standard models. It is aimed at reducing industrial waste and simplifying the installation procedure.

Model Number Used When Changing the Sleeve Length and Bends

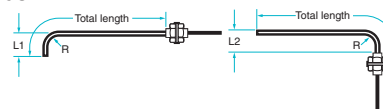

Model Numbers Incorporating the Bending Radius, R, and Dimensions L1 and L2

Fiber Length vs. Sensing Distance

Through-beam Fiber Units
E32-TC200B/E32-TC200F
(Fiber length of 2 m corresponds to 100%.)

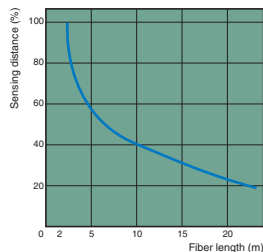

Fiber Units with Reflective Sensors
E32-DC200B/E32-DC200F
(Fiber length of 2 m corresponds to 100%.)

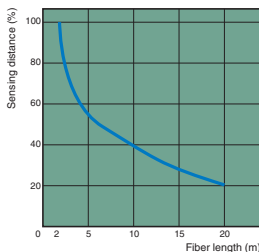

Model Number Used When Changing Only the Sleeve Length

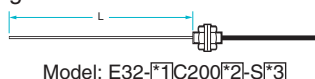

*1: Insert "T" for Through-beam Fiber Units and "D" for Fiber Units with Reflective Sensors.
*2: Insert the "B" or "F" that appears at the end of the original model number.
*3: Insert "50" if the total length is 50 mm. The total length must not exceed 120 mm.

Specifying L1 Only

Bending Radius	L1 (±1)	Model number
R5	10	E32- ^{*1} C200 ^{*2} -S ^{*3} A1
	15	E32- ^{*1} C200 ^{*2} -S ^{*3} A2
R7.5	12.5	E32- ^{*1} C200 ^{*2} -S ^{*3} B1
	17.5	E32- ^{*1} C200 ^{*2} -S ^{*3} B2
R10	15	E32- ^{*1} C200 ^{*2} -S ^{*3} C1
	20	E32- ^{*1} C200 ^{*2} -S ^{*3} C2
R12.5	17.5	E32- ^{*1} C200 ^{*2} -S ^{*3} D1
	22.5	E32- ^{*1} C200 ^{*2} -S ^{*3} D2

Specifying L2 Only

Bending Radius	L2 (±1)	Model number
R5	5	E32- ^{*1} C200 ^{*2} -S ^{*3} A3
	10	E32- ^{*1} C200 ^{*2} -S ^{*3} A4
R7.5	7.5	E32- ^{*1} C200 ^{*2} -S ^{*3} B3
	17.5	E32- ^{*1} C200 ^{*2} -S ^{*3} B4
R10	10	E32- ^{*1} C200 ^{*2} -S ^{*3} C3
	20	E32- ^{*1} C200 ^{*2} -S ^{*3} C4
R12.5	12.5	E32- ^{*1} C200 ^{*2} -S ^{*3} D3
	22.5	E32- ^{*1} C200 ^{*2} -S ^{*3} D4

Environment-resistive Models

Heat-resistant

- These Fiber Units can be used for various applications in temperatures up to 400°C.

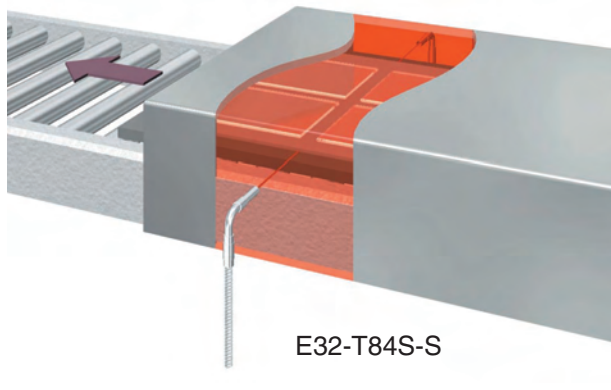

Applications

Detecting wafers in high-temperature environments

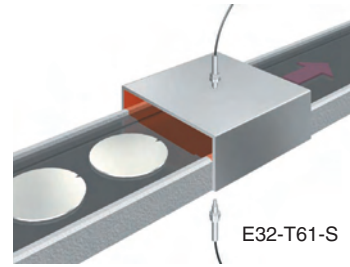

Ratings/Characteristics

	150°C models	200°C and higher models	
		E32-T81R E32-D81R	All other models
Min. bending radius	35 mm	10 mm	25 mm
Fiber material	Plastic (fluororesin coating) Free-cut	Glass (fluororesin coating)	Glass (SUS spiral coating)

Overview of Model Variations

Type	Ambient Temperature	Features	Shape, sensing distance (mm)*	Model number
Through-beam	-40°C to 150°C	M4 screw	760	E32-T51
	-40°C to 200°C	L-shaped, long distance	1,300	E32-T84S-S
	-60°C to 350°C	M4 screw	450	E32-T61-S
Reflective	-60°C to 350°C	M6 screw	90	E32-D61-S
	-40°C to 400°C	M6 screw, with sleeve	60	E32-D73-S

Chemical-resistant

- Built-in lens and high-power beam reduce the influence of dirt and drops of water.
- Round design prevents drops of water sticking to the head (E32-T11F).

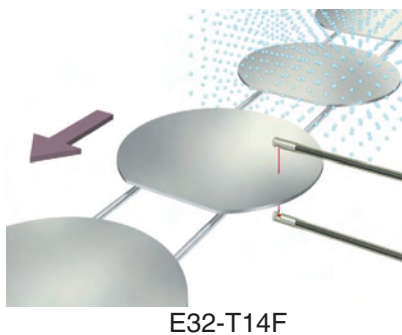

Applications

Detecting workpieces in cleaning processes

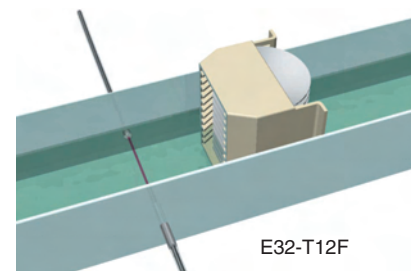

Ratings/Characteristics

	All other models	E32-T51F	E32-T81F-S
		Ambient temperature	-40°C to 70°C
Fiber material	Plastic (fluororesin coating) Free-cut	Glass (fluororesin coating)	

Overview of Model Variations

Type	Features	Shape, sensing distance (mm)*	Model number
Through-beam	Water-resistant round head	2,000	E32-T11F
	Built-in lens, high power	3,000	E32-T12F
	Heat-resistant up to 200°C	700	E32-T81F-S
Reflective	Built-in lens, high power	95	E32-D12F

*The sensing distances apply for use in combination with the E3X-DA-S Amplifier Unit (general-purpose, standard mode).

Environment-resistive Models

Vacuum-resistant

- These models can be used in high-vacuum environments at pressures from 10^{-5} to 0.1 Pa.
- The 4-channel multi-flange, which has a maximum leakage rate of 1×10^{-10} Pa·m³/s, contributes to space savings.



Applications (Configuration Example)

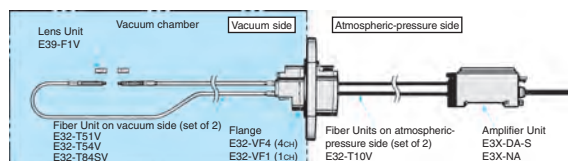

Ratings/Characteristics

	120°C models	200°C models	Atmospheric-pressure side
Min. bending radius	30 mm	25 mm	
Fiber material	Glass (fluororesin coating)	Glass (SUS spiral coating)	Plastic (fluororesin coating) Free-cut

Overview of Model Variations

Type	Features	Shape, sensing distance (mm)*	Model number
Through-beam	M4 screw, top-view, heat-resistant up to 120°C, long distance	1,000	E32-T51V 1M+ E39-F1V
	L-shaped, heat-resistant up to 120°C	130	E32-T54V 1M
	L-shaped, long distance, heat-resistant up to 200°C	480	E32-T84SV 1M

Fiber Units on Atmospheric-pressure Side

Appearance	Type	Model number
	Common	E32-T10V 2M

Flanges

Appearance	Type	Model number
	4-channel flange	E32-VF4
	1-channel flange	E32-VF1

Ratings/Characteristics

Number of channels		4 channels	1 channel
Item	Model number	E32-VF4	E32-VF1
Leakage rate	1×10 ⁻¹⁰ Pa·m ³ /s max.		
Ambient temperature	Operating: -25°C to 55°C Storage: -25°C to 55°C		
Material	Aluminum (A5056)		Stainless steel (SUS304) Aluminum (A5056)
Flange-seal material	Fluorocarbon rubber (Viton)		
Weight (packed state)	Approx. 280 g		Approx. 240 g

*The sensing distances apply for use in combination with the E3X-DA-S Amplifier Unit (general-purpose, standard mode).

Application-specific Models

Label Detection

- Built-in lens and high-power beam enable the reliable detection of labels through a mounting board.
- These Fiber Units can be washed with hydrogen peroxide, making them ideal for the food industry.



Applications

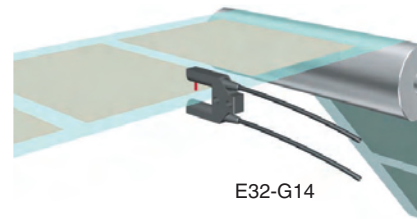

Detecting labels



Ratings/Characteristics

Ambient temperature	-40°C to 70°C (no icing or condensation)
Fiber material	Plastic Free-cut
Degree of protection	IP67

Overview of Model Variations

Type	Features	Shape, sensing distance (mm)*	Model number
Through-beam	Slot sensor, no adjustment of optical axis required	 10	E32-G14
	Screw mounting, side-view	 3,400	E32-T14

Liquid-level Detection

- Area sensing is possible with minimal influence from bubbles and drops of water (E32-A01/A02/D36T).
- For safety when disconnections occur, two models have been developed, a light ON model for liquid presence and a light ON model for liquid absence (E32-A01/ A02).

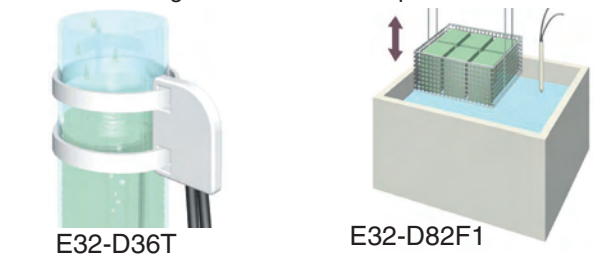

Operating Principle

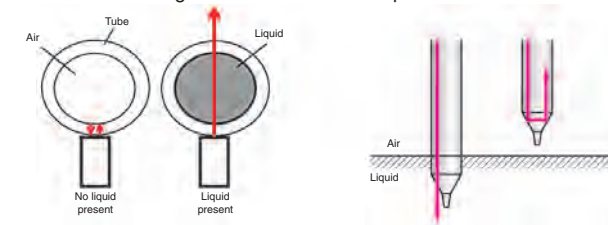

The presence/absence of liquid is detected using the refractive properties of light. More specifically, it utilizes the fact that the difference in refractive index between the air and the tip/tube is larger than the difference between the liquid and the tip/tube.

Overview of Model Variations

Type	Features	Shape, sensing distance (mm)*	Model number
Through-beam	Light ON when liquid is present (ideal for checking lower limits)	Applicable tube: Transparent tube with a diameter of 3.2, 6.4, or 9.5 mm and a recommended wall thickness of 1 mm	E32-A01
	Light ON when liquid is absent (ideal for checking for overflow)	Applicable tube: Transparent tube with a diameter in the range 6 to 13 mm and a recommended wall thickness of 1 mm	E32-A02
	No restriction on tube diameter, resistant to bubbles and drops of water	Applicable tube: Transparent tube (no restriction on diameter)	E32-D36T
Liquid-contact	Heat-resistant up to 200°C, shape prevents liquid buildup	Liquid-contact model	E32-D82F1

*The sensing distances apply for use in combination with the E3X-DA-S Amplifier Unit (general-purpose, standard mode).

Through-beam Fiber Units







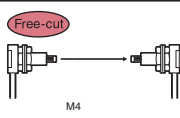
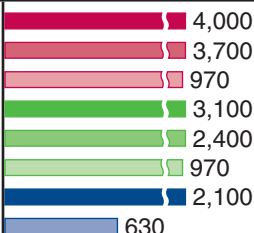

*1. The values for the minimum sensing object are representative values that indicate values obtained in standard mode with the sensing distance and sensitivity set to optimum values.

*2.  Indicates models that allow free cutting.

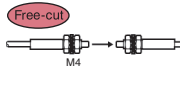
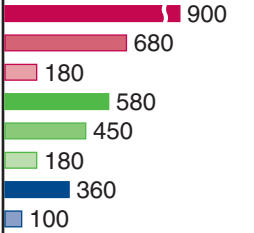
 High-resolution mode  Standard mode  Super-high-speed mode. When used in combination with the E3X-DA-S Amplifier Unit (general-purpose).

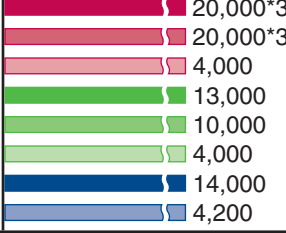
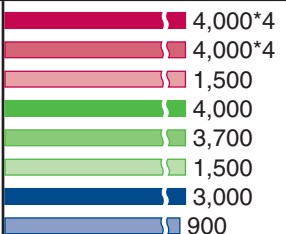
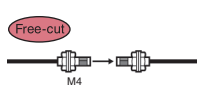
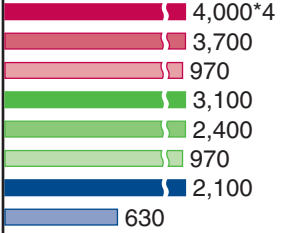

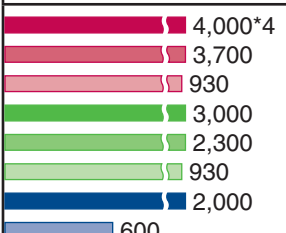
 High-resolution mode  Standard mode  Super-high-speed mode. When used in combination with the E3X-MDA Unit.

 When used in combination with E3X-NA-F high speed unit.  When used in combination with E3X-NA or E3X-SD standard units.

Type	Appearance (mm) *2	Sensing distance (mm)	Standard object (min. sensing object) (mm) *1	Min. bending radius (mm)	Features	Model number
Standard models	Standard Right angle 	 4,000 3,700 970 3,100 2,400 970 2,100 630	4 dia (0.005 dia.)	 R1	M4 screw, right angle, long distance	E32-T11N+ E39-F1 <i>NEW</i>
	Chemical resistant Standard size 	 900 680 180 580 450 180 360 100	1 dia (0.005 dia.)	 R4	M4 screw, fluorine coating	E32-T11U
Special-beam models	Long-distance, high-power 	 20,000*3 20,000*3 4,000 13,000 10,000 4,000 14,000 4,200	10 dia.	R25	Large built-in lens, M14 screw	E32-T17L
		 4,000*4 4,000*4 1,500 4,000 3,700 1,500 3,000 900			M4 screw	E32-TC200+ E39-F1
	Long-distance, high-power 	 4,000*4 3,700 970 3,100 2,400 970 2,100 630	4 dia. (0.1 dia.)	 R1	M4 screw, flexible fiber	E32-T11R+ E39-F1
		 4,000*4 3,700 930 3,000 2,300 930 2,000 600		 R4	M4 screw, break-resistant	E32-T11+ E39-F1

*3. The optical fiber is 10 m long on each side permitting a sensing distance of 20,000 mm.

*4. The optical fiber is 2 m long on each side permitting a sensing distance of 4,000 mm.

 : Flexible fiber  : Bendable fiber  : Fluorine-coated fiber

Through-beam Fiber Units

*1. The values for the minimum sensing object are representative values that indicate values obtained in standard mode with the sensing distance and sensitivity set to optimum values.

*2. **Free-cut** Indicates models that allow free cutting.

High-resolution mode Standard mode Super-high-speed mode. When used in combination with the E3X-DA-S Amplifier Unit (general-purpose).

High-resolution mode Standard mode Super-high-speed mode. When used in combination with the E3X-MDA Unit.

When used in combination with E3X-NA-F high speed unit. When used in combination with E3X-NA or E3X-SD standard units.

Type	Appearance (mm) *2	Sensing distance (mm)	Standard object (min. sensing object) (mm) *1	Min. bending radius (mm)	Features	Model number	
Special-beam models Area-sensing			(5 dia.) *4		Area width: 50 mm	E32-ET16WR-2 NEW	
					Area width: 70 mm	E32-ET16WR-1 NEW	
			(0.6 dia.) *4	R25	Area width: 10 mm; long distance	E32-T16	
			2 dia. (0.1 dia.)		Multi-point detection (4-head)	E32-M21	
Environment-resistive models Heat-resistant	150°C*5			1.5 dia. (0.1 dia.)	R35	Heat-resistant up to 150°C	E32-T51
						Heat-resistant up to 150°C; side-view	E32-T54

*4. This is the value for which detection is possible within the sensing area, with the sensing distance set to give a digital value of 1,000. (The sensing object is stationary.)

*5. For continuous operation, use the products within a temperature range of -40°C to 130°C.



: Flexible fiber : Bendable fiber : Fluorine-coated fiber

Ordering Information

Through-beam Fiber Units







*1. The values for the minimum sensing object are representative values that indicate values obtained in standard mode with the sensing distance and sensitivity set to optimum values.

*2.  Indicates models that allow free cutting.

 High-resolution mode  Standard mode  Super-high-speed mode. When used in combination with the E3X-DA-S Amplifier Unit (general-purpose).

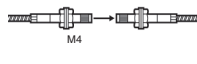
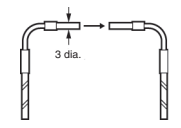

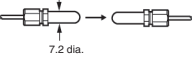
 High-resolution mode  Standard mode  Super-high-speed mode. When used in combination with the E3X-MDA Unit.

 When used in combination with E3X-NA-F high speed unit.  When used in combination with E3X-NA or E3X-SD standard units.

Type	Appearance (mm) *2	Sensing distance (mm)	Standard object (min. sensing object) (mm) *1	Min. bending radius (mm)	Features	Model number	
Environment-resistant models	Heat-resistant	200°C	 360 280 70 230 180 70 180 50	1 dia. (0.005 dia.)	R10	Heat-resistant up to 200°C *3	E32-T81R-S
			 600 450 120 230 180 70 180 50	3 dia. (0.1 dia.)	R25	Heat-resistant up to 200°C *3; side-view	E32-T61-S+ E39-F2
			 4,000*4 3,400 900 3,000 2,200 900 3,000 900	4 dia. (0.1 dia.)		Heat-resistant up to 200°C *3, long distance	E32-T61-S+ E39-F1
			 1,750 1,300 350 1,100 870 350 700 210	1.7 dia. (0.1 dia.)	Heat-resistant up to 200°C *3; L-shaped; long distance	E32-T84S-S	
	350°C	 600 450 120 390 300 120 900 90	1 dia. (0.005 dia.)	Heat-resistant up to 350°C *3	E32-T61-S		
Chemical-resistant	  7.2 dia.	2,500 2,000 520 1,600 1,300 520 1,050 380	4 dia. (0.1 dia.)	 R4	Fluororesin cover, round head	E32-T11F	

*3. The maximum temperature that can be withstood varies with the location. Refer to dimensions diagrams for details.

*4. The optical fiber is 2 m long on each side permitting a sensing distance of 4,000 mm.

 : Flexible fiber  : Bendable fiber  : Fluorine-coated fiber

Through-beam Fiber Units

*1. The values for the minimum sensing object are representative values that indicate values obtained in standard mode with the sensing distance and sensitivity set to optimum values.

*2. **Free-cut** Indicates models that allow free cutting.

High-resolution mode Standard mode Super-high-speed mode. When used in combination with the E3X-DA-S Amplifier Unit (general-purpose).

High-resolution mode Standard mode Super-high-speed mode. When used in combination with the E3X-MDA Unit.

When used in combination with E3X-NA-F high speed unit. When used in combination with E3X-NA or E3X-SD standard units.

Type	Appearance (mm) *2	Sensing distance (mm)	Standard object (min. sensing object) (mm) *1	Min. bending radius (mm)	Features	Model number	
Environment-resistant models	Chemical-resistant		4,000*3 3,000 800 2,600 2,000 800 1,600 480	4 dia. (0.1 dia.)	R40	Fluorescein cover, long distance	E32-T12F
			500 400 100 320 250 100 200 60	3 dia. (0.1 dia.)		Fluorescein cover, side-view	E32-T14F
		1,800 1,400 350 1,190 920 350 700 200	4 dia. (0.1 dia.)	Fluorescein cover, heat-resistant up to 150°C *4		E32-T51F NEW	
		920 700 190 600 460 190 350 100	1 dia. (0.005 dia.)	Fluorescein cover, heat-resistant up to 200°C *5		E32-T81F-S	
Vacuum-resistant		260 200 50 170 130 50 100	1.2 dia. (0.01 dia.)	R30	M4 screw, heat-resistant up to 120°C	E32-T51V 1M	
		1,350 1,000 260 850 650 260 600	4 dia. (0.1 dia.)		M4 screw, heat-resistant up to 120°C, long distance	E32-T51V 1M+ E39-F1V	

*3. 2 m long on each side permitting a sensing distance of 4,000 mm.

*4. For continuous operation, use the product within a range of -40° to 130°C.

*5. The maximum temperature that can be withstood varies with location. Refer to dimensions diagrams for details.

: Flexible fiber : Bendable fiber : Fluorine-coated fiber

Ordering Information

Through-beam Fiber Units

*1. The values for the minimum sensing object are representative values that indicate values obtained in standard mode with the sensing distance and sensitivity set to optimum values.

*2. **Free-cut** Indicates models that allow free cutting.

High-resolution mode Standard mode Super-high-speed mode. When used in combination with the E3X-DA-S Amplifier Unit (general-purpose).

High-resolution mode Standard mode Super-high-speed mode. When used in combination with the E3X-MDA Unit.

When used in combination with E3X-NA-F high speed unit. When used in combination with E3X-NA or E3X-SD standard units.

Type	Appearance (mm) *2	Sensing distance (mm)	Standard object (min. sensing object) (mm) *1	Min. bending radius (mm)	Features	Model number
Environment-resistive models Vacuum-resistant		210 130 35 110 85 35 65	1.2 dia. (0.01 dia.)	R30	L-shaped, heat-resistant up to 120°C	E32-T54V 1M
		660 500 180 420 320 180 390	4 dia. (0.1 dia.)		L-shaped, heat-resistant up to 120°C, long distance	E32-T54V 1M+ E36-F1V
		630 480 130 410 310 130 250	2 dia. (0.1 dia.)	R25	L-shaped, heat-resistant up to 200°C, long distance	T32-T84SV 1M

Flanges

Appearance (mm)	Type	Model number
	4-channel flange	E32-VF4
	1-channel flange	E32-VF1

Lens Units

Appearance (mm)	Type	Quantity	Remarks
	E39-F1V	2	Long-distance Lens Unit Can be used for the E32-51V and the E32-T54V.

Mounting Brackets

Appearance (mm)	Type	Quantity	Remarks
	E39-L54V	2	Can be used for the E32-T54V.

Fiber Units for Atmospheric-pressure Side

Appearance	Type	Model number
	Amplifier-Flange Connection Fiber	E32-T10V 2M

Fiber Units with Reflective Sensors

*1. The sensing distances are for white paper.







*2. The values for the minimum sensing object are representative values that indicate values obtained in standard mode with the sensing distance and sensitivity set to optimum values.

*3. **Free-cut** Indicates models that allow free cutting.

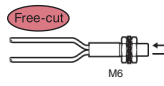
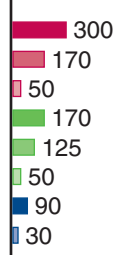
High-resolution mode **Standard mode** **Super-high-speed mode** When used in combination with the E3X-DA-S Amplifier Unit (general-purpose).

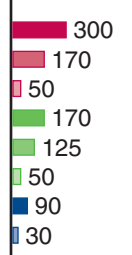
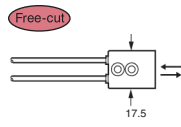
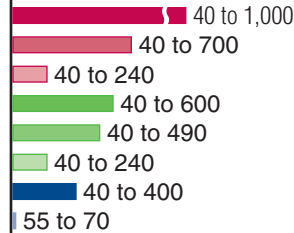
High-resolution mode **Standard mode** **Super-high-speed mode** When used in combination with the E3X-MDA Unit.

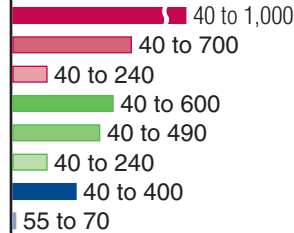
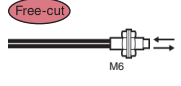
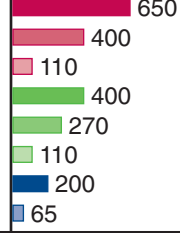
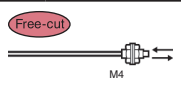
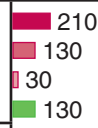
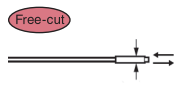
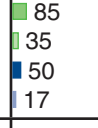
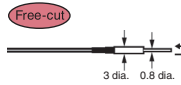
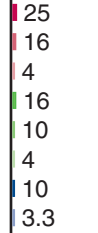
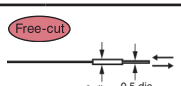
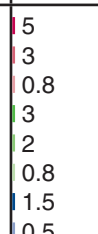
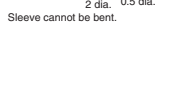
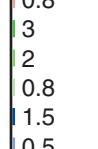
When used in combination with E3X-NA-F high speed unit. **When used in combination with E3X-NA or E3X-SD standard units.**

Type	Appearance (mm) *3	Sensing distance (mm) *1	Min. sensing object (mm) *2	Min. bending radius (mm)	Features	Model number						
Standard models	Chemical resistance 		(0.005 dia.)	 R4	M6 screw, fluorine coating	E32-D11U						
												
Special-beam models	Long-distance, high-power 		—	 R4	Large built-in lens, screw mounting	E32-D16						
												
	Long-distance, high-power 		(0.005 dia.)	R25	M6 screw	E32-D11L						
								R10	M4 screw	E32-D21L		
											3-dia. cylinder	E32-D22L
		 <p>Sleeve cannot be bent.</p>										
 <p>Sleeve cannot be bent.</p>		0.5-dia. sleeve	E32-D331									
 <p>Sleeve cannot be bent.</p>				0.5-dia. sleeve	E32-D331							
 <p>Sleeve cannot be bent.</p>						0.5-dia. sleeve	E32-D331					

 : Flexible fiber  : Bendable fiber  : Fluorine-coated fiber



Ordering Information

Fiber Units with Reflective Sensors

*1. The sensing distances are for white paper.





























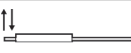







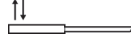





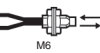

*2. The values for the minimum sensing object are representative values that indicate values obtained in standard mode with the sensing distance and sensitivity set to optimum values.

*3. **Free-cut** Indicates models that allow free cutting.

 High-resolution mode  Standard mode  Super-high-speed mode. When used in combination with the E3X-DA-S Amplifier Unit (general-purpose).



 High-resolution mode  Standard mode  Super-high-speed mode. When used in combination with the E3X-MDA Unit.

 When used in combination with E3X-NA-F high speed unit.  When used in combination with E3X-NA or E3X-SD standard units.

Type	Appearance (mm) *3	Sensing distance (mm) *1	Min. sensing object (mm) *2	Min. bending radius (mm)	Features	Model number
Special-beam models Limited-reflective	 	 2 to 6 (center: 4)  2 to 6 (center: 4)  2 to 6 (center: 4)  2 to 6 (center: 4)  2 to 6 (center: 4)  2 to 6 (center: 4)  2 to 6 (center: 4)	(0.005 dia.)	R10	Heat resistant up to 105°C *4, top-view	E32-L24L
	 	 5.4 to 9 (center: 7.2)  5.4 to 9 (center: 7.2)  5.4 to 9 (center: 7.2)  5.4 to 9 (center: 7.2)  5.4 to 9 (center: 7.2)  5.4 to 9 (center: 7.2)  5.4 to 9 (center: 7.2)			Heat resistant up to 105°C *4, top-view	E32-L25L
		 4 to 10  4 to 10  4 to 10  4 to 10  4 to 10  4 to 10  4 to 10			Heat resistant up to 200°C, flat-view	E32-L86 NEW
	 	 0 to 15  0 to 15  0 to 12  0 to 15  0 to 15  0 to 12  0 to 15  0 to 13			Wide-range sensing, flat-view	E32-L16
Environment-resistant models Heat-resistant	150°C  	 400  230  72  230  165  72  120  40	(0.005 dia.)	R35	Heat resistant up to 150°C	E32-D51

*4. For continuous operation, use the products within a temperature range of -40°C to 90°C.

*5. For continuous operation, use the products within a temperature range of -40°C to 130°C.

 : Flexible fiber  : Bendable fiber  : Fluorine-coated fiber

Fiber Units with Reflective Sensors

*1. The sensing distances are for white paper.



*2. The values for the minimum sensing object are representative values that indicate values obtained in standard mode with the sensing distance and sensitivity set to optimum values.

*3. **Free-cut** Indicates models that allow free cutting.

High-resolution mode **Standard mode** **Super-high-speed mode** When used in combination with the E3X-DA-S Amplifier Unit (general-purpose).

High-resolution mode **Standard mode** **Super-high-speed mode** When used in combination with the E3X-MDA Unit.

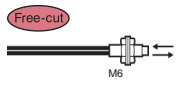
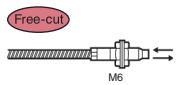
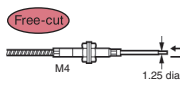
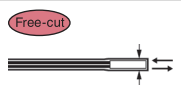
When used in combination with E3X-NA-F high speed unit. **When used in combination with E3X-NA or E3X-SD standard units.**

Type	Appearance (mm) *3	Sensing distance (mm) *1	Min. sensing object (mm) *2	Min. bending radius (mm)	Features	Model number		
Environment-resistant models	Heat-resistant	200°C  Free-cut	<ul style="list-style-type: none"> ■ 150 ■ 90 ■ 27 ■ 90 	(0.005 dia.)	R10	Heat resistant up to 200°C *4 E32-D81R-S E32-D81R		
		350°C  Free-cut	<ul style="list-style-type: none"> ■ 63 ■ 27 ■ 45 ■ 15 		R25	Heat resistant up to 350°C *4 E32-D61-S E32-D61		
		400°C  Free-cut Min. bending radius of sleeve: 10	<ul style="list-style-type: none"> ■ 100 ■ 60 ■ 18 ■ 60 ■ 40 ■ 18 ■ 30 ■ 10 		R25	Heat resistant up to 400°C *4, with sleeve E32-D73-S E32-D73		
	Chemical-resistant	 Free-cut	<ul style="list-style-type: none"> ■ 160 ■ 95 ■ 30 ■ 95 ■ 70 ■ 30 ■ 50 ■ 16 		(0.005 dia.)	U R40	Fluororesin cover, long distance	E32-D12F
		 Free-cut	<ul style="list-style-type: none"> ■ 70 ■ 40 ■ 10 ■ 40 ■ 28 ■ 10 ■ 20 ■ 6.5 				Fluororesin cover, side-view	E32-D14F NEW

*4. The maximum temperature that can be withstood varies with the location. Refer to dimensions diagrams for details.

R: Flexible fiber **B**: Bendable fiber **U**: Fluorine-coated fiber

Accessories

*1. The values for the minimum sensing object are representative values that indicate values obtained in standard mode with the sensing distance and sensitivity set to optimum values.

High-resolution mode Standard mode Super-high-speed mode When used in combination with the E3X-DA-S Amplifier Unit (general-purpose).

High-resolution mode Standard mode Super-high-speed mode When used in combination with the E3X-MDA Unit.

When used in combination with E3X-NA-F high speed unit. When used in combination with E3X-NA or E3X-SD standard units.

Lens Units

Type	Appearance	Applicable Fiber Units	Sensing distance (mm)	Standard object (min. sensing object) (mm) *1	Features	Lens model number
Through-beam Lens Units Long-distance Lens Units		E32-T11L	<ul style="list-style-type: none"> 4,000*2 3,200 840 1,100 870 350 700 210 	4 dia. (0.1 dia.)	Long-distance sensing; opening angle: 5° to 40° (heat resistant up to 200°C)	E39-F1
		E32-TC200	<ul style="list-style-type: none"> 4,000*2 4,000*2 1,500 4,000*2 3,700 1,500 3,000 900 			
		E32-T11R	<ul style="list-style-type: none"> 4,000*2 3,700 970 3,100 2,400 970 2,100 630 			
		E32-T11	<ul style="list-style-type: none"> 4,000*2 3,600 930 3,000 2,300 930 2,000 600 			
		E32-T11N	<ul style="list-style-type: none"> 4,000*2 3,700 970 3,100 2,400 970 2,100 630 			
		E32-T11U	<ul style="list-style-type: none"> 4,000*2 3,600 930 3,000 2,300 930 2,000 600 			

*2. The optical fiber is 2 m long on each side to permit a total sensing distance of 4,000 mm.

Ordering Information

Accessories

*1. The values for the minimum sensing object are representative values that indicate values obtained in standard mode with the sensing distance and sensitivity set to optimum values.

High-resolution mode Standard mode Super-high-speed mode When used in combination with the E3X-DA-S Amplifier Unit (general-purpose).

High-resolution mode Standard mode Super-high-speed mode When used in combination with the E3X-MDA Unit.

When used in combination with E3X-NA-F high speed unit. When used in combination with E3X-NA or E3X-SD standard units.

Type	Appearance	Applicable Fiber Units	Sensing distance (mm)	Standard object (min. sensing object) (mm) *1	Features	Lens model number
Long-distance Lens Units		E32-T81R-S	<ul style="list-style-type: none"> 2,650 2,100 520 1,600 1,300 520 1,050 380 	4 dia. (0.1 dia.)	Long-distance sensing; opening angle: 5° to 40° (heat resistant up to 200°C)	E39-F1
		E32-T61-S	<ul style="list-style-type: none"> 4,000*2 3,400 900 3,000 2,200 900 3,000 900 			
Through-beam Lens Units		E32-T11L	<ul style="list-style-type: none"> 910 800 180 600 520 180 500 150 	3 dia. (0.1 dia.)	Side-view, space-saving; opening angle: 20° to 60° (heat resistant up to 200°C)	E39-F2
		E32-TC200	<ul style="list-style-type: none"> 840 700 160 470 360 140 300 90 			
		E32-T11R	<ul style="list-style-type: none"> 520 400 100 330 260 100 220 65 			
		E32-T11	<ul style="list-style-type: none"> 820 660 160 530 430 160 360 100 			

*2. The optical fiber is 2 m long on each side to permit a total sensing distance of 4,000 mm.

Accessories

*1. Sensing distance when operated with E3X-DA-S amplifier





*2. Sensing distance when operated with E3X-MDA amplifier

*3. The values for the minimum sensing object are representative values that indicate values obtained in standard mode with the sensing distance and sensitivity set to optimum values.

High-resolution mode Standard mode Super-high-speed mode *When used in combination with the E3X-DA-S Amplifier Unit (general-purpose).

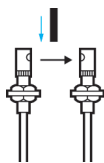
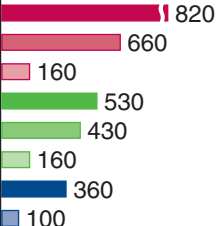
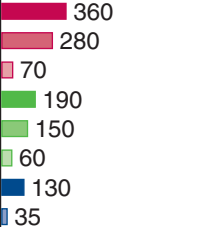
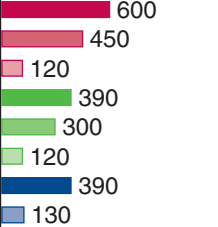
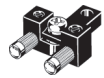
High-resolution mode Standard mode Super-high-speed mode *When used in combination with the E3X-MDA Unit.



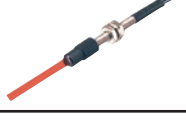

*When used in combination with E3X-NA-F high speed unit. *When used in combination with E3X-NA or E3X-SD standard units.

Type	Appearance	Applicable Fiber Units	Sensing distance (mm) *1	Standard object (min. sensing object) (mm) *3	Features	Lens model number
Through-beam Lens Units		E32-T11U		3 dia. (0.1 dia.)	Side-view, space-saving opening angle: 20° to 60° (heat resistant up to 200°C)	E39-F2
		E32-T81R-S				
		E32-T61-S				
Through-beam Lens Units		E32-T11L E32-TC200 E32-T11R E32-T11 E32-T11U E32-T81R-S E32-T61-S	—	—	Long distance reflection (heat resistant up to 200°C)	E39-F3
Small-spot Lens Units		E32-C42	Spot diameter variable in the range 0.1 to 0.6 mm at distances in the range 6 to 15 mm	Small spot (variable)	E39-F3A	
		E32-D32	Spot diameter variable in the range 0.5 to 1 mm at distances in the range 6 to 15 mm			
		E32-C41	0.1-dia. spot at a distance of 7 mm	Small spot	E39-F3A-5	
		E32-C31	0.5-dia. spot at a distance of 7 mm			
		E32-C41	0.2-dia. spot at a distance of 17 mm	Long distance, Small spot	E39-F3B	
		E32-C31	0.5-dia. spot at a distance of 17 mm			
	E32-C31 E32-C41	Spot diameter of 4 mm max. at distances in the range 0 to 20 mm	Long-distance sensing, parallel light	E39-F3C		

Ordering Information





Accessories

Protective Spiral Tube

Appearance	Application	Applicable Fiber Units	Tube length	Model number
	Fiber protection	M3-screw models E32-D21□ E32-DC200E E32-DC200F□ E32-C31	500 mm	E39-F32A5
			1 m	E39-F32A
		M3-screw models E32-T21□ (Except the E32-T21R.) E32-TC200E E32-TC200F□	500 mm	E39-F32B5
			1 m	E39-F32B
		M4-screw models E32-T11□ E32-TC200 E32-TC200B□ E32-T51	500 mm	E39-F32C5
			1 m	E39-F32C
		M6-screw models E32-D11□ E32-DC200 E32-DC200B E32-CC200□ E32-D51	500 mm	E39-F32D5
			1 m	E39-F32D

Note: Before using a Protective Spiral Tube, remove the protective tube that protects the area between the head and the optical fiber provided with some models.

Other Accessories

Appearance	Application	Name	Applicable Fiber Units	Remarks	Model number
	Used to cut the fiber.	Cutter	Fiber Units that allow free cutting	Provided with applicable Fiber Units.	E39-F4
	Attachments for inserting thin fibers into Amplifier Units	Thin-fiber Attachments	Fiber Units that allow free cutting and have a 1.0-dia. sheath	<ul style="list-style-type: none"> • 2 per set • Provided with applicable Fiber Units. 	E39-F9
	Used to extend fibers.	Fiber Connectors	Fiber Units that allow free cutting and have a 2.2-dia. sheath	—	E32-F10
	Easy-to-use, one-touch relay connectors		Fiber Units that allow free cutting	E39-F13: Used for Fiber Units with a 2.2-dia. sheath. E39-F14: Used for Fiber Units with a 1.0-dia. sheath. E39-F15: Used for Fiber Units with a sheath diameter between 1.0 and 2.2 mm.	E39-F13 E39-F14 E39-F15
	Used to bends in sleeves.		Sleeve Bender	E32-TC200B(4) E32-TC200F(4) E32-DC200F(4)	—

Ratings/Characteristics

Fiber Units

Item	Type	Environment-resistive models				
	Heat-resistant					
	E32-T5□ E32-D5□	E32-T8□R-S E32-D8□R-S	E32-T84S-S	E32-T6□-S E32-D6□-S	E32-D73-S	
Ambient operating temperature *1	-40°C to 150°C *4		-40°C to 200°C *3		-60°C to 350°C *3	-40°C to 400°C *3
Ambient humidity *1	35% to 85%					
Fiber material	Plastic (fluororesin coating)		Glass (fluororesin coating)	Glass (SUS spiral coating)		
Degree of protection	IEC standard: IP67					

Item	Type	Environment-resistive models				
	Chemical-resistant			Vacuum-resistant		
	All other models	E32-T51F	E32-T81F-S	All other models	32-T84SV	
Ambient operating temperature *1	-40°C to 70°C		-40°C to 150°C *4	-40°C to 200°C *3	-25°C to 120°C	-25°C to 200°C
Ambient humidity *1	35% to 85%					
Fiber material	Plastic (fluororesin coating)			Glass (fluororesin cover)	Glass (fluororesin coating)	Glass (SUS spiral coating)
Degree of protection	IEC standard: IP67			—		

Item	Type	Application-specific models				
	Label-detection	Liquid-level detection			Wafer-mapping	
		All other models	E32-A01 E32-A02	E32-D82F		
Ambient operating temperature *1	-40°C to 70°C			-40°C to 200°C *3	-40°C to 70°C	
Ambient humidity *1	35% to 85%					
Fiber material	Plastic (polyethylene coating)		Plastic (fluororesin coating)	Fluororesin cover	Plastic (polyethylene coating)	
Degree of protection	IEC standard: IP67	IEC standard: IP50		IEC standard: IP68	IEC standard: IP50	
Other		Repeat accuracy: 1 mm max.		Repeat accuracy: 0.5 mm max.		

Item	Type	Application-specific models				
	Glass-substrate-alignment		Glass-substrate-mapping			
	All other models	E32-L66	E32-A09	E32-A09H	E32-A09H2	
Ambient operating temperature *1	-40°C to 70°C		0°C to 300°C *3, *5	-40°C to 70°C	-40°C to 150°C *4	-40°C to 300°C *3
Ambient humidity *1	35% to 85%					
Fiber material	Plastic (polyethylene coating)	Glass (SUS spiral coating)	Plastic (polyethylene coating)	Plastic (fluororesin coating)	Glass (SUS spiral coating)	
Degree of protection	IEC standard: IP40					

*1. There must be no icing or condensation within the range specified for the ambient operating temperature.
 *2. For continuous operation, use the products within a temperature range of -40°C to 90°C.
 *3. The maximum temperature that can be withstood varies with the location. Refer to dimensions diagrams for details.
 *4. For continuous operation, use the products within a temperature range of -40°C to 130°C.
 *5. These values are based on the assumption that there are no repeated sudden changes in temperature.

Through-beam Fiber Units

Area-sensing Models

E32-ET16WR-1

Free-cut

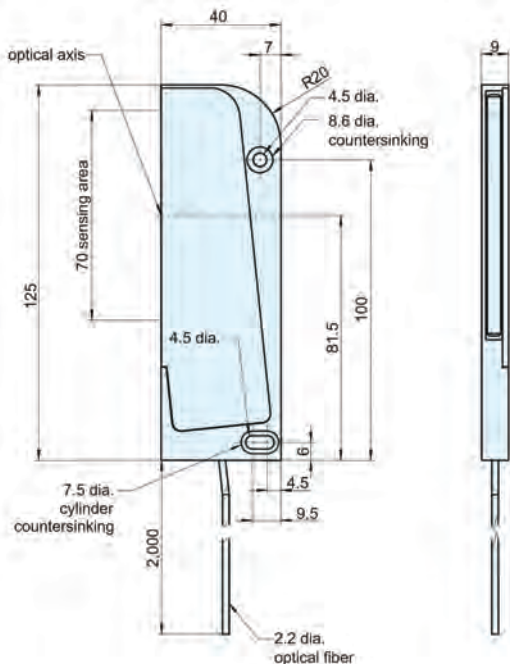

E32-ET16WR-2

Free-cut

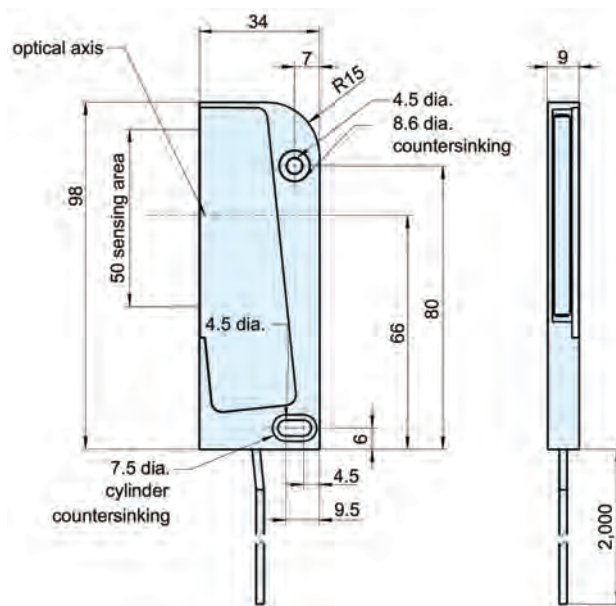

E32-T16P
E32-T16PR

Free-cut

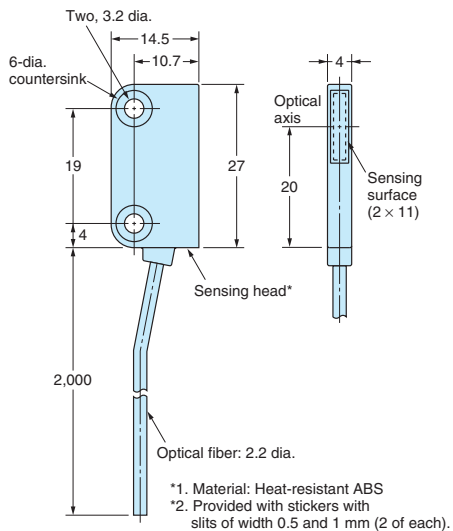

E32-T16J
E32-T16JR

Free-cut

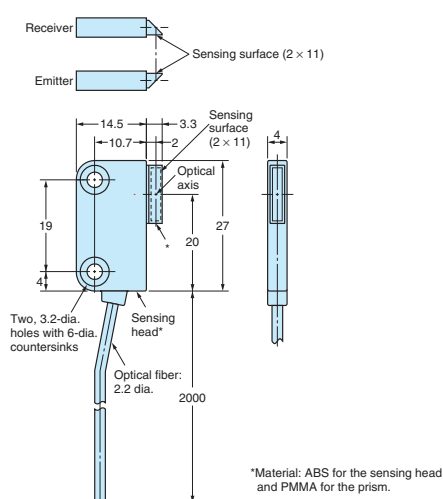

E32-T16

Free-cut

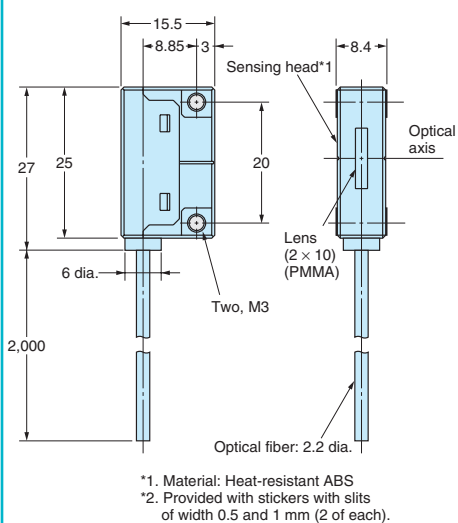

Heat-resistant Models

E32-T51

Free-cut

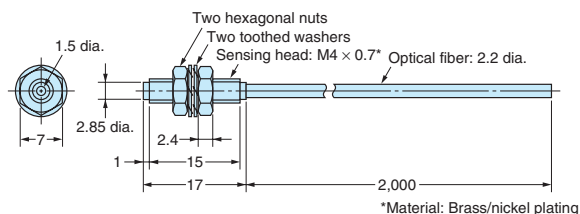

Note: The maximum allowable temperature is 150°C. The maximum allowable temperature for continuous operation is 130°C.

E32-T54

Free-cut

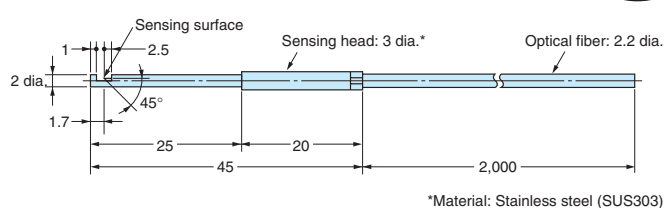

Note: The maximum allowable temperature is 150°C. The maximum allowable temperature for continuous operation is 130°C.

Dimensions

Through-beam Fiber Units

Heat-resistant Models

Free-cut Indicates models that allow free cutting.

E32-T81R-S

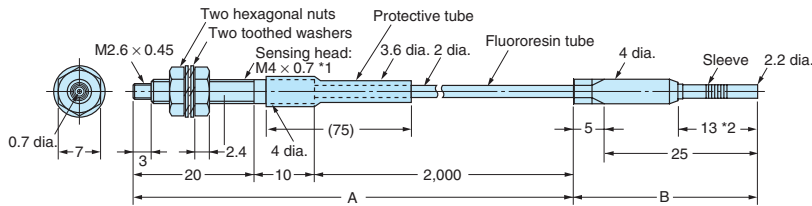

*1. Material: Stainless steel (SUS303)

Note: The maximum allowable temperature for section A and B are 200°C. and 110°C, respectively. The section inserted into Amplifier unit (indicated by *2), however, must stay within the Amplifier Unit's operating temperature range.

E32-T84S-S

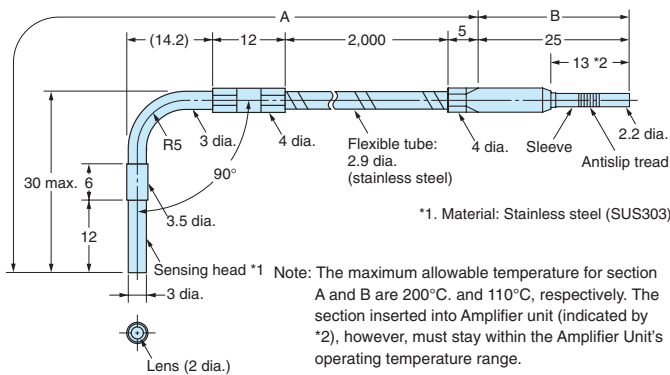

Note: The maximum allowable temperature for section A and B are 200°C. and 110°C, respectively. The section inserted into Amplifier unit (indicated by *2), however, must stay within the Amplifier Unit's operating temperature range.

E32-T61-S

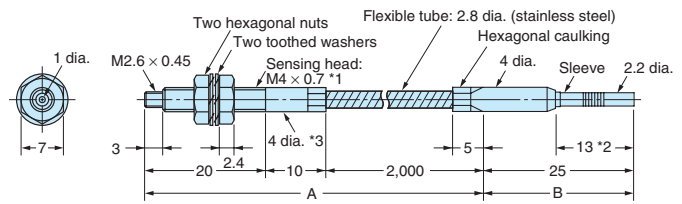

*1. Material: Stainless steel (SUS303)
*3. The diameter is 6 mm if the fiber length exceeds 10 m.

Note: The maximum allowable temperature for section A and B are 200°C. and 110°C, respectively. The section inserted into Amplifier unit (indicated by *2), however, must stay within the Amplifier Unit's operating temperature range.

Chemical-resistant Models

E32-T11F

Free-cut

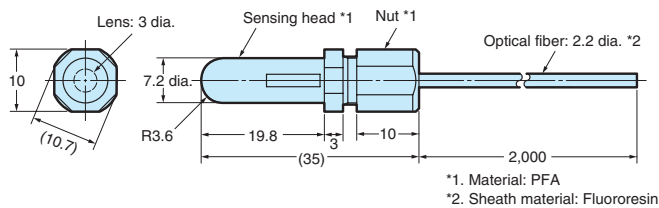

E32-T12F

Free-cut

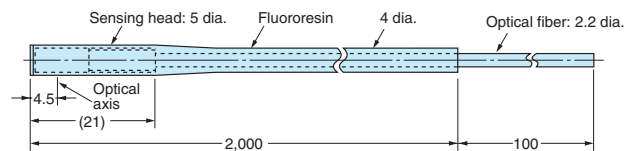

E32-T14F

Free-cut

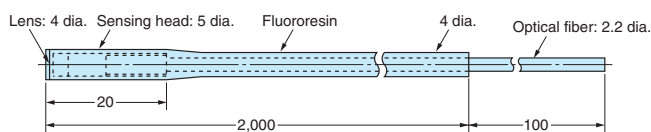

E32-T51F

Free-cut

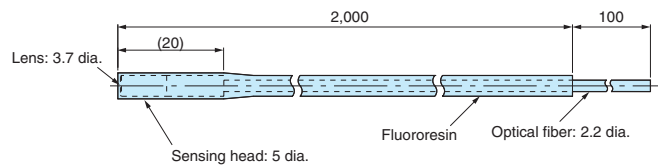

E32-T81F-S

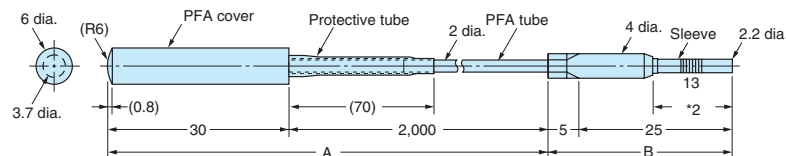

Note: The maximum allowable temperature for section A and B are 200°C. and 110°C, respectively. The section inserted into Amplifier unit (indicated by *2), however, must stay within the Amplifier Unit's operating temperature range.

Through-beam Fiber Units

Vacuum-resistant Models

E32-T51V

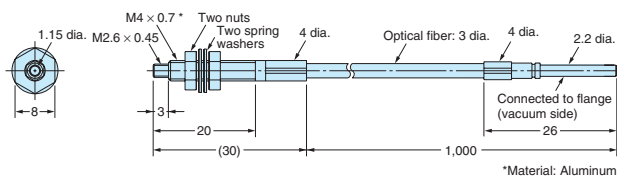

E32-T54V

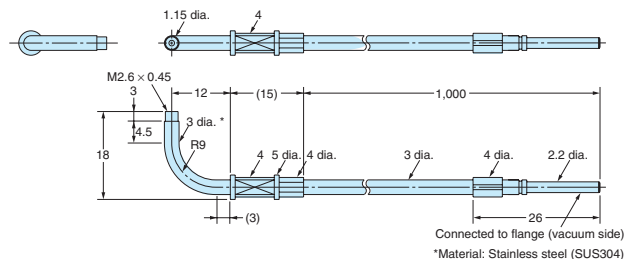

E32-T84SV

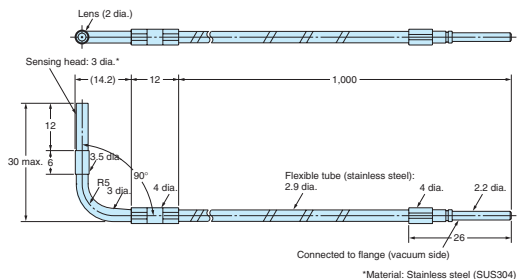

E39-F1V

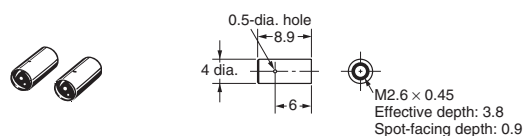

E32-VF4

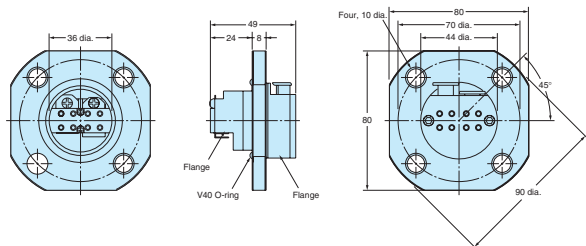

- Note 1. Perform mounting so that the V15 O-ring is on the atmospheric-pressure side of the vacuum chamber wall.
2. Mounting-hole cutout dimensions: 14.5 dia. ±0.2 mm

E32-VF1

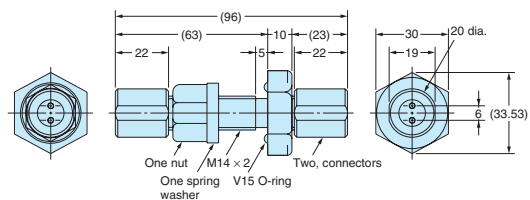

- Note 1. Perform mounting so that the V15 O-ring is on the atmospheric-pressure side of the vacuum chamber wall.
2. Mounting-hole cutout dimensions: 14.5 dia. ±0.2 mm

Fiber Units with Reflective Sensors

Limited-reflective Models

E32-L25

Free-cut

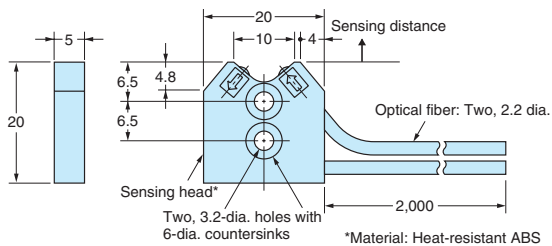

Note: There is a white line on the fiber that is inserted in the emitter-side port.

E32-L25A

Free-cut

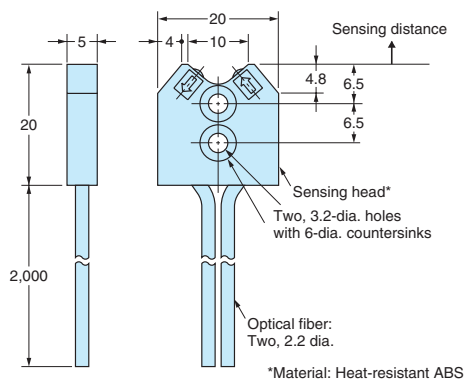

Note: There is a white line on the fiber that is inserted in the emitter-side port.

E32-L86

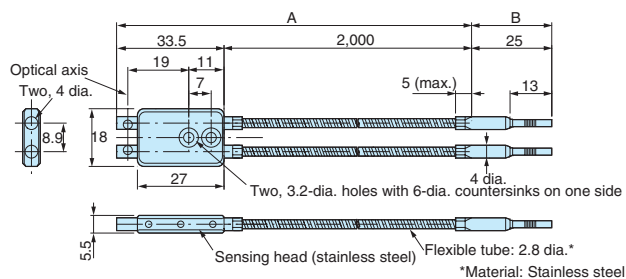

Note: The maximum allowable temperature for section A and B are 200°C. and 110°C, respectively. The section inserted into Amplifier unit (indicated by *2), however, must stay within the Amplifier Unit's operating temperature range.

Heat-resistant Models

E32-D51

Free-cut

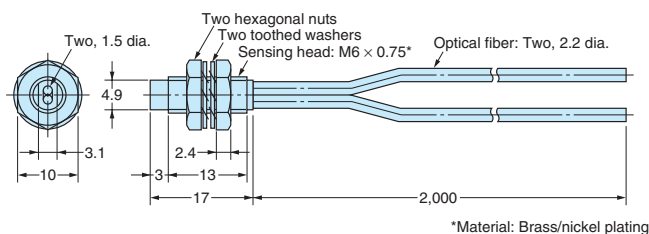

Note: The maximum allowable temperature is 150°C. The maximum allowable temperature for continuous operation is 130°C.

E32-D81R-S

E32-D81R

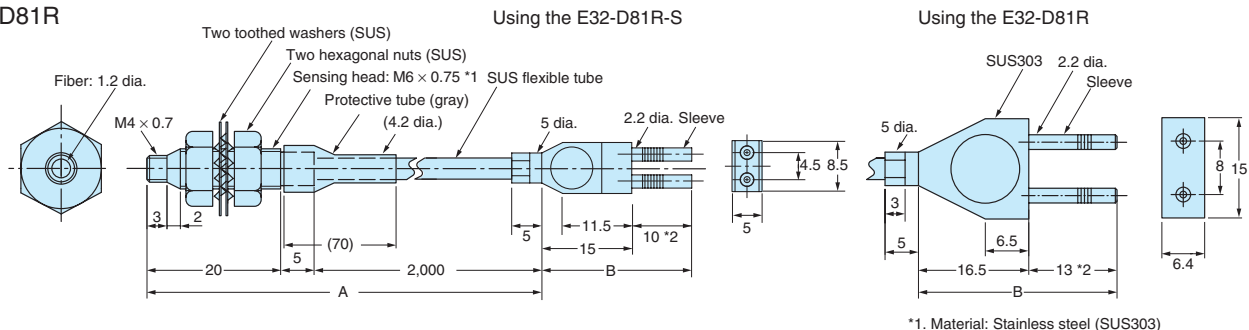

Note: The maximum allowable temperature for section A and B are 200°C. and 110°C, respectively. The section inserted into Amplifier unit (indicated by *2), however, must stay within the Amplifier Unit's operating temperature range.

Dimensions

Fiber Units with Reflective Sensors

Heat-resistant Models

Free-cut Indicates models that allow free cutting.

E32-D61-S
E32-D61

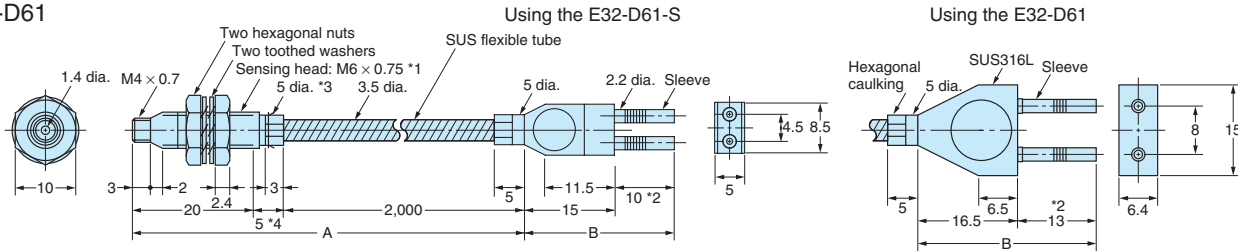

*1. Material: Stainless steel (SUS303)
*3. The diameter is 6 if the fiber length exceeds 10 m.
*4. The diameter is 10 if the fiber length exceeds 10 m.

Note: The maximum allowable temperature for section A and B are 200°C. and 110°C, respectively. The section inserted into Amplifier unit (indicated by *2), however, must stay within the Amplifier Unit's operating temperature range.

E32-D73-S
E32-D73

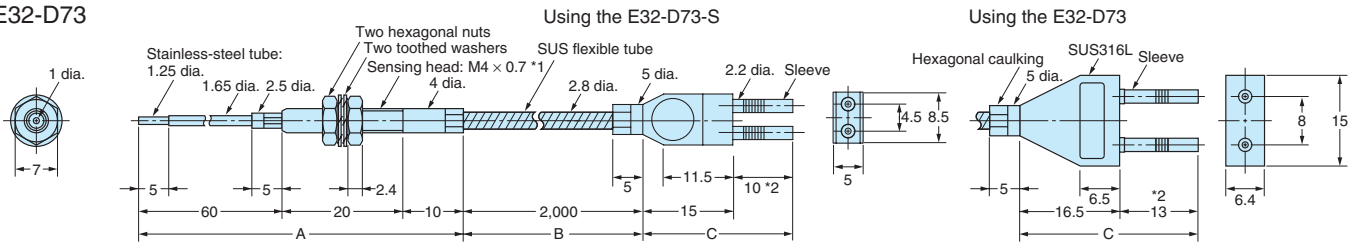

*1. Material: Stainless steel (SUS303)

Note: The maximum allowable temperature for section A and B are 200°C. and 110°C, respectively. The section inserted into Amplifier unit (indicated by *2), however, must stay within the Amplifier Unit's operating temperature range.

Chemical-resistant Models

E32-D12F

Free-cut

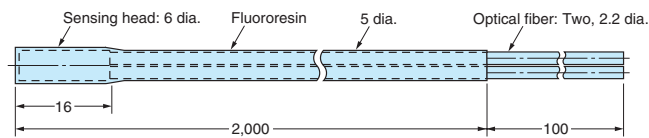

E32-D14F

Free-cut

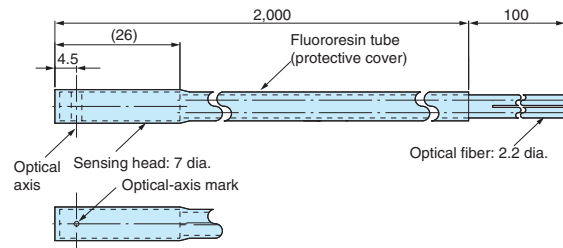

Application-specific Fiber Units

Label-detection Models

E32-G14

Free-cut

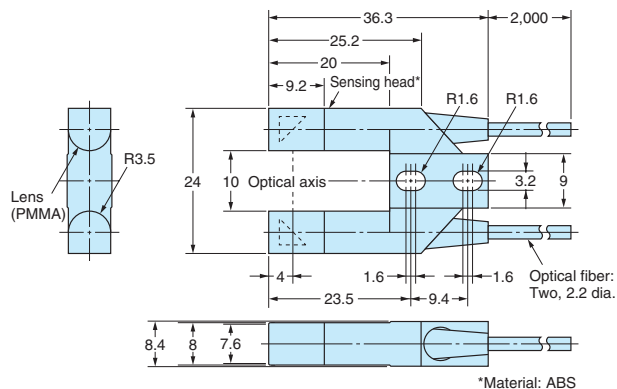

Liquid-level Detection Models

E32-D36T

Free-cut

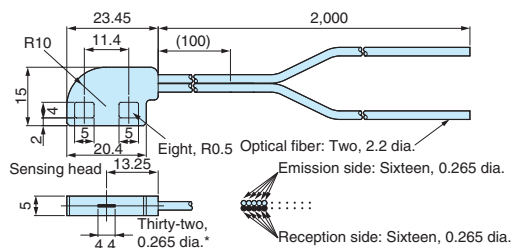

E32-L25T

Free-cut

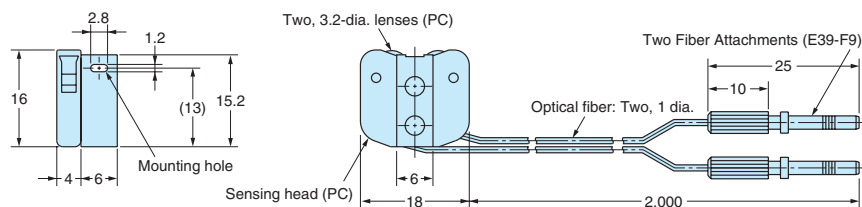

E32-A01

Free-cut

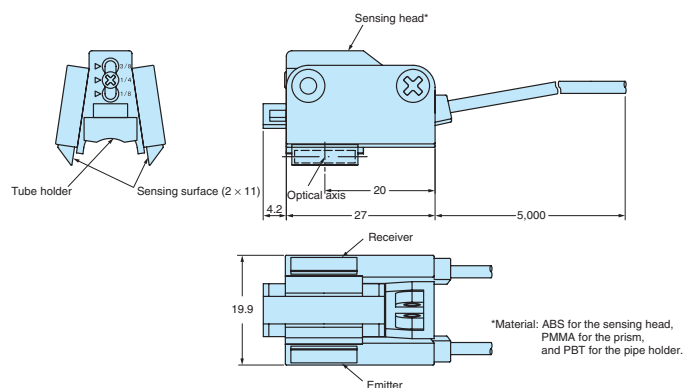

E32-A02

Free-cut

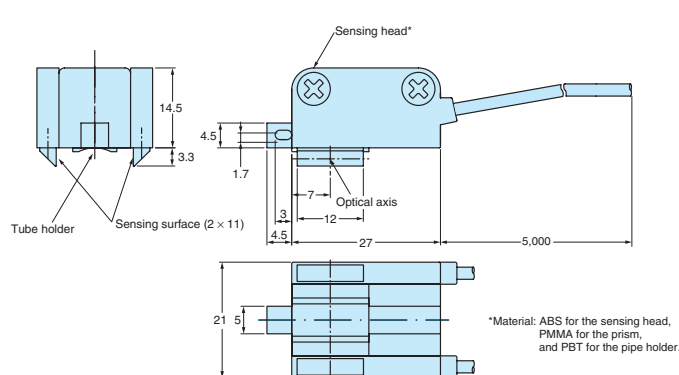

Dimensions

Application-specific Fiber Units

Liquid-level Detection Models

Free-cut Indicates models that allow free cutting.

E32-D82F1
E32-D82F2

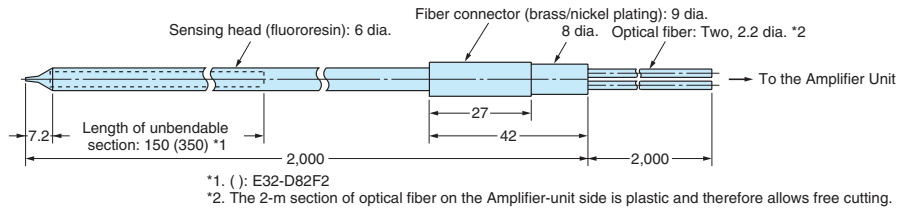

Models for Glass-substrate Alignment/Mapping

E32-A08
E32-A07E1(E2)

Free-cut

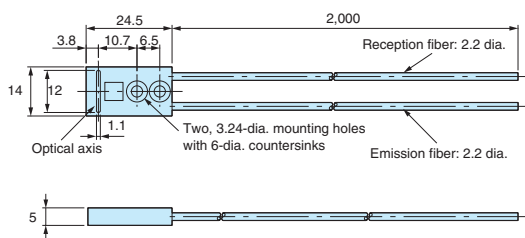

E32-L66

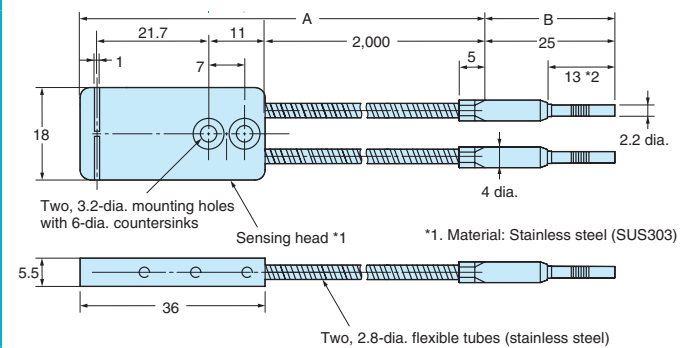

Note: The maximum allowable temperature for section A and B are 200°C. and 110°C, respectively. The section inserted into Amplifier unit (indicated by *2), however, must stay within the Amplifier Unit's operating temperature range.

E32-A09
E32-A09H

Free-cut

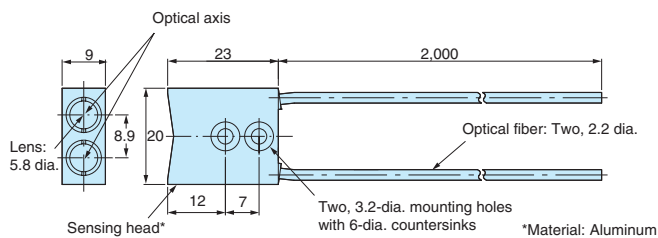

E32-A09H2

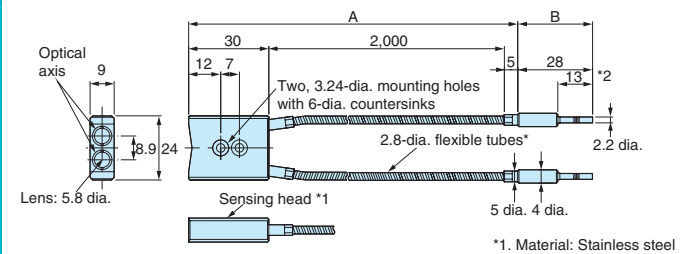

Note: The maximum allowable temperature for section A and B are 200°C. and 110°C, respectively. The section inserted into Amplifier unit (indicated by *2), however, must stay within the Amplifier Unit's operating temperature range.

Wafer-mapping Models

E32-A03

Free-cut

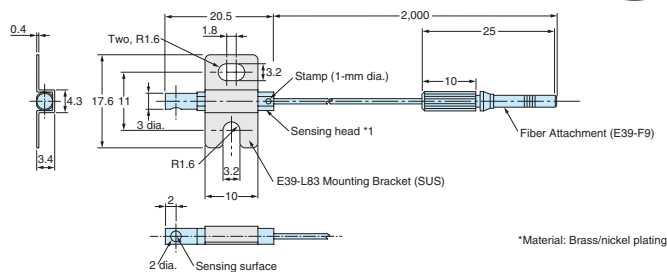

E32-A03-1

Free-cut

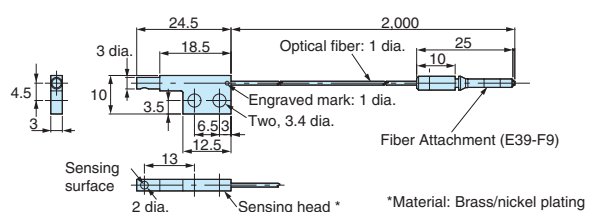

Dimensions

Accessories

Protective Spiral Tubes

E39-F32A/F32A5
E39-E32B/F32B5

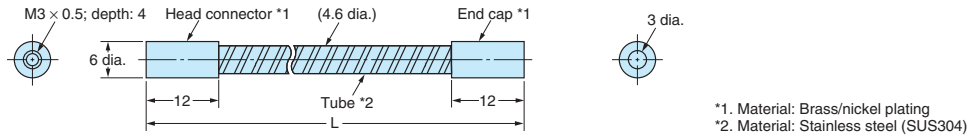

Note: 1. The length L is 1,000 for the E39-F32A/-F32B and 500 for the E39-F32A5/-F32B5.
2. The E39-F32B(5) consists of two E39-F32A(5)s.

E39-F32C/F32C5

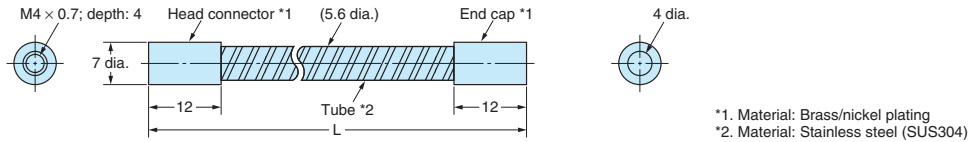

Note: The length L is 1,000 for the E39-F32C and 500 for the E39-F32C5.

E39-F32D/F32D5

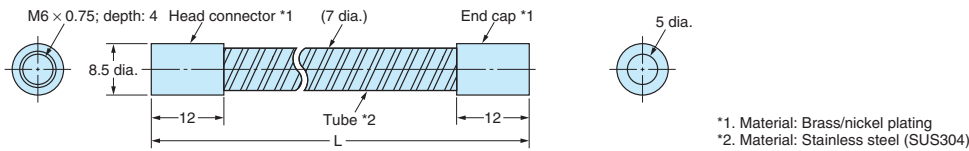

Note: The length L is 1,000 for the E39-F32D and 500 for the E39-F32D5.

Other Accessories

Fiber Cutter
E39-F4

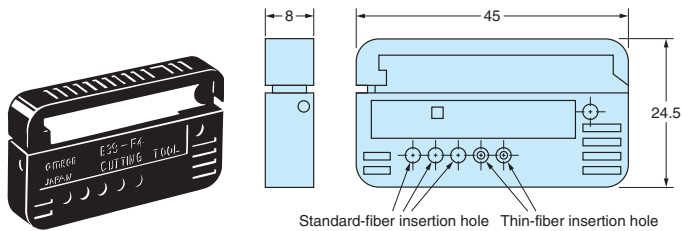

Thin-fiber Attachments
E39-F9

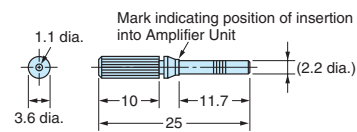

Note: Two per set.
*Provided with thin-fiber models.

Fiber Connector
E39-F10

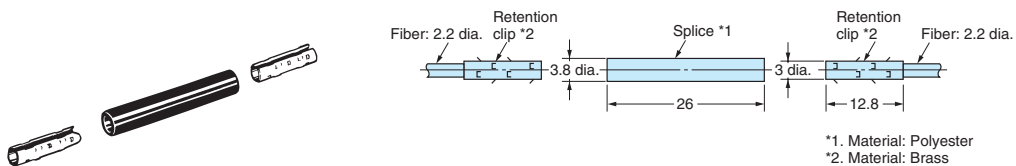

Fiber Connector
E39-F13
E39-F14
E39-F15

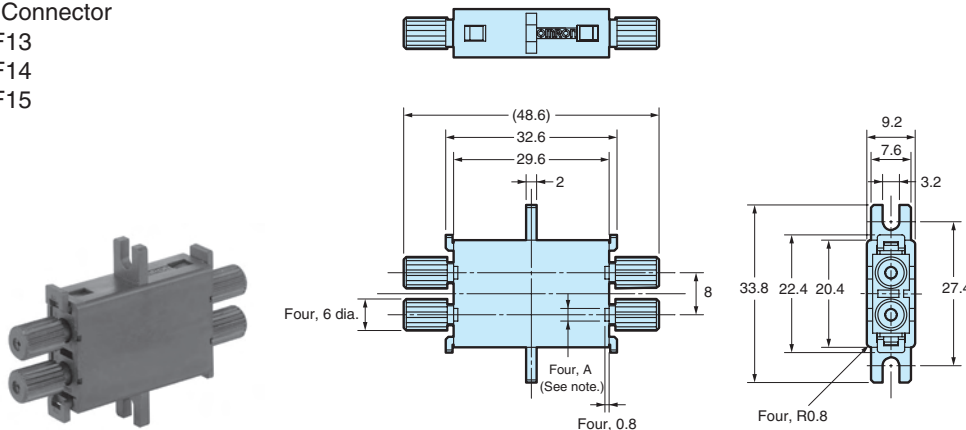

Note: Dimension A varies with the model number as shown in the following table.

Model	Dimension A
E39-F13	2.4
E39-F14	1.2
E39-F15	2.4/1.2

Accessories

Other Accessories

Sleeve Bender
E39-F11

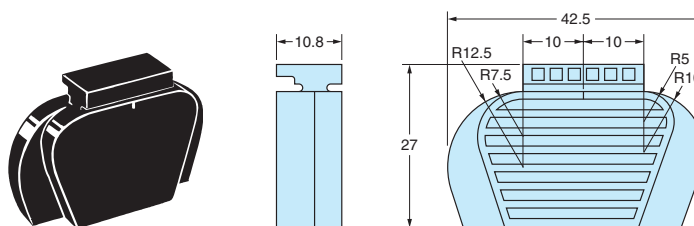

Lens Units

Lens Units
E39-F1

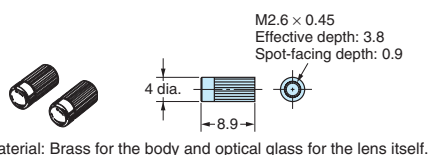

Material: Brass for the body and optical glass for the lens itself.

Note: Two per set.

Side-view units
E39-F2

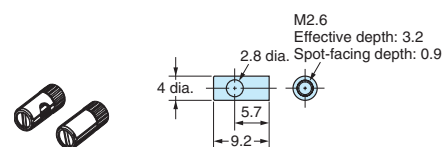

Material: Brass for the body and optical glass for the lens itself.

Note: Two per set.

Reflection Unit with Lens
E39-F3

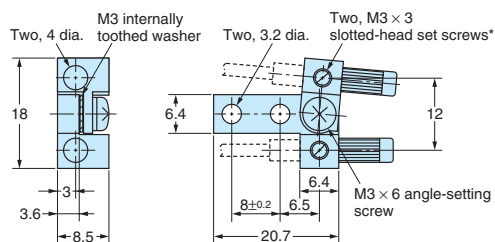

Material: Brass for the body and aluminum for the base.

* Secure the fiber head with the slotted-head set screws. Do not insert a lens (E39-F1).

Lens Unit for Reflective Fiber Units
E39-F3A

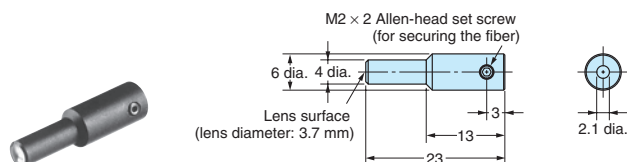

Material: Aluminum for body and optical glass, for the lens.

Note: This is the Lens Unit for the E32-D32 and E32-C42.

Lens Unit for Reflective Fiber Units
E39-F3A-5

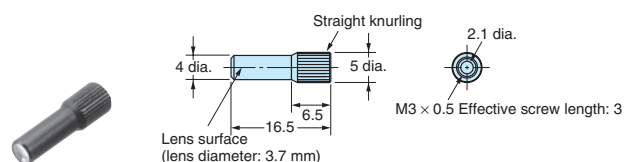

Material: Aluminum for body and optical glass, for the lens.

Note: This is the Lens Unit for the E32-C31 and E32-C41.

Lens Unit for Reflective Fiber Units
E39-F3B

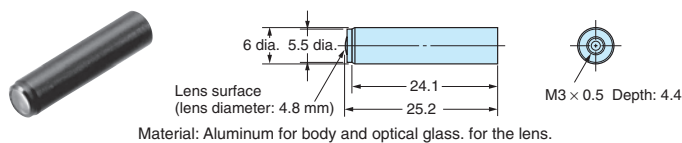

Material: Aluminum for body and optical glass, for the lens.

Note: This is the Lens Unit for the E32-C31 and E32-C41.

Lens Unit for Reflective Fiber Units
E39-F3C

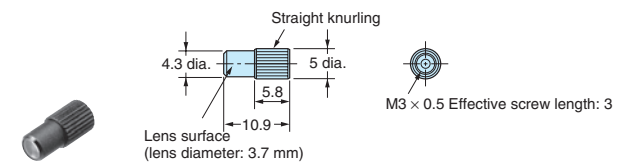

Material: Aluminum for body and optical glass, for the lens.

Note: This is the Lens Unit for the E32-C31 and E32-C41.

Precautions

Precautions for Correct Use

■ Fiber Units Mounting

Tightening Force

The tightening force applied to the Fiber Unit should be as follows:

Screw-mounting Model

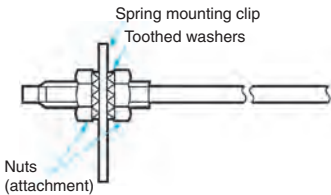

Cylindrical Model

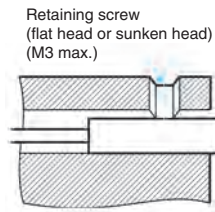

Fiber Units	Clamping torque
M6 screw/6-mm dia. cylinder	0.98 N·m max.
M3/M4 screw	0.78 N·m max.
2-mm dia./3-mm dia. cylinder	0.29 N·m max.
1.5-mm dia./1-mm dia. cylinder	0.2 N·m max.
E32-T12F 5-mm dia. fluororesin model	0.78 N·m max.
E32-D12F 6-mm dia. fluororesin model	
E32-L25A	
E32-M21	Up to 5 mm to the tip: 0.49 N·m max. More than 5 mm from the tip: 0.78 N·m max.
E32-T16	0.49 N·m max.
E32-R21	0.39 N·m max.
E32-T16W(R) E32-T16P(R) E32-T16J(R) E32-L24S E32-L24L E32-T25L	0.29 N·m max.

Use a proper-sized wrench.



Fiber Cutting Procedure

Cut a thin fiber as follows:

①	An attachment is temporarily fitted to a thin fiber before shipment.	 Thin fiber attachment (E39-F9) Temporarily fitted
②	Secure the attachment after adjusting the position of it in the direction indicated by the arrow.	 Temporarily fitted
③	Insert the fiber to be cut into the E39-F4.	 Cutter (E39-F4) Two holes for thin fiber Three holes for standard fiber (2.2-mm dia.)
④	Finished state (proper cutting state)	 Approx. 0.5 mm Insertion direction

Note: Insert the fiber in the direction indicated by arrow.

Connection

- Do not pull or press the Fiber Units. The Fiber Units have a withstand force of 9.8 N or 29.4 N maximum.
- Do not bend the Fiber Unit beyond the permissible bending radius given under *Ordering Information*.
- Do not bend the edge of the Fiber Units (excluding the E32-T□R and E32-D□R).

Correct

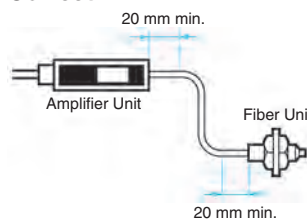

Incorrect



- Do not apply excess force on the Fiber Units.

Correct

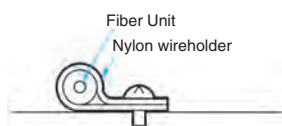

Incorrect



The Fiber Head could be broken by excessive vibration. To prevent this, the following is effective:

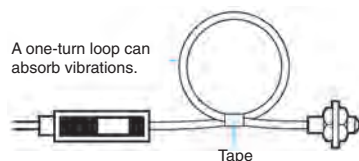

E39-F11 Sleeve Bender

- The bending radius of the stainless steel tube should be as large as possible. The smaller the bending radius becomes, the shorter the sensing distance will be.
- Insert the tip of the stainless steel tube to the Sleeve Bender and bend the stainless steel tube slowly along the curve of the Sleeve Bender (refer to the figure).

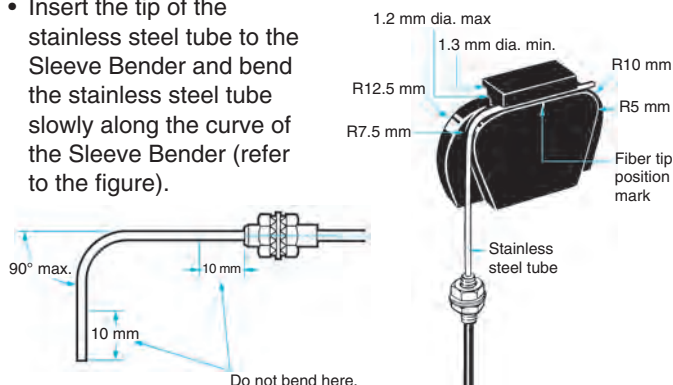

Heat-resistant Fiber Units (E32-D51 and E32-T51)

- The fibers of these Units cannot be extended using the E39-F10 Fiber Connector.
- The maximum allowable temperature for continuous operation with these Units is 130°C. It is 150°C for short-term use.

E32-T14 and E32-G14

These Units may enter the light-ON state if there are reflecting objects at the ends of the lenses. In this case, attach the black stickers provided to the ends of the lenses.



Wafer Sensors (E32-L25(A))

- To ensure correct performance, insert the fiber with a white line into the emitter-side port of the Amplifier Unit.

E32-T16 and E32-T16P

Example

E32-T16's sensing head

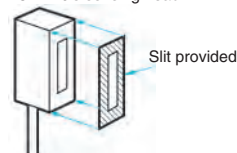

To use the slit provided, peel off the backing sheet, align it with the edges of the sensing surface, and attach it to the sensing head. Use the slit in applications where saturation occurs (i.e., changes in light intensity cannot be obtained) due to short sensing distances.

E32-M21

Separate the 4 fibers by distances sufficient to prevent interference.

Vacuum-resistant Fiber Units (E32-V)

Although Flanges, Fiber Units on the vacuum side, and Lens Units have been cleaned, as an extra precaution, clean these products with alcohol before use in high-vacuum environments to ensure that they are properly degreased.

Liquid-level Detection Sensors (E32-D82F)

- Secure the Fiber Unit using the unbendable section. Otherwise, the liquid-level detection position may be displaced.
- For applications in hazardous environments, install the Fiber Unit in the hazardous environment but install the Amplifier Unit in a safe environment.

Liquid-level Detection Sensors: Tube-mounting Models

- Ensure that the tube is not deformed when using a band to secure the Fiber Unit.
- Drops of water, bubbles, or haze inside the tube may cause malfunctions.

Adjustment E32-G14

The sensing distance is short, making the incident light intensity large. This makes it impossible to teach without a workpiece. Perform teaching with and without a workpiece.

Liquid-level (E32-D82F) Detection Position

The liquid-level detection position is at a distance of 5.2 ± 2 mm from the end of the fluororesin section. (Refer to the diagram on the right.)

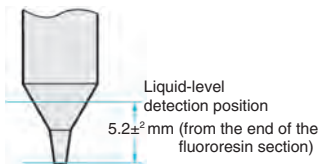

The liquid-level detection position varies with the surface tension of the liquid and the degree of wetness at the Fiber Unit's detection position.

Other Considerations

Liquid Level (E32-D82F)

- Operation may become unstable in the following cases:
 - ① Bubbles stick to the cone of the sensing head.
 - ② Solute is deposited on the cone of the sensing head.
 - ③ The liquid has a high viscosity.
- There are some liquids, such as milky white liquids, for which detection is not possible.
- Do not let the end of the fluororesin section bump into another object. Damage to, or deformation of, the sensing head may result in unstable operation.

Heat-resistant Fiber Units (E32-D81R, E32-D61, and E32-D73)

The pitch of the emission-side and reception-side fiber-insertion ports varies with the Amplifier Unit. Be sure to use an appropriate Fiber Unit.

Amplifier Unit	Fiber Unit
E3X-DA□-S E3X-MDA□	E32-D□-S
E3X-DA□-N E3X-NA□	E32-D□

Precautions

■ Accessories

Use of E39-R3 Reflector

1. Use detergent, etc., to remove any dust or oil from the surfaces where tape is applied. Adhesive tape will not be attached properly if oil or dust remains on the surface.
2. The E39-R3 cannot be used in places where it is exposed to oil or chemicals.

E39-F32□ Protective Spiral Tubes

1. Insert a fiber to the Protective Spiral Tube from the head connector side (screwed) of the tube.

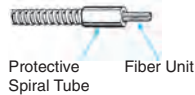

2. Push the fiber into the Protective Spiral Tube. The tube should be straight so that the fiber is not twisted when inserted. Then turn the end cap of the spiral tube.

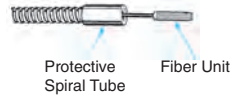

3. Secure the Protective Spiral Tube on a suitable place with the attached nut.

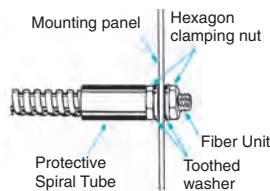

4. Use the attached saddle to secure the end cap of the Protective Spiral Tube. To secure the Protective Spiral Tube at a position other than the end cap, apply tape to the tube so that the portion becomes thicker in diameter.

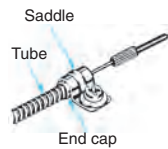

E39-F10 Fiber Connector

Mount the Fiber Connector as shown in the following illustrations.

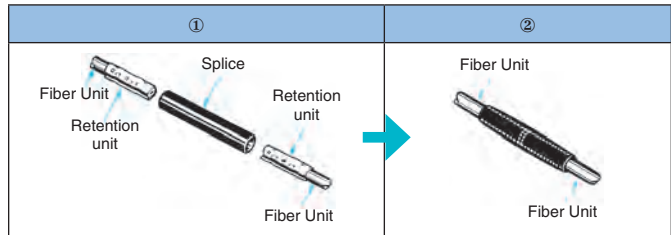

- The Fiber Units should be as close as possible when they are connected. Sensing distance will be reduced by approximately 25% when fibers are connected.
- Only 2.2-mm dia. fibers can be connected.

Simple Fiber Optic Amplifiers

E3X-SD with Digital Display, E3X-NA with Bar Graph Display

E3X-SD Features

- Streamlined features provide basic sensing immediately after plug-in
- Easy push button teach with or without workpiece
- Large, 6 mm wide digital display provides read-out of incident and operating level
- Incident settings and management can be performed reliably with 0 to 999% (10 times) fin tune adjustment
- Built-in OFF-delay, ON-delay, one-shot timer
- Optical communication design prevents mutual interference for up to 5 amplifiers
- Pre-wired (2 m cable) and wire-saving connector models available





E3X-NA Features

- Streamlined features provide basic sensing immediately after plug-in
- Use the LED bar display to quickly confirm sensor performance
- Optical communication design prevents mutual interference for up to 5 amplifiers
- Green LED models address mark-detecting applications
- High-speed models have a response time of 50 micro-seconds (μ s)
- IP66 Water-resistant models available with M8 connector or pre-wired with 2 m cable





■ Ordering Information

Amplifier Units

Digital Display and Direct Key Setting

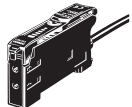
Item	Appearance	Connection method	Ratings and Specifications	Model	
				NPN output	PNP output
Standard models		Pre-wired	—	E3X-SD11	E3X-SD41
		Wire-saving connector		E3X-SD6	E3X-SD8

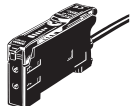
Bar Display and Adjuster Setting

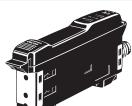
Item	Appearance	Connection method	Ratings and Specifications	Model	
				NPN output	PNP output
Standard models		Pre-wired	—	E3X-NA11	E3X-NA41
		Wire-saving connector		E3X-NA6	E3X-NA8
High-speed detection models		Pre-wired	Response time: 20 μs	E3X-NA11F	E3X-NA41F
Water-resistant		Pre-wired	Degree of protection: IP66	E3X-NA11V	E3X-NA41V
		Connector (MB)		E3X-NA14V	E3X-NA44V

■ Specifications

Item	Type	Digital display and direct key setting	Bar display and adjuster setting		
	Model	Standard models	Standard models	High-speed detection models	Water-resistant models
		EX-SD□	E3X-NA□	E3X-NA□F	E3X-NA□V
Light source (wavelength)		Red LED (620 nm)	Red LED (680 nm)		
Power supply voltage		12 to 24 VDC ±10%, ripple (p-p): 10% max.			
Current consumption		960 mW max. (Power supply: 24 V, Current consumption: 40mA max.)	35 mA max.		
Control output		Open-collector output (NPN or PNP) Load power supply: 26.4 V max., Load current: 50 mA max. (Residual voltage: 1.5 V max.) (*1) Light-ON/Dark-ON mode selector			
Protection circuits		Power supply reverse polarity protection, output short-circuit protection, output reverse polarity protection (*2)			
Timer function		ON/OFF-delay timer: 10 ms (each fixed)	OFF-delay timer: 40 ms (fixed)		
Mutual interference prevention		Up to 5 Amplifiers (optically synchronized)	None	Up to 5 Amplifiers (optically synchronized)	
Weight (packed state)		Pre-wired model: Approx. 100 g, Model with connector: Approx. 55 g (*3)			

Note: *1. For the E3X-NA, residual voltage is 1V max.

*2. The E3X-NA does not have output reverse polarity prevention.

*3. Add 10 g for water-resistant models.

E3X-DA-S Dual Display Digital Fiber Optic Amplifier

Features

- Dual digital display can monitor current and preset values, including digital, bar, percent and hold display functions
- Power tuning function addresses saturation or insufficient light conditions
- 4-element LED and Auto Power Control ensure stable, long term performance
- Three inspection speeds/distances in one model: standard, high-speed and high-resolution
- Advanced functions include differential operation for minute object detection, 2 independent outputs for area detection, remote input function and counter function
- Advanced models available for Mark Detection; Two-Outputs for Area output, self-diagnostics or differential operation; external input for remote setting
- Optical communications ports built into each sensor enables data exchange with one another and the Omron Mobile Console remote control
- Pre-wired (2 m cable) and wire-saving connector models available

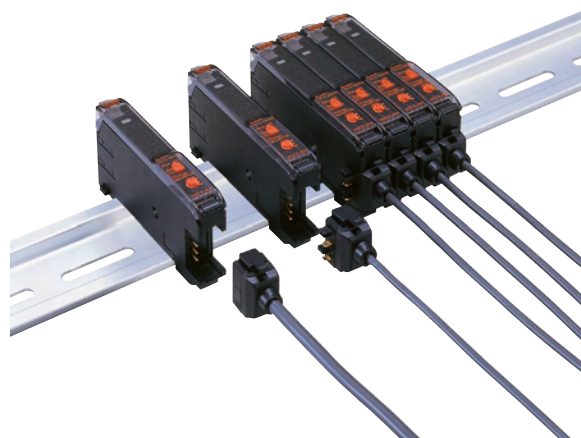

Ordering Information

Amplifier Units with Cables

Item	Appearance	Functions	Model		
			NPN output	PNP output	
Standard models		—	E3X-DA11-S	E3X-DA41-S	
Mark-detecting models		Green LED	—	E3X-DAG11-S	E3X-DAG41-S
		Blue LED	—	E3X-DAB11-S	E3X-DAB41-S
Advanced models		Two-output models	Area output, self-diagnosis, differential operation	E3X-DA11TW-S	E3X-DA41TW-S
		External-input models	Remote setting, counter, differential operation	E3X-DA11RM-S	E3X-DA41RM-S

Amplifier Units with Connectors

Item	Appearance	Functions	Model		
			NPN output	PNP output	
Standard models		—	E3X-DA6-S	E3X-DA8-S	
Mark-detecting models		Green LED	—	E3X-DAG6-S	E3X-DAG8-S
		Blue LED	—	E3X-DAB6-S	E3X-DAB8-S
Advanced models		Two-output models	Area output, self-diagnosis, differential operation	E3X-DA6TW-S	E3X-DA8TW-S
		External-input models	Remote setting, counter, differential operation	E3X-DA6RM-S	E3X-DA8RM-S

■ Specifications

Item	Type		Standard models	Mark-detecting models		Advanced, two-output models	Advanced, external-input models
	Model	NPN output	E3X-DA11-S	E3X-DAG11-S	E3X-DAB11-S	E3X-DA11TW-S	E3X-DA11RM-S
		PNP output	E3X-DA41-S	E3X-DAG41-S	E3X-DAB41-S	E3X-DA41TW-S	E3X-DA41RM-S
Light source (wavelength)			Red LED (650 nm)	Green LED (525 nm)	Blue LED (470 nm)	Red LED (650 nm)	
Supply voltage			12 to 24 VDC \pm 10%, ripple (p-p) 10% max.				
Power consumption			960 mW max. (current consumption: 40 mA max. at power supply voltage of 24 VDC)			1,080 mW max. (current consumption: 45 mA max. at power supply voltage of 24 VDC)	
Control output			Load power supply voltage: 26.4 VDC; NPN/PNP open collector; load current: 50 mA max.; residual voltage: 1 V max.				
Circuit protection			Reverse polarity for power supply connection, output short-circuit				
Response time	High-speed mode	NPN	48 μ s for operation and 50 μ s for reset			80 μ s for operation and reset respectively	48 μ s for operation and 50 μ s for reset (*1)
		PNP	53 μ s for operation and 55 μ s for reset				53 μ s for operation and 55 μ s for reset (*1)
	Standard mode		1 ms for operation and reset respectively				
	High-resolution mode		4 ms for operation and reset respectively				
Functions	Power tuning		Light emission power and reception gain, digital control method				
	Differential detection		—			Switchable between single edge and double edge detection mode Single edge: Can be set to 250 μ s, 500 μ s, 1 ms, 10 ms, or 100 ms. Double edge: Can be set to 500 μ s, 1 ms, 2 ms, or 200 ms.	
	Timer function		Select from OFF-delay, or one-shot timer. 1 ms to 5 s (1 to 20 ms set in 1-ms increments, 20 to 200 ms set in 10-ms increments, 200 ms to 1 s set in 100-ms increments, and 1 to 5 s set in 1 s-increments)				
	Automatic power control (APC)		High-speed control method for emission current				
	Zero-reset		Display can be reset to zero when required (negative values can be displayed).				
	Initial reset		Settings can be returned to defaults as required.				
	Mutual interference prevention		Possible for up to 10 Units. (*2, *3)				
	Counter		—			Switchable between up counter and down counter. Set count: 0 to 9,999,999	
I/O settings		—			Output setting (Select from channel 2 out-put, area output, or self-diagnosis.) External input setting (Select from teaching, power tuning, zero reset, light OFF, or counter reset.)		
Weight (packed state)			Approx. 100 g				

Note: *1. When counter is enabled: 80 μ s for operation and reset respectively.

*2. Communications are disabled if the detection mode is selected during high-speed mode; the communications functions for mutual interference prevention and the Mobile Console will not function.

*3. Mutual interference prevention can be used for up to 6 Units if power tuning is enabled.

E3X-MDA Two-channel Dual Display Digital Amplifier



Features

- Two independent fiber-optic amplifiers in a slim, 10 mm wide track-mount unit
- Designed for gang mounting up to 18 sensors (9 units)
- Dual digital display can monitor current and preset values, including digital, bar, percent and hold display functions
- Three inspection speeds/distances in one model: standard, high-speed and high-resolution
- Logical AND/OR control output for local control in high-speed applications
- 4-element LED and Auto Power Control ensure stable, long term performance
- Optical communications ports built into each sensor enables data exchange with one another and the Omron Mobile Console remote control
- Pre-wired (2 m cable) and wire-saving connector models available



Ordering Information

Dual Amplifiers

Sensing heads	Setup	Features	Light source	Connection method	Model	
					NPN output	PNP output
Order E32 fiber-optic cables separately		And/OR logic output 3 sensing speeds	Red (650 nm)	Pre-wired	E3X-MDA11	E3X-MDA41
		One master connector for ganged units		Connector	E3X-MDA6	E3X-MDA8

■ Specifications

Item	Model	Type	2-channel models	
		NPN output	E3X-MDA11	E3X-MDA6
		PNP output	E3X-MDA41	E3X-MDA8
Light source (wavelength)		Red LED (650 nm)		
Supply voltage		12 to 24 VDC ±10%, ripple (p-p) 10% max.		
Power consumption		1,080 mW max. (current consumption: 45 mA max. at power supply voltage of 24 VDC)		
Control output		Load power supply voltage: 26.4 VDC; NPN/PNP open collector; load current: 50 mA max.; residual voltage: 1 V max.		
Circuit protection		Reverse polarity for power supply connection, output short-circuit		
Response time	High-speed mode	NPN	130 μs (*1) for operation and reset respectively	
		PNP		
	Standard mode	1 ms for operation and reset respectively		
	High-resolution mode		4 ms for operation and reset respectively	
Functions	Power tuning		Light emission power and reception gain, digital control method	
	Timer function		Select from OFF-delay, or ON-delay, one-shot timer. 1 ms to 5 s (1 to 20 ms set in 1-ms increments, 20 to 200 ms set in 10-ms increments, 200 ms to 1 s set in 100-ms increments, and 1 to 5 s set in 1 s-increments)	
	Automatic power control (APC)		High-speed control method for emission current	
	Zero-reset		Display can be reset to zero when required (negative values can be displayed).	
	Initial reset		Settings can be returned to defaults as required.	
	Mutual interference prevention		Possible for up to 9 Units (18 channels) (*2, *3)	
I/O settings		Output setting (Select from channel 2 output, AND, OR, leading edge sync, falling edge sync, or differential output)		
Weight (packed state)		Approx. 100 g		Approx. 55 g

Note: *1. When differential output is selected for the output setting, the second channel output is 200 μs for the operation and reset respectively.

*2. Communications are disabled if the detection mode is selected during high-speed mode; the communications functions for mutual interference prevention and the Mobile Console will not function.

*3. Mutual interference prevention can be used for up to 5 Units (10 channels) if power tuning is enabled.

E3X-DAC-S True Color Fiber Optic Amplifiers with Digital Dual Display

Features

- Reliability through precise and true color detection with White LED emitter and RGB (Red, Green and Blue) processing
- Enhanced stability: workpiece movement does not affect the sensor as the receiver element processes light as a ratio to compensate for intensity variations
- Easy push button setup guides the user to place the workpiece in an appropriate position for teaching
- Full-functional, dual digital display can monitor current preset values, including digital, bar, percent and hold display functions
- On-Board timing function incorporating OFF-delay, On-delay, and one-shot timing functions
- Advanced models offer remote control as well as twin sensing and output to simultaneously distinguish between two registered colors
- Pre-wired (2 m cable) and wire-saving connector models available

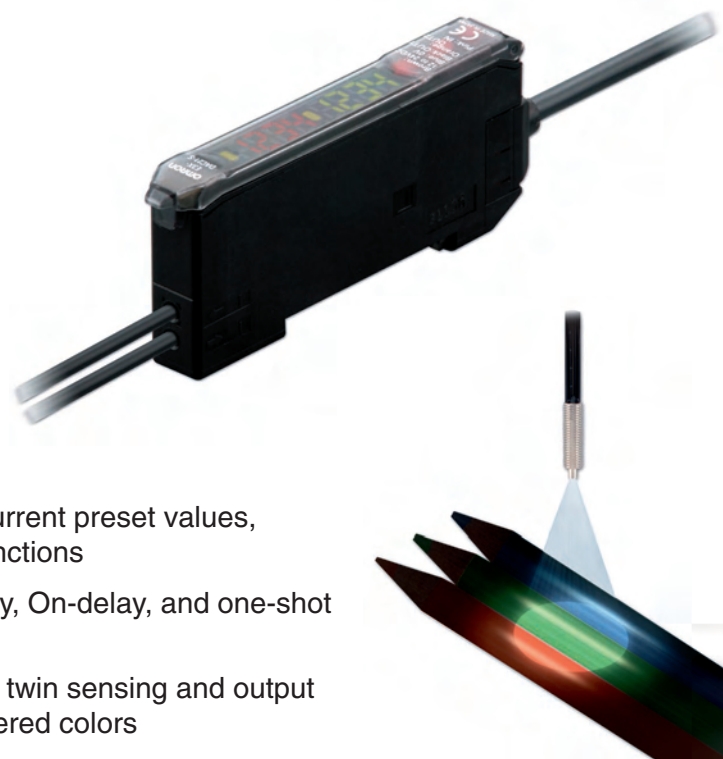

■ Ordering Information

Amplifier Units

Amplifier Units with Cables

Item	Appearance	Functions	Model	
			NPN output	PNP output
Standard models		Timer, Response speed change	E3X-DAC11-S	E3X-DAC41-S
Advanced models		Standard models + Simultaneous determination (2 colors) AND/OR output, Remote setting	E3X-DAC21-S	E3X-DAC51-S

Amplifier Units with Connectors (Amplifier Unit Connectors must be purchased separately.)

Item	Appearance	Functions	Model	
			NPN output	PNP output
Standard models		Timer, Response speed change	E3X-DAC6-S	E3X-DAC8-S

■ Specifications

Item	Type	Standard models	Advanced models
	Model	E3X-DAC□-S□ (□: 11/41/6/8)	E3X-DAC□-S□ (□: 21/51)
Light source (wavelength)	White LED (420 to 700 nm)		
Sensing method	C Mode: RGB ratio determination (or I Mode: Light intensity determination for red, green, or blue) (*1)		
	Number of registered colors	1	2 (simultaneous determination)
Power supply voltage	12 to 24 VDC ±10%, ripple (p-p) 10% max.		
Power consumption	960 mW max. (current consumption: 40 mA max. at power supply voltage of 24 VDC)		
Control output	NPN or PNP open collector Load power supply voltage: 26.4 VDC max. load current: 50 mA max. (residual voltage: 2 V max.)		
Remote control input	—	No-voltage input (contact/transistor)	
Protection circuits	Reverse polarity for power supply connection, output short-circuit, Reversed output polarity protection		
Response time	Super-high-speed mode (*2)	Operate or reset: 60 μs	Operate or reset: 120 μs
	High-speed mode	Operate or reset: 300 μs	Operate or reset: 600 μs
	Standard mode	Operate or reset: 1 ms	Operate or reset: 2 ms
	High-resolution mode	Operate or reset: 4 ms	Operate or reset: 8 ms
Functions	Operating mode	ON for match (ON for same color as registered color) or ON for mismatched (ON for different color from registered color)	
	Timer function	Timer type: OFF delay, ON delay, or one-short Timer range: 1 ms to 5 s (variable)	
	Control outputs	—	Output for each channel, AND output, and OR output
	Remote control	—	One-point teaching, teaching with/without workpiece, zero reset, and light emission OFF
	Display switch (*3)	Seven patterns total: Match + Threshold + Margin + Threshold, Analog bar display, Peak + Bottom, etc.	
	Initialization	Initial reset (factory defaults) or user reset (saved settings)	
Weight (packed state)	Pre-wired model: Approx. 100g, Amplifier unit connector model: Approx. 55 g		

Note: *1. When teaching with/without a workpiece, the best sensing method will be automatically selected (RGB ratio (C Mode) or light intensity determination (I Mode)).

If color differences are not strong enough and RGB ratios would result in unstable detection, then light intensity determination (I Mode) will be selected.

*2. Mutual interference prevention cannot be used in super-high-speed mode, and light intensity determination (I Mode) must be used.

*3. With light intensity determination (I Mode), the correlation is not displayed, but rather the light intensity is displayed.

Wire-Saving Connector Models

- Streamlines installation and maintenance to reduce service time
- Unique connector design reduces wiring and space requirement because one master connector supplies power to all other slave connectors
- Detach the sensor without disturbing the fiber installation or output wiring for servicing

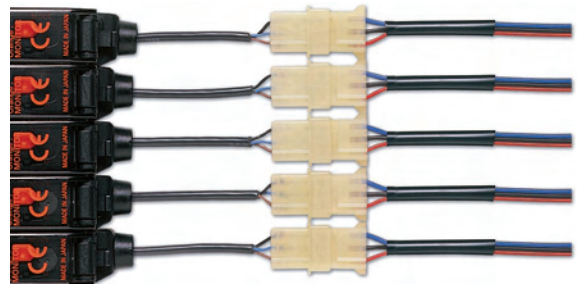

Pre-wired models
require three wiring connections for each sensor.
Shown: 15 wires plus extension connector wires.



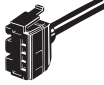
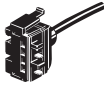

The **E3X-DA-S** requires three wiring connections for the master sensor only. Each additional sensor in a group requires only one wiring connection.
Shown: ONLY 7 WIRES with no additional extension connectors.

Connectors





Description	Appearance	Compatible amplifiers	Cable length	Conductors	Model
Master connector (for first unit)		E3X-DA6-S, E3X-DA8-S, E3X-DAG6-S, E3X-DAG8-S, E3X-DAB6-S, E3X-DAB8-S, E3X-DAC6-S, E3X-DAC8-S, E3X-NA6, E3X-NA8, E3X-SD6, E3X-SD8	2 m	3	E3X-CN11
		E3X-DA6TW-S, E3X-DA8TW-S, E3X-DA6RM-S, E3X-DA8RM-S, E3X-MDA6, E3X-MDA8, E3C-LDA6, E3C-LDA7, E3C-LDA8, E3C-LDA9	2 m	4	E3X-CN21
Slave connector (for second and additional units)		E3X-DA6-S, E3X-DA8-S, E3X-DAG6-S, E3X-DAG8-S, E3X-DAB6-S, E3X-DAB8-S, E3X-DAC6-S, E3X-DAC8-S, E3X-NA6, E3X-NA8, E3X-SD6, E3X-SD8	2 m	1	E3X-CN12
		E3X-DA6TW-S, E3X-DA8TW-S, E3X-DA6RM-S, E3X-DA8RM-S, E3X-MDA6, E3X-MDA8, E3C-LDA6, E3C-LDA7, E3C-LDA8, E3C-LDA9	2 m	2	E3X-CN22

M8 Connectors

Use these connectors with water-resistant E3X-NA14V and E3X-NA44V amplifiers only.

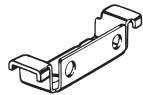
Size	Cable specifications	Appearance	Cable type		Model
M8	Standard cable	Straight connector 	2m	Four-conductor cable	XS3F-M421-402-A
			5m		XS3F-M421-405-A
		L-shaped connector 	2m		XS3F-M422-402-A
			5m		XS3F-M422-405-A



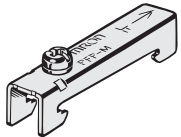

Mounting Bracket and Track

Description	Appearance	Dimensions H x W x D mm	Specification	Model
Surface mounting bracket		7.3 H x 35 W x 12 D	304 stainless steel; fits the DIN track holder	E39-L143
Mounting track		500 L x 35 H x 7.3 D	0.5 m length	PFP-50N
		1000 L x 35 H x 7.3 D	1 m length	PFP-100N
		1000 L x 35 H x 16.0 D	1 m length	PFP-100N2
End plate		50 x 10 x 10	Holds track-mounted devices in place	PFP-M

Mobile Console

- Program and monitor the following amplifiers remotely with mobile console: E3X-DA-S, E3X-MDA, E3C-LDA
- Console includes 1.5 m cable for remote setup connection to the programming head
- Programming head track mounts flush against leftmost amplifier
- AC adapter powers console



Description	Appearance/ Dimensions	Model
Mobile console kit Includes console, programming head, cable and AC adapter		E3X-MC11-SV2
Mobile console (only)	 136 H x 52.8 W x 22 D mm	E3X-MC11-C1-SV2
Programming head (only) Mounts on DIN rail	 51.3 H x 20 W x 30.3 D mm	E3X-MC11-H1
Cable	 1.5 m length	E3X-Z12-1

Fiber Optic or Laser Optic Sensor Communication Unit Supports Multi-vendor Networks

- ON/OFF signals and incident light levels can be sent to the host
- PLC without any need for programming (using the Remote I/O Communications Slave function).
- Threshold values and function settings can be read, written, or taught (using the Message Communications function).
- Device parameters prepared on a personal computer connected to the network can be downloaded in a batch operation (using the Configurator).

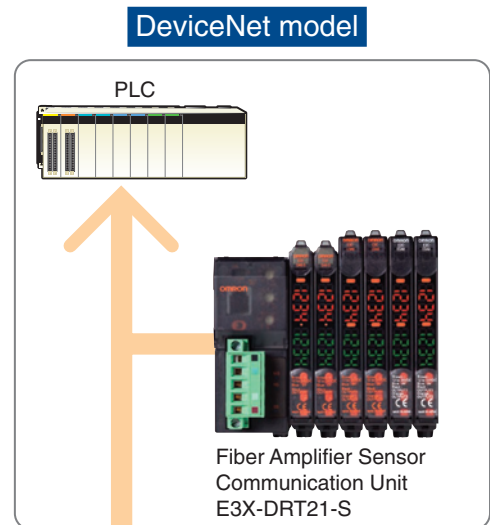

A Network That Expands Your World

Configurator
Download a group of parameters for devices (Sensors, Temperature Controllers, etc., supporting DeviceNet) that you have prepared on your personal computer in a single batch.

DeviceNet

Optical Communications

Mobile Console
A built-in interface for a Mobile Console lets you bring setting and confirmation operations to your fingertips.

PLC

Monitor operating hours.
The operating hours for sensors can be stored in internal memory and used for planning maintenance and other applications.

Supports a wide range of sensors.
The Unit supports a variety of digital sensors, including Fiber Sensors, Laser Sensors, and Proximity Sensors.

Up to 16 channels can be connected.

■ Ordering Information

Fiber Amplifier Sensor Communication Unit

Type	Model
DeviceNet	EX-DRT21-S

Wire-reducing Connector

Type	Model
Cordless Slave Connector	E3X-CN02

■ Ratings and Specifications

Item	Description	
Communications Methods	DeviceNet communications	
Communications functions	Remote I/O Communications Slave function	Monitors ON/OFF output, status, incident light level (digital display data)
	Message Communications functions	Sets parameters using Explicit messages
	Configurator	Edits slave devices parameters, enables device monitor functions
Mobile Console connection	E3X-MC11-S-V2 can be connected	
Power supply	Supplied from the DeviceNet communications connector(power is also supplied to all connected Sensors through Wire-reducing Connectors)	
Maximum connectable Sensors	13 or 16 (depending on the operation mode)	
Connectable Sensors	E3X-DA-S Series or E3X-MDA Series Digital Fiber Sensor E3C-LDA Series Laser Photoelectric Sensor with Separate Digital Amplifier E2C-EDA High-resolution Digital Proximity Sensor with Separate Amplifier (use connector-type Amplifier Units and the E3X-CN02 Cordless Slave Connector)	
Power supply voltage	11 to 25 VDC	
Current consumption (See note.)	70 mA max.	
Ambient operating temperature	-20 to 55°C	
Ambient operating humidity	35% to 85% (with no condensation)	
Storage temperature	-30 to 70°C	
Dimensions (mm)	30 x 34.6 x 71.3 (W x H x D)	
Weight (packed state)	Approx. 150 g	

Note: This does not include the current supplied to the Sensor.

Fiber Optic Amplifiers

Amplifier Units with Cables

- E3X-SD11
- E3X-SD41
- E3X-NA11
- E3X-NA11F
- E3X-NA41
- E3X-NA41F

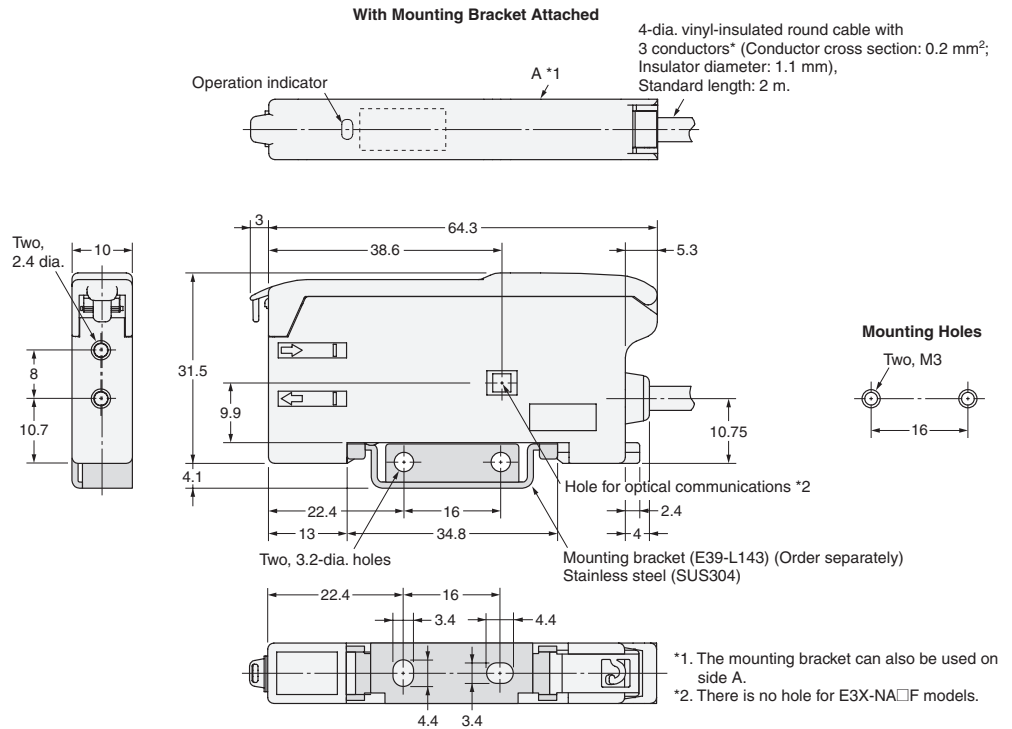

Amplifier Units with Connectors

- E3X-SD6
- E3X-SD8
- E3X-NA6
- E3X-NA8

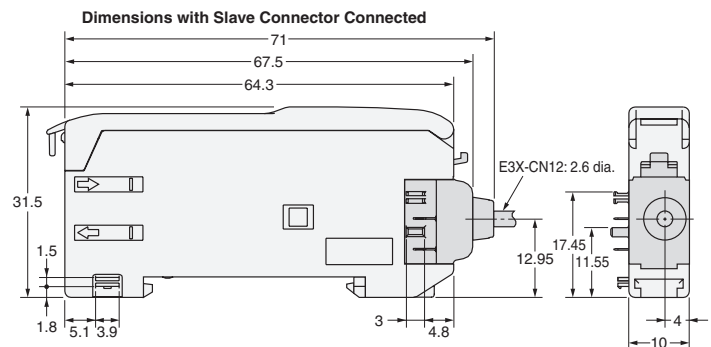
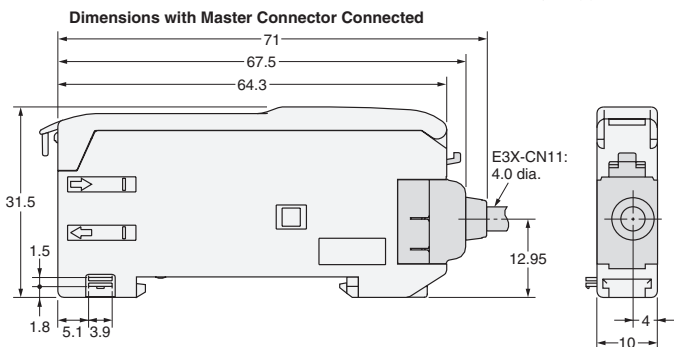
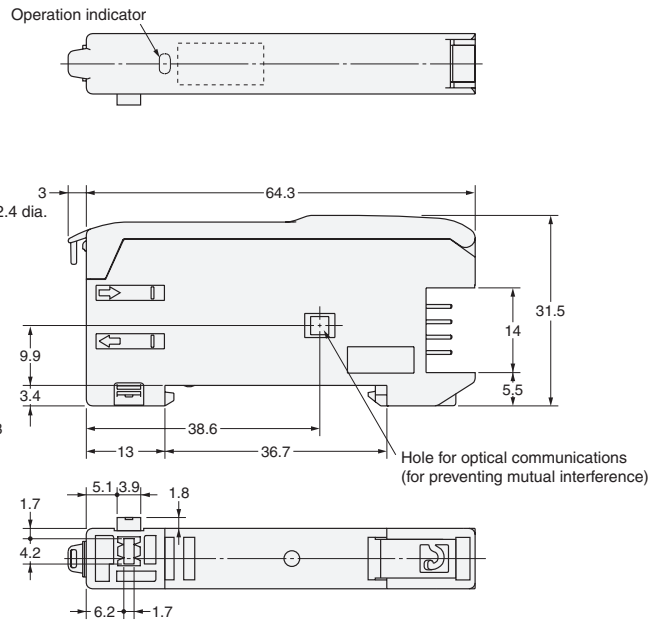

Amplifier Units with Cables,
Water-resistant Models

E3X-NA11V
E3X-NA41V

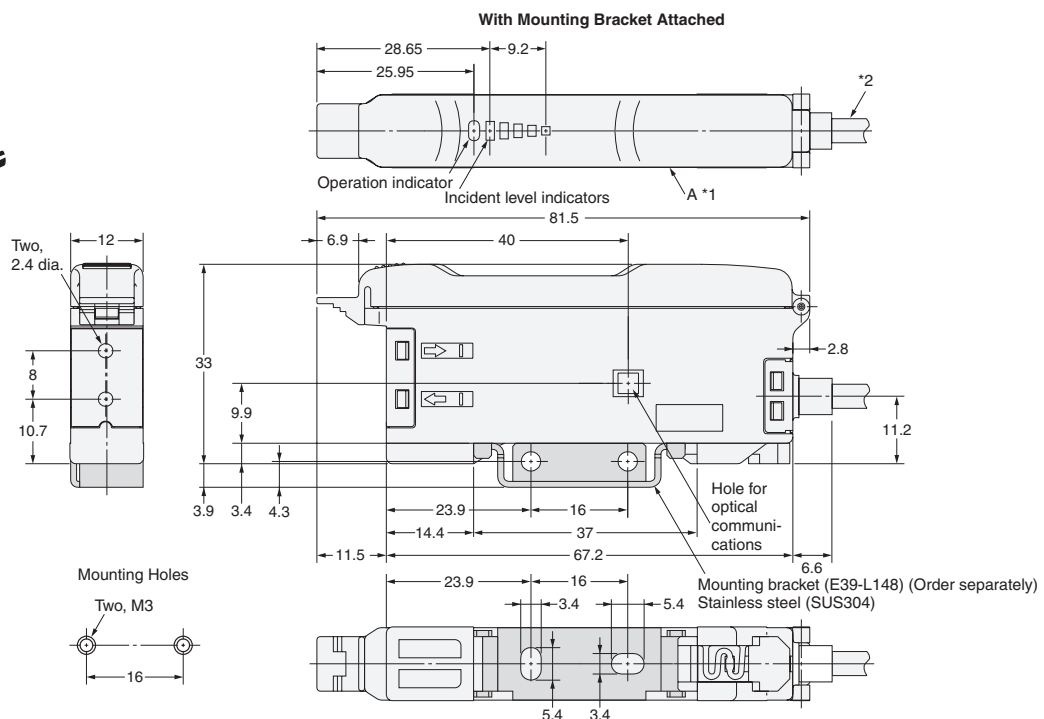
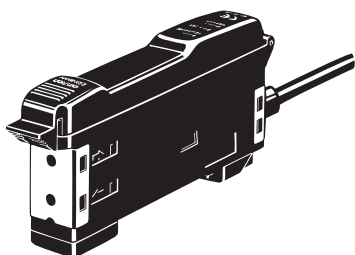

*1. The mounting bracket can also be used on side A.
*2. 4-dia. vinyl-insulated round cable with 3 conductors (Conductor cross section: 0.45 mm², Insulator diameter: 1.1 mm), Standard length: 2 m.

Amplifier Units with Connectors,
Water-resistant Models

E3X-NA14V
E3X-NA44V

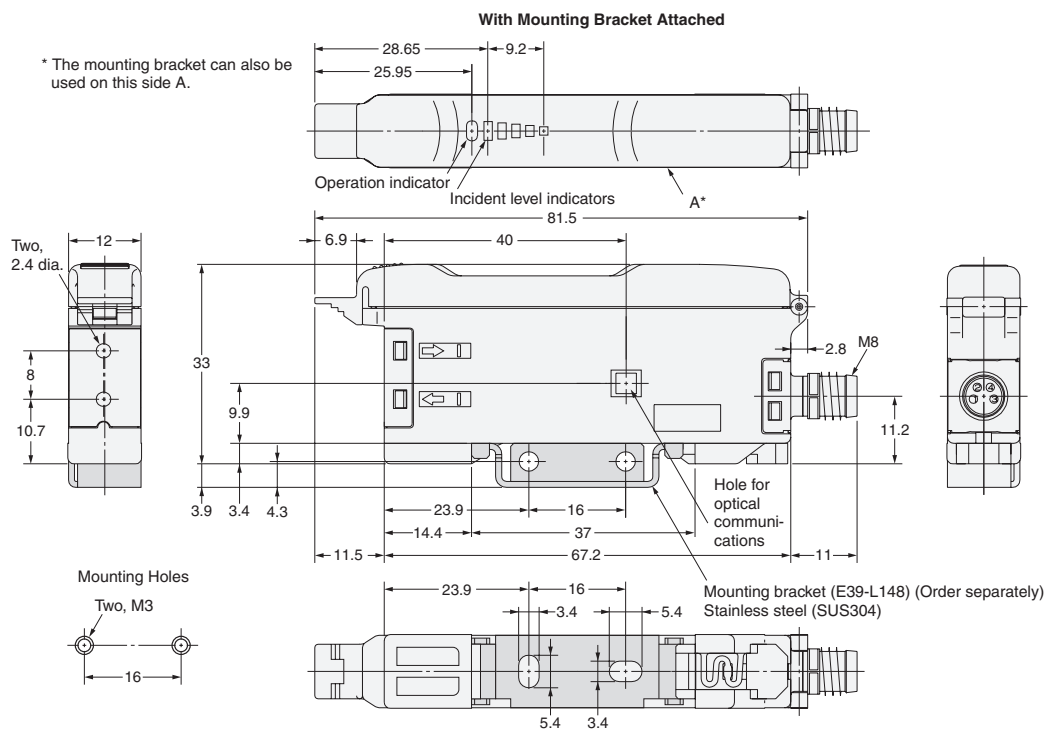
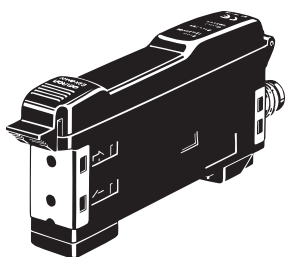

Dimensions (Unit: mm)

Amplifier Units with Cables

- E3X-DA11-S
- E3X-DA41-S
- E3X-DAC11-S
- E3X-DAC21-S
- E3X-DAC41-S
- E3X-DAC51-S
- E3X-DAG11-S
- E3X-DAG41-S
- E3X-DAB11-S
- E3X-DAB41-S
- E3X-DA11RM-S
- E3X-DA41RM-S
- E3X-DA11TW-S
- E3X-DA41TW-S
- E3X-MDA11
- E3X-MDA41

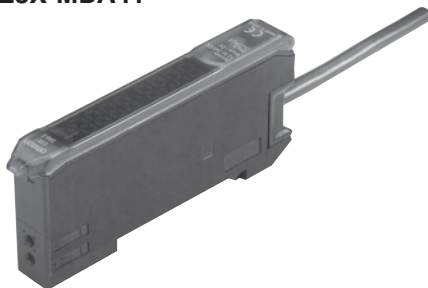
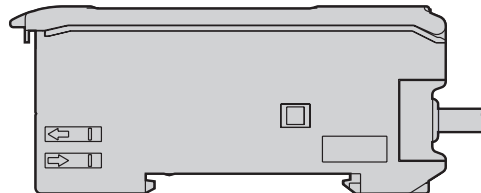
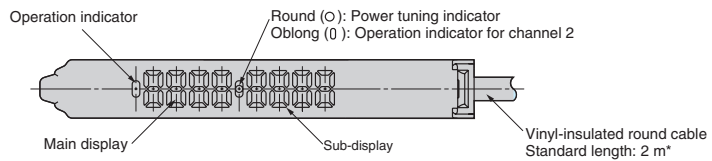

Cable Specifications

E3X-DA11-S/DA41-S/DAG11-S/ DAG41-S/DAB11-S/DAB41-S/ DAC11-S/DAC41-S	A 4-dia., 3-conductor (conductor cross-sectional area: 0.2 mm ² ; insulation diameter: 1.1 mm)
E3X-DA11TW-S/DA41TW-S/ DA11RM-S/DA41RM-S	A 4-dia., 4-conductor (conductor cross-sectional area: 0.2 mm ² ; insulation diameter: 1.1 mm)
E3X-MDA11/-MDA41	A 4-dia., 2-conductor (conductor cross-sectional area: 0.2 mm ² ; insulation diameter; 1.1 mm)
E3X-DAC21-S/-DAC51-S	A 4-dia., 5-conductor (conductor cross-sectional area: 0.2 mm ² ; insulation diameter; 1.1 mm)

With Mounting Bracket Attached

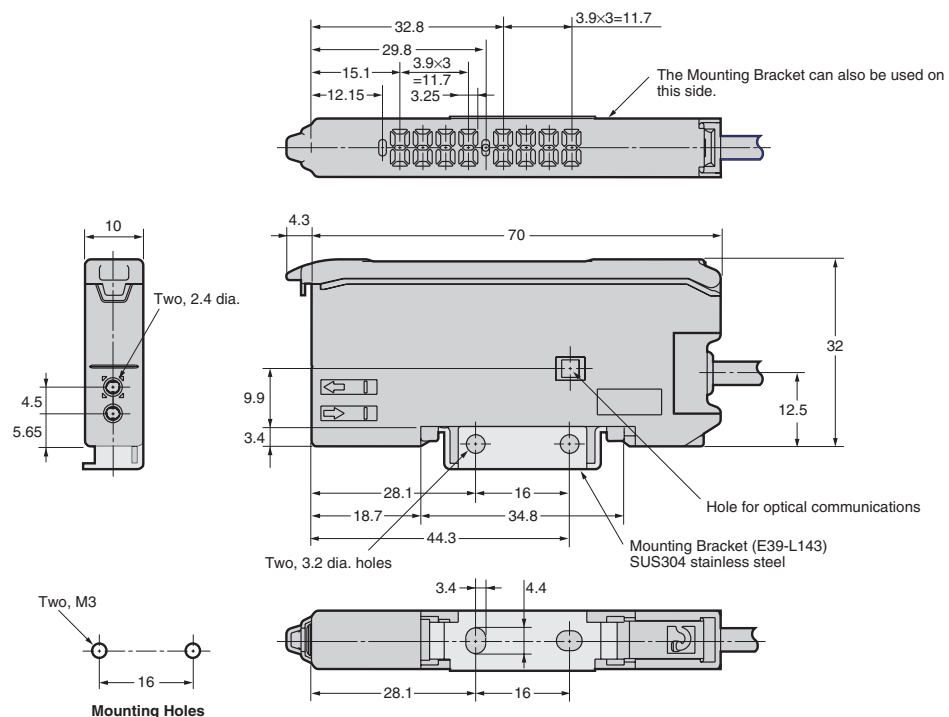

Amplifier Units with Connectors

- E3X-DA6-S
- E3X-DA8-S
- E3X-DAC6-S
- E3X-DAC8-S
- E3X-DAG6-S
- E3X-DAG8-S
- E3X-DAB6-S
- E3X-DAB8-S
- E3X-DA6RM-S
- E3X-DA8RM-S
- E3X-DA6TW-S
- E3X-DA8TW-S

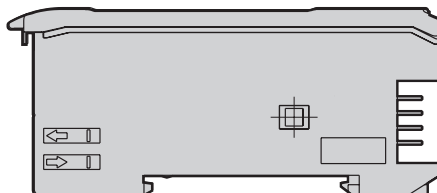
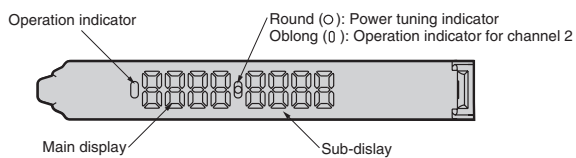

*1 The Mounting Bracket can also be used on this side.

*2 Cable Diameters

With Mounting Bracket Attached

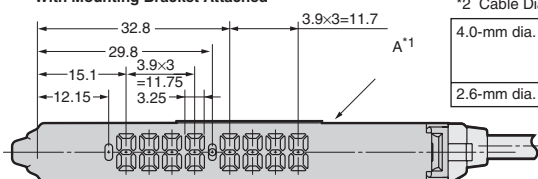

4.0-mm dia.	E3X-CN11 (3 conductors) E3X-CN21 (4 conductors) E3X-CN22 (2 conductors)
2.6-mm dia.	E3X-CN12 (1 conductor)

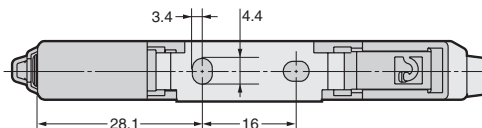
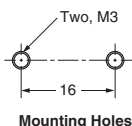
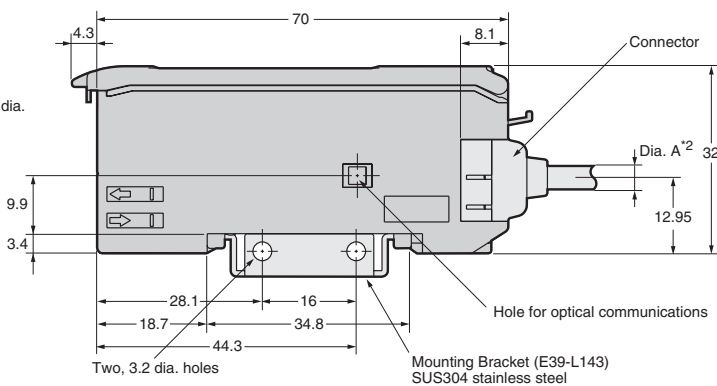
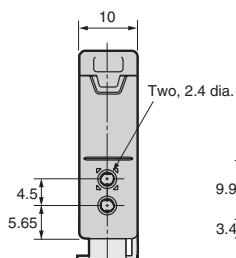

Dimensions (Unit: mm)

Master Connectors

E3X-CN11
E3X-CN21

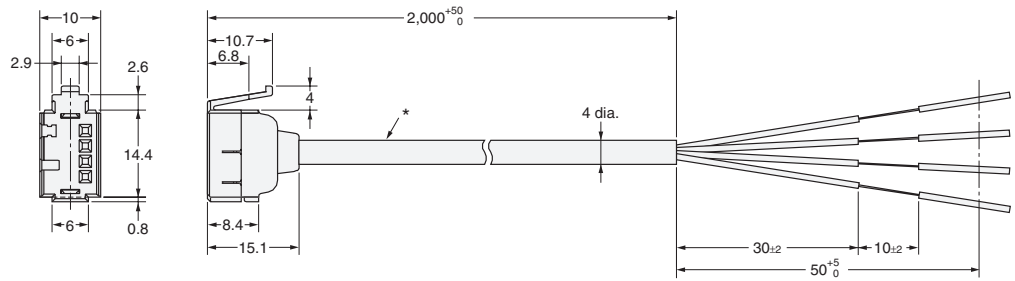
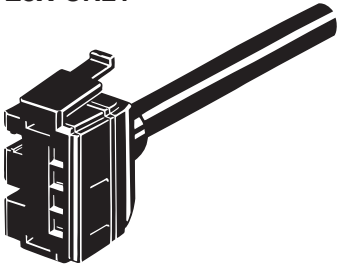

*E3C-CN11: A 4-dia., 3-conductor, vinyl-insulated round cable (conductor cross-sectional area: 0.2 mm²; insulation diameter: 1.1 mm) is used.
*E3C-CN21: A 4-dia., 4-conductor, vinyl-insulated round cable (conductor cross-sectional area: 0.2 mm²; insulation diameter: 1.1 mm) is used.

Slave Connectors

E3X-CN12
E3X-CN22

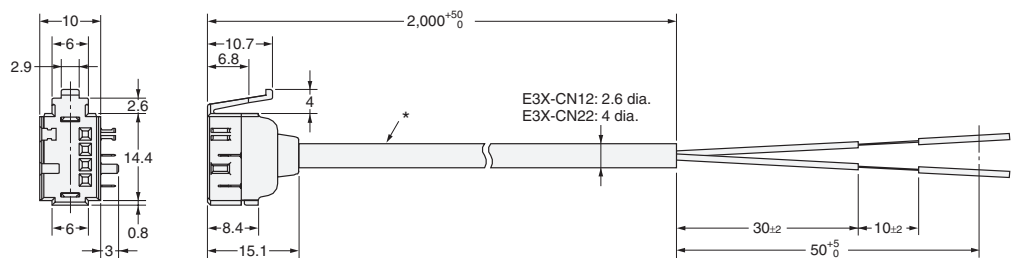
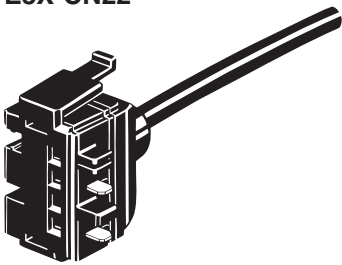

*E3C-CN12: A 2.6-dia., single-conductor, vinyl-insulated round cable (conductor cross-sectional area: 0.2 mm²; insulation diameter: 1.1 mm) is used.
*E3C-CN22: A 4-dia., 2-conductor, vinyl-insulated round cable (conductor cross-sectional area: 0.2 mm²; insulation diameter: 1.1 mm) is used.

Mounting Brackets

E39-L143

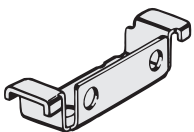

Material: Stainless steel (SUS304)

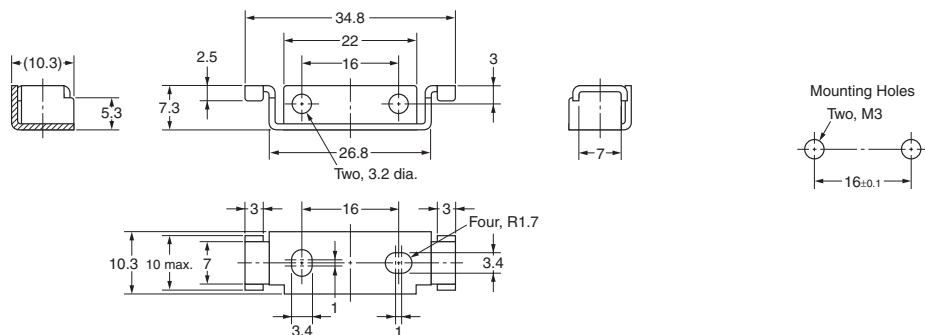

End Plates

PFP-M

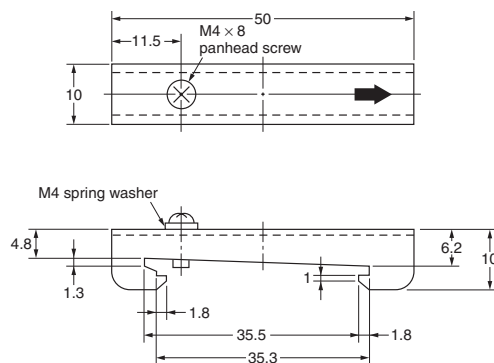
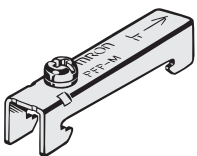

Mobile Console E3X-MC11-SV2

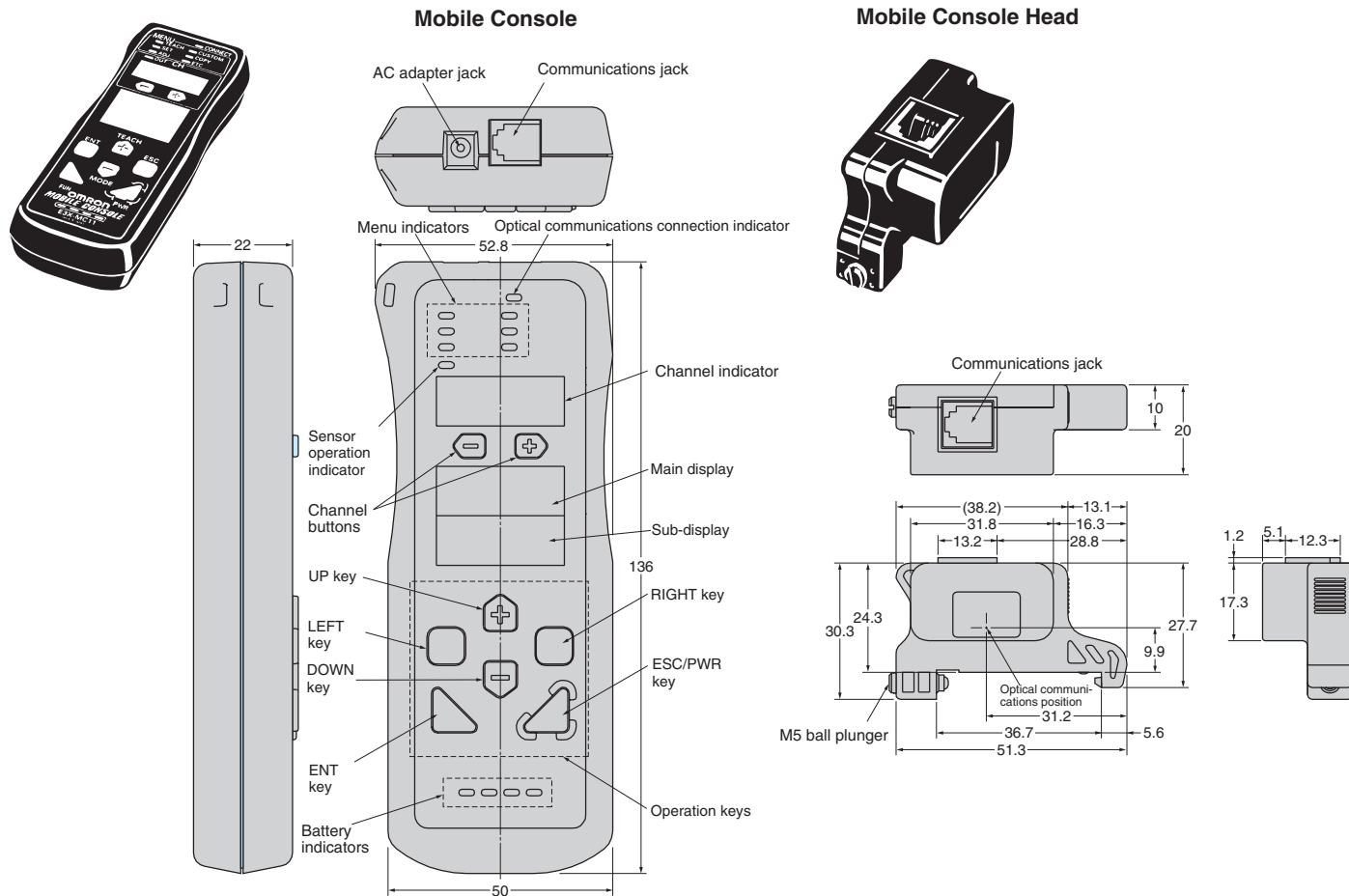

DeviceNet Communication Unit E3X-DRT21-S

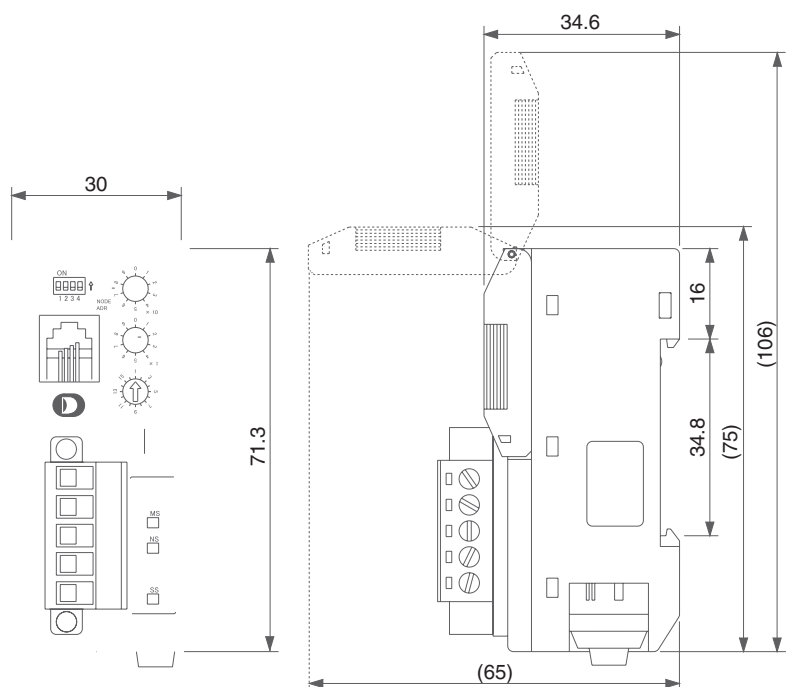



OMRON ELECTRONICS LLC • THE AMERICAS HEADQUARTERS

Schaumburg, IL USA • 847.843.7900 • 800.556.6766 • www.omron247.com

OMRON CANADA, INC. • HEAD OFFICE

Toronto, ON, Canada • 416.286.6465 • 866.986.6766 • www.omron.ca

OMRON ELETRÔNICA DO BRASIL LTDA • HEAD OFFICE

São Paulo, SP, Brasil • 55.11.2101.6300 • www.omron.com.br

OMRON ELECTRONICS MEXICO SA DE CV • HEAD OFFICE

Apodaca, N.L. • 52.811.156.99.10 • 001.800.556.6766 • mela@omron.com

OMRON ARGENTINA • SALES OFFICE

Cono Sur • 54.11.4783.5300

OMRON CHILE • SALES OFFICE

Santiago 56.9.9917.3920

OTHER OMRON LATIN AMERICA SALES

54.11.4783.5300