

Ultra Fast Recovery Rectifiers UFT30, 31 & 32

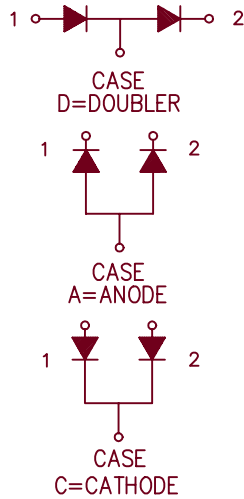
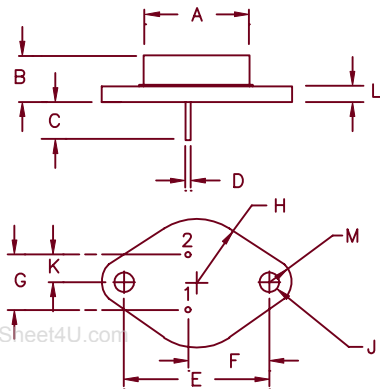

Dim.	Inches		Millimeter		Notes
	Minimum	Maximum	Minimum	Maximum	
A	—	.875	—	22.23	Dia.
B	.250	.450	6.35	11.43	
C	.312	—	7.92	—	
D	.038	.043	.97	1.09	Dia.
E	1.177	1.197	29.90	30.40	
F	.655	.675	16.64	17.15	
G	.420	.440	10.67	11.18	
H	—	.525	—	13.34	Rad.
J	.151	.161	3.84	4.09	Dia.
K	.205	.225	5.21	5.72	
L	—	.135	—	3.43	
M	—	.188	—	4.78	Rad.

TO-204AA (TO-3)

Microsemi Catalog Number	Working Peak Reverse Voltage	Peak Reverse Voltage
UFT3010*	100V	100V
UFT3015*	150V	150V
UFT3020*	200V	200V
UFT3130*	300V	300V
UFT3140*	400V	400V
UFT3150*	500V	500V
UFT3260*	600V	600V
UFT3270*	700V	700V
UFT3280*	800V	800V

*Add D, C or A

- Ultra Fast Recovery Rectifier
- 175°C Junction Temperature
- V_{RRM} 100 to 800V
- High Reliability
- 30 Amps current rating
- t_{RR} 35 to 60 nsec maximum

Electrical Characteristics Per Leg

	UFT30	UFT31	UFT32	
Average forward current	$I_F(AV)$ 30A	30A	30A	Square wave
Case Temperature (Standard)	T_C 138°C	124°C	122°C	$R_{\theta JC} = 1.4^\circ C/W$
Case Temperature (Reverse)	T_C 115°C	95°C	90°C	$R_{\theta JC} = 2.2^\circ C/W$
Maximum surge current	I_{FSM} 400A	350A	300A	8.3 ms, half sine, $T_J = 175^\circ C$
Max peak forward voltage	V_{FM} .93V	1.10V	1.20V	$I_{FM} = 15A; T_J = 25^\circ C^*$
Max reverse recovery time	t_{RR} 35 ns	50 ns	60 ns	1/2A, 1A, 1/4A, $T_J = 25^\circ C$
Typical reverse recovery time	t_{RR} 26 ns	36 ns	50 ns	1/2A, 1A, 1/4A, $T_J = 25^\circ C$
Max peak reverse current	I_{RM} —	1.0 mA	—	$V_{RRM}, T_J = 125^\circ C$
Max peak reverse current	I_{RM} —	15 μA	—	$V_{RRM}, T_J = 25^\circ C$
Typical Junction Capacitance	C_J 140 pF	115 pF	100 pF	$V_R = 10V, f = 1MHz, T_J = 25^\circ C$

*Pulse test: Pulse width 300 μsec , Duty cycle 2%

Thermal and Mechanical Characteristics

Storage temp range	T_{STG}	-65°C to 200°C
Operating junction temp range	T_J	-65°C to 175°C
Max thermal resistance (standard polarity)	$R_{\theta JC}$	1.4°C/W Junction to Case
Max thermal resistance (reverse polarity)	$R_{\theta JC}$	2.2°C/W Junction to Case
Typical thermal resistance (greased)	$R_{\theta CS}$	0.4°C/W Case to sink
Weight		1.0 ounces (28 grams) typical

UFT30

Figure 1
Typical Forward Characteristics – Per Leg

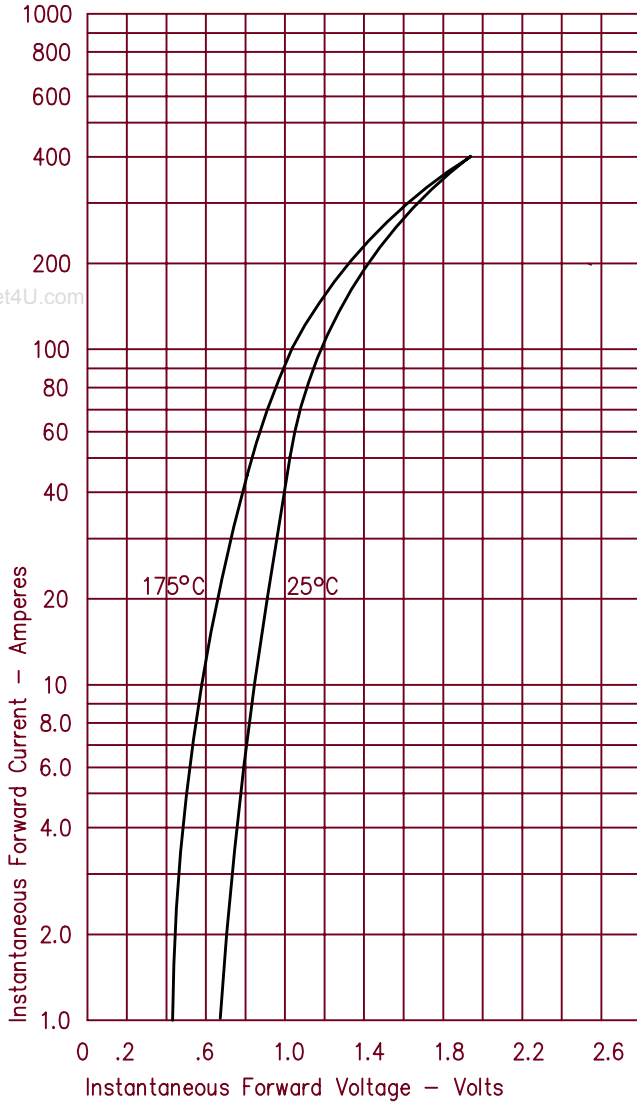

Figure 3
Typical Junction Capacitance – Per Leg

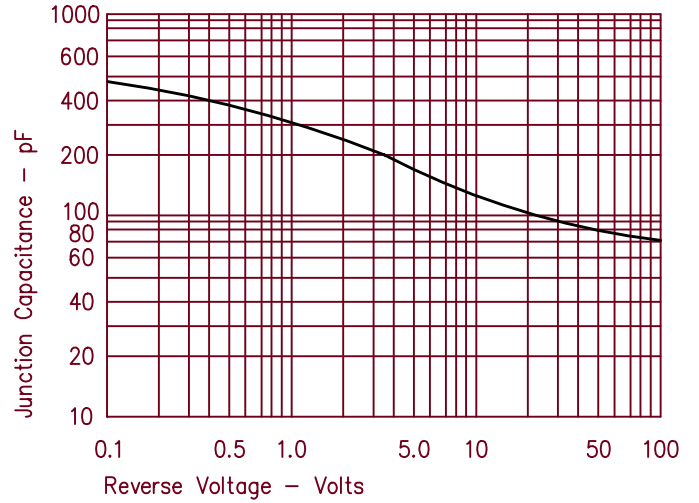

Figure 4
Forward Current Derating – Standard Polarity – Per Leg

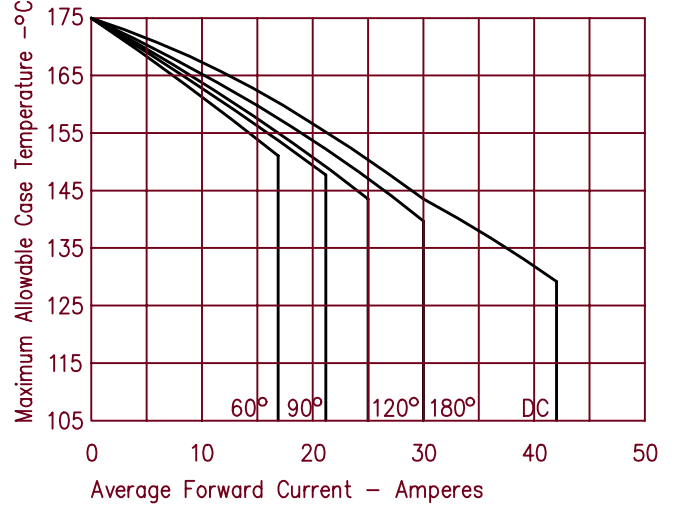

Figure 2
Typical Reverse Characteristics – Per Leg

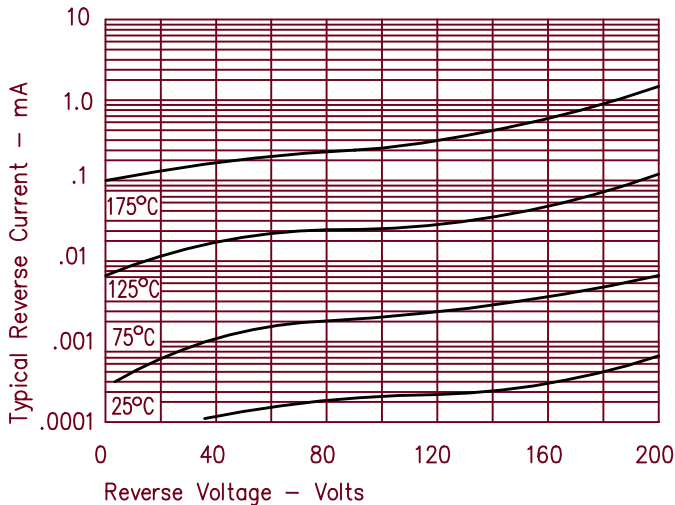
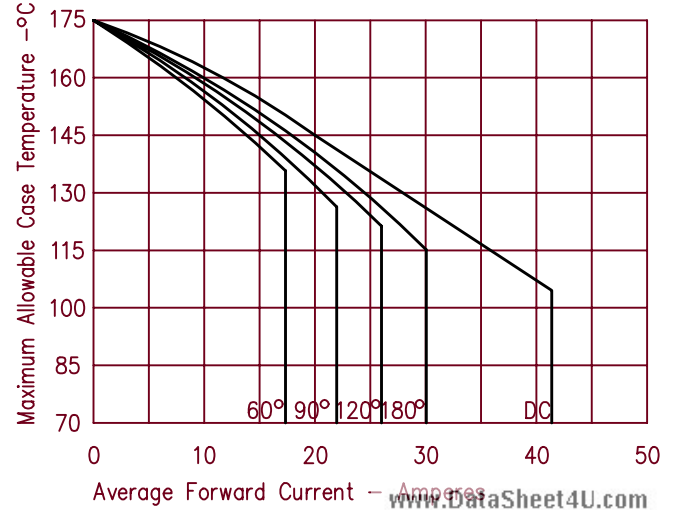

Figure 5
Forward Current Derating – Reverse Polarity – Per Leg



UFT30

Figure 6
Forward Current Derating – Standard Polarity – Per Leg

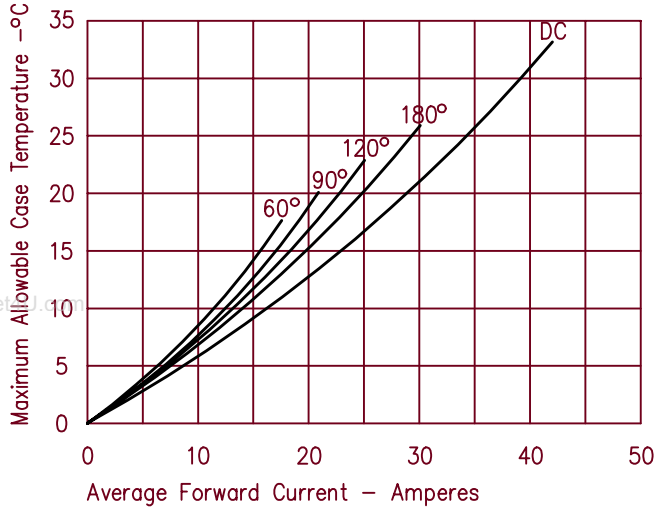
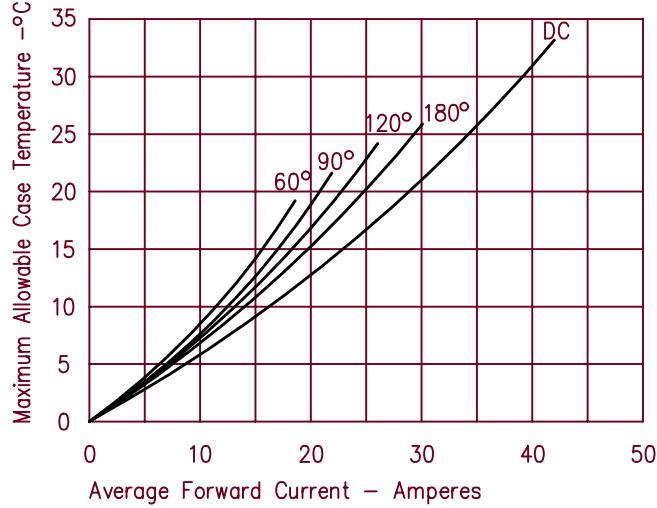

Figure 7
Forward Current Derating – Reverse Polarity – Per Leg



UFT31

Figure 1
Typical Forward Characteristics – Per Leg

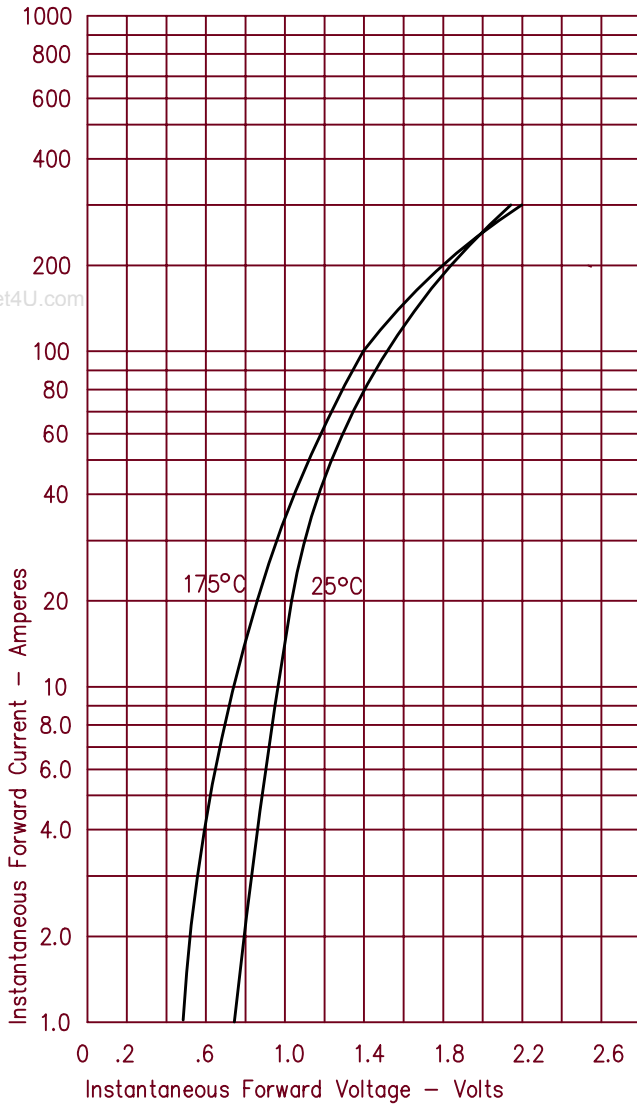

Figure 3
Typical Junction Capacitance – Per Leg

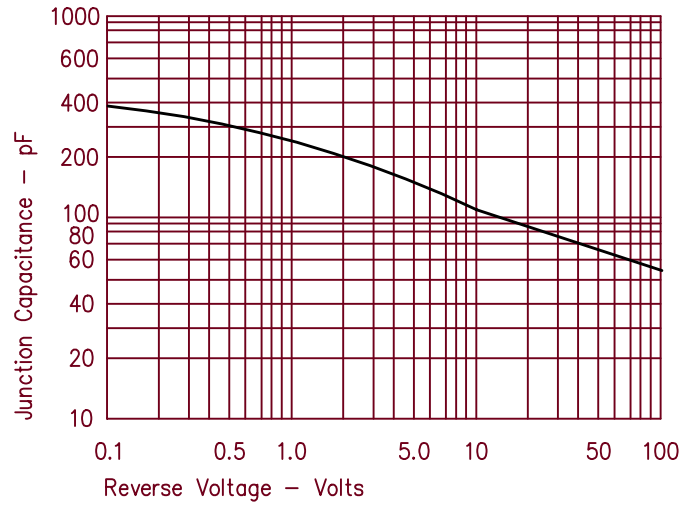

Figure 4
Forward Current Derating – Standard Polarity – Per Leg

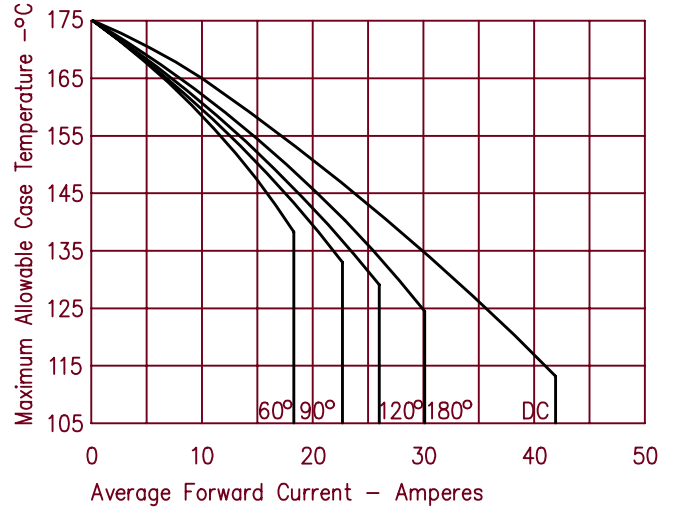

Figure 2
Typical Reverse Characteristics – Per Leg

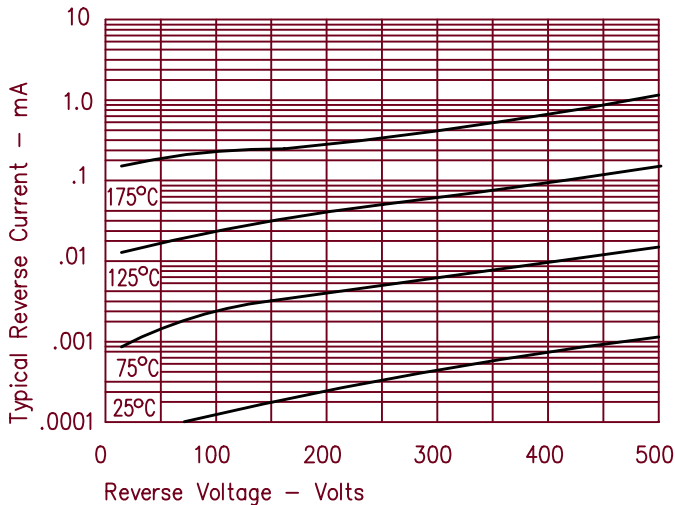
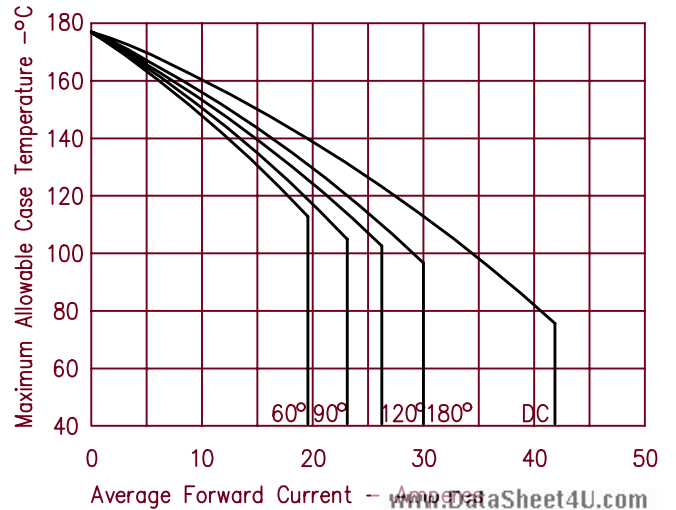

Figure 5
Forward Current Derating – Reverse Polarity – Per Leg



UFT32

Figure 1
Typical Forward Characteristics – Per Leg

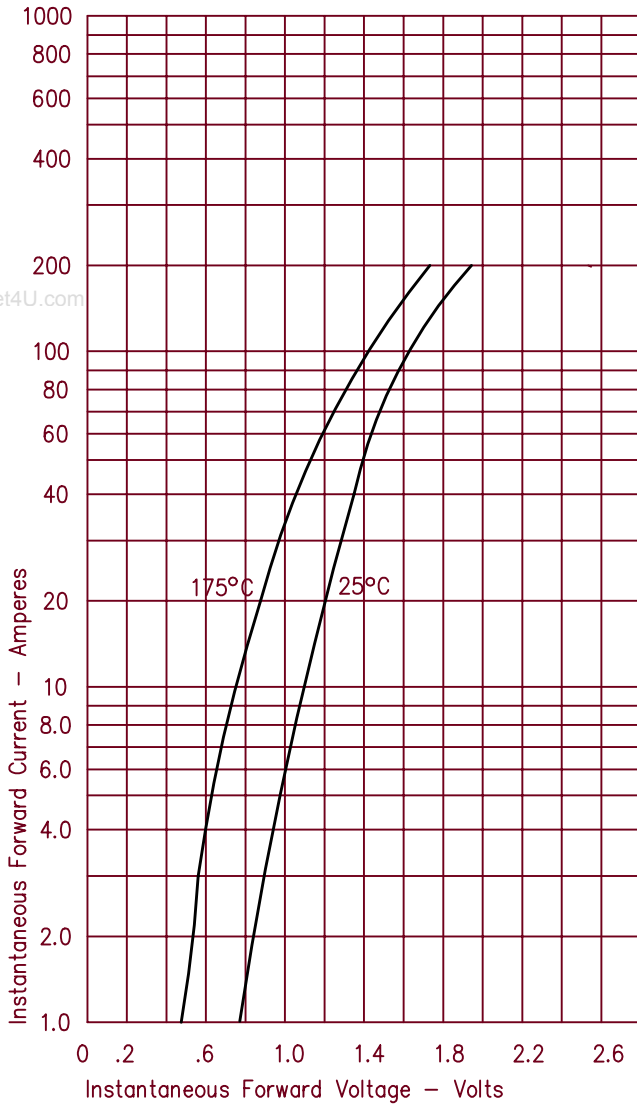

Figure 3
Typical Junction Capacitance

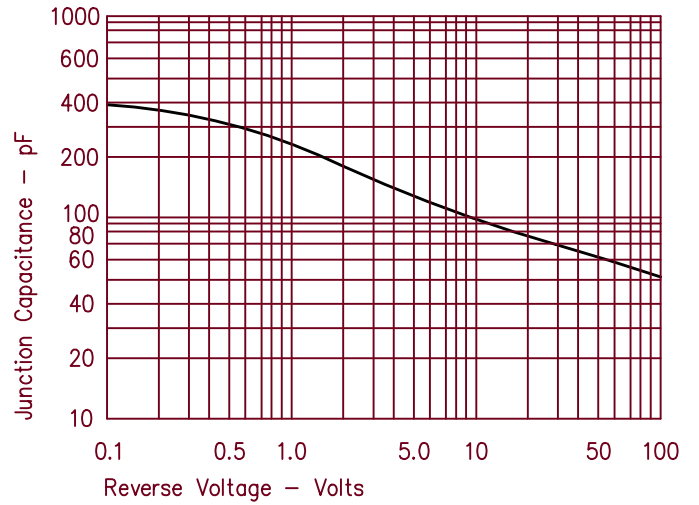

Figure 4
Forward Current Derating – Standard Polarity – Per Leg

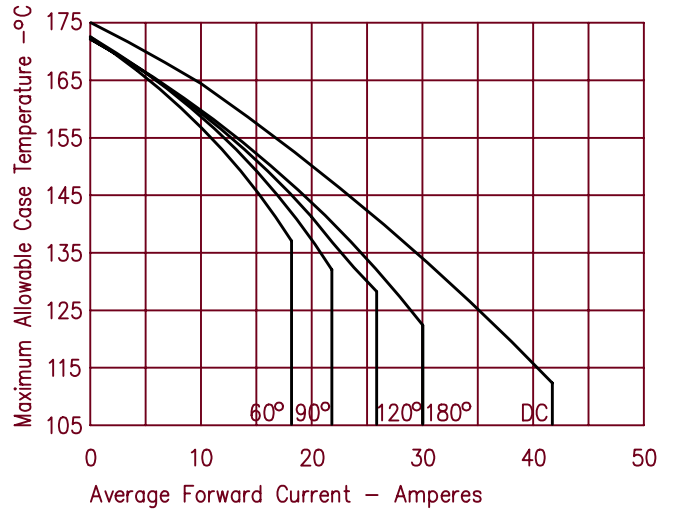

Figure 2
Typical Reverse Characteristics – Per Leg

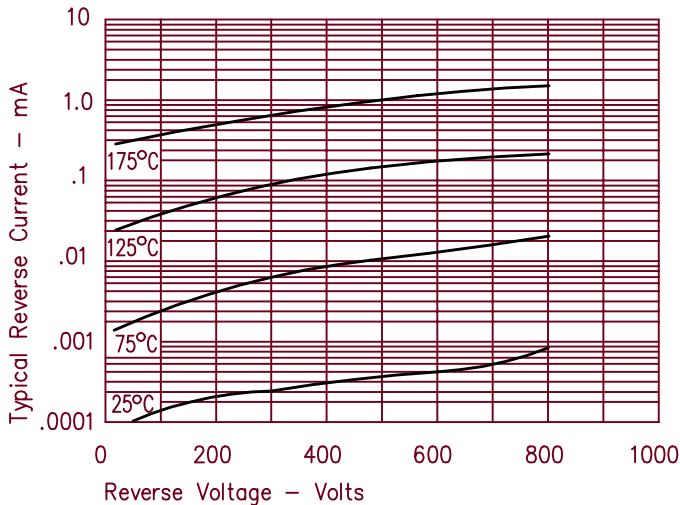
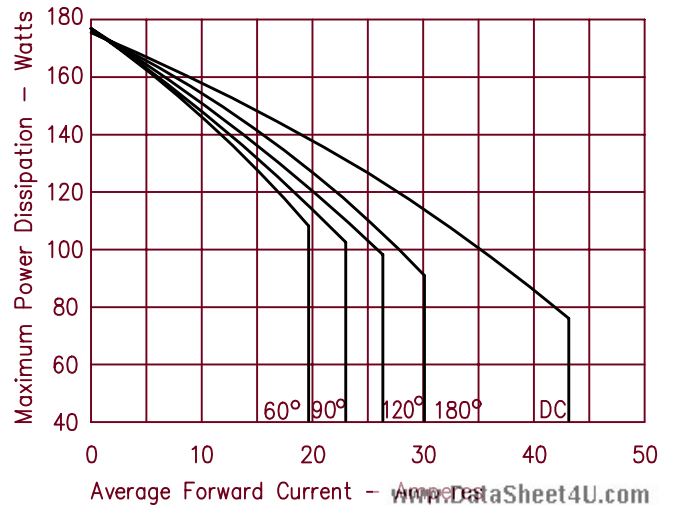

Figure 5
Forward Current Derating – Reverse Polarity – Per Leg



UFT32

Figure 6
Forward Current Derating – Standard Polarity – Per Leg

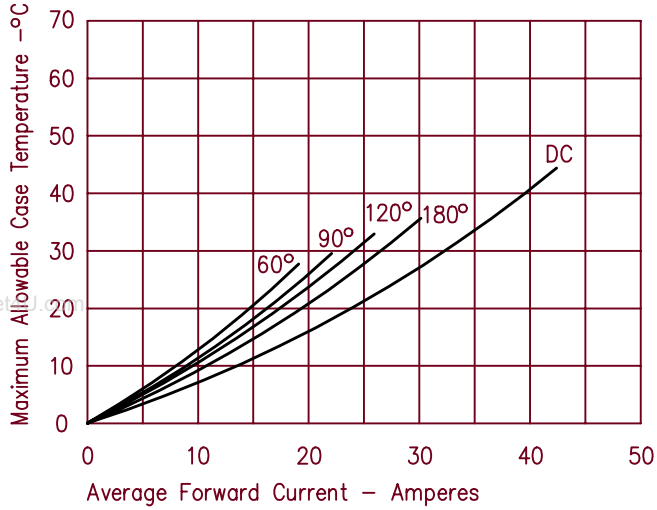

Figure 7
Forward Current Derating – Reverse Polarity – Per Leg

