

## MT2303-BG

### Features

High Intensity  
 Reliable Rugged  
 Low Current Requirements  
 IC Compatible

### Maximum Ratings (Ta=25°C)

Characteristic	Symbol	Max.	Unit
Forward Current	I <sub>F</sub>	20	mA
Reverse Voltage	V <sub>R</sub>	5	V
Power Dissipation	P <sub>D</sub>	80.00	mW
Operating Temperature	T <sub>opr</sub>	-25 ~ +85	°C
Storage Temperature	T <sub>stg</sub>	-40 ~ +100	°C
Soldering Temperature	T <sub>sol</sub>	260	°C
Soldering Time	-	for 5 sec. max	-

### Opto-Electrical Characteristics (Ta=25°C)

Characteristic	Symbol	Test Condition	Min	Typ	Max	Unit
Forward Voltage	V <sub>F</sub>	I <sub>F</sub> =20mA	-	3.20	4.00	V
Reverse Current	I <sub>R</sub>	V <sub>R</sub> =5V	-	-	50	μ A
Luminous Intensity	I <sub>v</sub>	I <sub>F</sub> =20mA	2000.00	3400.00	-	mcd
Viewing Angle	2θ <sup>1/2</sup>	-	-	36°	-	deg.
Peak Wavelength	λ <sub>p</sub>	I <sub>F</sub> =20mA	-	502	-	nm
Dominant Wavelength	λ <sub>d</sub>	I <sub>F</sub> =20mA	-	505	-	nm
Spectral Line Half Width	Δλ	I <sub>F</sub> =20mA	-	38	-	nm

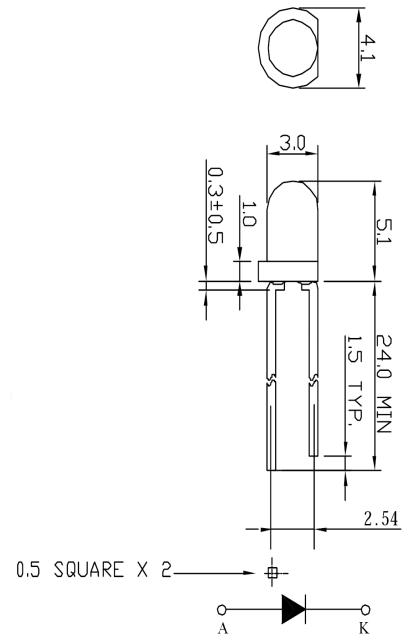

Notes:

1. All dimensions are in millimeters.
2. Tolerance is ±0.25mm unless otherwise noted.

## MT2303-BG Graphs

### Typical Electrical / Optical Characteristics Curves :

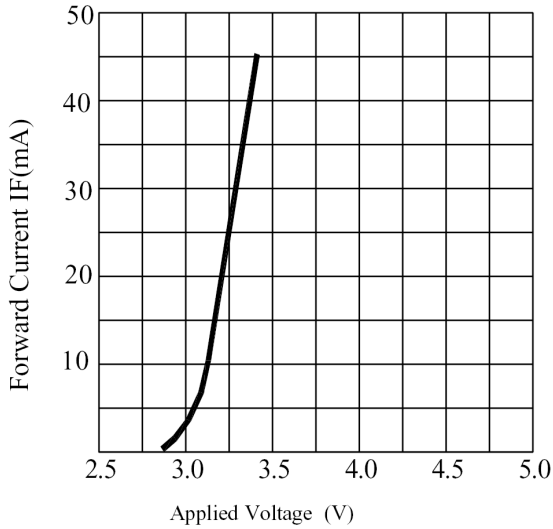

**FORWARD CURRENT VS. APPLIED VOLTAGE**

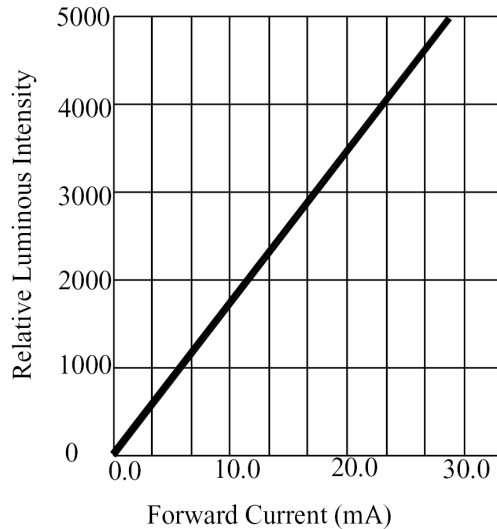

**FORWARD CURRENT VS. LUMINOUS INTENSITY**

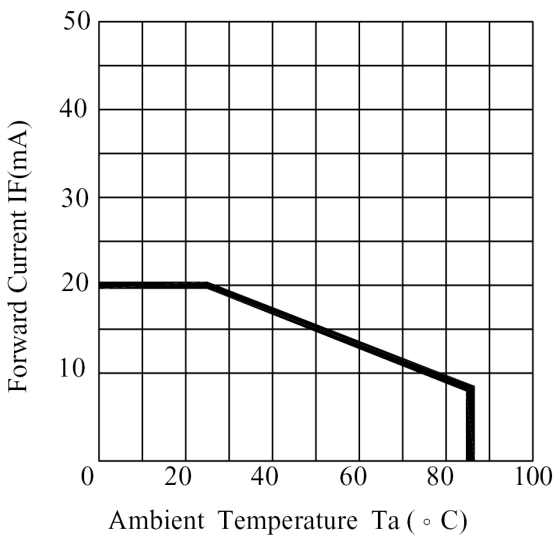

**AMBIENT TEMPERATURE VS. FORWARD CURRENT**

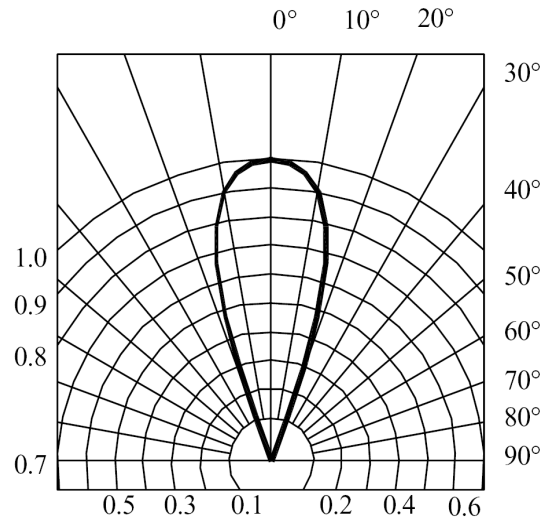

**RADIATION DIAGRAM**