

Logic N-Channel MOSFET

Features

- Low $R_{DS(on)}$ (0.0085Ω)@ $V_{GS}=10V$
- Low Gate Charge (Typical 39nC)
- Low C_{rss} (Typical 185pF)
- Improved dv/dt Capability
- 100% Avalanche Tested
- Maximum Junction Temperature Range (175°C)

General Description

This Power MOSFET is produced using SemiWell's advanced planar stripe, DMOS technology. This latest technology has been especially designed to minimize on-state resistance, have a low gate charge with superior switching performance, and rugged avalanche characteristics. This Power MOSFET is well suited for synchronous DC-DC Converters and Power Management in portable and battery operated products.

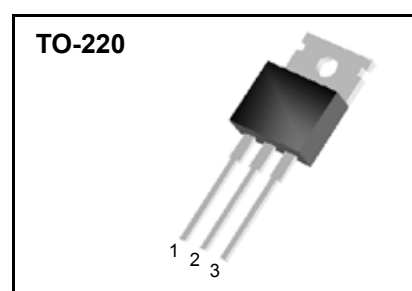
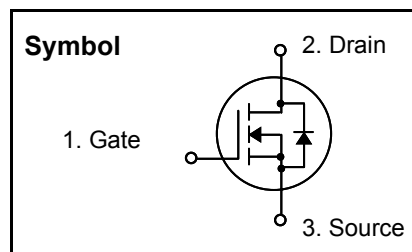

Absolute Maximum Ratings

Symbol	Parameter	Value	Units
V_{DSS}	Drain to Source Voltage	30	V
I_D	Continuous Drain Current(@ $T_C = 25^\circ C$) (Note 6)	95	A
	Continuous Drain Current(@ $T_C = 100^\circ C$)	67.3	A
I_{DM}	Drain Current Pulsed (Note 1)	380	A
V_{GS}	Gate to Source Voltage	± 20	V
E_{AS}	Single Pulsed Avalanche Energy (Note 2)	450	mJ
dv/dt	Peak Diode Recovery dv/dt (Note 3)	7.0	V/ns
P_D	Total Power Dissipation(@ $T_C = 25^\circ C$)	150	W
	Derating Factor above $25^\circ C$	1.0	W/ $^\circ C$
T_{STG}, T_J	Operating Junction Temperature & Storage Temperature	- 55 ~ 175	$^\circ C$
T_L	Maximum Lead Temperature for soldering purpose, 1/8 from Case for 5 seconds.	300	$^\circ C$

Thermal Characteristics

Symbol	Parameter	Value			Units
		Min.	Typ.	Max.	
$R_{\theta JC}$	Thermal Resistance, Junction-to-Case	-	-	1.0	$^\circ C/W$
$R_{\theta CS}$	Thermal Resistance, Case to Sink	-	0.5	-	$^\circ C/W$
$R_{\theta JA}$	Thermal Resistance, Junction-to-Ambient	-	-	62.5	$^\circ C/W$

SFP95N03L

Electrical Characteristics (T_C = 25 °C unless otherwise noted)

Symbol	Parameter	Test Conditions	Min	Typ	Max	Units
Off Characteristics						
BV _{DSS}	Drain-Source Breakdown Voltage	V _{GS} = 0V, I _D = 250uA	30	-	-	V
$\frac{\Delta BV_{DSS}}{\Delta T_J}$	Breakdown Voltage Temperature coefficient	I _D = 250uA, referenced to 25 °C	-	0.023	-	V/°C
I _{DSS}	Drain-Source Leakage Current	V _{DS} = 30V, V _{GS} = 0V	-	-	1	uA
		V _{DS} = 24V, T _C = 150 °C	-	-	10	uA
I _{GSS}	Gate-Source Leakage, Forward	V _{GS} = 20V, V _{DS} = 0V	-	-	100	nA
	Gate-Source Leakage, Reverse	V _{GS} = -20V, V _{DS} = 0V	-	-	-100	nA
On Characteristics						
V _{GS(th)}	Gate Threshold Voltage	V _{DS} = V _{GS} , I _D = 250uA	1.0	-	3.0	V
R _{DS(ON)}	Static Drain-Source On-state Resistance	V _{GS} = 10 V, I _D = 47.5A V _{GS} = 5 V, I _D = 47.5A	-	0.0065 0.0085	0.0085 0.0115	Ω
Dynamic Characteristics						
C _{iss}	Input Capacitance	V _{GS} = 0 V, V _{DS} = 25V, f = 1MHz	-	1015	1320	pF
C _{OSS}	Output Capacitance		-	845	1110	
C _{rss}	Reverse Transfer Capacitance		-	185	240	
Dynamic Characteristics						
t _{d(on)}	Turn-on Delay Time	V _{DD} = 15V, I _D = 95A, R _G = 50Ω * see fig. 13. (Note 4, 5)	-	45	100	ns
t _r	Rise Time		-	165	340	
t _{d(off)}	Turn-off Delay Time		-	70	150	
t _f	Fall Time		-	140	290	
Q _g	Total Gate Charge	V _{DS} = 24V, V _{GS} = 5V, I _D = 95A * see fig. 12. (Note 4, 5)	-	39	51	nC
Q _{gs}	Gate-Source Charge		-	13	-	
Q _{gd}	Gate-Drain Charge(Miller Charge)		-	18	-	

Source-Drain Diode Ratings and Characteristics

Symbol	Parameter	Test Conditions	Min.	Typ.	Max.	Unit.
I _S	Continuous Source Current	Integral Reverse p-n Junction Diode in the MOSFET	-	-	95	A
I _{SM}	Pulsed source Current		-	-	380	
V _{SD}	Diode Forward Voltage	I _S = 95A, V _{GS} = 0V	-	-	1.5	V
t _{rr}	Reverse Recovery Time	I _S = 95A, V _{GS} = 0V, dI _F /dt = 100A/us	-	55	-	ns
Q _{rr}	Reverse Recovery Charge		-	65	-	nC

* NOTES

1. Repeatability rating : pulse width limited by junction temperature
2. L = 50 uH, I_{AS} = 95A, V_{DD} = 15V, R_G = 0Ω, Starting T_J = 25°C
3. I_{SD} ≤ 95A, di/dt ≤ 300A/us, V_{DD} ≤ BV_{DSS}, Starting T_J = 25°C
4. Pulse Test : Pulse Width ≤ 300us, Duty Cycle ≤ 2%
5. Essentially independent of operating temperature.
6. Continuous Drain current calculated by maximum junction temperature ; limited by package



Fig 1. On-State Characteristics

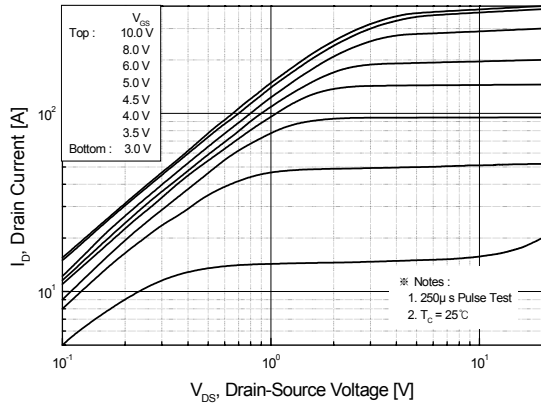

Fig 2. Transfer Characteristics

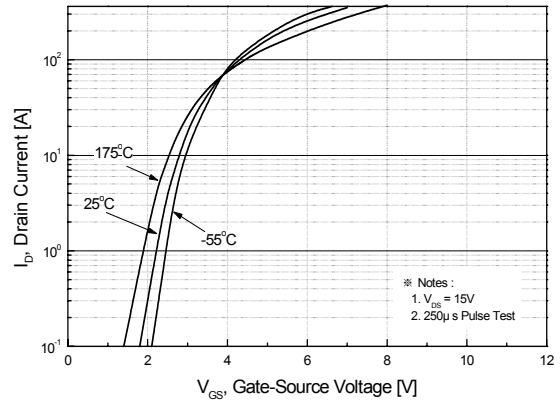

Fig 3. On Resistance Variation vs. Drain Current and Gate Voltage

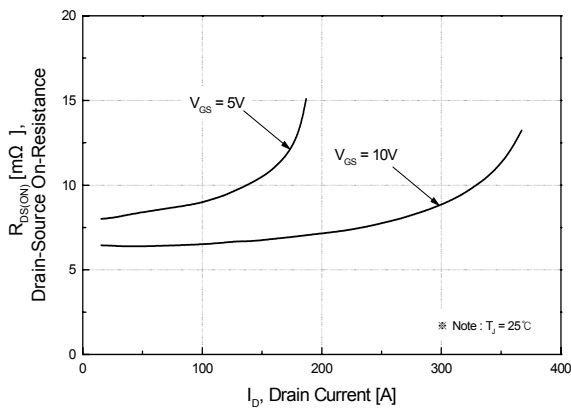

Fig 4. On State Current vs. Allowable Case Temperature

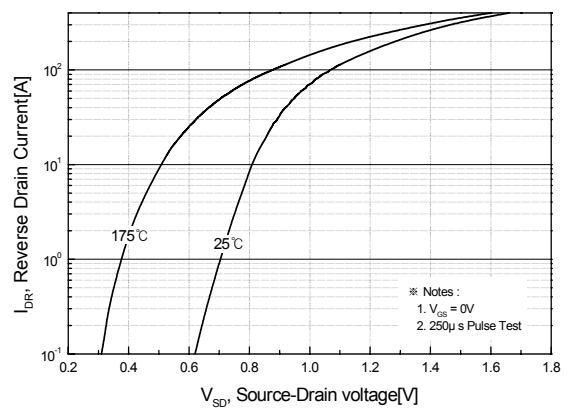

Fig 5. Capacitance Characteristics

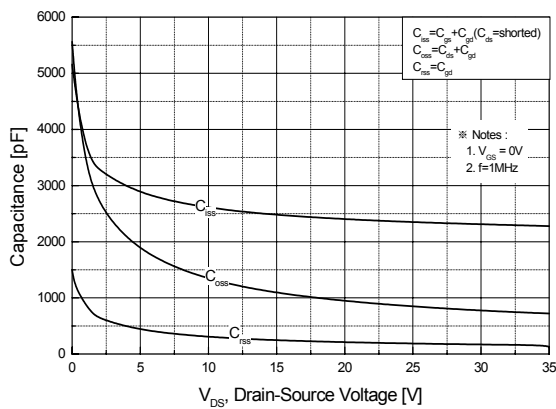
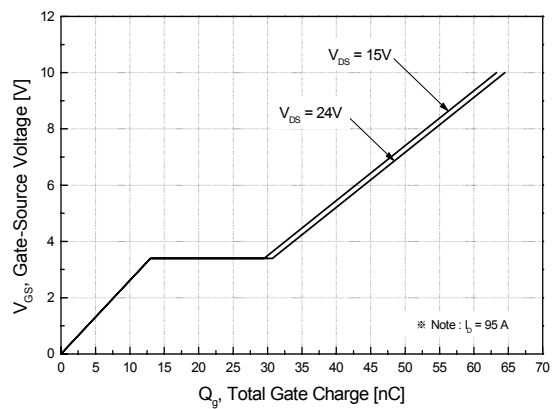

Fig 6. Gate Charge Characteristics



SFP95N03L

Fig 7. Breakdown Voltage Variation

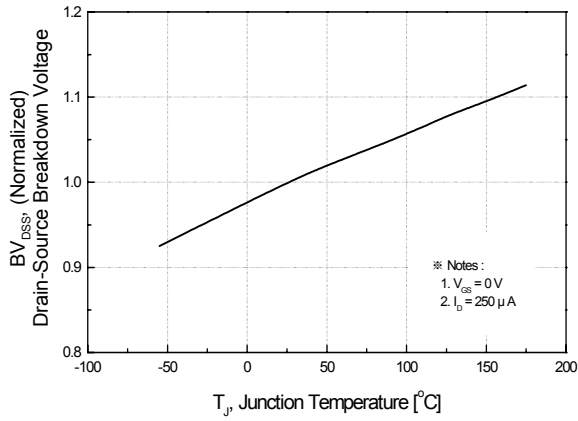

Fig 8. On-Resistance Variation

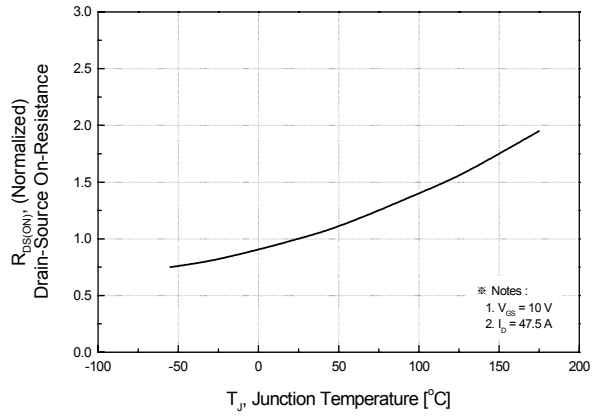

Fig 9. Maximum Safe Operating Area

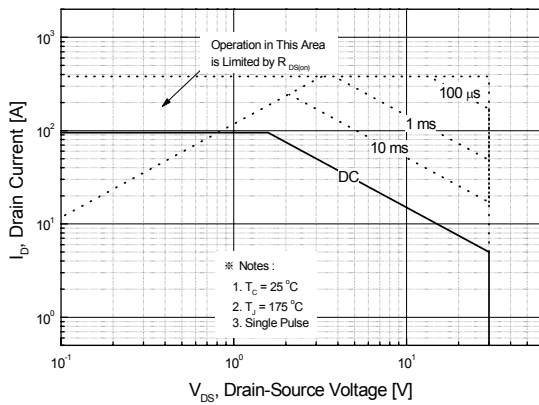

Fig 10. Maximum Drain Current vs. Case Temperature

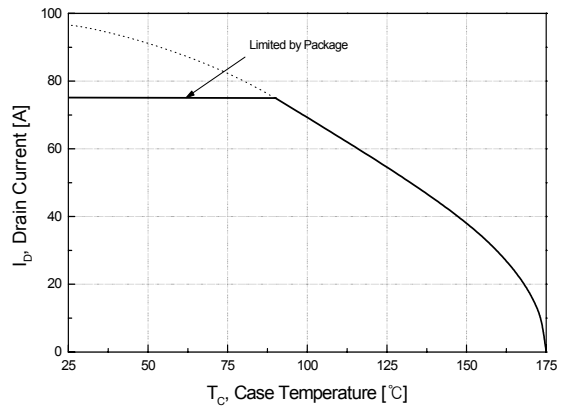

Fig 11. Transient Thermal Response Curve

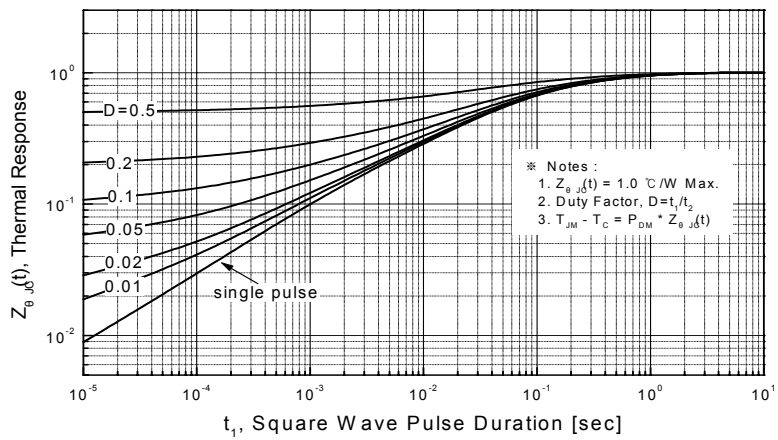

Fig. 12. Gate Charge Test Circuit & Waveforms

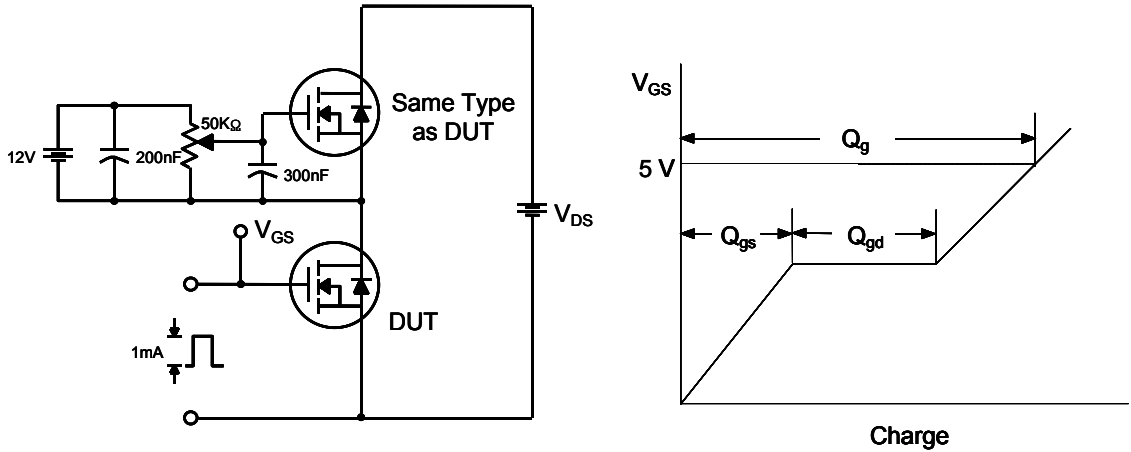

Fig. 13. Switching Time Test Circuit & Waveforms

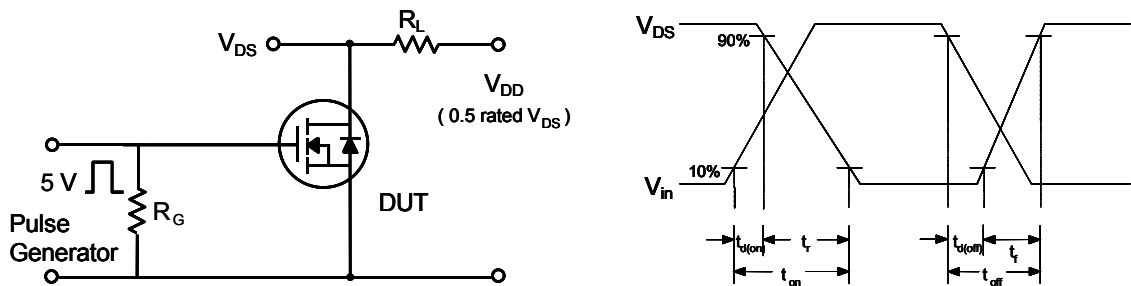
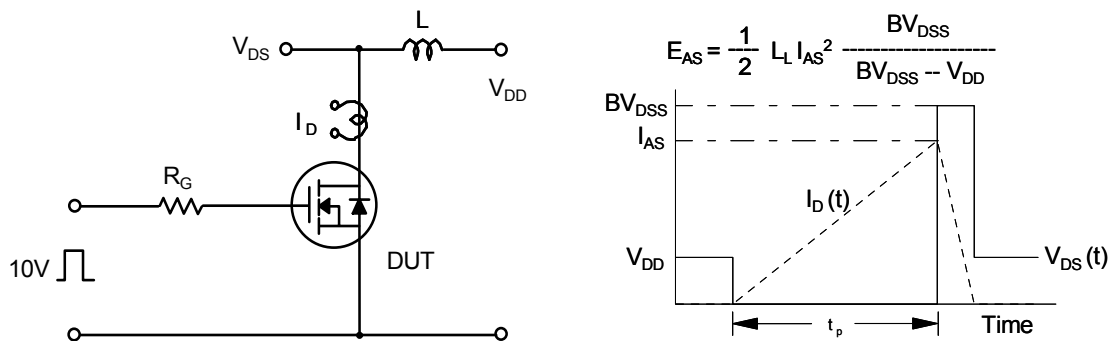

Fig. 14. Unclamped Inductive Switching Test Circuit & Waveforms



SFP95N03L

TO-220 Package Dimension

Dim.	mm			Inch		
	Min.	Typ.	Max.	Min.	Typ.	Max.
A	9.7		10.1	0.382		0.398
B	6.3		6.7	0.248		0.264
C	9.0		9.47	0.354		0.373
D	12.8		13.3	0.504		0.524
E	1.2		1.4	0.047		0.055
F		1.7			0.067	
G		2.5			0.098	
H	3.0		3.4	0.118		0.134
I	1.25		1.4	0.049		0.055
J	2.4		2.7	0.094		0.106
K	5.0		5.15	0.197		0.203
L	2.2		2.6	0.087		0.102
M	1.42		1.62	0.056		0.064
N	0.45		0.6	0.018		0.024
O	1.17		1.37	0.046		0.054
ϕ		3.6			0.142	

