

**PowerMOS transistor  
Logic level TOPFET**

**BUK102-50GL**

**DESCRIPTION**

Monolithic temperature and overload protected logic level power MOSFET in a 3 pin plastic envelope, intended as a general purpose switch for automotive systems and other applications.

**APPLICATIONS**

- General controller for driving
- lamps
  - motors
  - solenoids
  - heaters

**FEATURES**

- Vertical power DMOS output stage
- Low on-state resistance
- Overload protection against over temperature
- Overload protection against short circuit load
- Latched overload protection reset by input
- 5 V input level
- Low threshold voltage also allows 5 V control
- Control of power MOSFET and supply of overload protection circuits derived from input
- ESD protection on input pin
- Overvoltage clamping for turn off of inductive loads

**QUICK REFERENCE DATA**

| SYMBOL       | PARAMETER   | MAX. | UNIT |
|--------------|---|------|------|
| $V_{DS}$     | Continuous drain source voltage                           | 50   | V    |
| $I_D$        | Continuous drain current                                  | 45   | A    |
| $P_D$        | Total power dissipation                                   | 125  | W    |
| $T_j$        | Continuous junction temperature                           | 150  | °C   |
| $R_{DS(ON)}$ | Drain-source on-state resistance<br>$V_{IS} = 5\text{ V}$ | 35   | mΩ   |

**FUNCTIONAL BLOCK DIAGRAM**

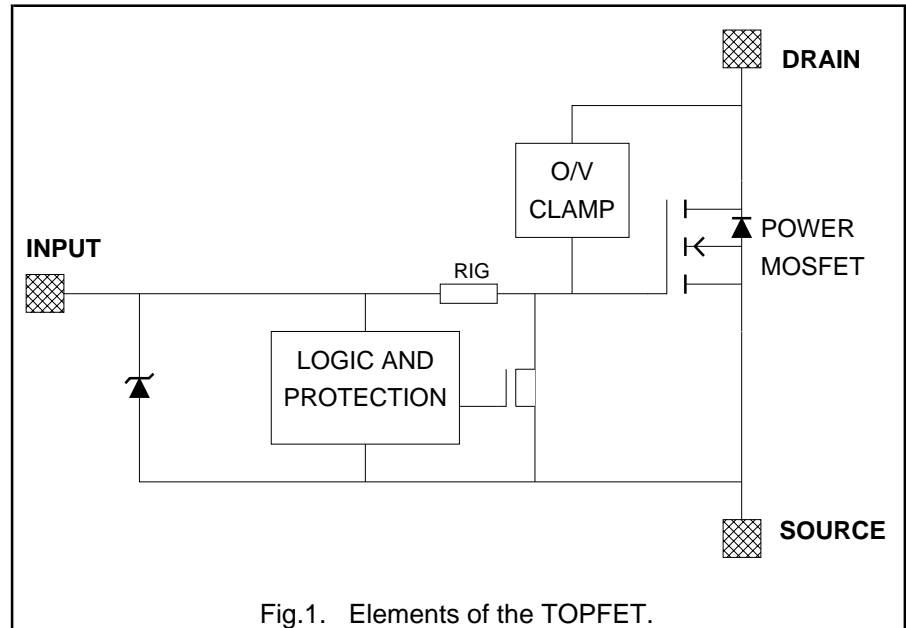

**PINNING - TO220AB**

| PIN | DESCRIPTION |
|-----|-------------|
| 1   | input       |
| 2   | drain       |
| 3   | source      |
| tab | drain       |

**PIN CONFIGURATION**

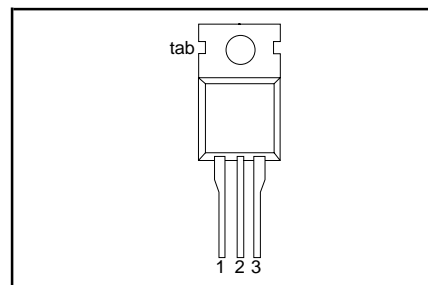

**SYMBOL**

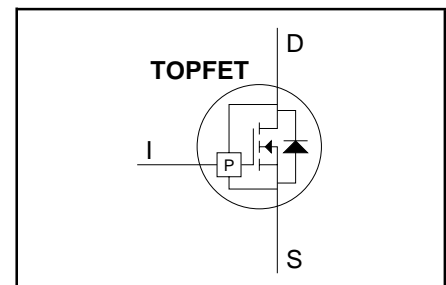

# PowerMOS transistor

## Logic level TOPFET

BUK102-50GL

### LIMITING VALUES

Limiting values in accordance with the Absolute Maximum Rating System (IEC 134)

| SYMBOL     | PARAMETER  | CONDITIONS   | MIN. | MAX. | UNIT             |
|------------|--|--|------|------|------------------|
| $V_{DSS}$  | Continuous off-state drain source voltage <sup>1</sup> | $V_{IS} = 0 \text{ V}$   | -    | 50   | V                |
| $V_{IS}$   | Continuous input voltage                               | -  | 0    | 6    | V                |
| $I_D$      | Continuous drain current                               | $T_{mb} \leq 25 \text{ }^\circ\text{C}; V_{IS} = 5 \text{ V}$  | -    | 45   | A                |
| $I_D$      | Continuous drain current                               | $T_{mb} \leq 100 \text{ }^\circ\text{C}; V_{IS} = 5 \text{ V}$ | -    | 28   | A                |
| $I_{DRM}$  | Repetitive peak on-state drain current                 | $T_{mb} \leq 25 \text{ }^\circ\text{C}; V_{IS} = 5 \text{ V}$  | -    | 180  | A                |
| $P_D$      | Total power dissipation                                | $T_{mb} \leq 25 \text{ }^\circ\text{C}$                        | -    | 125  | W                |
| $T_{stg}$  | Storage temperature                                    | -  | -55  | 150  | $^\circ\text{C}$ |
| $T_j$      | Continuous junction temperature <sup>2</sup>           | normal operation   | -    | 150  | $^\circ\text{C}$ |
| $T_{sold}$ | Lead temperature                                       | during soldering   | -    | 250  | $^\circ\text{C}$ |

### OVERLOAD PROTECTION LIMITING VALUES

With the protection supply provided via the input pin, TOPFET can protect itself from two types of overload.

| SYMBOL       | PARAMETER  | CONDITIONS                           | MIN. | MAX. | UNIT |
|--------------|--|--------------------------------------|------|------|------|
| $V_{ISP}$    | Protection supply voltage <sup>3</sup>             | for valid protection                 | 4    | -    | V    |
|              | <b>Over temperature protection</b>                 |                                      |      |      |      |
| $V_{DDP(T)}$ | Protected drain source supply voltage              | $V_{IS} = 5 \text{ V}$               | -    | 50   | V    |
|              | <b>Short circuit load protection</b>               |                                      |      |      |      |
| $V_{DDP(P)}$ | Protected drain source supply voltage <sup>4</sup> | $V_{IS} = 5 \text{ V}$               | -    | 24   | V    |
| $P_{DSM}$    | Instantaneous overload dissipation                 | $T_{mb} = 25 \text{ }^\circ\text{C}$ | -    | 2.1  | kW   |

### OVERVOLTAGE CLAMPING LIMITING VALUES

At a drain source voltage above 50 V the power MOSFET is actively turned on to clamp overvoltage transients.

| SYMBOL     | PARAMETER                        | CONDITIONS  | MIN. | MAX. | UNIT |
|------------|----------------------------------|---|------|------|------|
| $I_{DROM}$ | Repetitive peak clamping current | $V_{IS} = 0 \text{ V}$  | -    | 45   | A    |
| $E_{DSM}$  | Non-repetitive clamping energy   | $T_{mb} \leq 25 \text{ }^\circ\text{C}; I_{DM} = 25 \text{ A};$<br>$V_{DD} \leq 25 \text{ V};$ inductive load     | -    | 1    | J    |
| $E_{DRM}$  | Repetitive clamping energy       | $T_{mb} \leq 85 \text{ }^\circ\text{C}; I_{DM} = 16 \text{ A};$<br>$V_{DD} \leq 20 \text{ V}; f = 250 \text{ Hz}$ | -    | 80   | mJ   |

### ESD LIMITING VALUE

| SYMBOL | PARAMETER                                 | CONDITIONS   | MIN. | MAX. | UNIT |
|--------|---|--|------|------|------|
| $V_C$  | Electrostatic discharge capacitor voltage | Human body model;<br>$C = 250 \text{ pF}; R = 1.5 \text{ k}\Omega$ | -    | 2    | kV   |

1 Prior to the onset of overvoltage clamping. For voltages above this value, safe operation is limited by the overvoltage clamping energy.

2 A higher  $T_j$  is allowed as an overload condition but at the threshold  $T_{j(TO)}$  the over temperature trip operates to protect the switch.

3 The input voltage for which the overload protection circuits are functional.

4 The device is able to self-protect against a short circuit load providing the drain-source supply voltage does not exceed  $V_{DDP(P)}$  maximum. For further information, refer to OVERLOAD PROTECTION CHARACTERISTICS.

# PowerMOS transistor

## Logic level TOPFET

BUK102-50GL

### THERMAL CHARACTERISTICS

| SYMBOL         | PARAMETER                 | CONDITIONS  | MIN. | TYP. | MAX. | UNIT |
|----------------|---------------------------|-------------|------|------|------|------|
|                | <b>Thermal resistance</b> |             |      |      |      |      |
| $R_{th\ j-mb}$ | Junction to mounting base | -           | -    | 0.8  | 1.0  | K/W  |
| $R_{th\ j-a}$  | Junction to ambient       | in free air | -    | 60   | -    | K/W  |

### STATIC CHARACTERISTICS

$T_{mb} = 25\text{ °C}$  unless otherwise specified

| SYMBOL        | PARAMETER                        | CONDITIONS   | MIN. | TYP. | MAX. | UNIT             |
|---------------|----------------------------------|--|------|------|------|------------------|
| $V_{(CL)DSS}$ | Drain-source clamping voltage    | $V_{IS} = 0\text{ V}; I_D = 10\text{ mA}$  | 50   | -    | -    | V                |
| $V_{(CL)DSS}$ | Drain-source clamping voltage    | $V_{IS} = 0\text{ V}; I_{DM} = 2\text{ A}; t_p \leq 300\ \mu\text{s}; \delta \leq 0.01$  | -    | -    | 70   | V                |
| $I_{DSS}$     | Zero input voltage drain current | $V_{DS} = 12\text{ V}; V_{IS} = 0\text{ V}$  | -    | 0.5  | 10   | $\mu\text{A}$    |
| $I_{DSS}$     | Zero input voltage drain current | $V_{DS} = 50\text{ V}; V_{IS} = 0\text{ V}$  | -    | 1    | 20   | $\mu\text{A}$    |
| $I_{DSS}$     | Zero input voltage drain current | $V_{DS} = 40\text{ V}; V_{IS} = 0\text{ V}; T_j = 125\text{ °C}$                         | -    | 10   | 100  | $\mu\text{A}$    |
| $R_{DS(ON)}$  | Drain-source on-state resistance | $I_{DM} = 25\text{ A}; V_{IS} = 5\text{ V}; t_p \leq 300\ \mu\text{s}; \delta \leq 0.01$ | -    | 30   | 35   | $\text{m}\Omega$ |

### OVERLOAD PROTECTION CHARACTERISTICS

TOPFET switches off when one of the overload thresholds is reached. It remains latched off until reset by the input.

| SYMBOL       | PARAMETER   | CONDITIONS   | MIN. | TYP. | MAX. | UNIT        |
|--------------|---|--|------|------|------|-------------|
| $E_{DS(TO)}$ | <b>Short circuit load protection<sup>1</sup></b><br>Overload threshold energy | $T_{mb} = 25\text{ °C}; L \leq 10\ \mu\text{H}$<br>$V_{DD} = 13\text{ V}; V_{IS} = 5\text{ V}$ | -    | 1.1  | -    | J           |
| $t_{d\ sc}$  | Response time   | $V_{DD} = 13\text{ V}; V_{IS} = 5\text{ V}$  | -    | 0.8  | -    | ms          |
| $T_{j(TO)}$  | <b>Over temperature protection</b><br>Threshold junction temperature          | $V_{IS} = 5\text{ V}; \text{from } I_D \geq 2\text{ A}^2$                                      | 150  | -    | -    | $\text{°C}$ |

### INPUT CHARACTERISTICS

$T_{mb} = 25\text{ °C}$  unless otherwise specified. The supply for the logic and overload protection is taken from the input.

| SYMBOL       | PARAMETER                             | CONDITIONS                                       | MIN. | TYP. | MAX. | UNIT       |
|--------------|---------------------------------------|--|------|------|------|------------|
| $V_{IS(TO)}$ | Input threshold voltage               | $V_{DS} = 5\text{ V}; I_D = 1\text{ mA}$         | 1.0  | 1.5  | 2.0  | V          |
| $I_{IS}$     | Input supply current                  | $V_{IS} = 5\text{ V}; \text{normal operation}$   | -    | 0.2  | 0.35 | mA         |
| $V_{ISR}$    | Protection reset voltage <sup>3</sup> |  | 2.0  | 2.6  | 3.5  | V          |
| $V_{ISR}$    | Protection reset voltage              | $T_j = 150\text{ °C}$                            | 1.0  | -    | -    |            |
| $I_{ISL}$    | Input supply current                  | $V_{IS} = 5\text{ V}; \text{protection latched}$ | 2    | 3.8  | 10   | mA         |
| $V_{(BR)IS}$ | Input clamp voltage                   | $I_l = 10\text{ mA}$                             | 6    | -    | -    | V          |
| $R_{IG}$     | Input series resistance               | to gate of power MOSFET                          | -    | 1.5  | -    | k $\Omega$ |

<sup>1</sup> The short circuit load protection is able to save the device providing the instantaneous on-state dissipation is less than the limiting value for  $P_{DSM}$ , which is always the case when  $V_{DS}$  is less than  $V_{DSP}$  maximum. Refer to OVERLOAD PROTECTION LIMITING VALUES.

<sup>2</sup> The over temperature protection feature requires a minimum on-state drain source voltage for correct operation. The specified minimum  $I_D$  ensures this condition.

<sup>3</sup> The input voltage below which the overload protection circuits will be reset.

**PowerMOS transistor  
Logic level TOPFET**
**BUK102-50GL**
**TRANSFER CHARACTERISTICS**
 $T_{mb} = 25\text{ }^{\circ}\text{C}$ 

| SYMBOL      | PARAMETER                  | CONDITIONS  | MIN. | TYP. | MAX. | UNIT |
|-------------|----------------------------|---|------|------|------|------|
| $g_{fs}$    | Forward transconductance   | $V_{DS} = 10\text{ V}$ ; $I_{DM} = 25\text{ A}$ $t_p \leq 300\text{ }\mu\text{s}$ ;<br>$\delta \leq 0.01$ | 17   | 28   | -    | S    |
| $I_{D(SC)}$ | Drain current <sup>1</sup> | $V_{DS} = 13\text{ V}$ ; $V_{IS} = 5\text{ V}$  | -    | 60   | -    | A    |

**SWITCHING CHARACTERISTICS**
 $T_{mb} = 25\text{ }^{\circ}\text{C}$ .  $R_I = 50\text{ }\Omega$ . Refer to waveform figures and test circuits.

| SYMBOL       | PARAMETER           | CONDITIONS                                     | MIN. | TYP. | MAX. | UNIT          |
|--------------|---------------------|--|------|------|------|---------------|
| $t_{d\ on}$  | Turn-on delay time  | $V_{DD} = 13\text{ V}$ ; $V_{IS} = 5\text{ V}$ | -    | 2    | -    | $\mu\text{s}$ |
| $t_r$        | Rise time           | resistive load $R_L = 1.1\text{ }\Omega$       | -    | 8    | -    | $\mu\text{s}$ |
| $t_{d\ off}$ | Turn-off delay time | $V_{DD} = 13\text{ V}$ ; $V_{IS} = 0\text{ V}$ | -    | 8    | -    | $\mu\text{s}$ |
| $t_f$        | Fall time           | resistive load $R_L = 1.1\text{ }\Omega$       | -    | 8    | -    | $\mu\text{s}$ |
| $t_{d\ on}$  | Turn-on delay time  | $V_{DD} = 13\text{ V}$ ; $V_{IS} = 5\text{ V}$ | -    | 3.7  | -    | $\mu\text{s}$ |
| $t_r$        | Rise time           | inductive load $I_{DM} = 11\text{ A}$          | -    | 3.7  | -    | $\mu\text{s}$ |
| $t_{d\ off}$ | Turn-off delay time | $V_{DD} = 13\text{ V}$ ; $V_{IS} = 0\text{ V}$ | -    | 13   | -    | $\mu\text{s}$ |
| $t_f$        | Fall time           | inductive load $I_{DM} = 11\text{ A}$          | -    | 1.4  | -    | $\mu\text{s}$ |

**REVERSE DIODE LIMITING VALUE**

| SYMBOL | PARAMETER                  | CONDITIONS   | MIN. | MAX. | UNIT |
|--------|----------------------------|--|------|------|------|
| $I_S$  | Continuous forward current | $T_{mb} \leq 25\text{ }^{\circ}\text{C}$ ; $V_{IS} = 0\text{ V}$ | -    | 50   | A    |

**REVERSE DIODE CHARACTERISTICS**
 $T_{mb} = 25\text{ }^{\circ}\text{C}$ 

| SYMBOL    | PARAMETER             | CONDITIONS   | MIN. | TYP. | MAX. | UNIT |
|-----------|-----------------------|--|------|------|------|------|
| $V_{SDS}$ | Forward voltage       | $I_S = 50\text{ A}$ ; $V_{IS} = 0\text{ V}$ ; $t_p = 300\text{ }\mu\text{s}$ | -    | 1.0  | 1.5  | V    |
| $t_{rr}$  | Reverse recovery time | not applicable <sup>2</sup>  | -    | -    | -    | -    |

**ENVELOPE CHARACTERISTICS**

| SYMBOL | PARAMETER                  | CONDITIONS   | MIN. | TYP. | MAX. | UNIT |
|--------|----------------------------|--|------|------|------|------|
| $L_d$  | Internal drain inductance  | Measured from contact screw on tab to centre of die            | -    | 3.5  | -    | nH   |
| $L_d$  | Internal drain inductance  | Measured from drain lead 6 mm from package to centre of die    | -    | 4.5  | -    | nH   |
| $L_s$  | Internal source inductance | Measured from source lead 6 mm from package to source bond pad | -    | 7.5  | -    | nH   |

<sup>1</sup> During overload before short circuit load protection operates.

<sup>2</sup> The reverse diode of this type is not intended for applications requiring fast reverse recovery.

PowerMOS transistor  
Logic level TOPFET

BUK102-50GL

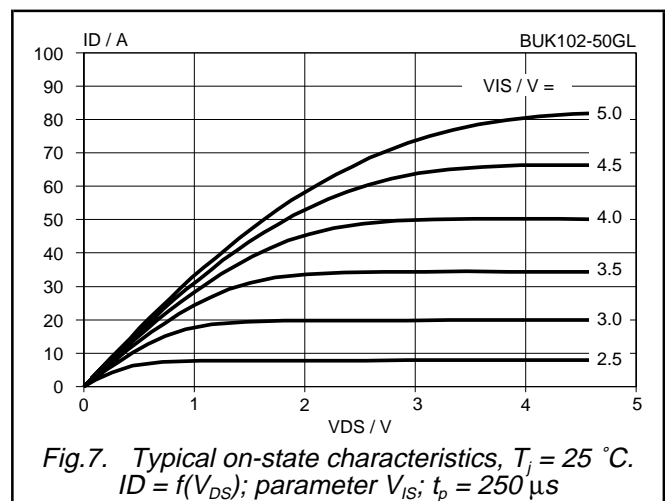
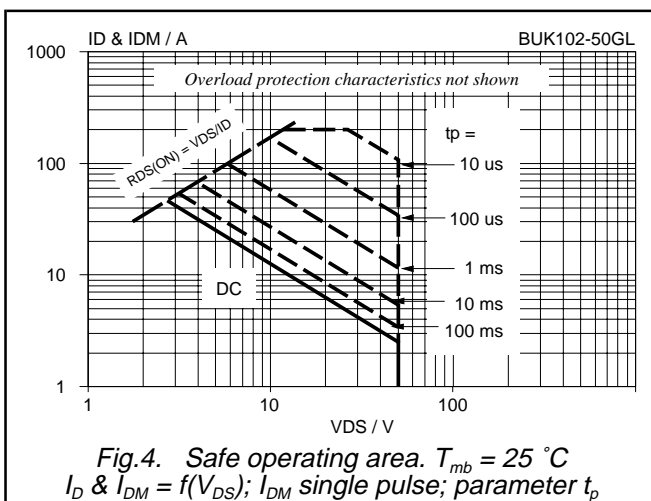
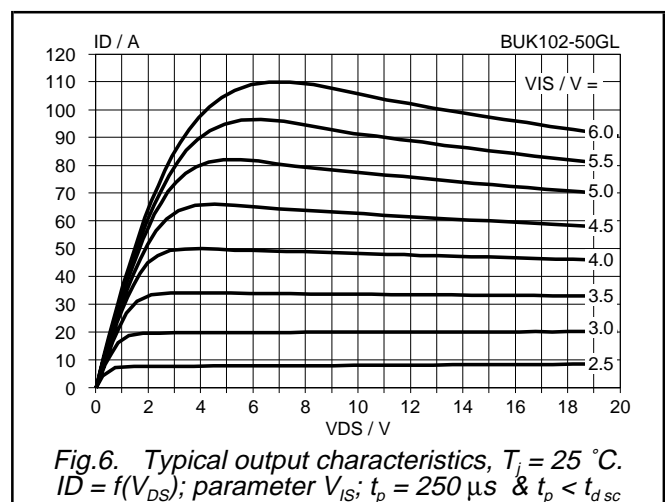
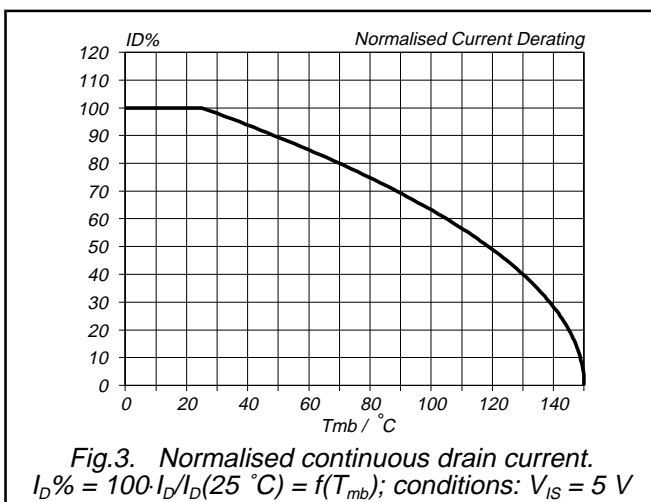
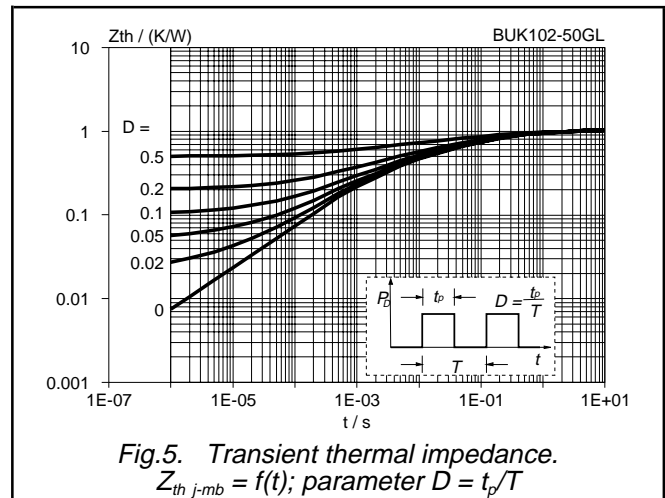
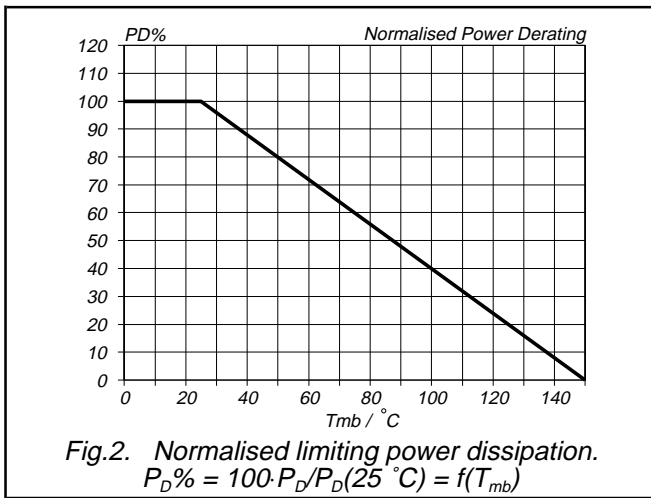

PowerMOS transistor  
Logic level TOPFET

BUK102-50GL

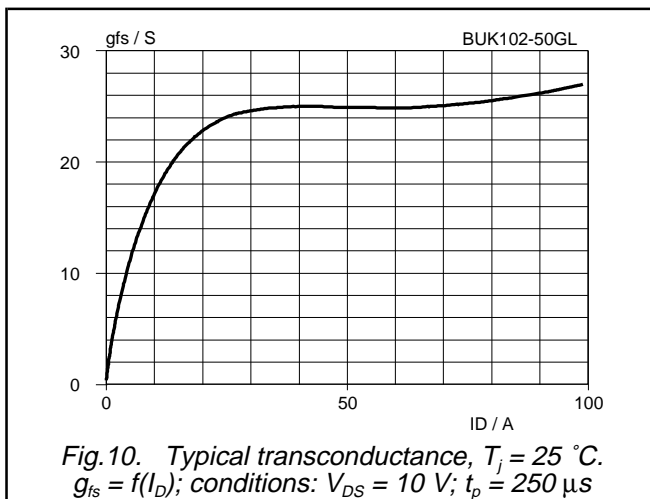
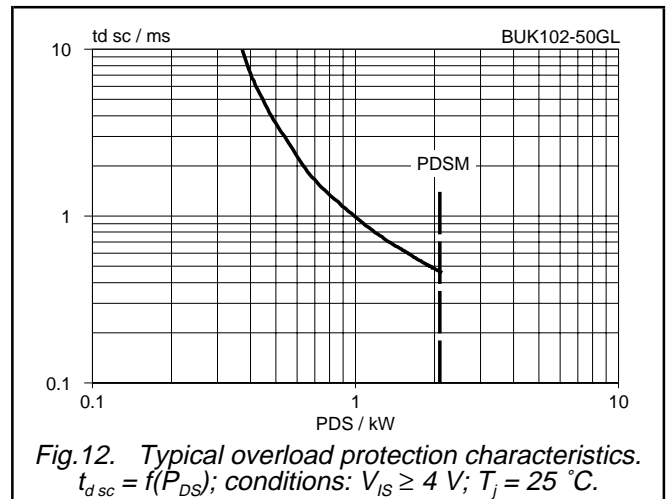
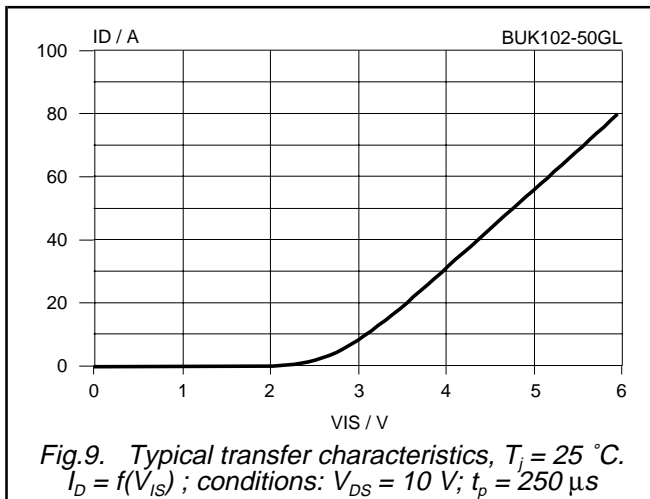
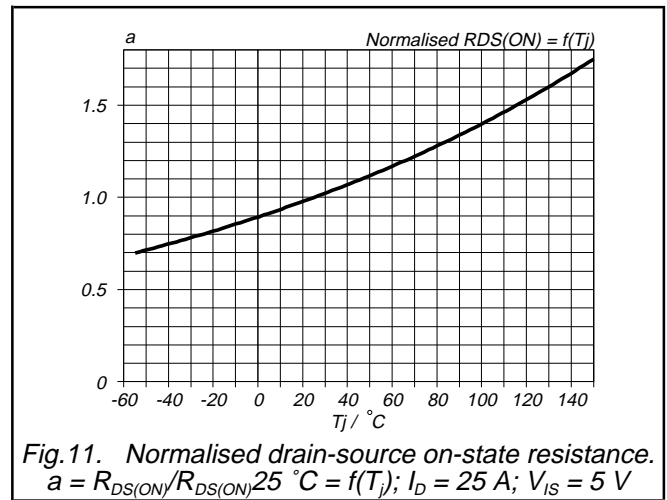
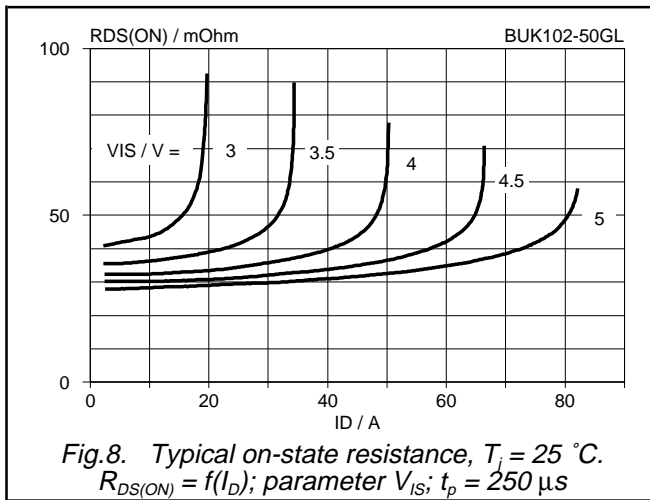

PowerMOS transistor  
Logic level TOPFET

BUK102-50GL

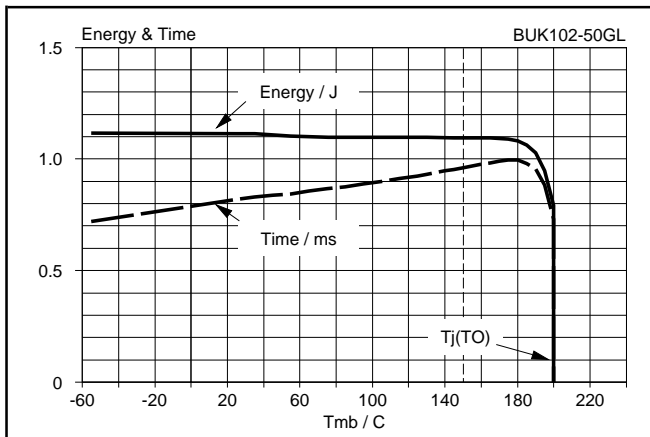

Fig. 14. Typical overload protection characteristics. Conditions:  $V_{DD} = 13\text{ V}$ ;  $V_{IS} = 5\text{ V}$ ;  $SC\text{ load} = 30\text{ m}\Omega$

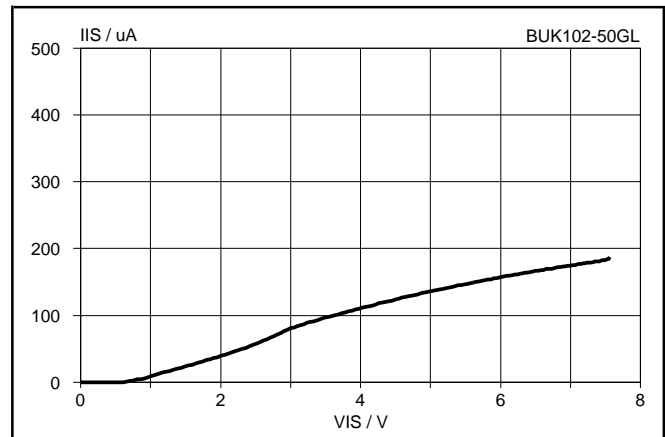

Fig. 17. Typical DC input characteristics,  $T_j = 25\text{ }^\circ\text{C}$ .  $I_{IS} = f(V_{IS})$ ; normal operation

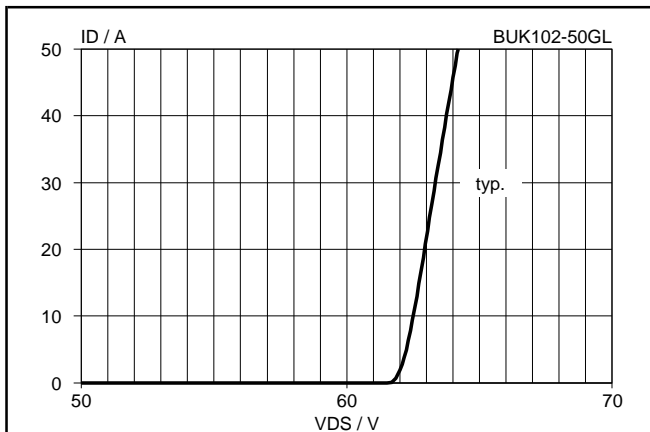

Fig. 15. Typical clamping characteristics,  $25\text{ }^\circ\text{C}$ .  $I_D = f(V_{DS})$ ; conditions:  $V_{IS} = 0\text{ V}$ ;  $t_p \leq 50\text{ }\mu\text{s}$

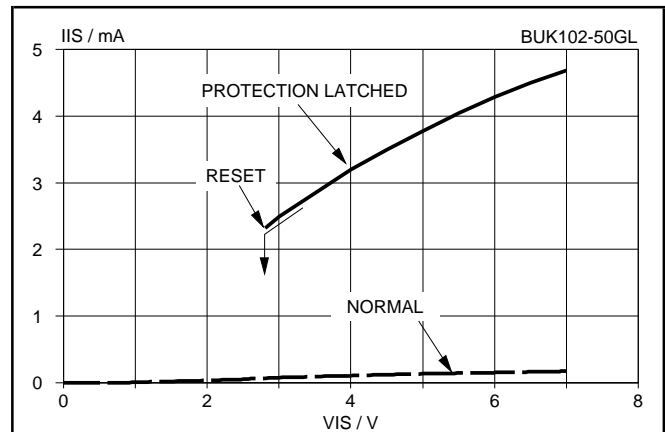

Fig. 18. Typical DC input characteristics,  $T_j = 25\text{ }^\circ\text{C}$ .  $I_{ISL} = f(V_{IS})$ ; overload protection operated  $\Rightarrow I_D = 0\text{ A}$

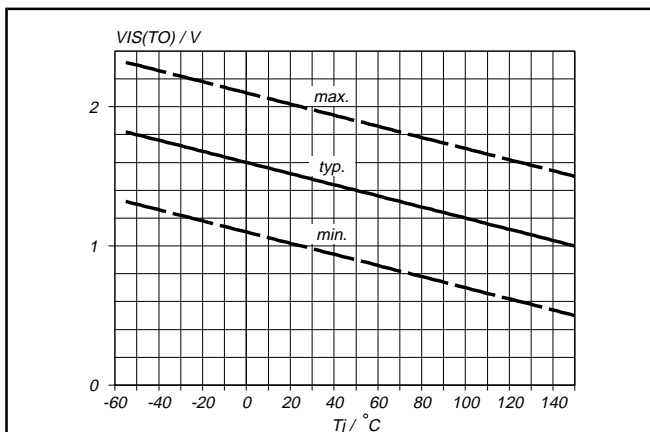

Fig. 16. Input threshold voltage.  $V_{IS(TO)} = f(T_j)$ ; conditions:  $I_D = 1\text{ mA}$ ;  $V_{DS} = 5\text{ V}$

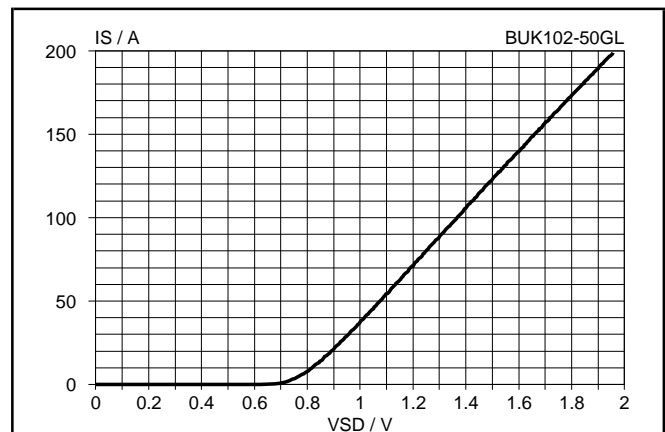
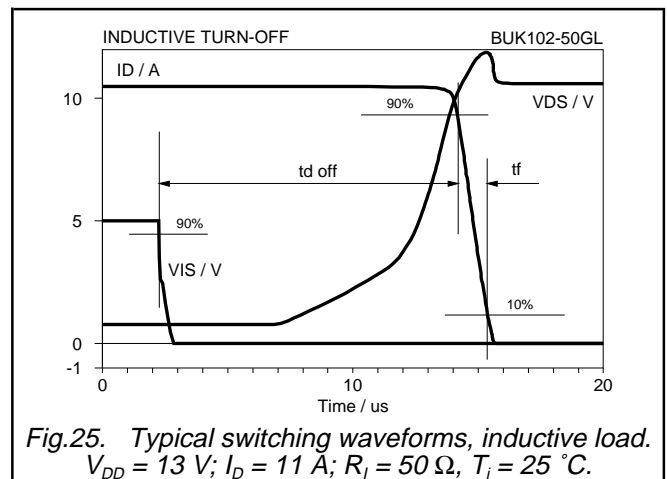
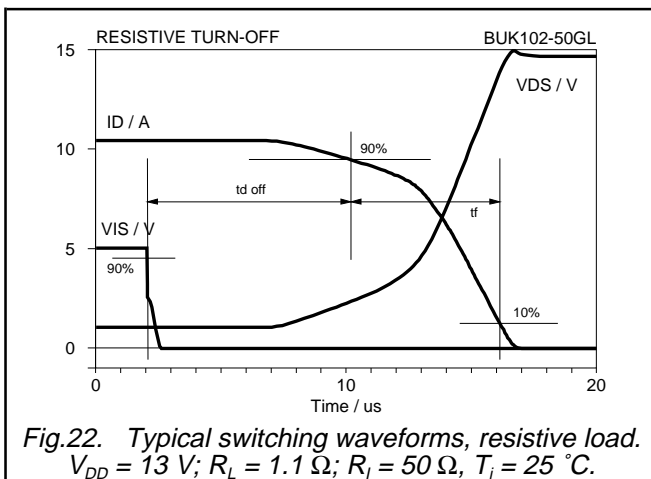
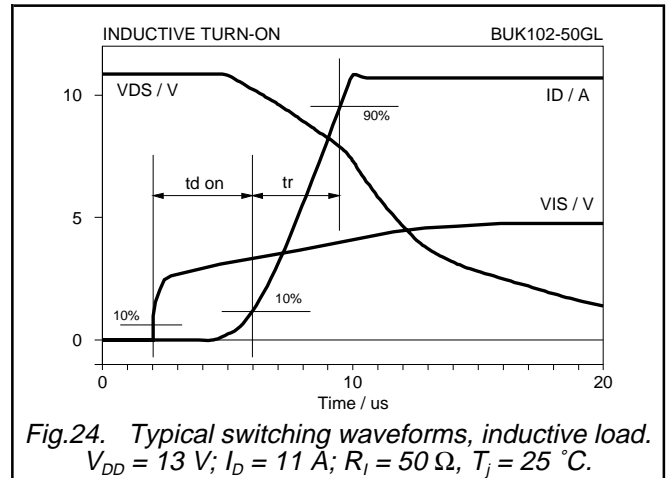
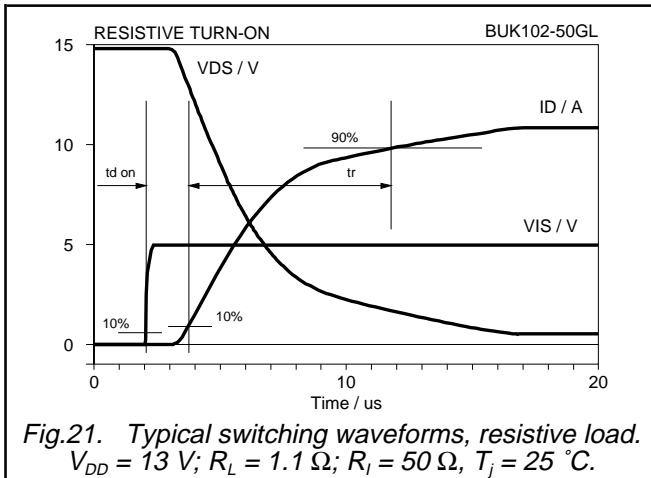

Fig. 19. Typical reverse diode current,  $T_j = 25\text{ }^\circ\text{C}$ .  $I_S = f(V_{SDS})$ ; conditions:  $V_{IS} = 0\text{ V}$ ;  $t_p = 250\text{ }\mu\text{s}$

PowerMOS transistor  
Logic level TOPFET

BUK102-50GL





PowerMOS transistor  
Logic level TOPFET

BUK102-50GL

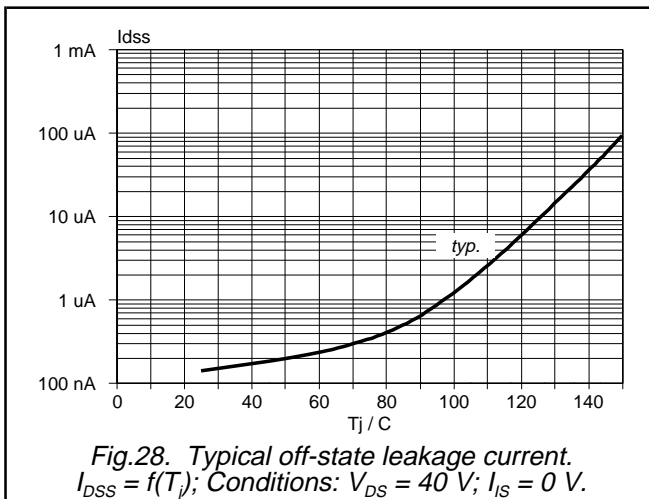
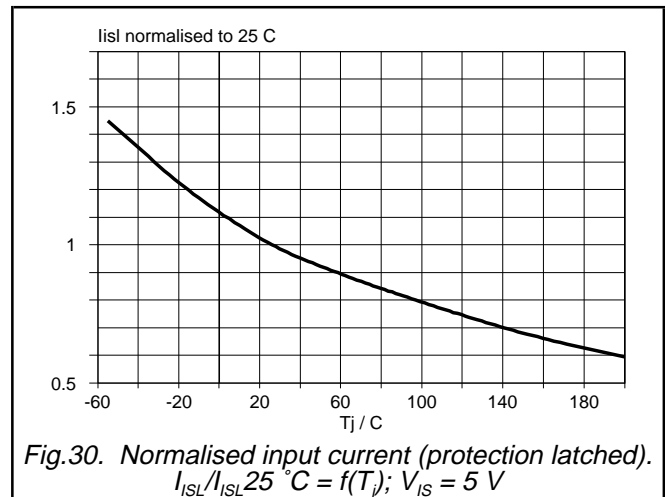
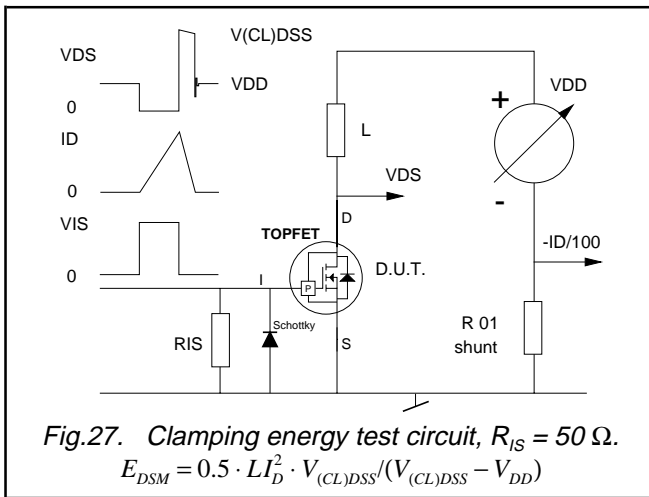
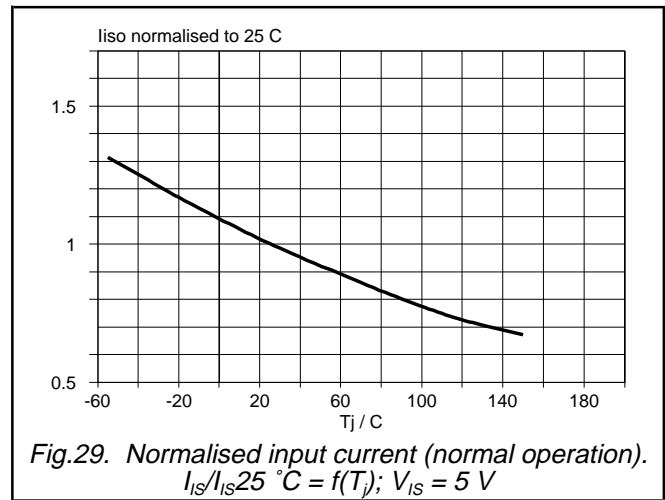
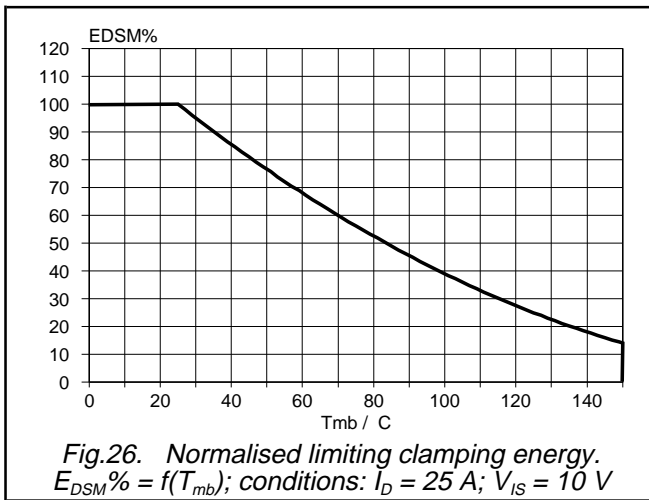

PowerMOS transistor  
Logic level TOPFET

BUK102-50GL

**MECHANICAL DATA**

*Dimensions in mm*

*Net Mass: 2 g*

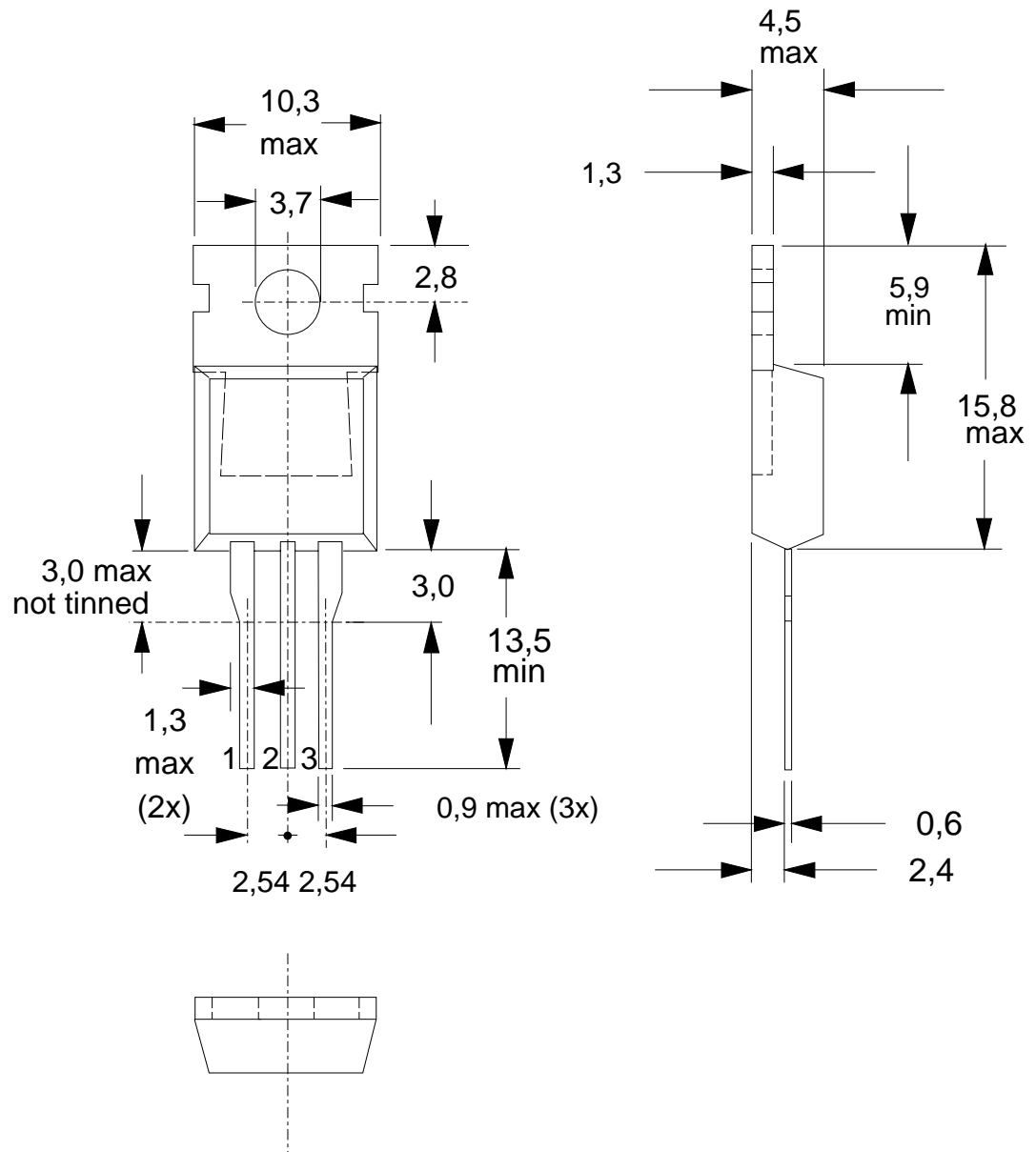

Fig.31. TO220AB; pin 2 connected to mounting base.

**Notes**

1. Refer to mounting instructions for TO220 envelopes.
2. Epoxy meets UL94 V0 at 1/8".

---

**PowerMOS transistor**  
**Logic level TOPFET**

---

**BUK102-50GL**

---

**DEFINITIONS**

|  |   |
|--|---|
| <b>Data sheet status</b>   |   |
| Objective specification  | This data sheet contains target or goal specifications for product development.       |
| Preliminary specification  | This data sheet contains preliminary data; supplementary data may be published later. |
| Product specification  | This data sheet contains final product specifications.                                |
| <b>Limiting values</b>   |   |
| Limiting values are given in accordance with the Absolute Maximum Rating System (IEC 134). Stress above one or more of the limiting values may cause permanent damage to the device. These are stress ratings only and operation of the device at these or at any other conditions above those given in the Characteristics sections of this specification is not implied. Exposure to limiting values for extended periods may affect device reliability. |   |
| <b>Application information</b>   |   |
| Where application information is given, it is advisory and does not form part of the specification.  |   |
| © Philips Electronics N.V. 1996  |   |
| All rights are reserved. Reproduction in whole or in part is prohibited without the prior written consent of the copyright owner.  |   |
| The information presented in this document does not form part of any quotation or contract, it is believed to be accurate and reliable and may be changed without notice. No liability will be accepted by the publisher for any consequence of its use. Publication thereof does not convey nor imply any license under patent or other industrial or intellectual property rights.   |   |

**LIFE SUPPORT APPLICATIONS**

These products are not designed for use in life support appliances, devices or systems where malfunction of these products can be reasonably expected to result in personal injury. Philips customers using or selling these products for use in such applications do so at their own risk and agree to fully indemnify Philips for any damages resulting from such improper use or sale.