

DAEWOO

15", 17" LCD Television

MODEL NO : DSL-15D1T, DSL-17W1T

Instruction Manual



PAL-I,II,PAL/SECAM-B/G,D/K,SECAM-L/L'/NTSC-AV
A2/NICAM STEREO SOUND
TELETEXT
SCART / VIDEO / S-VIDEO / COMPONENT / PC
PICTURE IN PICTURE (PIP)
MULTI-LANGUAGE OSD
Ver. 032302

Special Note for users in Great Britain

ENGLISH

The appliance is supplied with a moulded three pin mains plug fitted with a fuse.
If the fuse requires replacing, a fuse approved to BS11362, BSI or ASTA of the same rating must be used.
Never use the plug with the fuse cover omitted if the cover is detachable.
If a replacement fuse cover is required, it must be of the same colour as the pin face of the plug.
Replacement fuse covers are available from your dealer.

If the fitted plug is not suitable for the mains socket in your house or the cable is not long enough to reach a main socket, you should obtain a suitable safety approved extension lead.
However, if there is no alternative to cutting off the plug, remove the fuse and then safely dispose of the plug.
Do not connect the plug with bared wires to a mains socket as there is a risk of shock hazard.

If a replacement plug is to be fitted, please observe the wiring code shown below.
The wires in the mains lead are coloured in accordance with the following code:

BLUE - NEUTRAL BROWN - LIVE

As these colours may not correspond to the coloured markings identifying the terminals in your plug, proceed as follows:

- The wire coloured BLUE must be connected to the terminal marked with the letter N or coloured BLUE or BLACK.
- The wire coloured BROWN must be connected to the terminal marked with the letter L or coloured BROWN or RED.

WARNING: Do not connect either wire to the earth terminal, which is marked with the letter E or by the earth symbol, or coloured green or green and yellow.

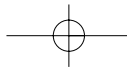



Caution

Safety Precautions

ENGLISH

WARNING: To reduce the risk of fire or electric shock hazard, do not expose this appliance to rain or moisture.

	CAUTION RISK OF ELECTRIC SHOCK DO NOT OPEN	
<p>CAUTION : TO REDUCE THE RISK OF ELECTRIC SHOCK, DO NOT REMOVE COVER (OR BACK). NO USER-SERVICEABLE PARTS INSIDE. REFER SERVICING TO QUALIFIED SERVICE PERSONNEL.</p>		

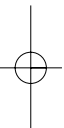

The lightning flash with arrow-head symbol, within an equilateral triangle, is intended to alert the user to the presence of uninsulated "dangerous voltage" within the product's enclosure that may be of sufficient magnitude to constitute a risk electric shock.



The exclamation point within an equilateral triangle is intended to alert the user to the presence of important operating and servicing instructions in the literature accompanying the product.

1. CLEANING

Unplug this TV equipment from the AC power outlet before cleaning. Do not use liquid cleaner or aerosol cleaners. Use a soft and damp cloth for cleaning.

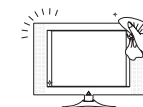

2. ATTACHMENTS

Do not use attachments not recommended by the TV equipment manufacturer as they may result in the risk of fire, electric shock or other injury.



3. WATER AND MOISTURE

Do not place this TV equipment near water, for example, near bathtub, kitchen sink, laundry tub, in a wet basement, or near a swimming pool, or the like.

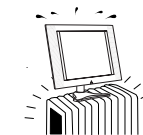

4. HEAT

Keep the TV equipment away from the heat sources such as radiator, heater, stoves and other heat-generating products

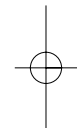

5. SETTING

Do not place this TV on unstable cart, stand, or table. Placing the TV on an unstable base can cause the TV to fall, resulting in serious personal injuries as well as damage to the TV. Use only a cart, stand, bracket or table recommended by the manufacturer or salesperson.



6. WALL OR CEILING MOUNTING

When mounting the product on a wall or ceiling, be sure to install the product using the designated mounting tool according to the method recommended by the manufacturer.



7. POWER SOURCES

This TV equipment should be operated only from the type of power source indicated on the marking label. If you are not sure of the type of power supplied to your home, consult your TV dealer or local power company.

8. PIXEL

The LCD panel is a very high technology product with 2,359,296(2,949,120-only 17") thin film transistors give you fine picture details. Occasionally, a few non-active pixels may appear on the screen as a fixed point of blue, green or red please note that this does not affect the performance of your product.

Contents

Important Safeguards

ENGLISH

- IMPORTANT SAFEGUARDS 1
- SUPPLIED ACCESSORIES 2
- FUNCTIONAL OVERVIEW 3
 - Front 3
 - Control panel 4
 - Remote controller 5
- PREPARATION 6
 - Inserting Batteries into the Remote Control Unit 6
 - Mains connection 6
 - Aerial connection 7
 - Connecting external equipment 9
- INSTALLATION 12
 - Language selection 12
 - Automatic Tuning of TV Channels 12
 - Programme Editing 13
 - Manual Setup 14
- DAILY USE 16
 - Switching On and Off 16
 - Status 16
 - Programme Selection 17
 - Picture Control 17
 - Sound Control 19
 - Special Features 20
 - Sleep 20
 - Still 20
 - Hotel mode 21
 - Teletext (Option) 21
 - PC setup 23
 - PIP (Picture in Picture) 24
- TROUBLESHOOTING 25
- WALL/ARM MOUNTING 26
- PRODUCT SPECIFICATIONS 27

Location

Heat, Moisture, Dust, Vibration

Position your set so that bright light or sunlight doesn't fall directly onto the screen. Care should be taken not to expose the set to any unnecessary vibration, moisture, dust or heat. Do not expose the set to dripping or splashing.

Ventilation

Also ensure that the set is placed in a position to allow a free flow of air. Do not cover the ventilation openings on the back cover. Leave at least 10 cm around each side of the TV set.

Mounting

This set can be positioned by using the table top stand or wall mounting bracket. When you install the set using the wall mounting bracket, fix it carefully so it is secure.

Object Entry

Do not insert foreign objects, such as needles and coins, into the ventilation openings.

Lightning striking

You should disconnect your set from the mains and the aerial system during thunderstorms.

Cleaning

Unplug the set from the mains before cleaning. Dust the set by wiping the LCD screen and the cabinet with a soft, clean cloth. If the screen requires additional cleaning, use a clean, damp cloth. Do not use liquid cleaners or aerosol cleaners.

Do not rub or strike the LCD with anything hard as this may scratch, or damage the LCD permanently.

Service

Never remove the back cover of the set as this can expose you to high voltage and other hazards. If the set does not operate properly, unplug it and call your dealer.

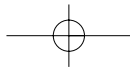

Supplied Accessories

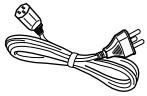

AC cord



AC adapter



Remote controller



Instruction manual

NOTE : Batteries are not included

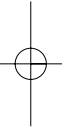

Functional Overview

ENGLISH

Front

DSL-15D1T



Remote sensor
LED indicator

DSL-17W1T



Remote sensor
LED indicator



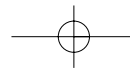

Functional Overview

Functional Overview

ENGLISH

Control panel

Remote Controller

[] : Teletext function

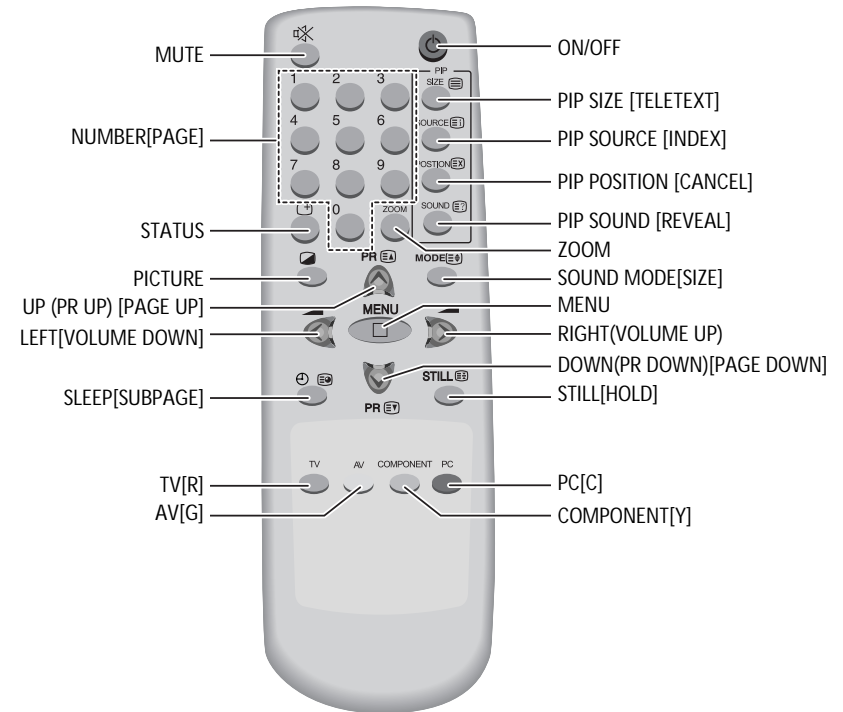
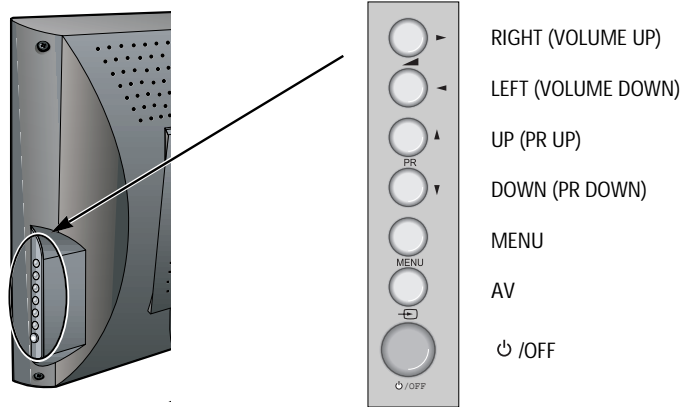

Preparation

Inserting Batteries into the Remote Control Unit

To load the batteries, turn the remote control handset over and open the battery compartment. Insert the batteries (Not supplied, two 1.5v, type R03 or AAA).

Make sure that the polarity matches with the (+) and (-) marks inside of the battery compartment.

Note: To avoid damage from possible battery leakage, remove the batteries if you do not plan to use the remote control handset for an extended period of time.

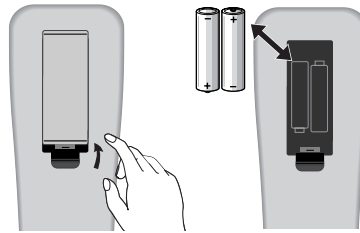

Mains Connection

1. Connect the DC plug of the AC adaptor to the DC 12V input terminal of the set.
2. Connect the AC adaptor and AC cord.
3. Plug the other end of AC cord into a Power outlet with 100V - 240V AC, 50/60Hz.

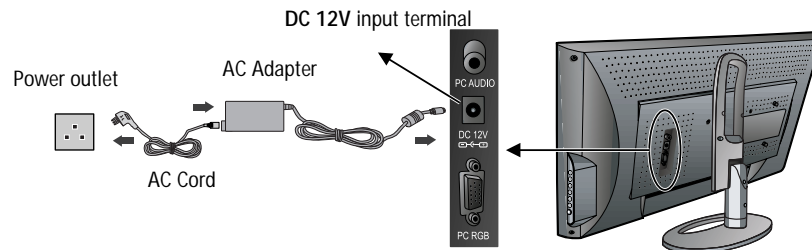

Preparation

Aerial Connection

CONNECTING THE TV DIRECTLY TO AN AERIAL

Connect an aerial cable (75 ohm coaxial cable) to the Aerial terminal on the back of the TV set.

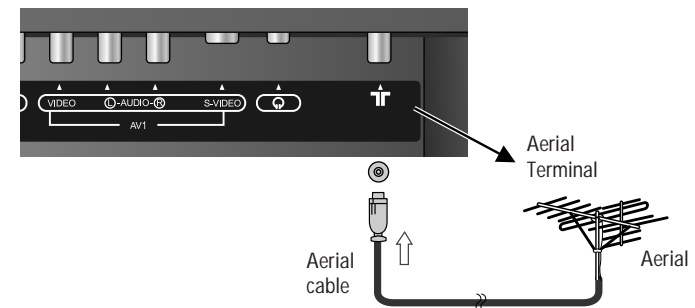

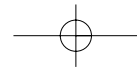

Preparation

AERIAL CONNECTION WITH VCR

Connect your aerial cable ① to the RF(aerial) IN terminal on the VCR.
 Connect the RF OUT terminal of the VCR to the Aerial terminal on the TV set with RF cable ②.

NOTE: If you wish to use only the Aerial (RF) connection, then you should store the VCR channel on programme number "ZERO" using the "Manual setup" function (See page 14).
 Now you can watch VCR in TV mode by selecting the programme number "PR00".

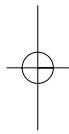
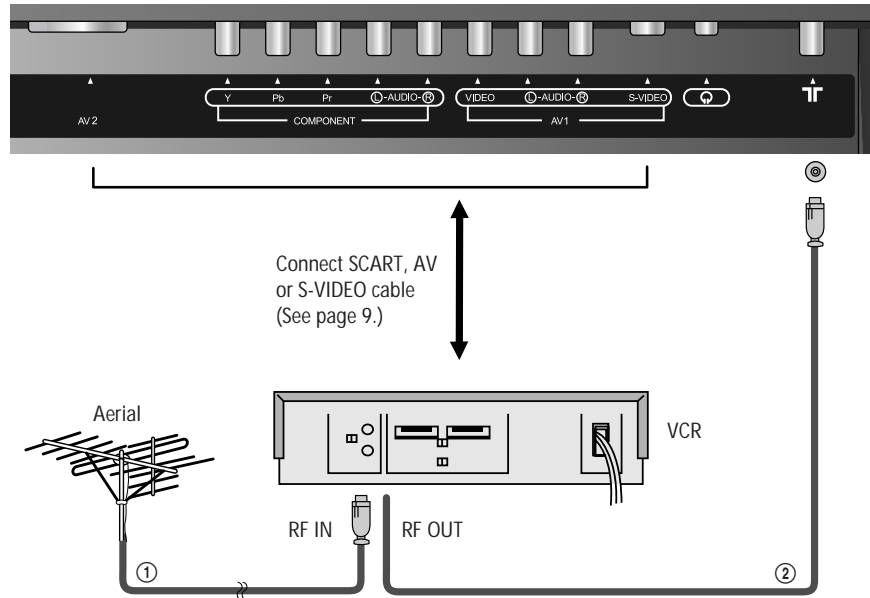

Preparation

ENGLISH

Connecting external equipment

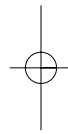
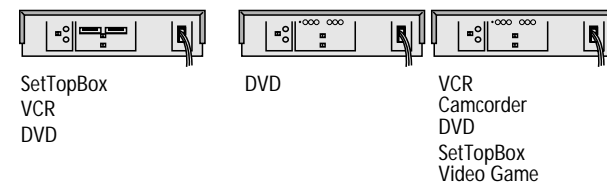
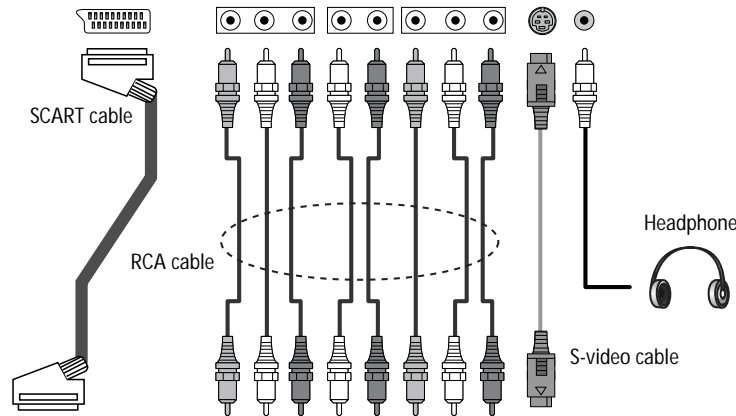
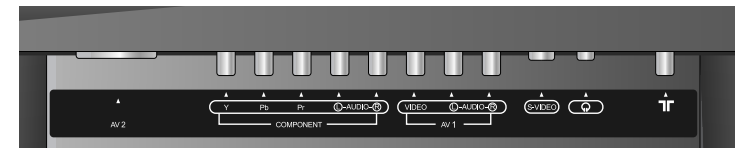
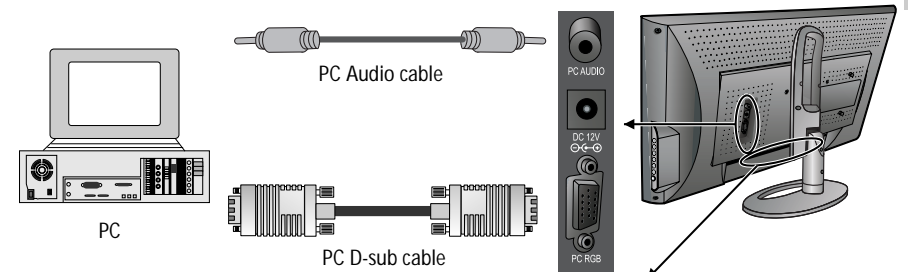

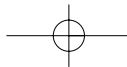

Preparation

TV/AV/PC MODE SELECTION

Press the **AV** () button on the control panel repeatedly to select the source, **TV** → **AV1**(or **AV1/S-video**) → **Component** → **AV2**(or **AV2/RGB**) → **PC** → **TV** → You can select the source direct using the **TV**, **AV**, **COMP**, **PC** button on the remote controller. Press the **AV** button on the remote controller repeatedly to select **AV1** or **AV2**. In **AV** mode, you can change the TV programme number with the **UP/DOWN** button or the **NUMBER** button.

NOTE : When the TV SET is no signal, OSD(On Screen Display) appears on the screen.

AV INPUT JACK (AV1)

This jack has video / audio inputs. It is used to connect a VCR, Camcorder, DVD, STB, Video game.

S-VIDEO INPUT JACK (AV1/S-VIDEO)

It has Y/C inputs. This jack is used to connect S-Video equipment. **NOTE**: The AV Audio input Jack and S-video Audio input Jack are shared connections. So, you can not connect both the AV Audio Input cable and S-video Audio Input cable. When the S-video Jack is connected, the TV set switches automatically to **AV1/S-video** mode.

COMPONENT INPUT JACK (COMPONENT)

This jack has Y/Pb(Cb)/Pr(Cr) inputs and audio inputs. It is used to connect a DVD.

SCART JACK (AV2, AV2/RGB)

This jack has video / audio inputs and outputs, RGB inputs. It is used to connect a STB, VCR, DVD. When the signal is RGB, the TV set switches automatically to **AV2/RGB** mode. In most cases, the TV set switches automatically to **AV2**(or **AV2/RGB**) mode, when the external equipment connected is in playback mode. If not, then use the **AV** button to select **AV2**(or **AV2/RGB**).

HEADPHONE JACK

Insert the headphone plug(3.5 mm ø) into this jack(). The sound from the speaker will be automatically cut off. You can control the headphone sound with the **LEFT/RIGHT** button.

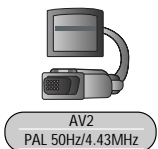
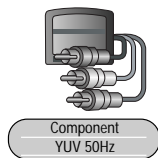
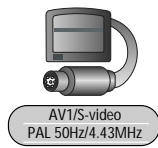
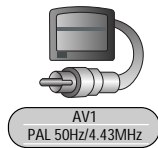
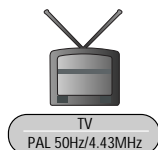

D-SUB JACK (PC RGB)

This jack has RGB inputs and is used to connect a PC.

Display mode

If the signal from the PC system equals one of the standard signal modes, the screen will automatically adjust and display image. If the signal from the PC system doesn't equal any of the modes, adjust the Video card setting on the computer. For the display modes listed below, the screen image has been optimized during manufacture. The message "Out Of Range" will appear when the PC signal does not correspond to any of the below standard setting.

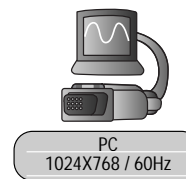

Standard	Resolution(Mode)	V-frequency (Hz)	H-frequency(kHz)
MAC	640x480	60	31.47
		66	35.00
	832x624	75	49.73
IBM	1024x768	60	48.78
		75	60.24
	640x350	70	31.47
	640x480	60	31.47
VESA	720x400	70	31.47
	640x350	85	37.86
	640x400	85	37.86
	640x480(VGA)	72	37.86
		75	37.50
		85	43.27
	720x400	85	37.93
	800x600(SVGA)	56	35.16
		60	37.88
		72	48.08
1024x768(XGA)		75	46.88
		85	53.67
		60	48.37
		70	56.48
		75	60.02
		85	68.68
		60	47.70
1280x768(WXGA-only 17")			

PC AUDIO INPUT JACK

Connect the stereo audio cable to the **PC AUDIO** jack and the other end to the Audio Out terminal of the Sound card on your PC.

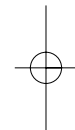

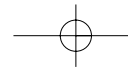

Installation

Installation

ENGLISH

Language Selection

1. When you turn on the TV set(see page16) for the first time, the **Language** menu for the on-screen display appears.



If not,

- (1) Press the **MENU** button to call up the menu.
- (2) Move the selection bar to the **Feature** menu with **UP/DOWN** button.
- (3) Press the **RIGHT** button.
- (4) Move the selection bar to the **Language** with **UP/DOWN** button.

2. Press the **LEFT/RIGHT** button to choose the language you want .
3. Press the **MENU** button to escape from menu.

Automatic Tuning of TV Channels

1. Press the **MENU** button to call up the menu.
2. Move the selection bar to the **Setup** menu with **UP/DOWN** button.
3. Press the **RIGHT** button.
4. Place the selection bar on **Auto setup** and press the **RIGHT** button.
5. Place the selection bar on the Country you require with **UP/DOWN** button.

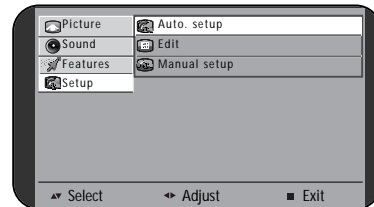

- GB : Great Britain
- D : Germany
- F : France
- CH : Switzerland
- IRE(I) : Ireland, Hong Kong, S/Africa
- I : Italy
- Euro(BG) : West and North Europe, N/Zealand, Middle-East, Asia, Africa
- E-Euro(DK) : East Europe, CIS, Vietnam
- AUS : Australia
- CHI : China

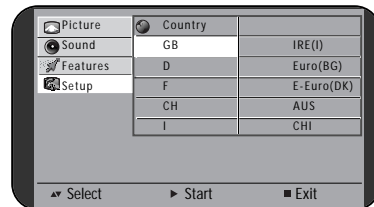

6. Press the **LEFT/RIGHT** button.
All available TV channels(CH) are searched for and stored from programme number (PR) 1 onwards automatically.
The names of the TV channels are stored as well if the TV channels broadcast VPS, PDC or Teletext.

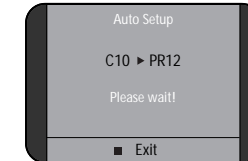

7. Please wait until the tuning screen disappears.

Programme Editing

Call up the **Edit** menu from the **Setup** menu.

DELETING THE PROGRAMME

1. Position the selection bar to the programme to delete with the **UP/DOWN** buttons.
2. Press the **RED** button.
The selected TV channel is deleted, all the following channels are shifted up one position.

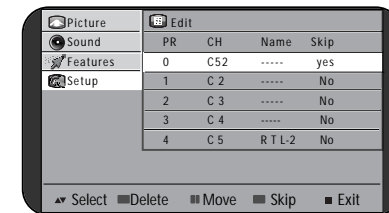

MOVING THE PROGRAMME

1. Select the programme to move with **UP/DOWN** button.
2. Press **GREEN** or **YELLOW** button to move the selected programme up or down to the desired programme number.

SKIPPING THE PROGRAMMES

1. Select **SKIP** "Yes" or "No" with the **CYAN** button.
2. The programme marked with **SKIP** "Yes" doesn't appear on screen when selecting a programme using the **UP/DOWN** button or **NUMBER** button.

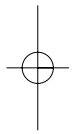

Installation

Manual setup

Call up **Manual Setup** from the Setup menu.

PROGRAMME NUMBER SELECTION

1. Position a selection bar to **PR**.
2. Press the **LEFT/RIGHT** buttons to select a programme number you want.

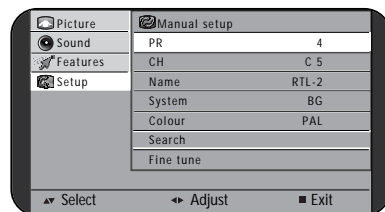

TV SYSTEM SELECTION

If necessary, you can change the TV System.

1. Position a selection bar to **System**.
2. Select the TV system with **LEFT/RIGHT** button.
 - BG** : West and North Europe, Australia, N/Zealand, Middle-East, Asia, Africa
 - DK** : East Europe, CIS, China, Vietnam
 - I** : Great Britain, Ireland, Hong Kong, S/Africa
 - L** : France, Switzerland

NOTE : The L is displayed only when you had selected the Country "F" or "CH" in **Auto setup**.

CHANNEL SEARCH

Up/Down Search

1. Position the selection bar to **Search**.
2. Press the **RIGHT** or **LEFT** button to search up or down. Searching will stop at the next channel found and then the channel will be stored automatically.

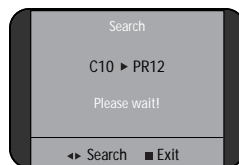

Direct Search

You can directly locate a program by entering the channel number.

1. Position the selection bar to **CH**.
2. Select a channel with **LEFT/RIGHT** button. The selected channel will be stored automatically.

Installation

FINE TUNING

If you are unable to get a good picture or sound because of a poor broadcast signal, it is possible to adjust the fine tuning.

1. Move the selection bar to **Fine tune**.
2. Press the **RIGHT** or **LEFT** button to activate fine tuning up or down.

It operates while the **RIGHT/LEFT** button is being pressed.

The change is stored automatically.



ENTER A STATION NAME

You can change an existing name, or enter a name where none exists.

1. Move the selection bar to **Name**.
2. Press the **RIGHT** buttons to call up the **Name** menu.
3. Select the position with **UP/DOWN** button.
4. Use the **LEFT/RIGHT** buttons to select the desired character :

A B C ... Z + - . (blank) 1 2 ... 9

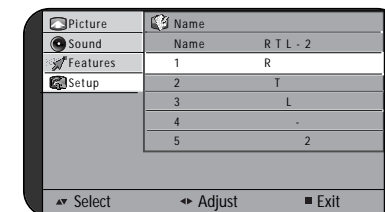

COLOUR STANDARD SELECTION

If necessary, you can change the Colour standard.

1. Position a selection bar to **Colour**.
2. Use the **LEFT/RIGHT** buttons to select the desired Colour standard : **PAL** ↔ **SECAM** ↔

NOTE : In the AV mode

PAL ↔ SECAM ↔ AUTOM ↔

Daily Use

Switching On and Off

SWITCHING ON

- If the Indicator is not lit, then the TV set is powered off.
You must press the **OFF** button on the TV set.
The set will switch to stand-by mode and then the Indicator will illuminate in Red.
- Press the **OFF** button, **UP/DOWN** button or **NUMBER** button on the remote controller or **UP/DOWN** button on the TV set.
The TV set will be switched on and then the Indicator will change to Green.

SWITCHING OFF

- Press the **OFF** button on the remote controller to return the set to its stand-by mode.
The Indicator will illuminate in Red.
- Press the **OFF** button on the TV set to switch the TV set off completely.

NOTE: If you don't use the set for extended periods of time, unplug the AC cord from Power outlet.

Status

The **STATUS** button() is used to display the current status; Mode (AV, Component, PC) and Signal information for 2 seconds.

In TV mode, the Programme number and Station Name, Sound mode are displayed.

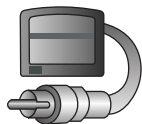

AV1
PAL 50Hz/4.43MHz

PR 12 - - - - -
NICAM Stereo

Daily Use

ENGLISH

Programme Selection

The set has 100 programme numbers, PR00..PR99.

DIRECT SELECTION

The **NUMBER** buttons are used for direct programme selection.
To select a two-digit programme, press the second numbered button within 2 seconds.

UP/DOWN SELECTION

You can also select a programme by pressing step by step the **UP/DOWN** buttons.

Picture Control

- Call up the **Picture** menu.
- Select and adjust the level of each function:
"Brightness", "Contrast", "Colour",
"Sharpness".

The adjusted levels are stored automatically in **Favourite** mode.

NOTE: Tint is displayed only when receiving a NTSC signal.
Only **Brightness** and **Contrast** are displayed in PC mode.

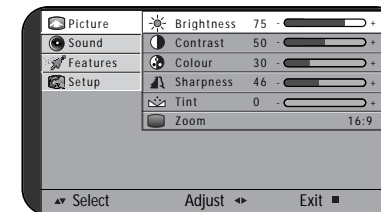

SMART PICTURE SELECTION

When you press the **PICTURE** button() repeatedly, you can call up four pictures settings;
Normal → **Bright** → **Dark** → **Favourite** → **Normal** →

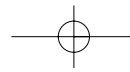

ENGLISH

ZOOM (ASPECT RATIO) CONTROL

You can select the desired aspect ratio with the **ZOOM** button on the remote controller

The following picture formats are available:

4:3 → 16:9 → Waterglass → Zoom → 4:3 → for DSL-15D1T

16:9 → 4:3 → Panorama → Zoom → 16:9 → for DSL-17W1T

Normal → Wide → Normal → in PC mode for DSL-17W1T

DSL-15D1T

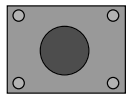

4:3

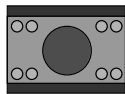

16:9

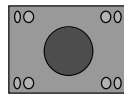

Waterglass

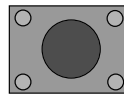

Zoom

DSL-17W1T

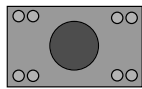

16:9

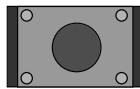

4:3

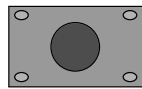

Panorama

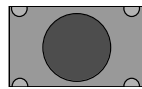

Zoom

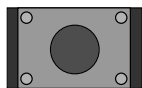

Normal

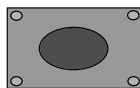

Wide

Sound Control

VOLUME CONTROL

Adjust the volume with the **LEFT/RIGHT** buttons.

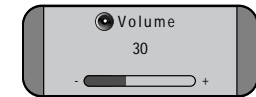

MUTE

Pressing the **MUTE** button (⊘) turns the sound off. The **MUTE** symbol will be displayed. The sound returns if the button is pressed once more.

SOUND CONTROL

Call up the **Sound** menu.

Bass Use this to adjust the low tone.

Treble Use this to adjust the high tone.

Balance Use this to adjust sound balance between the left and right speakers.

Spatial If you select "Yes", the Spatial sound effect is available.

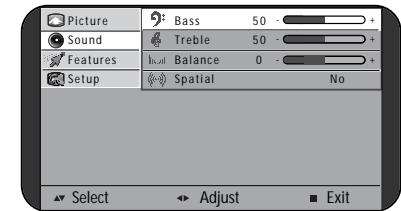

SOUND MODE

Stereo/Mono sound selection

When receiving a Stereo programme, **Stereo** mode is automatically selected. In Stereo reception if you are unable to get good sound quality due to poor reception, you can force a change from Stereo to Mono transmission by pressing the **MODE** button.

Then the program status display indicates **(Mono)**. To return back to Stereo, press the **MODE** button again. The setting can be individually selected for each PR number.

Language Selection

When receiving a bilingual programme, **Sound 1** mode is automatically selected. The **MODE** button allows you to toggle between the first and second language.

The program status display will indicate "Sound 1", "Sound 2" or (Mono).

NOTE: When receiving a NICAM signal, "NICAM" will be displayed.

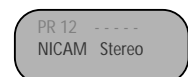
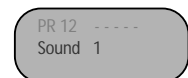
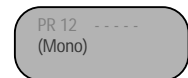
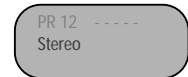

Daily Use

Daily Use

Special Features

Call up the **Feature** menu.

CHILD LOCK

The set is child-locked by selecting "Yes". You can prevent the use of the TV set without the remote control.

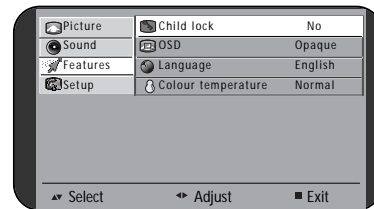

NOTE: When a Child lock is activated, the LED will be blinking the red and green in Stand-By mode in 3 seconds..

OSD BACKGROUND

If you select **Translucent**, the OSD (On-Screen Display) back-ground appears translucent. If you select **Opaque**, the OSD back-ground appears opaque.

COLOUR TEMPERATURE CONTROL

You can change the tone of colour.

Normal: Normal white

Warm : Reddish white

Favourite: In this mode, you can change the Red, Green and Blue value separately.

Cool: Bluish white

Sleep

By pressing the **SLEEP** button (⊖) repeatedly, you can select one of the following setting:

Sleep 0 → Sleep 30 → Sleep 60 → Sleep 90 → Sleep 120 → Sleep 0 →

The set will turn off after the time you select.

NOTE: If a broadcast signal is not present for about 10 minutes, the set will be automatically turned to stand-by mode.

Still

The **STILL** button allows you to freeze the picture at anytime. To return to normal viewing, press the **STILL** button again.

Hotel mode

In the **HOTEL** mode, the **Setup** menu is not displayed and the **Volume** control is limited by half.

1. Press the **RED, GREEN, YELLOW, CYAN, ON/OFF** button on the remote controller in sequence within 5 second.
2. Repeat the above procedure 1 to exit from the **HOTEL** mode.

Teletext (Option)

SWITCHING TELETEXT ON/OFF

Press the **TELETEXT** button (⊞).

The index page or the page viewed last will appear.

Press the **TELETEXT** button again to return to the TV mode.

NOTE: Teletext works only in TV mode.

COLOUR BUTTONS IN TOP/FLOF TELETEXT

A red, green, yellow and blue field is shown at the bottom of the screen.

If TOP or FLOF Teletext is transmitted by the station, pressing the corresponding colour button **R,G,Y,C** on the remote controller, you can select the desired page easily.

SELECTING PAGES

The **NUMBER** buttons are used to enter a page number.

The selected page number appears at the top of the screen and the page appears after a short time.

The **UP/DOWN** buttons increase or decrease the current page number by 1.

INDEX PAGE

You can switch directly to the programme preview(with TOP text) or the overview page of the station you are currently viewing by pressing the **INDEX** button (⊞).

PAGE HOLD

Several sub pages can be combined under a page number and are scrolled at an interval determined by the television station. The presence of sub pages is indicated by, for example, 3/6 beneath the time, which means that you are looking at the 3rd page of a total of 6 pages.

If you want to look at a subpage for a longer period of time, press the **HOLD** button (⊞).

The **HOLD** symbol appears and the contents of the subpage shown are kept on the screen and no longer updated or switched to other subpages.

Pressing the **HOLD** button again, the current subpage appears.

Daily Use

CALLING UP SUBPAGE DIRECTLY

Pressing the SUBPAGE button (), "S - - - -" appears.

Enter the subpage number that you want to call up with the **NUMBER** button, for example, the 2nd page, sequence 0002.

The desired subpage will eventually be displayed on the screen and holds it there.

Meanwhile whilst you are waiting, it is possible to go back to the TV picture by pressing the **CANCEL** button()on the remote and after a while, press the **CANCEL** button again to revert back to the saved Teletext sub page.

WATCHING TV DURING TELETEXT MODE

Some pages are continually updated, for example, stock market reports, sports announcements, and the latest news.

If you want to watch television and stay informed at the same time, press **CANCEL** button ().

The regular programme is still visible and the Teletext page number appears at the top of the screen.

Pressing the **CANCEL** button, the Teletext page appears with the updated information.

REVEAL ANSWER

This function can be used on certain pages to reveal the solution of riddles.

Press the **REVEAL** button ()to reveal a hidden answer and press again to hide it.

DOUBLING CHARACTER SIZE

Repeatedly pressing the **SIZE** button ()doubles the character size in the following order:

Upper half of the page → **Lower half of the page** → **Normal size** → **Upper half of the page** →

Daily Use

PC setup

Call up **Setup** menu in the PC mode.

H-POSITION AND V-POSITION

Use this to adjust the horizontal and vertical position of the displayed image.

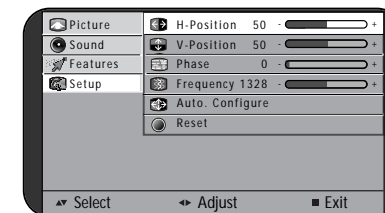

PHASE

This function allows you to remove any horizontal noise and clear or sharpen the image of characters.

FREQUENCY

This function is to minimize any vertical bars or stripes visible on the screen background.

And the horizontal screen size will also change.

AUTO. CONFIGURE

This function is for the automatic adjustment of the screen POSITION, PHASE and FREQUENCY.

NOTE: Some signal from some Video cards may not function properly. If the results are unsatisfactory, adjust POSITION, PHASE and FREQUENCY manually.

RESET

Use this to initialize the adjusted value.

DPMS(Display Power Mangement Signaling)

When the pc is in the power saving mode, the TV set automatically will go into a DPMS mode to save the energy and, the LED will be blinking the red and green after 1 second.

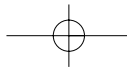

Daily Use

Troubleshooting

ENGLISH

PIP (Picture in Picture)

In PC mode, you can watch TV or an AV device such as a VCR or DVD a small window super-imposed on the PC.

Call up PIP in the Feature menu.

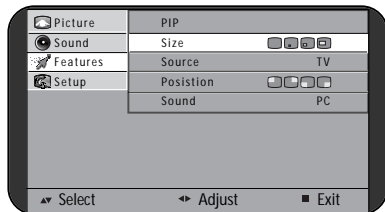

PIP ON/OFF AND PIP SIZE SELECTION

Use this to switch the PIP on or off and select the PIP size among **Small**, **Middle**, **Large**.

You can control with **PIP-SIZE** button using the remote controller.

PIP SOURCE SELECTION

Use this to select the PIP input signal among **TV**, **AV1 (S-Video)**, **Component** or **AV2 (RGB)**.

You can select the PIP input signal with **PIP-SOURCE** button on the remote controller.

When PIP input is TV, you can select a TV program with **UP/DOWN** button.

NOTE: **Component** source only works in 576i, 480i signal.
The 576p, 480p, 720p, 1080i signals are not available.

PIP POSITION SELECTION

Use this to select the picture position among **Right-Top**, **Left-Top**, **Left-Bottom** or **Right-Bottom**.

You can select the picture position with **PIP-POSITION** button on the remote controller.

SOUND OUTPUT SELECTION IN PIP MODE

Use this to select the output sound, **PC** or **PIP (TV, AV, Component)** for the loudspeakers or headphone in PIP mode.

You can select the sound output source with **PIP-SOUND** button on the remote controller.

Please check the following items before calling for the repair services.

Problem	Check item	Reference page
TV set		
Control/System lock up	<ul style="list-style-type: none"> The TV may have malfunctioned. Switch your TV off and on again with the main ϕ /OFF button on the TV set. 	- 16
Remote control does not work.	<ul style="list-style-type: none"> Perform control/system lock up reset (as above) Replace the batteries in the remote controller. Make sure the Remote sensor window is not under strong light e.g. a fluorescent lamps. 	6 -
Local buttons do not work.	<ul style="list-style-type: none"> Has the Child lock been switched on? 	20
No picture and no sound.	<ul style="list-style-type: none"> Check that the TV set is switched on at the main ϕ /OFF switch. 	16
No picture.	<ul style="list-style-type: none"> Make sure the brightness and contrast are not set to minimum. 	17
No colour	<ul style="list-style-type: none"> Make sure the Colour is not set to minimum. Check the Colour standard settings. 	17 15
Picture is too light or too dark.	<ul style="list-style-type: none"> Adjust the Brightness, Contrast. 	17
The picture is improperly tinted.	<ul style="list-style-type: none"> Adjust the Colour temperature. Check the Tint adjustment (NTSC signal) 	20 17
No sound.	<ul style="list-style-type: none"> Check that the volume is not set to minimum. Check sound is not muted. Make sure headphones are not connected. 	19 19 10
Aerial		
The picture is not sharp. The picture shakes.	<ul style="list-style-type: none"> Reception may be weak. The quality of the broadcast may also be poor. Make sure the aerial is facing the correct direction. Check that the outside aerial is not disconnected. 	
The picture is ghosted.	<ul style="list-style-type: none"> Mountains or high buildings can cause double pictures. Try changing the direction of the aerial. 	
The picture is spotted(snow).	<ul style="list-style-type: none"> There may be interference from automobiles, trains, high voltage lines, neon lights, etc. There may be interference between the aerial cable and power cable. Try positioning cables further apart. 	
Picture has lines and faded colours.	<ul style="list-style-type: none"> Transmission aerial of amateur radios and cellular phones may cause interference. Position the TV set as far away as possible from devices that may cause interference. 	
PC		
Poor image	<ul style="list-style-type: none"> Adjust the Phase and Frequency. 	23
Image is not centered on screen	<ul style="list-style-type: none"> Adjust the Horizontal and vertical position. 	23

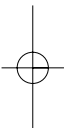

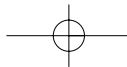

Wall/Arm Mounting

Attaching a Wall or Arm mounting device

This TV supports the VESA mounting standard and will accommodate various VESA mounting devices. To install any VESA mounting device, please follow the manufacturer's instructions.

1. Remove all cables connected to the TV.
2. Lay the LCD TV face-down on a flat surface with a blanket or other soft materials to protect the screen.
3. Remove the four screws attaching the stand. Remove stand from LCD TV.
4. Now you are ready to install the VESA mounting device suited to your applications (see instructions below).
5. Connect all cables removed at step 1.

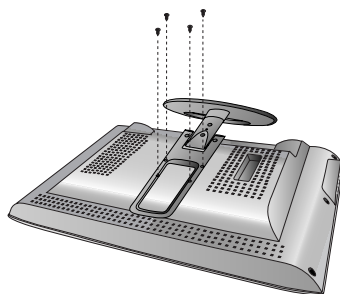

Installing VESA compliant mounting devices

1. Align the mounting interface pad (100mm x 100mm hole spacing) with the holes in the televisions rear cover mounting pad.
2. Secure bracket with the four screws (4mmØ) that came with the VESA mounting device.

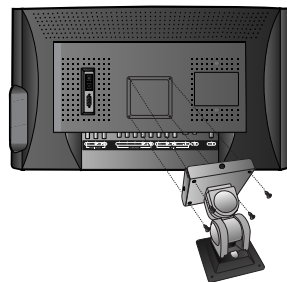

Product Specifications

ENGLISH

Model No.	DSL-15D1T	DSL-17W1T
Display		
Lamp type	CCFL	
Lamp life time	50,000 Hrs	
Panel type	15" 4:3 aspect ratio TFT LCD	17" 16:9 aspect ratio TFT LCD
Pixel resolution	2,359,296 dots (1024xRGBx768,XGA)	2,949,120 dots (1280xRGBx768,WXGA)
Brightness	400 cd/m ² , 500 cd/m ² (CMO)	450 cd/m ²
Viewing angle	120V/140H,100V/120H(CMO)	120V/140H, 176V/176H(IPS)
Mains		
Mains voltage	100-240V AC, 50/60Hz	
AC Adapter output	12V DC	
Power consumption	◇ Stand-by : 5W max ◇ Power saving : 11W max ◇ Operating : 46W max	◇ Stand-by : 5W max ◇ Power saving : 11W max ◇ Operating : 46W max
TV standards		
TV standards	PAL-BG/DK/I SECAM-BG/DK/L NTSC (AV ONLY)	
Sound system	A2-BG/DK NICAM-BG/DK/I/L	
Reception channel	◇ VHF : E2(48.25)-E4(62.25), E5(175.25)-E12(224.25) ◇ UHF : E21(471.25)-E69(855.25) ◇ Cable : S1'(69.25)-S3'(83.25), S1(105.25)- S41(463.25)	
Sound		
Sound output	2 W x 2	
Loudspeaker	3 W max	
Teletext (Option)		
Fasttext	10 pages memory TOP/FLOF	
Teletext language	Pan-European, Cyrillic, Greek/Turkish, Arabic /French (Option)	
Connections		
Terminals	◇ RF(DIN): 75 ohm	
	◇ Video in /out (AV, SCART): 1.0 Vp-p @ 75 ohm	
	◇ Audio in / out (AV, SCART, PC Audio): 0.5Vrms	
	◇ Y in (S-video, Component): 1.0 Vp-p @ 75 ohm	
	◇ C in (S-Video): 0.3 Vp-p @ 75 ohm	
	◇ R,G,B in (SCART, Component, D-sub) : 0.7 Vp-p @ 75 ohm	
◇ Pb, Pr in (Component) : 0.7 Vp-p @ 75 ohm		
◇ Audio out (Headphone)		
Mechanical spec.		
Net Dimension (WxHxD mm)	DSL-15D1T - With stand : 484x360x185 - W/O stand : 484x303x60	DSL-17W1T - With stand : 532x352x185 - W/O stand : 532x297x58
Net Weight (Kg)	DSL-15D1T - With stand : 5.8 - W/O stand : 4.3	DSL-17W1T -With stand : 6.6 -W/O stand : 4.8
Table stand	Tilt : 5° forward, 15° backward Swivel: 45°	Tilt : 5° forward, 15° backward Swivel: 45°
Wall mounting	VESA compatible	

* Owing to our policy of continuous improvement, specifications may change.

HELP NUMBER 0870 100 2525

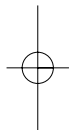
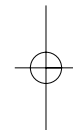



memo

