

(CNY17-2)

- AC LINE /DIGITAL LOGIC ISOLATOR
- DIGITAL LOGIC /DIGITAL LOGIC ISOLATOR
- TELEPHONE LINE RECEIVER
- TWISTED PAIR LINE RECEIVER
- HIGH FREQUENCY POWER SUPPLY FEEDBACK CONTROL
- RELAY CONTACT MONITOR

The TOSHIBA Corporation CNY17 consist of a gallium arsenide infrared emitting diode coupled with a silicon photo transistor in a dual in-line package.

- Small Package Size and Low Cost
- Fast Switching Speeds :  $5\mu s$
- High DC Current Transfer Ratio : CTR ( $I_F = 10mA, V_{CE} = 5V$ )  
 CNY17-2 : 63~125%  
 CNY17-3 : 100~200%  
 CNY17-4 : 160~320%
- High Isolation Resistance :  $10^{11}\Omega$
- High Isolation Voltage : 4400V

Unit in mm

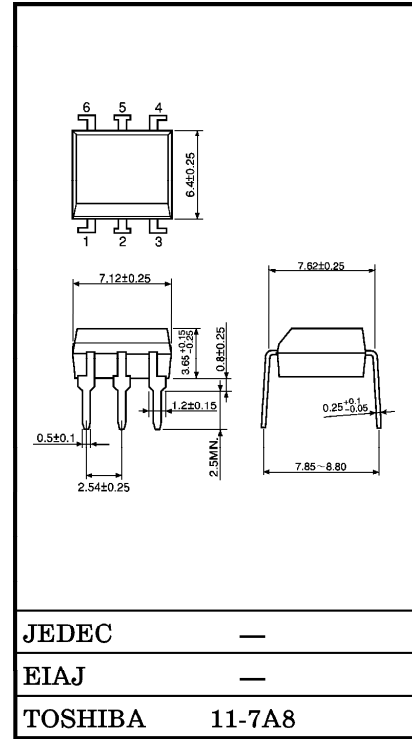

Weight : 0.4g

PIN CONFIGURATION

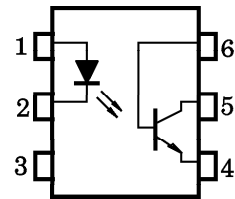

- 1 : ANODE
- 2 : CATHODE
- 3 : N.C.
- 4 : EMITTER
- 5 : COLLECTOR
- 6 : BASE

© The information contained herein is presented only as a guide for the applications of our products. No responsibility is assumed by TOSHIBA CORPORATION for any infringements of intellectual property or other rights of the third parties which may result from its use. No license is granted by implication or otherwise under any intellectual property or other rights of TOSHIBA CORPORATION or others.

© These TOSHIBA products are intended for use in general commercial applications (office equipment, communication equipment, measuring equipment, domestic appliances, etc.). please make sure that you consult with us before you use these TOSHIBA products in equipment which requires extraordinarily high quality and/or reliability, and in equipment which may involve life threatening or critical application, including but not limited to such uses as atomic energy control, airplane or spaceship instrumentation, traffic signals, medical instrumentation, combustion control, all types of safety devices, etc. TOSHIBA cannot accept and hereby disclaims liability for any damage which may occur in case the TOSHIBA products are used in such equipment or applications without prior consultation with TOSHIBA.

①

(CNY17-2)

MAXIMUM RATINGS (Ta = 25°C)

CHARACTERISTIC		SYMBOL	RATING	UNIT
LED	Forward Current	I <sub>F</sub>	60	mA
	Forward Current Derating	ΔI <sub>F</sub> /°C	0.8*	mA/°C
	Peak Forward Current (Note)	I <sub>PF</sub>	3	A
	Power Dissipation	P <sub>D</sub>	100	mW
	Power Dissipation Derating	ΔP <sub>D</sub> /°C	1.33*	mW/°C
	Reverse Voltage	V <sub>R</sub>	6	V
PHOTO-TRANSISTOR	Collector-Emitter Voltage	BV <sub>CEO</sub>	70	V
	Collector-Base Voltage	BV <sub>CBO</sub>	70	V
	Emitter-Collector Voltage	BV <sub>ECO</sub>	7	V
	Collector Current	I <sub>C</sub>	100	mA
	Power Dissipation	P <sub>C</sub>	150	mW
	Power Dissipation Derating	ΔP <sub>C</sub> /°C	2.0*	mW/°C
COUPLED LED	Storage Temperature	T <sub>stg</sub>	-55~150	°C
	Operating Temperature	T <sub>opr</sub>	-55~100	°C
	Lead Soldering Temperature (10s)	T <sub>sol</sub>	260	°C
	Total Package Dissipation	P <sub>T</sub>	200	mW
	Total Package Power Dissipation Derating	ΔP <sub>T</sub> /°C	2.6*	mW/°C

Note : Pulse Width 1μs, 300pps.

\* Above 25°C ambient.

(CNY17-2)

ELECTRICAL CHARACTERISTICS (Ta = 25°C)

CHARACTERISTIC		SYMBOL	TEST CONDITION	MIN.	TYP.	MAX.	UNIT	
LED	Forward Voltage	$V_F$	$I_F = 60\text{mA}$	—	1.35	1.65	V	
	Reverse Current	$I_R$	$V_R = 3\text{V}$	—	—	10	$\mu\text{A}$	
	Capacitance	$C_D$	$V = 0, f = 1\text{MHz}$	—	30	—	pF	
PHOTO-TRANSISTOR	DC Forward Current Gain	$h_{FE}$	$V_{CE} = 5, I_C = 500\mu\text{A}$	100	200	—		
	Collector-Emitter Breakdown Voltage	$V_{(BR)CEO}$	$I_C = 1\text{mA}, I_F = 0$	70	—	—	V	
	Collector-Base Breakdown Voltage	$V_{(BR)CBO}$	$I_C = 100\mu\text{A}, I_F = 0$	70	—	—	V	
	Emitter-Collector Breakdown Voltage	$V_{(BR)ECO}$	$I_E = 100\mu\text{A}, I_F = 0$	7	—	—	V	
	Collector Dark Current	$I_{CEO}$	$V_{CE} = 10\text{V}, I_F = 0$	—	1	50	nA	
	Collector Dark Current	$I_{CBO}$	$V_{CB} = 10\text{V}, I_F = 0$	—	0.1	20	nA	
	Collector-Emitter Capacitance	$C_{CE}$	$V = 0, f = 1\text{MHz}$	—	10	—	pF	
COUPLED	Current Transfer Ratio	CNY17-2	$I_F = 10\text{mA}, V_{CE} = 5\text{V}$	63	—	125	%	
		CNY17-3		CTR	100	—		200
		CNY17-4		160	—	320		
	Saturation Voltage	$V_{CE(sat)}$	$I_F = 10\text{mA}, I_C = 2.5\text{mA}$	—	—	0.4	V	
	Capacitance Input to Output	$C_S$	$V = 0, f = 1\text{MHz}$	—	0.8	—	pF	
	Isolation Resistance	$R_S$	$V = 500\text{V}$	—	$10^{11}$	—	$\Omega$	
	DC Isolation Voltage	$BV_S$	DC 1 minute	4400	—	—	V	
	Rise / Fall Time Photo Diode	$t_r / t_f$	$V_{CE} = 10\text{V}, I_C = 2\text{mA}$ $R_L = 100\Omega$	—	5	10	$\mu\text{s}$	
Rise / Fall Time Photo Diode	$t_r / t_f$	$V_{CB} = 10\text{V}, I_{CB} = 50\mu\text{A}$ $R_L = 100\Omega$	—	200	—	ns		

CNY17-2 - 3

1996 - 4 - 8

**TOSHIBA CORPORATION**

(CNY17-2)

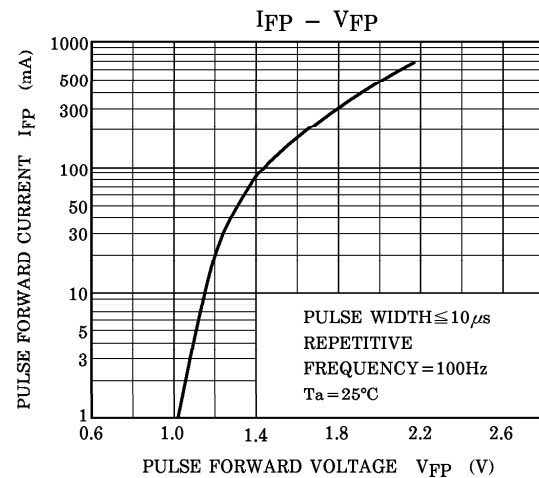
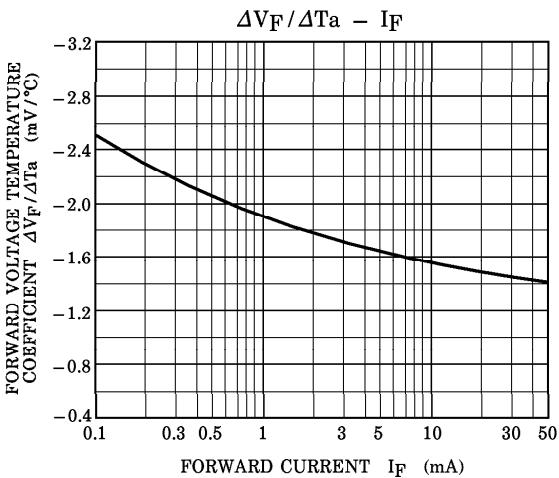
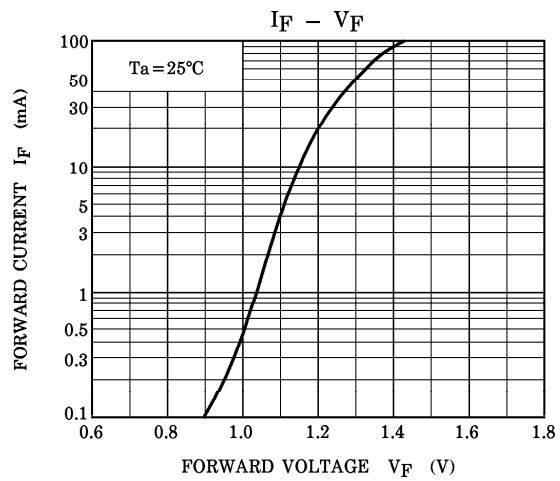
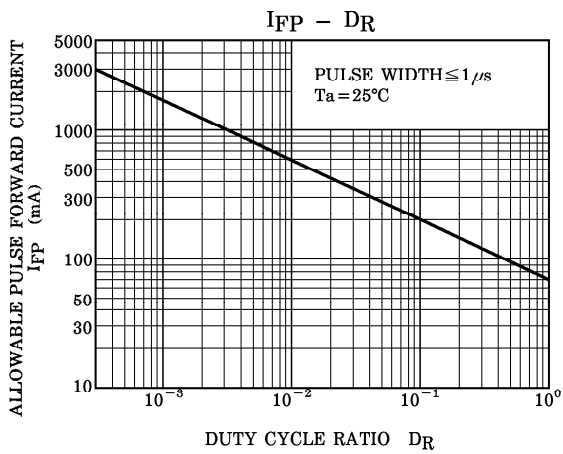
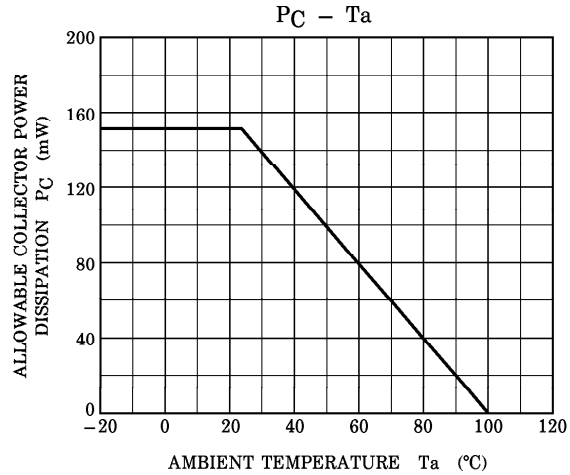
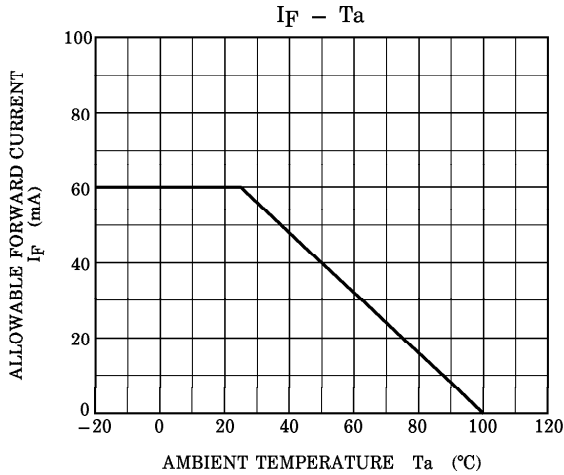

(CNY17-2)

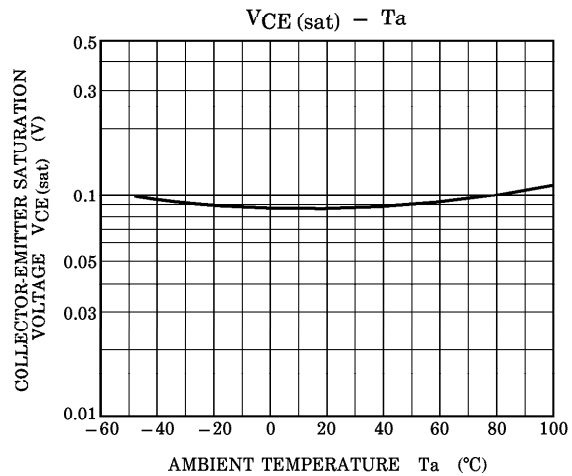
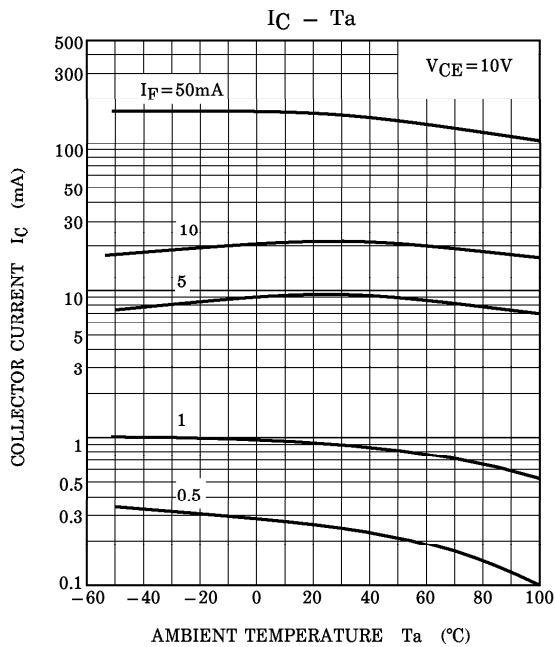
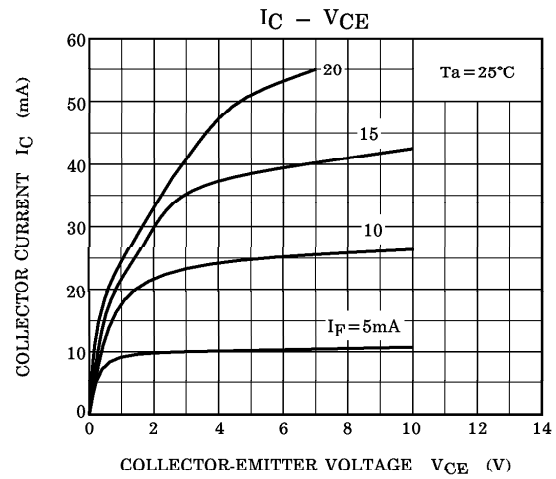
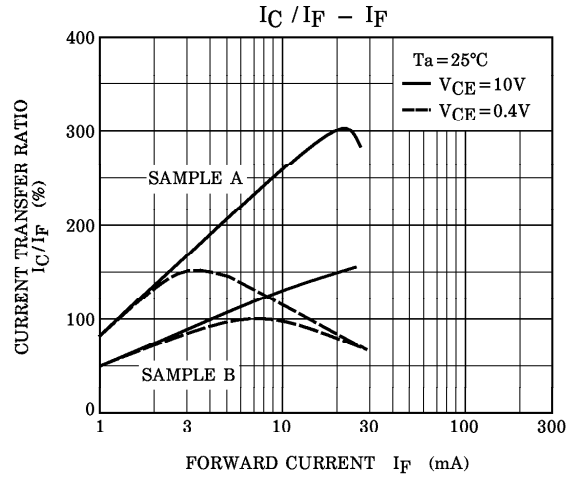
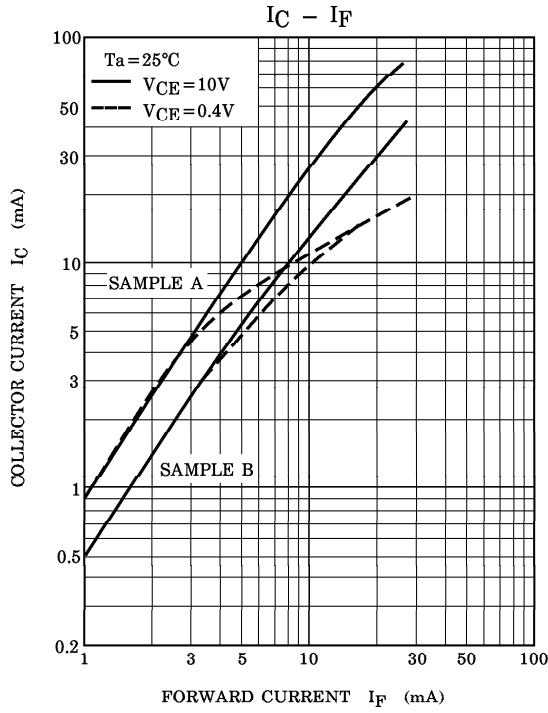

(CNY17-2)

