

7 W Ka Band Packaged Power Amplifier

TGA4915-EPU-CP



Key Features and Performance

- Frequency Range: 26 - 31 GHz
- 38 dBm Typical Psat @ Pin =21 dBm
- 22 dB Nominal Gain
- 15 dB Typical Return Loss
- 0.25µm pHEMT Technology
- Bias Conditions: Vd = 6V, Idq = 4.2 A
- Package Dimensions: 0.526 x 0.650 x 0.073 in

Primary Applications

- Satellite Ground Terminals
- Point to Point

Product Description

The TriQuint TGA4915-EPU-CP is a compact 7 Watt High Power Amplifier for Ka band applications. The part is designed using TriQuint's proven standard 0.25 um gate Power pHEMT production process.

The TGA4915 provides a nominal 38 dBm of output power at an input power level of 21 dBm with a small signal gain of 22 dB.

The part is ideally suited for low cost emerging markets such as base station transmitters for satellite ground terminals and point to point radio.

Preliminary Measured Performance

Bias Conditions: Vd=6 V Idq=4.2 A

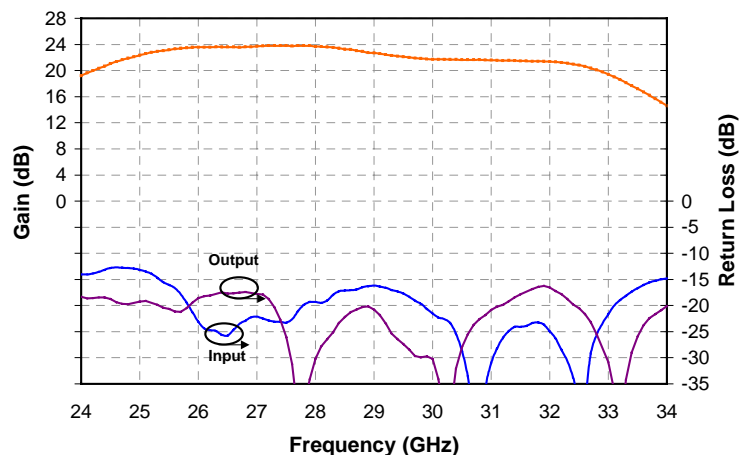
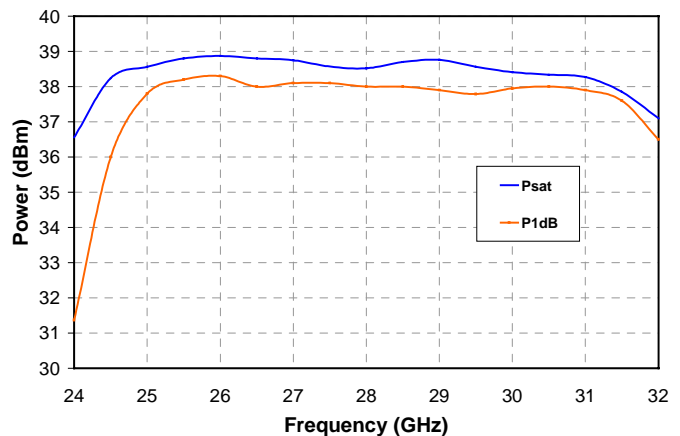

Note: Devices designated as EPU are typically early in their characterization process prior to finalizing all electrical and process specifications. Specifications are subject to change without notice.

**TABLE I
MAXIMUM RATINGS**

Symbol	Parameter <u>1/</u>	Value	Notes
V ⁺	Positive Supply Voltage	8 V	<u>2/</u>
V ⁻	Negative Supply Voltage Range	-3V TO 0V	
I ⁺	Positive Supply Current (Quiescent)	8 A	<u>2/</u>
I _G	Gate Supply Current	124 mA	
P _{IN}	Input Continuous Wave Power	27 dBm	<u>2/</u>
P _D	Power Dissipation	34 W	<u>2/</u> , <u>3/</u>
T _{CH}	Operating Channel Temperature	150 °C	<u>4/</u> , <u>5/</u>
T _M	Mounting Temperature (30 Seconds)	210 °C	
T _{STG}	Storage Temperature	-65 to 150 °C	

- 1/ These ratings represent the maximum operable values for this device.
- 2/ Combinations of supply voltage, supply current, input power, and output power shall not exceed P_D.
- 3/ P_D is the power dissipation allowed in order to reach a channel temperature of 150°C with a package base temperature of 70°C. When operated at this power dissipation with a baseplate temperature of 70°C, the MTTF is 1.0E+6 hours.
- 4/ These ratings apply to each individual FET.
- 5/ Junction operating temperature will directly affect the device median time to failure (T_M). For maximum life, it is recommended that junction temperatures be maintained at the lowest possible levels.

Note: Devices designated as EPU are typically early in their characterization process prior to finalizing all electrical and process specifications. Specifications are subject to change without notice.

TABLE II
RF CHARACTERIZATION TABLE
($T_A = 25\text{ }^\circ\text{C}$, Nominal)
($V_d = 6\text{ V}$, $I_d = 4.2\text{ A}$)

SYMBOL	PARAMETER	TEST CONDITION	TYPICAL	UNITS
Gain	Small Signal Gain	F = 26-31 GHz	22	dB
IRL	Input Return Loss	F = 26-31 GHz	15	dB
ORL	Output Return Loss	F = 26-31 GHz	15	dB
PWR	Output Power @ P1dB	F = 26-31 GHz	38	dBm

TABLE III
THERMAL INFORMATION*

Parameter	Test Conditions	T_{CH} ($^\circ\text{C}$)	$R_{\theta JC}$ ($^\circ\text{C/W}$)	T_M (hrs)
$R_{\theta JC}$ Thermal Resistance (Channel to Backside of Package)	$V_D = 6\text{ V}$ $I_D = 4.2\text{ A}$ $P_{DISS} = 25.2\text{ W}$	128	2.3	7.4 E+6

Note: Carrier at $70\text{ }^\circ\text{C}$ baseplate temperature. Worst case is at saturated output power when DC power consumption rises to 44 W with 7 W RF power delivered to the load. Power dissipated is 37 W and the temperature rise in the channel is $85\text{ }^\circ\text{C}$. Baseplate temperature must be reduced to $65\text{ }^\circ\text{C}$ to remain below the $150\text{ }^\circ\text{C}$ maximum channel temperature.

Note: Devices designated as EPU are typically early in their characterization process prior to finalizing all electrical and process specifications. Specifications are subject to change without notice.

Measured Fixtured Data
Bias Conditions: $V_d = 6\text{ V}$, $I_d = 4.2\text{ A}$

TGA4915-EPU-CP

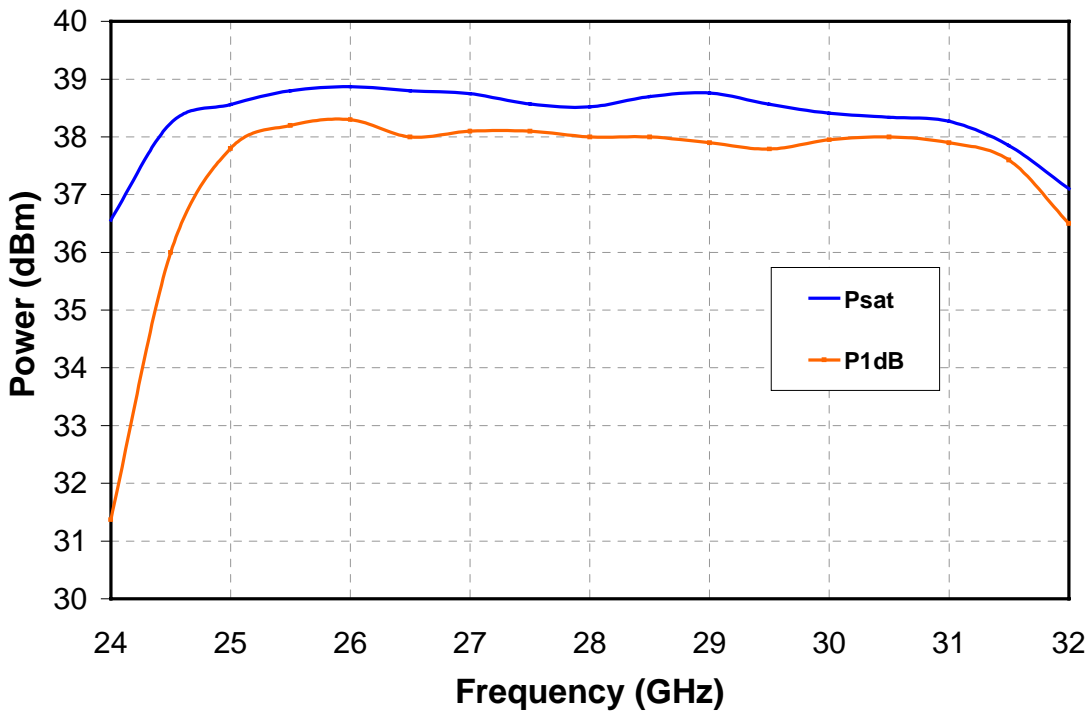
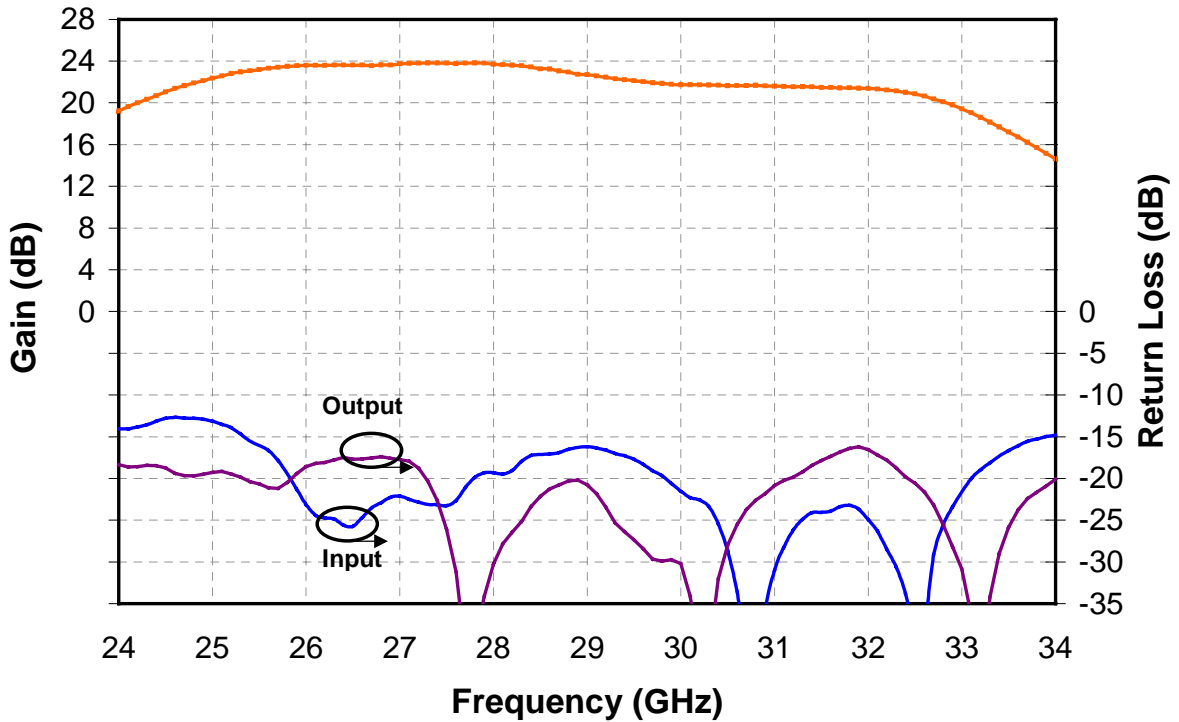

Note: Devices designated as EPU are typically early in their characterization process prior to finalizing all electrical and process specifications. Specifications are subject to change without notice.

Measured Fixtured Data

Bias Conditions: $V_d = 6\text{ V}$, $I_d = 4.2\text{ A}$

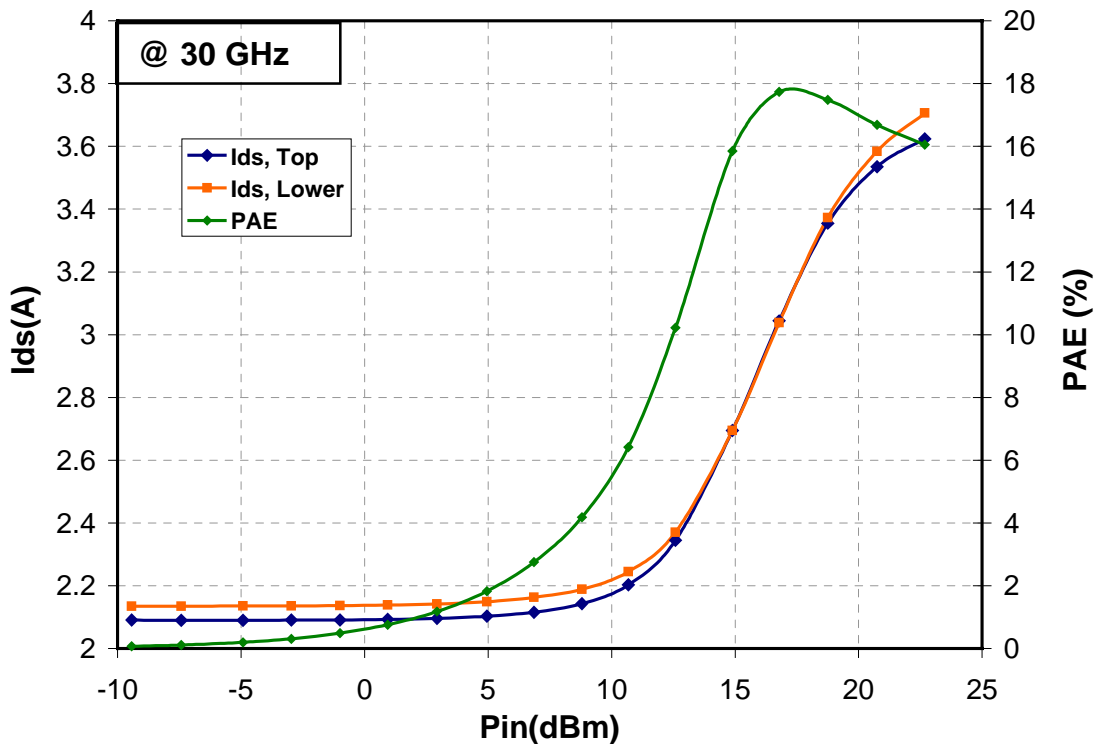
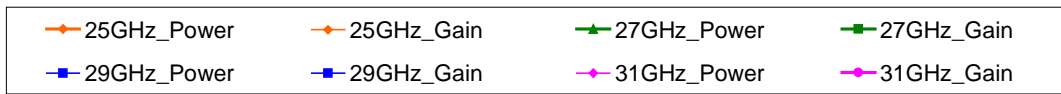
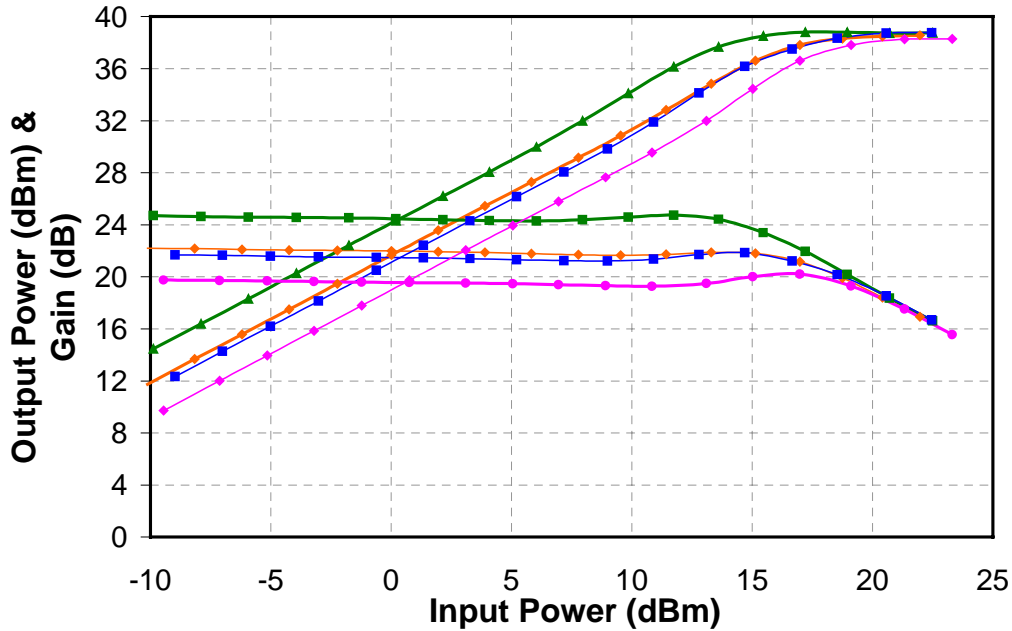

Note: Devices designated as EPU are typically early in their characterization process prior to finalizing all electrical and process specifications. Specifications are subject to change without notice.

Package Pinout Diagram

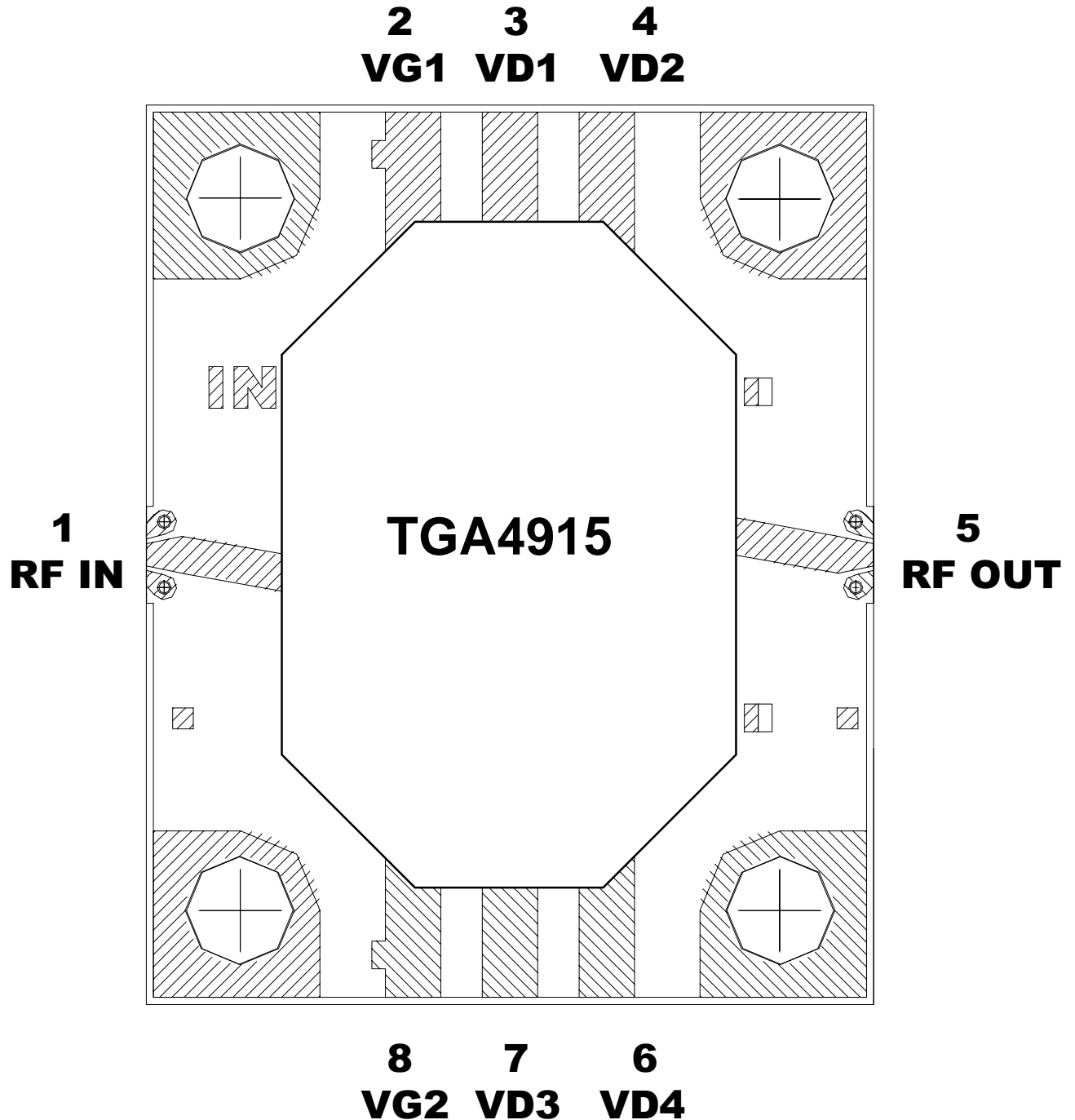

GaAs MMIC devices are susceptible to damage from Electrostatic Discharge. Proper precautions should be observed during handling, assembly and test.

Note: Devices designated as EPU are typically early in their characterization process prior to finalizing all electrical and process specifications. Specifications are subject to change without notice.

Mechanical Drawing

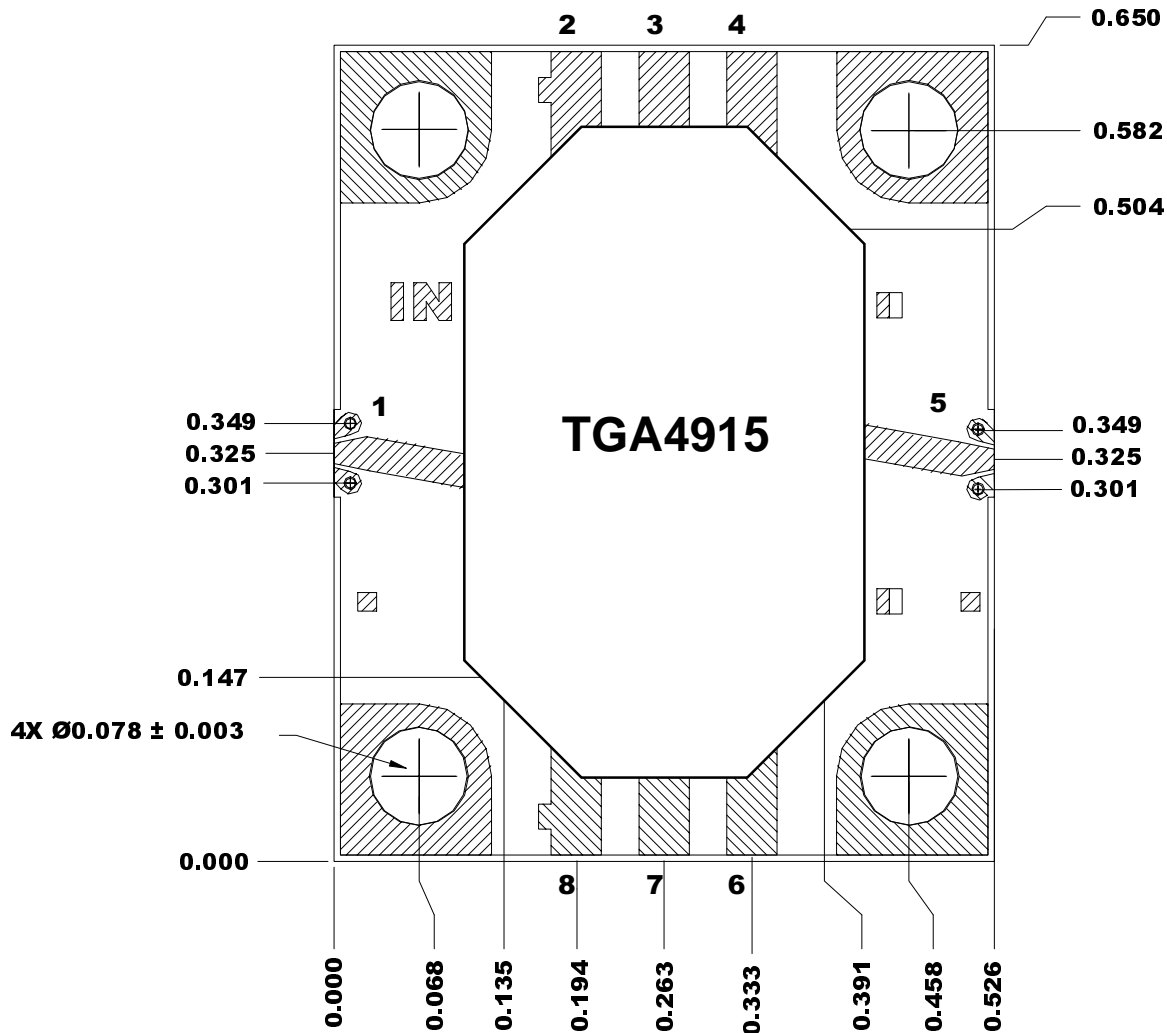

Side View

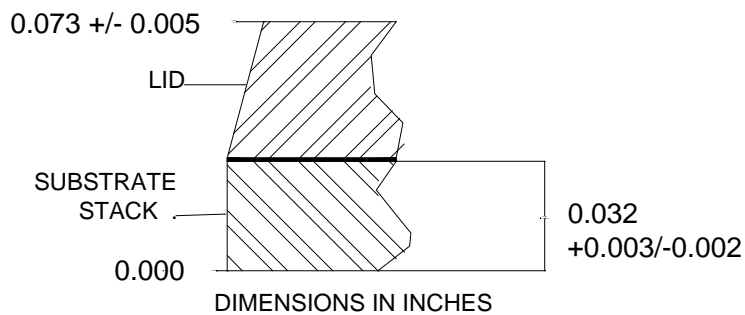

GaAs MMIC devices are susceptible to damage from Electrostatic Discharge. Proper precautions should be observed during handling, assembly and test.

Note: Devices designated as EPU are typically early in their characterization process prior to finalizing all electrical and process specifications. Specifications are subject to change without notice.

Assembly of a TGA4915-EPU-CP into a Module

Manual Assembly for Prototypes

1. Clean the module with Acetone. Rinse with alcohol and DI water. Allow the module to fully dry.
2. To improve the thermal and RF performance, we recommend attaching a heatsink to the bottom of the package. If the TGA4915 is mounted to the heatsink with mounting screws, we recommend an indium shim or other compliant material be inserted between the TGA4915 and the heatsink to reduce thermal contact resistance due to air gaps. The TGA4915 may also be attached to the heatsink using SN63 solder or any other Tin/Lead solder. The TGA4915 may also be mounted with DieMat DM6030HK conductive epoxy or similar thermally and electrically conductive epoxy.
3. The DC and RF interconnects may be gold bondwires or gold ribbons. The RF interconnects should be as short as possible. A minimum of two 1 mil wires are recommended for the RF Input, RF Output, Vg, and Vd1 and Vd3. Six bondwires are recommended for Vd2 and Vd4.

ORDERING INFORMATION

PART	PACKAGE STYLE
TGA4915-EPU-CP	CARRIER PLATE

Note: Devices designated as EPU are typically early in their characterization process prior to finalizing all electrical and process specifications. Specifications are subject to change without notice.