

FG1000BV-90DA

HIGH POWER INVERTER USE
PRESS PACK TYPE

FG1000BV-90DA



- ITQRM Repetitive controllable on-state current 1000A
- IT(AV) Average on-state current 400A
- VDRM Repetitive peak off state voltage 4500V
- Anode short type

OUTLINE DRAWING

Dimensions in mm

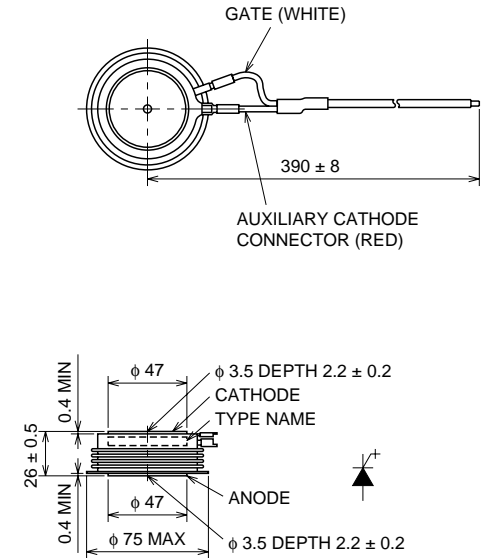

APPLICATION

Inverters, D.C. choppers, Induction heaters, D.C. to D.C. converters.

MAXIMUM RATINGS

Symbol	Parameter	Voltage class		Unit
		90DA		
VRRM	Repetitive peak reverse voltage	17		V
VRSM	Non-repetitive peak reverse voltage	17		V
VR(DC)	DC reverse voltage	17		V
VDRM	Repetitive peak off-state voltage*	4500		V
VD(SM)	Non-repetitive peak off-state voltage*	4500		V
VD(DC)	DC off-state voltage*	3600		V

* : VGK = -2V

Symbol	Parameter	Conditions	Ratings	Unit
ITQRM	Repetitive controllable on-state current	V _{DM} = 3375V, T _J = 125°C, C _S = 0.7μF, L _S = 0.3μH	1000	A
IT(RMS)	RMS on-state current		630	A
IT(AV)	Average on-state current	f = 60Hz, sine wave θ = 180°, T _r = 70°C	400	A
ITSM	Surge (non-repetitive) on-state current	One half cycle at 60Hz	8.4	kA
I ² t	Current-squared, time integration	One cycle at 60Hz	2.9 × 10 ⁵	A ² s
diT/dt	Critical rate of rise of on-state current	V _D = 2250V, I _{GM} = 20A, T _J = 125°C	1000	A/μs
VFGM	Peak forward gate voltage		10	V
VRGM	Peak reverse gate voltage		17	V
IFGM	Peak forward gate current		60	A
IRGM	Peak gate reverse current		500	A
PFGM	Peak forward gate power dissipation		240	W
PRGM	Peak reverse gate power dissipation		15	kW
PFG(AV)	Average forward gate power dissipation		45	W
PRG(AV)	Average reverse gate power dissipation		100	W
T _J	Junction temperature		-40 ~ +125	°C
T _{stg}	Storage temperature		-40 ~ +150	°C
—	Mounting force required	Recommended value 13	12 ~ 15	kN
—	Weight	Standard value	530	g

FG1000BV-90DA

HIGH POWER INVERTER USE
PRESS PACK TYPE

ELECTRICAL CHARACTERISTICS

Symbol	Parameter	Test conditions	Limits			Unit
			Min	Typ	Max	
V _{TM}	On-state voltage	T _j = 125°C, I _{TM} = 1000A, Instantaneous measurement	—	—	4.0	V
I _{RRM}	Repetitive peak reverse current	T _j = 125°C, V _{RRM} Applied	—	—	100	mA
I _{DRM}	Repetitive peak off-state current	T _j = 125°C, V _{DRM} Applied, V _{GK} = -2V	—	—	100	mA
I _{RG}	Reverse gate current	T _j = 125°C, V _{RG} = 17V	—	—	100	mA
dv/dt	Critical rate of rise of off-state voltage	T _j = 125°C, V _D = 2250V, V _{GK} = -2V	1000	—	—	V/μs
t _{gt}	Turn-on time	T _j = 125°C, I _{TM} = 1000A, I _{GM} = 20A, V _D = 2250V	—	—	10	μs
t _{gq}	Turn-off time	T _j = 125°C, I _{TM} = 1000A, V _{DM} = 3375V, diGQ/dt = -30A/μs V _{RG} = 17V, C _s = 0.7μF, L _s = 0.3μH	—	—	20	μs
I _{GQM}	Peak gate turn-off current		—	330	—	A
V _{GT}	Gate trigger voltage	DC METHOD : V _D = 24V, R _L = 0.1Ω, T _j = 25°C	—	—	1.5	V
I _{GT}	Gate trigger current		—	—	2500	mA
R _{th(j-f)}	Thermal resistance	Junction to fin	—	—	0.03	°C/W

PERFORMANCE CURVES

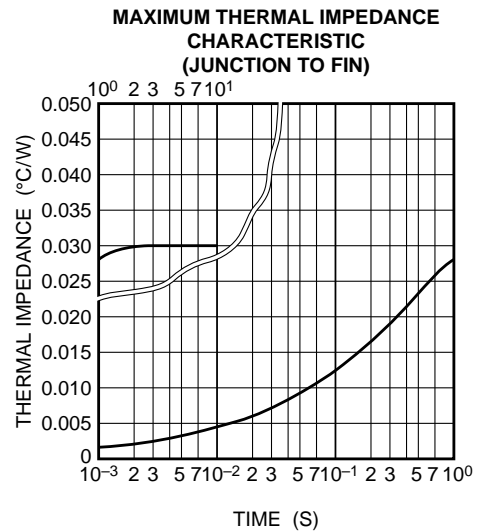
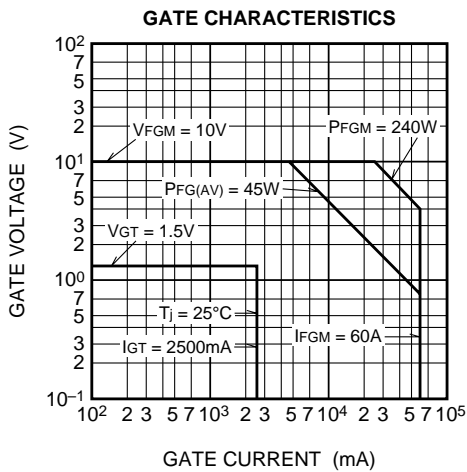
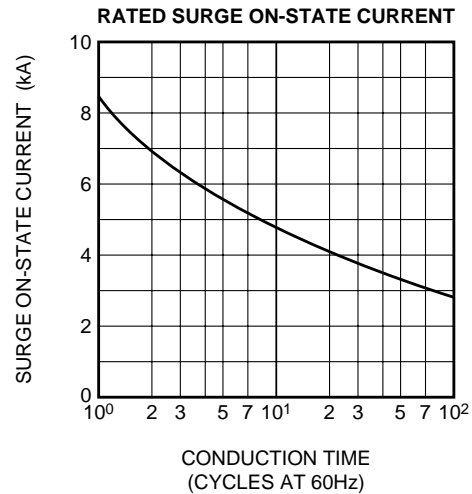
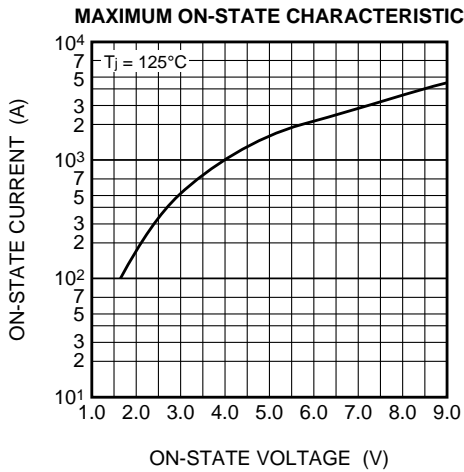

FG1000BV-90DA

HIGH POWER INVERTER USE
PRESS PACK TYPE

MAXIMUM ON-STATE POWER DISSIPATION CHARACTERISTICS (SINGLE-PHASE HALF WAVE)

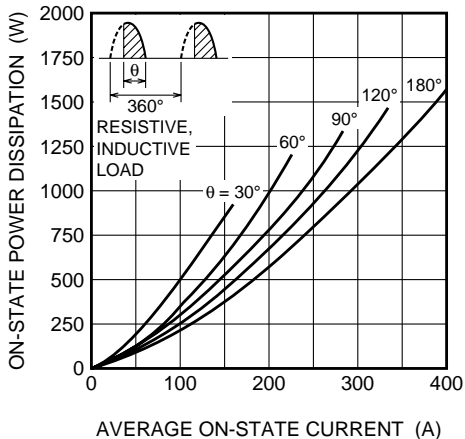

ALLOWABLE FIN TEMPERATURE VS. AVERAGE ON-STATE CURRENT (SINGLE-PHASE HALF WAVE)

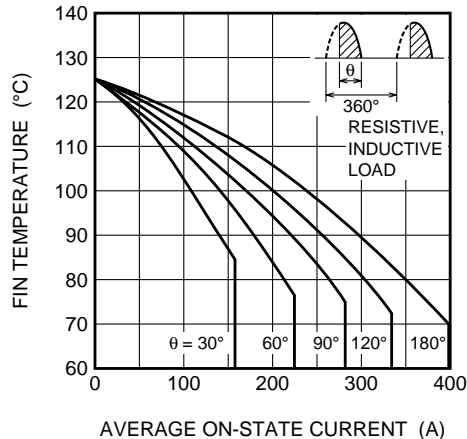

MAXIMUM ON-STATE POWER DISSIPATION CHARACTERISTICS (RECTANGULAR WAVE)

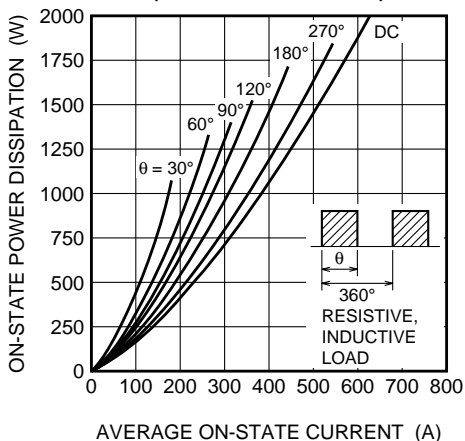

ALLOWABLE FIN TEMPERATURE VS. AVERAGE ON-STATE CURRENT (RECTANGULAR WAVE)

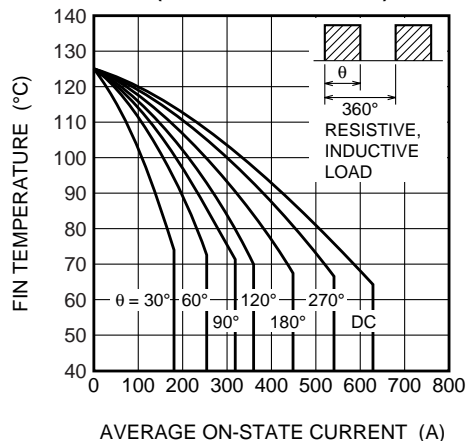

GATE TRIGGER CURRENT VS. JUNCTION TEMPERATURE (TYPICAL)

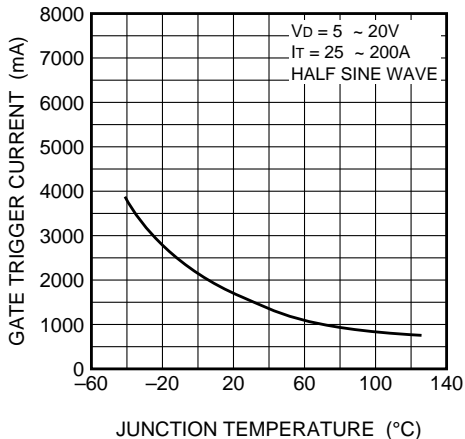

TURN ON TIME, TURN ON DELAY TIME VS. TURN ON GATE CURRENT (TYPICAL)

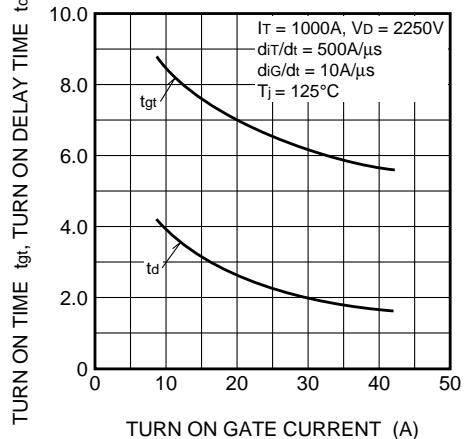

FG1000BV-90DA

HIGH POWER INVERTER USE
PRESS PACK TYPE

