



Dual, 3mm x 3mm, 1.2A/Programmable-Current USB Switches with Autoreset

MAX1558/MAX1558H

General Description

The MAX1558/MAX1558H are dual, current-limited switches with autoreset for USB applications. Autoreset latches the switch off if it is shorted for more than 20ms, saving system power. The shorted output is then tested to determine when the short is removed to automatically restart the channel. Each channel delivers up to 1.2A and meets all IEC specifications for USB ports. Low quiescent supply current (45µA) and standby current (3µA) conserve battery power in portable applications.

The MAX1558/MAX1558H safety features ensure that the USB port is protected. Built-in thermal-overload protection limits power dissipation and junction temperature. Accurate, programmable current-limiting circuitry protects the input supply against both overload and short-circuit conditions. 20ms fault blanking enables the circuit to ignore transient faults, such as those caused when hot swapping a capacitive load, preventing false alarms to the host system. The MAX1558/MAX1558H also feature reverse-current protection circuitry to block current flow from the output to the input when the switches are off.

The MAX1558/MAX1558H are available in space-saving 3mm x 3mm, 10-pin TDFN packages. The MAX1558 is enabled with an active-low signal, and the MAX1558H is enabled with an active-high signal.

Applications

- USB Ports and Hubs
- Notebook Computers and Desktops
- PDA's and Palmtop Computers
- Docking Stations

Pin Configuration

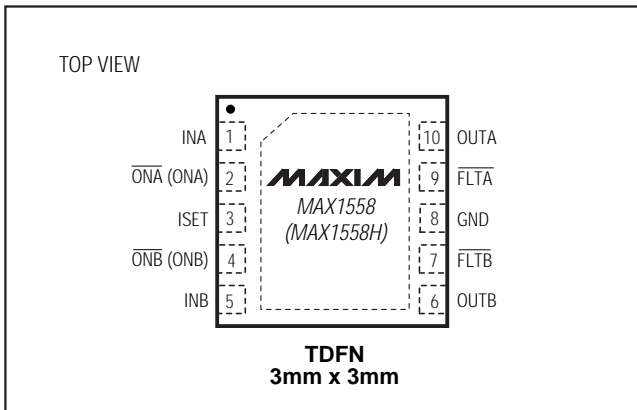

Features

- ◆ 55mΩ Switch Resistance
- ◆ Tiny 10-Pin, 3mm x 3mm TDFN Package
- ◆ 14% Accurate Current Limit
- ◆ Autoreset when Fault is Removed
- ◆ Programmable Current Up to 1.2A
- ◆ Thermal-Overload Protection
- ◆ Built-In 20ms Fault Blanking
- ◆ Compliant to All USB Specifications
- ◆ 2.7V to 5.5V Supply Range
- ◆ Independent-Output Fault Indicators
- ◆ Block Reverse Current when Disabled
- ◆ 15kV ESD Protection (with Capacitor)
- ◆ UL Listing Pending

Ordering Information

PART	TEMP RANGE	PIN-PACKAGE	TOP MARK
MAX1558ETB	-40°C to +85°C	10 TDFN (3mm x 3mm)	AAR
MAX1558HETB	-40°C to +85°C	10 TDFN (3mm x 3mm)	AAS

Typical Operating Circuit

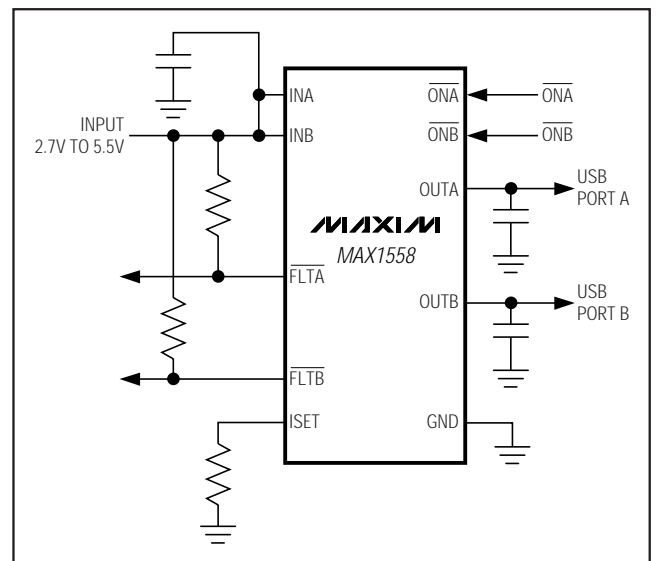

Dual, 3mm x 3mm, 1.2A/Programmable-Current USB Switches with Autoreset

ABSOLUTE MAXIMUM RATINGS

IN ₋ , ON ₋ , OUT ₋ , ISET, $\overline{\text{FLT}}_{-}$ to GND.....	-0.3V to +6V	Continuous Power Dissipation (T _A = +70°C) 10-Pin TDFN 3mm x 3mm (derate 24.4mW/°C above +70°C).....	1952mW
IN ₋ to OUT ₋ (when disabled) (Note 1)	-6V to +6V	Operating Temperature Range	-40°C to +85°C
IN ₋ to OUT ₋ (when enabled) (Note 2)	-1.6A to +1.6A _{RMS}	Junction Temperature	+160°C
$\overline{\text{FLT}}_{-}$ Sink Current.....	20mA	Storage Temperature Range	-65°C to +150°C
		Lead Temperature (soldering, 10s)	+300°C

Note 1: Reverse current (current from OUT₋ to IN₋) is blocked when disabled.

Note 2: Forward current (current from IN₋ to OUT₋) is internally limited. Reverse current, from OUT₋ to IN₋, is not limited when the device is enabled and must be kept below 1.5A_{RMS} to prevent permanent device damage. When the MAX1558/MAX1558H are disabled, the switch turns off and reverse current is internally blocked.

Stresses beyond those listed under "Absolute Maximum Ratings" may cause permanent damage to the device. These are stress ratings only, and functional operation of the device at these or any other conditions beyond those indicated in the operational sections of the specifications is not implied. Exposure to absolute maximum rating conditions for extended periods may affect device reliability.

ELECTRICAL CHARACTERISTICS

(V_{INA} = V_{INB} = 5V, V_{ONA} = V_{ONB} = 0V (MAX1558), V_{ONA} = V_{ONB} = 5V (MAX1558H), R_{ISET} = 26kΩ to GND, T_A = 0°C to +85°C, unless otherwise noted. Typical values are at T_A = +25°C.) (Note 3)

PARAMETER	SYMBOL	CONDITIONS	MIN	TYP	MAX	UNITS	
Supply Voltage Range			2.75		5.50	V	
Switch On-Resistance	R _{ON}	V _{IN-} = 5V, T _A = +25°C		55	75	mΩ	
		V _{IN-} = 3.3V, T _A = +25°C		64			
		V _{IN-} = 4.4V, T _A = 0°C to +85°C			105		
Standby Supply Current		Both switches disabled		3	6	μA	
Quiescent Supply Current		Both switches enabled		45	75	μA	
OUT ₋ Off-Leakage Current		Switches disabled	V _{OUTA} = V _{OUTB} = 0V	0.03	10	μA	
			V _{OUTA} = V _{OUTB} = 5V	0.03			
Reverse Leakage Current		V _{IN-} = 0V, V _{OUTA} = V _{OUTB} = 5V, both switches disabled		0.03		μA	
Undervoltage-Lockout Threshold	V _{UVLO}	Rising edge, 3% hysteresis	2.3	2.5	2.7	V	
Continuous Load Current		R _{ISET} = 26kΩ	1.2			A	
Current-Limit Threshold		V _{IN-} - V _{OUT-} = 0.5V	R _{ISET} = 26kΩ	1.20	1.4	1.60	A
			R _{ISET} = 39kΩ	0.80	0.925	1.05	
			R _{ISET} = 60kΩ	0.50	0.6	0.70	
Peak Short-Circuit Current Limit	I _{SHORT}	V _{OUT-} = 0V (I _{OUT-} pulsing)	R _{ISET} = 26kΩ	1.45	2.0	2.60	A(PK)
			R _{ISET} = 39kΩ		1.40		
			R _{ISET} = 60kΩ		0.90		
RMS Short-Circuit Current Limit	I _{SHORT}	V _{OUT-} = 0V (I _{OUT-} pulsing)	R _{ISET} = 26kΩ		0.55	A _{RMS}	
			R _{ISET} = 39kΩ		0.37		
			R _{ISET} = 60kΩ		0.23		
Short-Circuit Continuous Current-Limit Transition Threshold		(Note 4)		1		V	
Fault-Blanking Timeout Period		From I _{LIMIT} condition to 50% of V _{FLT-}	8	20	40	ms	
Turn-On Delay	t _{ON}	R _{OUT-} = 10Ω, C _{OUT-} = 1μF, does not include rise time (from ON asserted to V _{OUT-} = 10% V _{IN-})	0.5	1.4	4.0	ms	

Dual, 3mm x 3mm, 1.2A/Programmable-Current USB Switches with Autoreset

MAX1558/MAX1558H

ELECTRICAL CHARACTERISTICS (continued)

($V_{INA} = V_{INB} = 5V$, $V_{\overline{ONA}} = V_{\overline{ONB}} = 0V$ (MAX1558), $V_{ONA} = V_{ONB} = 5V$ (MAX1558H), $R_{ISET} = 26k\Omega$ to GND, $T_A = 0^\circ C$ to $+85^\circ C$, unless otherwise noted. Typical values are at $T_A = +25^\circ C$.) (Note 3)

PARAMETER	SYMBOL	CONDITIONS	MIN	TYP	MAX	UNITS
Output Rise Time	t_{RISE}	$C_{OUT_} = 1\mu F$, $R_{OUT_} = 10\Omega$, (from 10% to 90% of $V_{OUT_}$)		4		ms
Turn-Off Delay from ON	t_{OFF}	$R_{OUT_} = 10\Omega$, $C_{OUT_} = 1\mu F$, does not include rise time (from ON deasserted to $V_{OUT_} = 90\% V_{IN_}$)		100	1000	μs
Output Fall Time	t_{FALL}	$C_{OUT_} = 1\mu F$, $R_{OUT_} = 10\Omega$ (from 90% to 10% of $V_{OUT_}$)		3		ms
Thermal-Shutdown Threshold		10°C hysteresis		+160		°C
ONA/ONB Logic Input High Voltage	V_{IH}	$V_{IN_} = 2.7V$ to $4.0V$	1.6			V
		$V_{IN_} = 4.0V$ to $5.5V$	2.0			
ONA/ONB Logic Input Low Voltage	V_{IL}	$V_{IN_} = 2.7V$ to $4.0V$			0.6	V
		$V_{IN_} = 4.0V$ to $5.5V$			0.8	
Logic Input Current		$V_{ON_} = 0V$ or $V_{IN_}$	-1		+1	μA
$\overline{FLT_}$ Output Low Voltage		$I_{SINK} = 1mA$			0.4	V
$\overline{FLT_}$ Output High Leakage Current		$V_{IN_} = V_{\overline{FLT_}} = 5.5V$			1	μA
Autorestart Current		In latched-off state, $V_{OUT_} = 0V$	10	25	50	mA
Autorestart Threshold		In latched-off state, rising	0.4	0.5	0.6	V
Autorestart Delay		In latched-off state, $V_{OUT_} > 1V$	8	20	40	ms

ELECTRICAL CHARACTERISTICS

($V_{INA} = V_{INB} = 5V$, $V_{\overline{ONA}} = V_{\overline{ONB}} = 0V$ (MAX1558), $V_{ONA} = V_{ONB} = 5V$ (MAX1558H), $R_{ISET} = 26k\Omega$ to GND, $T_A = -40^\circ C$ to $+85^\circ C$, unless otherwise noted.)

PARAMETER	SYMBOL	CONDITIONS	MIN	TYP	MAX	UNITS
Supply Voltage Range			2.7		5.5	V
Switch On-Resistance	R_{ON}	$V_{IN_} = 5V$, $T_A = +25^\circ C$			75	$m\Omega$
		$V_{IN_} = 4.4V$, $T_A = 0^\circ C$ to $+85^\circ C$			105	
Standby Supply Current		Both switches disabled			6	μA
Quiescent Supply Current		Both switches enabled			75	μA
OUT_ Off-Leakage Current		Switches disabled, $V_{OUTA} = V_{OUTB} = 0V$			10	μA
Undervoltage-Lockout Threshold	V_{UVLO}	Rising edge, 3% hysteresis	2.3		2.7	V
Continuous Load Current		$R_{ISET} = 26k\Omega$	1.2			A
Current-Limit Threshold		$V_{IN_} - V_{OUT_} = 0.5V$	$R_{ISET} = 26k\Omega$	1.20	1.60	A
			$R_{ISET} = 39k\Omega$	0.80	1.05	
			$R_{ISET} = 60k\Omega$	0.50	0.70	
Peak Short-Circuit Current Limit	I_{SHORT}	$V_{OUT_} = 0V$ ($I_{OUT_}$ pulsing)	$R_{ISET} = 26k\Omega$	1.45	2.60	$A_{(PEAK)}$
Fault-Blanking Timeout Period		From I_{LIMIT} condition to 50% of $V_{\overline{FLT_}}$	8		40	ms

Dual, 3mm x 3mm, 1.2A/Programmable-Current USB Switches with Autoreset

ELECTRICAL CHARACTERISTICS (continued)

($V_{INA} = V_{INB} = 5V$, $V_{\overline{ONA}} = V_{\overline{ONB}} = 0V$ (MAX1558), $V_{ONA} = V_{ONB} = 5V$ (MAX1558H), $R_{ISET} = 26k\Omega$ to GND, $T_A = -40^\circ C$ to $+85^\circ C$, unless otherwise noted.)

PARAMETER	SYMBOL	CONDITIONS	MIN	TYP	MAX	UNITS
Turn-On Delay	t_{ON}	$R_{OUT_} = 10\Omega$, $C_{OUT_} = 1\mu F$, does not include rise time (from ON asserted to $V_{OUT_} = 10\% V_{IN_}$)	0.5		4.0	ms
Turn-Off Delay from ON	t_{OFF}	$R_{OUT_} = 10\Omega$, $C_{OUT_} = 1\mu F$, does not include rise time (from ON deasserted to $V_{OUT_} = 90\% V_{IN_}$)			1000	μs
ONA/ONB Logic Input High Voltage	V_{IH}	$V_{IN_} = 2.7V$ to $4.0V$	1.6			V
		$V_{IN_} = 4.0V$ to $5.5V$	2.0			
ONA/ONB Logic Input Low Voltage	V_{IL}	$V_{IN_} = 2.7V$ to $4.0V$			0.6	V
		$V_{IN_} = 4.0V$ to $5.5V$			0.8	
Logic Input Current		$V_{ON_} = 0V$ or $V_{IN_}$	-1		+1	μA
$\overline{FLT_}$ Output Low Voltage		$I_{SINK} = 1mA$			0.4	V
$\overline{FLT_}$ Output High Leakage Current		$V_{IN_} = V_{\overline{FLT_}} = 5.5V$			1	μA
Autorestart Current		In latched-off state, $V_{OUT_} = 0V$	10		50	mA
Autorestart Threshold		In latched-off state, rising	0.4		0.6	V
Autorestart Delay		In latched-off state, $V_{OUT_} > 1V$	8		40	ms

Note 3: Specifications from $0^\circ C$ to $-40^\circ C$ are guaranteed by design but not 100% tested.

Note 4: The output voltage at which the device transitions from short-circuit current limit to continuous current limit. See the *Output-Current Fault Protection* section.

Typical Operating Characteristics

($V_{INA} = V_{INB} = 5V$, $V_{\overline{ONA}} = V_{\overline{ONB}} = 0V$ (MAX1558), $V_{ONA} = V_{ONB} = 5V$ (MAX1558H), $R_{ISET} = 26k\Omega$ to GND. Typical values are at $T_A = +25^\circ C$, unless otherwise noted.)

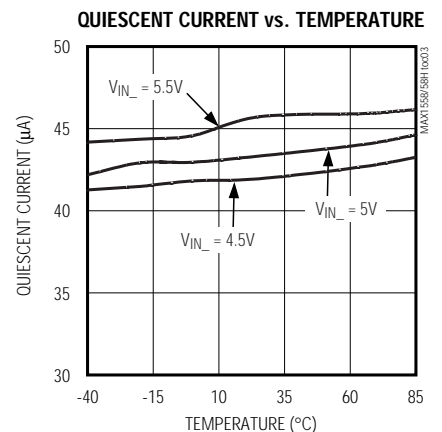
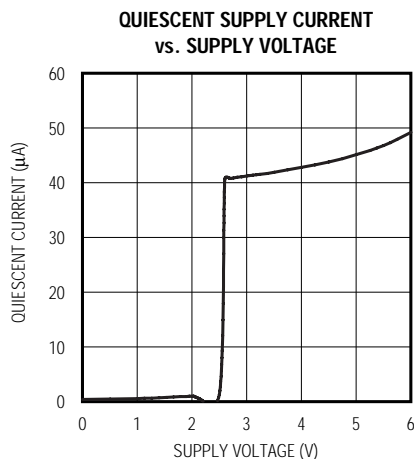
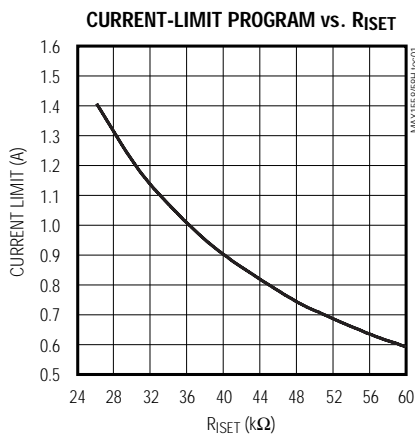

Dual, 3mm x 3mm, 1.2A/Programmable-Current USB Switches with Autoreset

Typical Operating Characteristics (continued)

($V_{INA} = V_{INB} = 5V$, $V_{ONA} = V_{ONB} = 0V$ (MAX1558), $V_{ONA} = V_{ONB} = 5V$ (MAX1558H), $R_{ISET} = 26k\Omega$ to GND. Typical values are at $T_A = +25^\circ C$, unless otherwise noted.)

MAX1558/MAX1558H

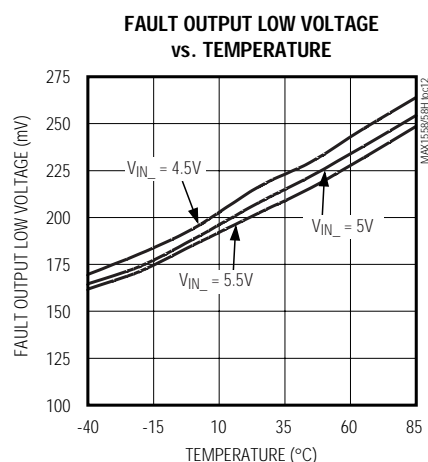
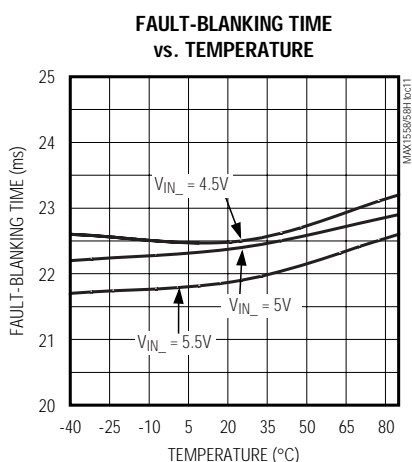
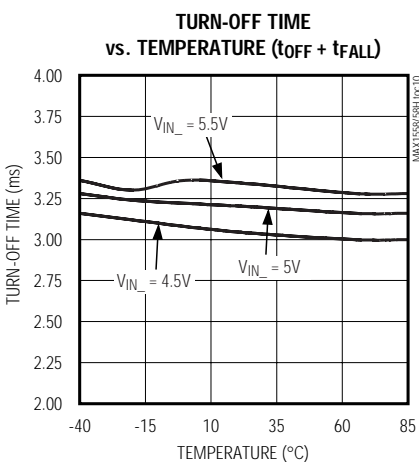
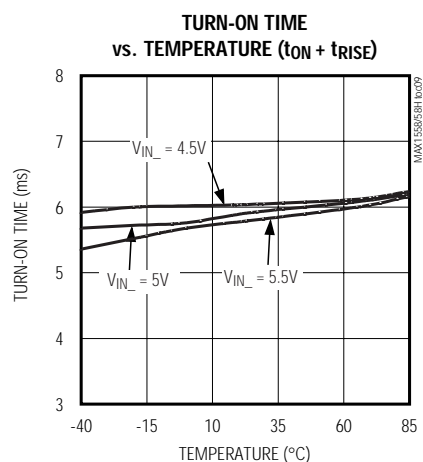
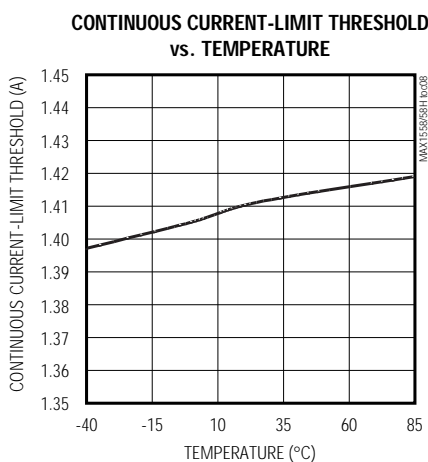
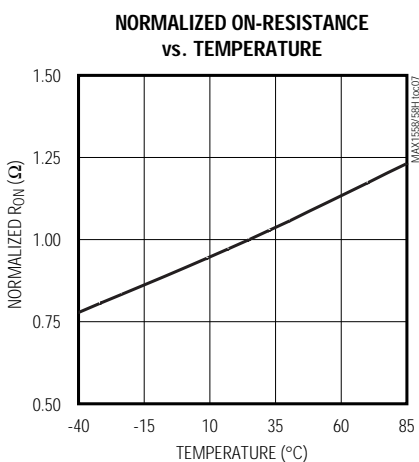
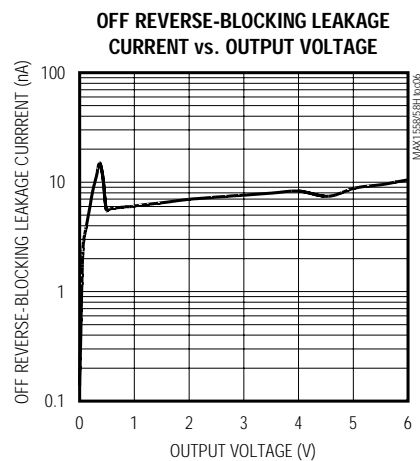
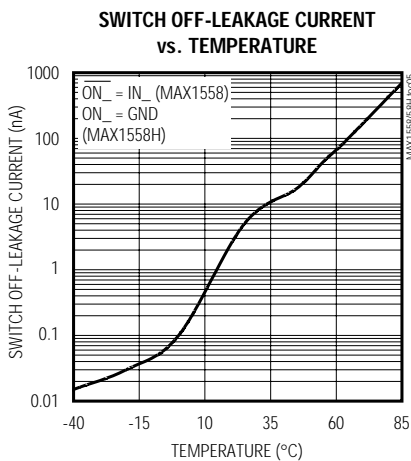
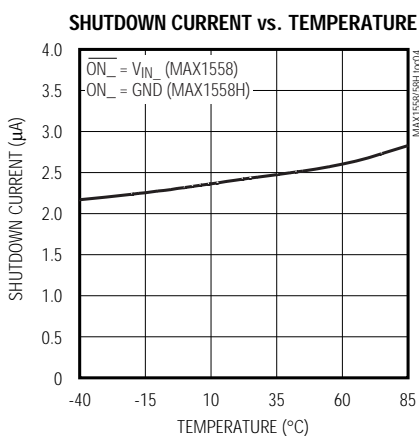

Dual, 3mm x 3mm, 1.2A/Programmable-Current USB Switches with Autoreset

Typical Operating Characteristics (continued)

($V_{IN_A} = V_{IN_B} = 5V$, $V_{ON_A} = V_{ON_B} = 0V$ (MAX1558), $V_{ON_A} = V_{ON_B} = 5V$ (MAX1558H), $R_{ISET} = 26k\Omega$ to GND. Typical values are at $T_A = +25^\circ C$, unless otherwise noted.)

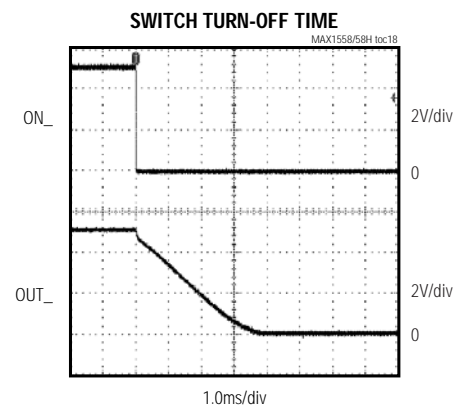
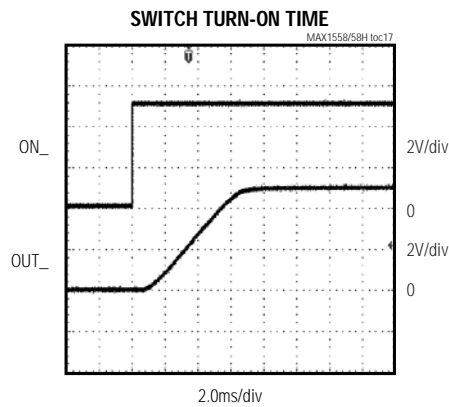
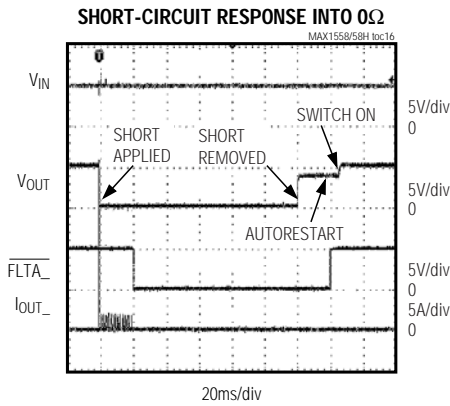
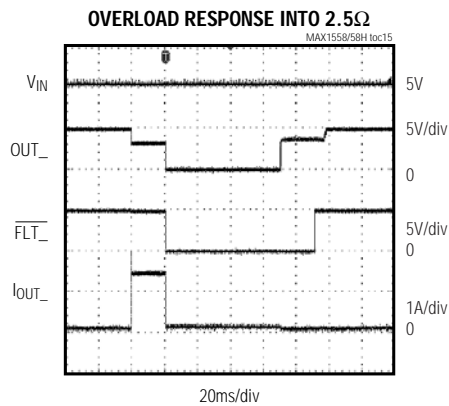
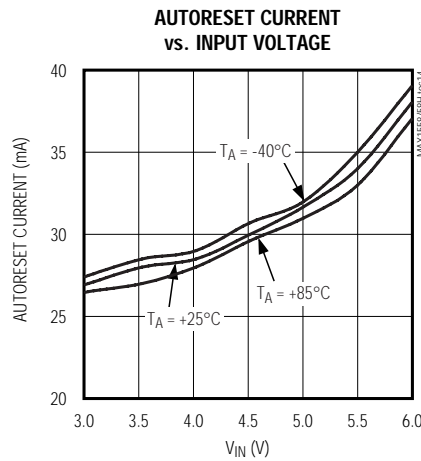
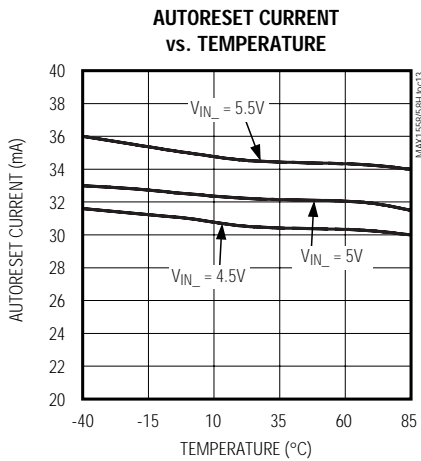

Dual, 3mm x 3mm, 1.2A/Programmable-Current USB Switches with Autoreset

MAX1558/MAX1558H

Pin Description

PIN	NAME	FUNCTION
1	INA	Power Input for OUTA. Connect INA and INB together and bypass with a 0.1 μ F capacitor to ground. Load conditions may require additional bulk capacitance to prevent the input from being pulled down.
2	$\overline{\text{ONA}}$ *(ONA)	Control Input for Switch A. Can be driven higher than IN ₋ without damage. A logic low turns switch A on for the MAX1558. A logic high turns switch A on for the MAX1558H.
3	ISET	Current-Limit Adjust for Both Channels. Connect a resistor between 26k Ω to 60k Ω from ISET to ground to program the current limit. See <i>Setting the Current Limit</i> in the <i>Applications Information</i> section.
4	$\overline{\text{ONB}}$ *(ONB)	Control Input for Switch B. Can be driven higher than IN ₋ without damage. A logic low turns switch B on for the MAX1558. A logic high turns switch B on for the MAX1558H.
5	INB	Power Input for OUTB. Connect INB and INA together and bypass with a 0.1 μ F capacitor to ground. Load conditions may require additional bulk capacitance to prevent the input from being pulled down.
6	OUTB	Power Output for Switch B. Connect a 1 μ F capacitor from OUTB to ground. The load condition may require additional bulk capacitance.
7	$\overline{\text{FLT B}}$	Fault Indicator Output for Switch B. This open-drain output goes low when switch B is in thermal shutdown or UVLO or in a sustained (>20ms) current-limit or short-circuit condition.
8	GND	Ground
9	$\overline{\text{FLT A}}$	Fault Indicator Output for Switch A. This open-drain output goes low when switch A is in thermal shutdown or UVLO or in a sustained (>20ms) current-limit or short-circuit condition.
10	OUTA	Power Output for Switch A. Connect a 1 μ F capacitor from OUTA to ground. The load condition may require additional bulk capacitance.
—	PAD	Exposed Pad, Internally Connected to GND. Connect exposed pad to a large copper trace for maximum power dissipation.

*() are for the MAX1558H only.

Detailed Description

The MAX1558/MAX1558H are dual current-limited switches designed for USB applications. They have two independent switches, each with its own enable control input and autoreset function. Each switch has an error-flag output to notify the USB controller when current-limit, short-circuit, undervoltage-lockout, or thermal-shutdown conditions occur (Figure 2). The MAX1558/MAX1558H operate from a 2.7V to 5.5V supply. Each output can supply up to 1.2A. Current limit for both channels is set with one external resistor.

The MAX1558/MAX1558H have independent thermal shutdown for each switch in the event of a prolonged overload. An autoreset function monitors the output and automatically turns the switch on when the overload is removed. Separate current limiting and thermal-shutdown circuits permit each switch to operate independently, improving system robustness.

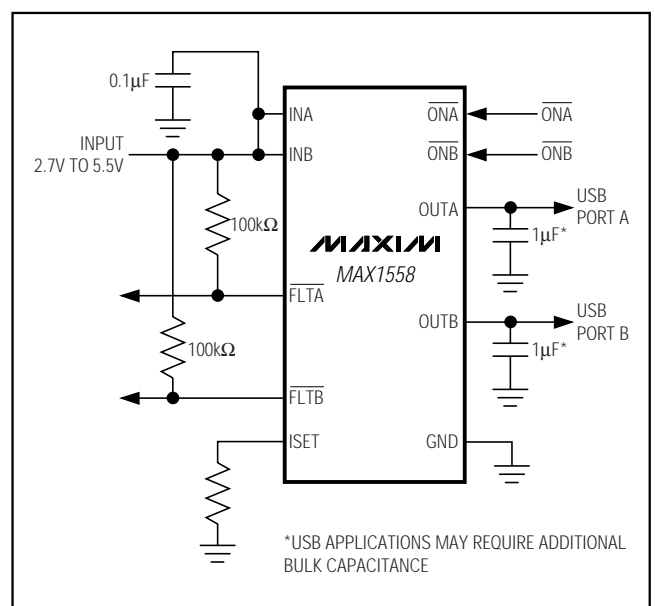

Figure 1. Typical Application Circuit

Dual, 3mm x 3mm, 1.2A/Programmable-Current USB Switches with Autoreset

Undervoltage Lockout and Input Voltage Requirements

The MAX1558/MAX1558H include a UVLO circuit to prevent erroneous switch operation when the input voltage is low during startup and brownout conditions. Operation is inhibited when $V_{IN_}$ is less than 2.5V.

Output-Current Fault Protection

The current limit for both switch outputs is programmed by a resistor between 26k Ω and 60k Ω connected from ISET to ground. See the Current-Limit Program Level vs. R_{ISET} curve in the *Typical Operating Characteristics* and *Setting the Current Limit* in the *Applications Information* section. The MAX1558 reduces the gate drive to the MOSFET switch when the programmed current-limit value is reached. If the current-limit program value is reached, the part reduces gate drive to regulate at the current limit. If the current limit persists for 20ms (typ), the output turns off and the fault flag is set until the fault is removed, as detected by the autoreset circuit.

When the the output drops below 1V (typ), the current limit is set 30% above the programmed level and pulsed. This lowers the RMS current for a short-circuit condition, which reduces system load current and power dissipation. If a short circuit persists for 20ms, the output turns off and the fault flag is set. The autoreset circuit automatically restarts the part if the fault is removed.

Fault Blanking

The MAX1558/MAX1558H switches can reach current limit in normal operation when powering up or driving heavy capacitive loads. To differentiate these conditions from short circuits or sustained overloads, the MAX1558/MAX1558H have independent fault-blanking circuits in each switch. When a load transient causes the device to enter the current limit, an internal counter monitors the duration of the fault. For load faults exceeding the 20ms fault-blanking time, the offending switch turns off, the corresponding $\overline{FLT_}$ signal asserts low, and that channel enters autoreset mode (see the *Autoreset Mode* section). Only current-limit and short-circuit faults are blanked. Thermal-overload faults and input-voltage drops below the UVLO threshold immediately cause the switch to turn off and $\overline{FLT_}$ to assert low.

Fault blanking allows the MAX1558 to handle USB loads that may not be fully compliant with USB specifications. USB loads with additional bypass capacitance and/or large startup currents can be successfully powered even while protecting the upstream power source. No fault is indicated if the switch is able to bring up the load within the 20ms blanking period.

Autoreset Mode

If an output fault is detected for more than the 20ms blanking time, the output latches off and the $\overline{FLT_}$ output goes low. The MAX1558/MAX1558H then source 30mA to the faulted output and monitor the output voltage to determine when the overload is removed. If the voltage on the output rises above 0.5V for more than 20ms, the fault resets and the output turns on. The MAX1558 can also be reset from fault manually by toggling $\overline{ON_}$ ($\overline{ON_}$ for the MAX1558H) for that channel.

Reverse Current Blocking

The USB specification does not allow an output device to source current back into the USB port. However, the MAX1558/MAX1558H are designed to safely power noncompliant devices. When disabled, each output is switched to a high-impedance state, blocking reverse-current flow from the output back to the input. However, during normal operation with the device enabled, the MAX1558/MAX1558H are bidirectional switches.

Thermal Shutdown

The MAX1558/MAX1558H feature independent thermal shutdown for each switch channel, allowing one switch to deliver power even if the other switch has a fault condition. When the junction temperature exceeds +160°C, the switch turns off and the $\overline{FLT_}$ output goes low immediately; fault blanking does not occur during thermal limit. When the junction cools by 10°C, the switch turns on again. If the fault-overload condition continues, the switch cycles on and off, resulting in a pulsed output, saving battery power.

Fault Indicators

The MAX1558/MAX1558H provide an open-drain fault output ($\overline{FLT_}$) for each switch. For most applications, connect $\overline{FLT_}$ to $\overline{IN_}$ through a 100k Ω pullup resistor. $\overline{FLT_}$ goes low when any of the following conditions occur:

- The input voltage is below the UVLO threshold.
- The switch junction temperature exceeds the +160°C thermal-shutdown temperature limit.
- The switch is in current-limit or short-circuit limit mode after the 20ms fault-blanking period is exceeded.
- The switch is in autoreset mode.

After the fault condition is removed, the $\overline{FLT_}$ output deasserts after a 20ms delay. Ensure that the MAX1558/MAX1558H have adequate input bypass capacitance to prevent glitches from triggering $\overline{FLT_}$ outputs. Glitches that cause the input supply to drop below 2.5V may cause the undervoltage lockout to trigger, turning the outputs off and asserting the $\overline{FLT_}$ signals.

Dual, 3mm x 3mm, 1.2A/Programmable-Current USB Switches with Autoreset

Applications Information

Setting the Current Limit

A resistor from ISET to ground programs the current-limit value for both outputs. Use a resistor between 26k Ω and 86k Ω to set the current limit according to the formula:

$$I_{LIM(TYPICAL)} = 36400 / R_{ISET} \text{ (Amps)}$$

Do not use R_{ISET} values below 26k Ω because the maximum current rating of the device may be exceeded. R_{ISET} values larger than 60k Ω are not recommended and do not provide a lower limit current than 500mA.

If the output drops below 1V (typ), the MAX1558 shifts to a short-circuit current-limit threshold that is 30% above the programmed level given by the $I_{LIM(TYPICAL)}$ formula. If the short-circuit threshold is exceeded, the switch shuts off immediately (no 20ms delay) and ramps the current back up in approximately 3ms. If the short persists and the current ramps all the way up to the short-circuit limit again, the switch again turns off. If the short still persists, the output pulses this way for 20ms, at which time the switch turns off and autoreset mode begins.

Input Capacitor

INA and INB provide the power for all control and charge-pump circuitry and must be connected together externally. Connect a capacitor from IN_ to ground to limit the input-voltage drop during momentary output short-circuit conditions. A 0.1 μ F ceramic capacitor is required for local decoupling; higher capacitor values further reduce the voltage drop at the input. When driving inductive loads, a larger capacitance prevents voltage spikes from exceeding the MAX1558/MAX1558Hs' absolute maximum ratings.

Output Capacitor

Place a 1 μ F or greater capacitor at each output for noise immunity. When starting up into very large capacitive loads, the switch may pulse the output current at the short-circuit current-limit program level until the output voltage rises above 1V. Then, the capacitor continues to charge at the full, continuous current-limit program level. There is no limit to the output capacitor size, but to prevent a startup fault assertion, the capacitor must charge up within the fault-blanking delay period. Typically, starting up into a 500 μ F or smaller capacitor does not trigger a fault output. In addition to bulk capacitance, small-value (0.1 μ F or greater) ceramic capacitors improve the output's resilience to electrostatic discharge (ESD).

Driving Inductive Loads

A wide variety of devices (mice, keyboards, cameras, and printers) can load the USB port. These devices commonly connect to the port with cables, which can add an inductive component to the load. This inductance causes the output voltage at the USB port to ring during a load step. The MAX1558/MAX1558H are capable of driving inductive loads, but avoid exceeding the devices' absolute maximum ratings. Usually the load inductance is relatively small, and the MAX1558/MAX1558Hs' input includes a substantial bulk capacitance from an upstream regulator as well as local bypass capacitors, limiting overshoot. If severe ringing occurs due to large load inductance, clamp the MAX1558/MAX1558Hs' output below +6V and above -0.3V.

Turn-On and Turn-Off Behavior

In the absence of faults, the MAX1558/MAX1558Hs' internal switches turn on and off slowly under the control of the ON_ inputs. Transition times for both edges are approximately 4ms. The slow charge-pump switch drive minimizes load transients on the upstream power source. Under thermal fault and UVLO, the power device turns off rapidly (100ns) to protect the power device.

Layout and Thermal Dissipation

To optimize the switch response time to output short-circuit conditions, keep all traces as short as possible to reduce the effect of undesirable parasitic inductance. Place input and output capacitors no more than 5mm from device leads. All IN_ and OUT_ pins must be connected with short traces to the power bus. Wide power-bus planes provide superior heat dissipation through the switch IN_ and OUT_ pins. While the switches are on, power dissipation is small and the package temperature change is minimal. Calculate the power dissipation for this condition as follows:

$$P = (I_{OUT_})^2 R_{ON}$$

For the maximum operating current ($I_{OUT_} = 1.2A$) and the maximum on-resistance of the switch (125m Ω), the power dissipation is:

$$P = (1.2A)^2 \times 0.125\Omega = 180mW \text{ per switch}$$

The worst-case power dissipation occurs when the switch is in current limit and the output is greater than 1V. The instantaneous power dissipated in each switch is the voltage drop across the switch multiplied by the current limit. The fault-blanking circuit turns the output off if the fault persists for 20ms, while the autoreset circuit can turn it back on after 20ms in the off state. Thus, the average worst-case power is approximately 50% of the instantaneous value.

$$P = 0.5 \times (I_{LIM}) \times (V_{IN_} - V_{OUT_})$$

Dual, 3mm x 3mm, 1.2A/Programmable-Current USB Switches with Autoreset

For a 5V input and 1V output, the maximum possible power dissipation per switch is:

$$P = 0.5 \times (1.5A) \times (5V - 1V) = 3W$$

Since the package power dissipation is limited to 1952mW, the MAX1558/MAX1558H die temperature exceeds the thermal-shutdown threshold and the switch turns off. After the die temperature cools by 10°C, the switch turns on again. If the fault-overload condition continues, the switch cycles on and off with a duty cycle and period that is a function of the ambient temperature and PC board layout.

A short across the output for more than 20ms places the part in autoreset mode. With $V_{IN} = 5V$ and an autoreset test current of 30mA, the power dissipation for a short-circuited output is given by:

$$P = (30mA) \times 5V = 0.15W$$

Chip Information

TRANSISTOR COUNT: 2932

PROCESS: BiCMOS

MAX1558/MAX1558H

Dual, 3mm x 3mm, 1.2A/Programmable-Current USB Switches with Autoreset

Package Information

(The package drawing(s) in this data sheet may not reflect the most current specifications. For the latest package outline information, go to www.maxim-ic.com/packages.)

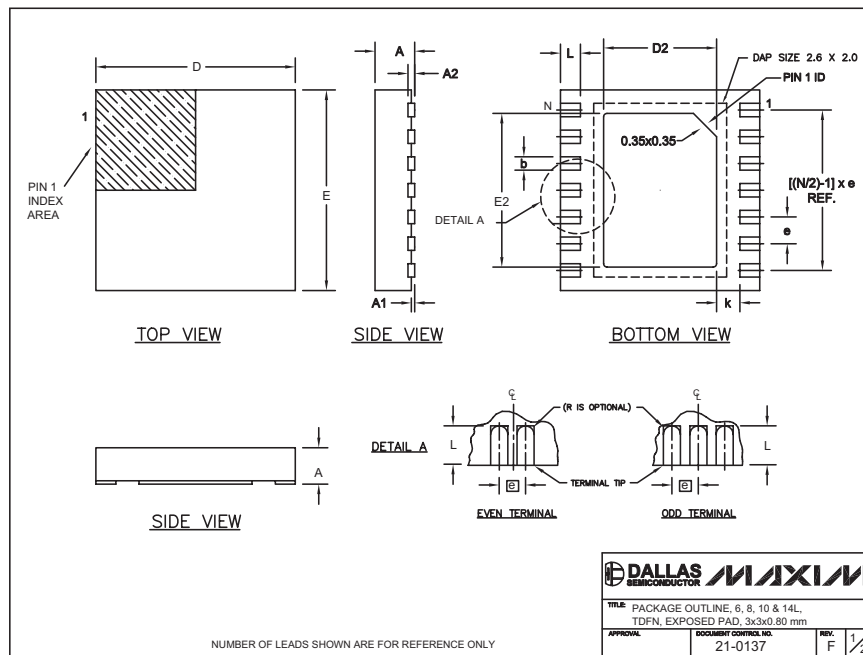

6, 8, & 10L: DFN THINLEADS

COMMON DIMENSIONS							
SYMBOL	MIN.	MAX.					
A	0.70	0.80					
D	2.90	3.10					
E	2.90	3.10					
A1	0.00	0.05					
L	0.20	0.40					
k	0.25 MIN.						
A2	0.20 REF.						

PACKAGE VARIATIONS							
PKG. CODE	N	D2	E2	e	JEDEC SPEC	b	[(N/2)-1] x e
T633-1	6	1.50±0.10	2.30±0.10	0.95 BSC	MO229 / WEEA	0.40±0.05	1.90 REF
T833-1	8	1.50±0.10	2.30±0.10	0.65 BSC	MO229 / WEEC	0.30±0.05	1.95 REF
T1033-1	10	1.50±0.10	2.30±0.10	0.50 BSC	MO229 / WEED-3	0.25±0.05	2.00 REF
T1433-1	14	1.70±0.10	2.30±0.10	0.40 BSC	----	0.20±0.03	2.40 REF
T1433-2	14	1.70±0.10	2.30±0.10	0.40 BSC	----	0.20±0.03	2.40 REF

NOTES:
 1. ALL DIMENSIONS ARE IN mm. ANGLES IN DEGREES.
 2. COPLANARITY SHALL NOT EXCEED 0.08 mm.
 3. WARPAGE SHALL NOT EXCEED 0.10 mm.
 4. PACKAGE LENGTH/PACKAGE WIDTH ARE CONSIDERED AS SPECIAL CHARACTERISTIC(S).
 5. DRAWING CONFORMS TO JEDEC MO229, EXCEPT DIMENSIONS "D2" AND "E2", AND T1433-1 & T1433-2.
 6. "N" IS THE TOTAL NUMBER OF LEADS.

DALLAS SEMICONDUCTOR **MAXIM**

TITLE: PACKAGE OUTLINE, 6, 8, 10 & 14L
TDFN, EXPOSED PAD, 3x3x0.80 mm

APPROVAL: _____ DOCUMENT CONTROL NO. 21-0137 REV. F 1/2

Maxim cannot assume responsibility for use of any circuitry other than circuitry entirely embodied in a Maxim product. No circuit patent licenses are implied. Maxim reserves the right to change the circuitry and specifications without notice at any time.

12 _____ Maxim Integrated Products, 120 San Gabriel Drive, Sunnyvale, CA 94086 408-737-7600