

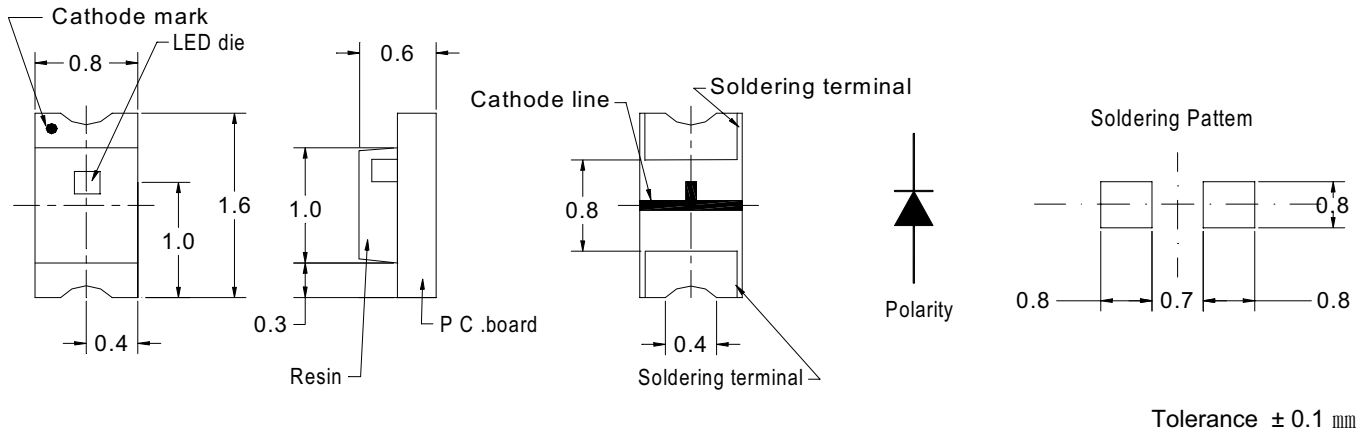

**BVS-166TB2**

**PACKAGE CONFIGURATION**



**DESCRIPTION**

Dice Material : AlGaInP/GaAs Yellow  
 Light Color : Yellow Color  
 Lens Color : Milky Diffused

**ABSOLUTE MAXIMUM RATINGS AT Ta = 25 °C**

PARAMETER	MAX.	UNIT
Power Dissipation	55	mW
Continuous Forward Current	20	mA
Peak Forward Current ( 1/10 Duty Cycle , 0.1ms Pulse Width )	100	mA
Reverse Voltage	5	V
Derating Linear From 25 °C	0.35	mA/°C
Operating Temperature Range	-30 to + 80	°C
Storage Temperature Range	-40 to + 85	°C
Reflow Soldering Condition 245 °C for 10 seconds		

**ELECTRICAL / OPTICAL CHARACTERISTICS AT Ta = 25 °C**

SYMBOL	PARAMETER	TEST COND.	MIN.	TYP.	MAX.	UNIT
V <sub>F</sub>	Forward Voltage	I <sub>F</sub> = 20 mA		2.1	2.6	V
I <sub>R</sub>	Reverse Current	V <sub>R</sub> = 5V			100	μA
λ <sub>p</sub>	Peak Emission Wavelength	I <sub>F</sub> = 20 mA		591		nm
λ <sub>d</sub>	Dominant Wavelength	I <sub>F</sub> = 20 mA		589		nm
2θ <sub>1/2</sub>	Viewing Angle	I <sub>F</sub> = 20 mA		130		Deg

**BIN GRADE LIMITS ( I F = 20 mA ) LUMINOUS INTENSITY / mcd**

Bin	x	y	z	A	B	C
Min.	47	60	78	100	130	168
Max.	60	78	100	130	168	218

Tolerance ± 15% mcd

\*Bright View reserves the rights to alter specifications and remove availability of products at any time without notice.

\*Dominant Wavelength, λ<sub>d</sub> is according to CIE Chromaticity Diagram base on color of lamps.

\*θ<sub>1/2</sub> is the off-axis angle where the luminous intensity is one half the on-axis intensity.

\*These products are sensitive to static electricity. Caution must be taken strictly to avoid static electricity.



**BVS-166TB2**

**TYPICAL ELECTRICAL / OPTICAL CHARACTERISTIC CURVES**

FIG. 1 Forward Current vs. Forward Voltage  
( $T_a = 25^\circ\text{C}$ )

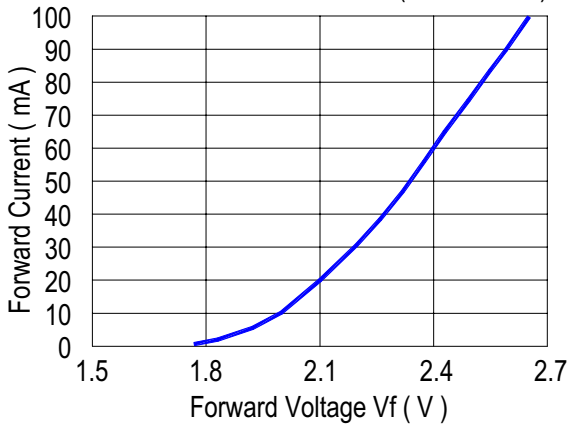

FIG. 2 Relative Intensity vs. Forward Current  
( $T_a = 25^\circ\text{C}$ )

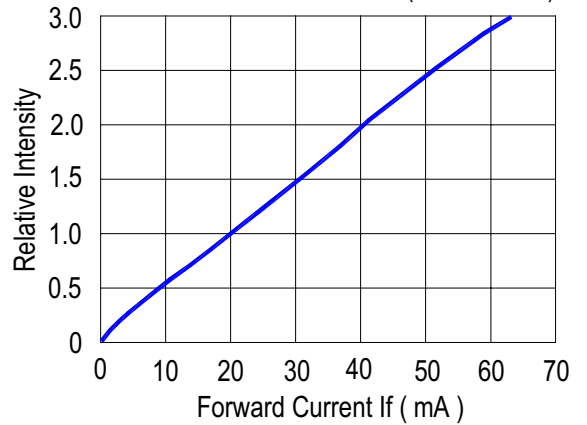

FIG. 3 Forward Voltage vs. Temperature

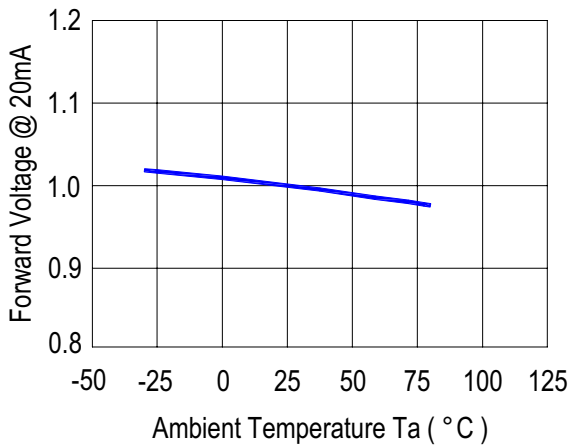

FIG. 4 Relative Intensity vs. Temperature

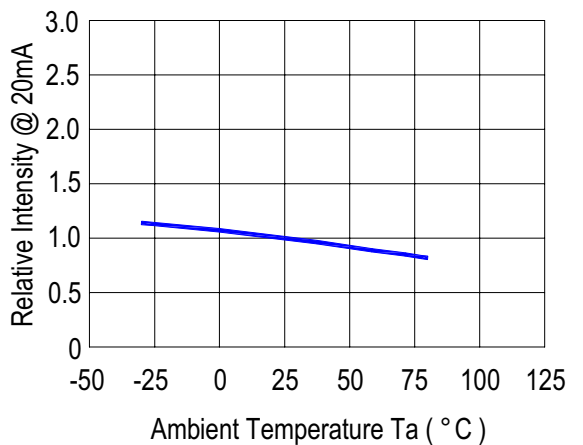

FIG. 5 Relative Intensity vs. Wavelength ( $\lambda_p$ )  
( $T_a = 25^\circ\text{C}$ )

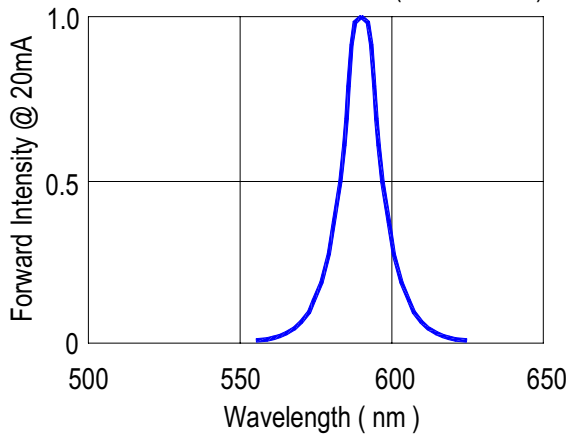
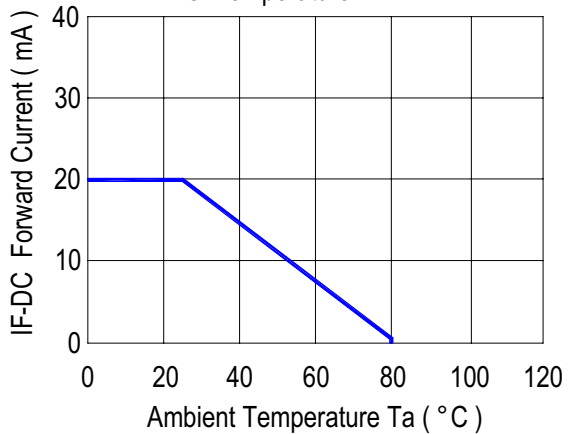

FIG. 6 Maximum Forward Current  
vs. Temperature





Apply to BVS-3XX 、 1XX series.

## Description:

(1) Manual soldering (We do not recommend this method strongly.)

- (1.1) To prevent cracking, please bake (65°C, 24hrs) before soldering.
- (1.2) Temperature at tip of iron: 250°C Max. (25W)
- (1.3) It's banned to load any stress on the resin during soldering.
- (1.4) Soldering time: 3 sec. Max. (one time only)

(2) Reflow Soldering

- (2.1) To prevent cracking, please bake (65°C, 24hrs) before soldering.
- (2.2) When soldering, do not put stress on the LEDs during heating.
- (2.3) Never take next process until the component is cooled down to room temperature after reflow.
- (2.4) After soldering, do not warp the circuit board.
- (2.5) The recommended reflow soldering profile (measuring on the surface of the LED resin) is following:

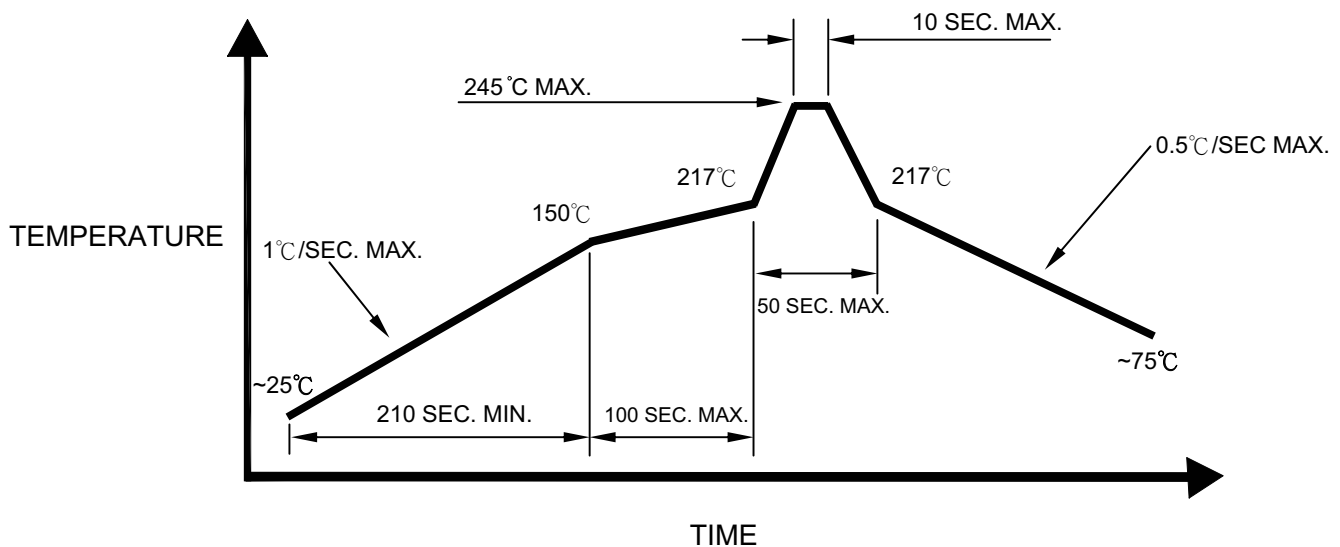

The reflow temperature 240°C~245°C is recommended and the soldering temperature should be not higher than 245°C (one time only)



**BVS-166/167 Series**

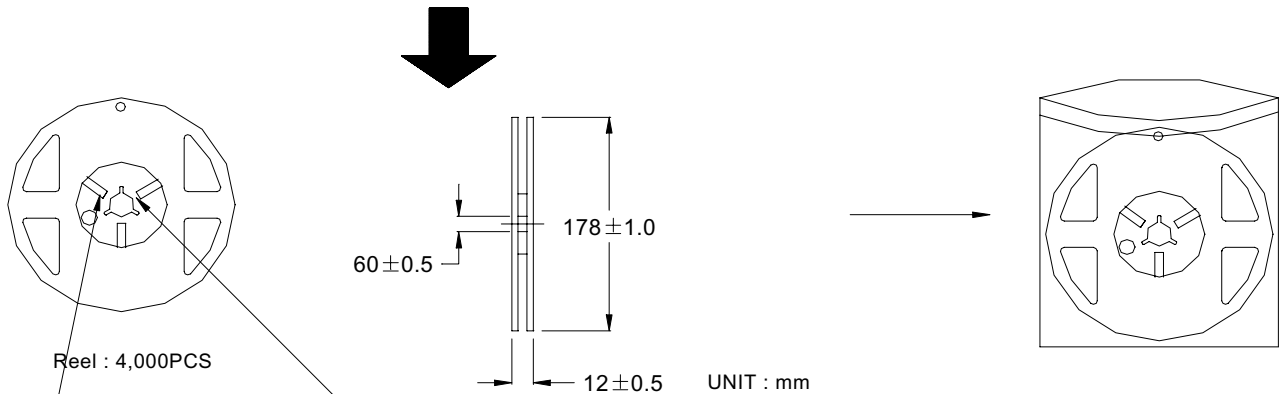
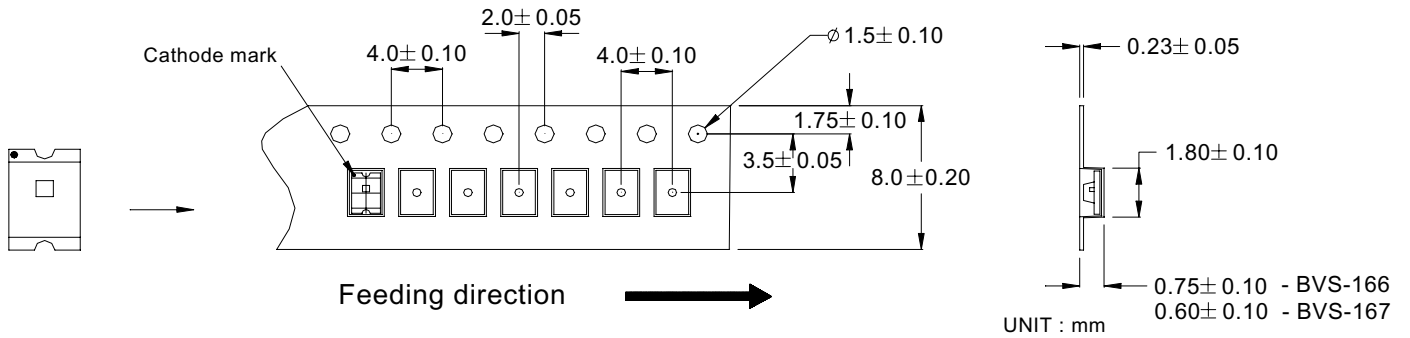

Label 1

**Bright View** Electronics Co.,Ltd.

PART NO.: BVS-16XXXX

LOT NO.: \_\_\_\_\_

GRADE: X - △ - ■

Q'ty \_\_\_\_\_ pcs QA

Label 2

**Bright View** Electronics Co.,Ltd.

PART NO.: \_\_\_\_\_

LOT NO.: \_\_\_\_\_

GRADE: \_\_\_\_\_

Q'ty \_\_\_\_\_ pcs QA

**CAUTION**  
ELECTROSTATIC SENSITIVE DEVICES  
DO NOT OPEN OR HANDLE EXCEPT  
AT A STATIC-FREE WORKSTATION

Normal  
X: Bin grade  
△: Wavelength  
■: Vf

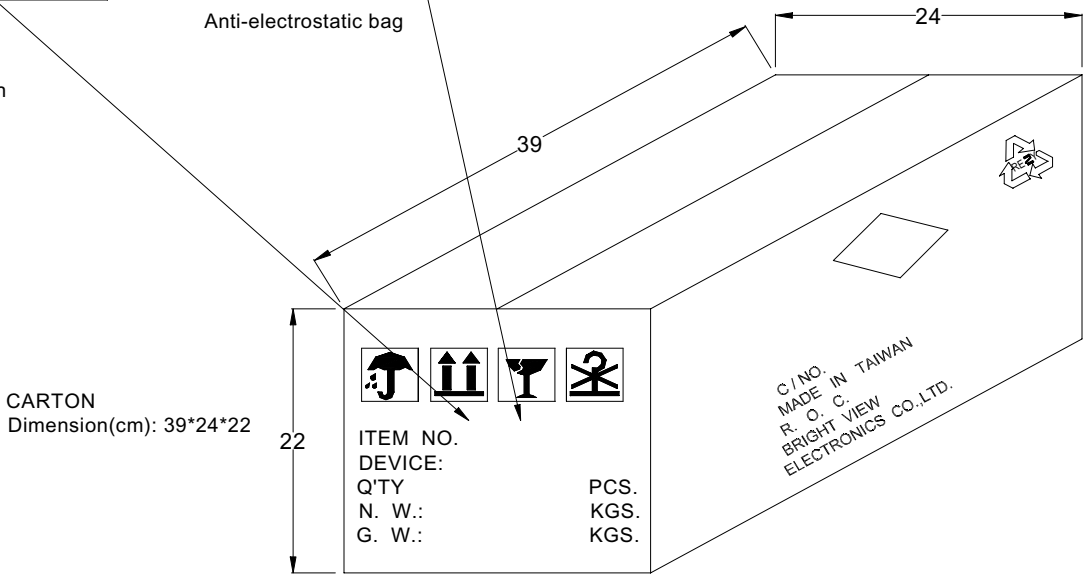

Carton : 30 Reels  
Total : 120,000PCS