

IGBT MODULE (Single-in-Line)

■ Features

- Square RBSOA
- Low Saturation Voltage
- Improved FWD Characteristic
- Minimized Internal Stray Inductance

■ Applications

- High Power Switching
- A.C. Motor Controls
- D.C. Motor Controls

■ Outline Drawing

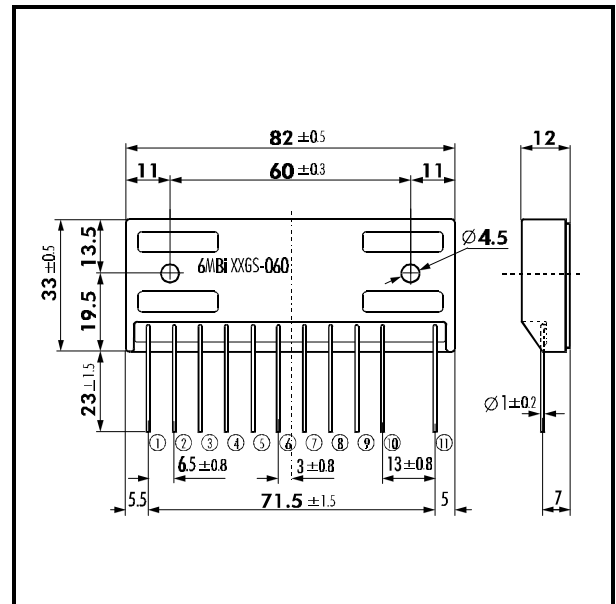

■ Maximum Ratings and Characteristics

• Absolute Maximum Ratings ($T_c=25^\circ\text{C}$)

Items	Symbols	Ratings	Units
Collector-Emitter Voltage	V_{CES}	600	V
Gate -Emitter Voltage	V_{GES}	± 20	V
Collector Current	Continuous	I_C	20
	1ms	$I_{C \text{ PULSE}}$	40
	Continuous	$-I_C$	20
	1ms	$-I_{C \text{ PULSE}}$	40
Max. Power Dissipation	P_C	70	W
Operating Temperature	T_j	+150	$^\circ\text{C}$
Storage Temperature	T_{stg}	-40 ~ +125	$^\circ\text{C}$
Isolation Voltage	A.C. 1min. V_{is}	2000	V
Screw Torque	Mounting *1	1.7	Nm

Note: *1:Recommendable Value; 1.3 ~ 1.7 Nm (M4)

■ Equivalent Circuit

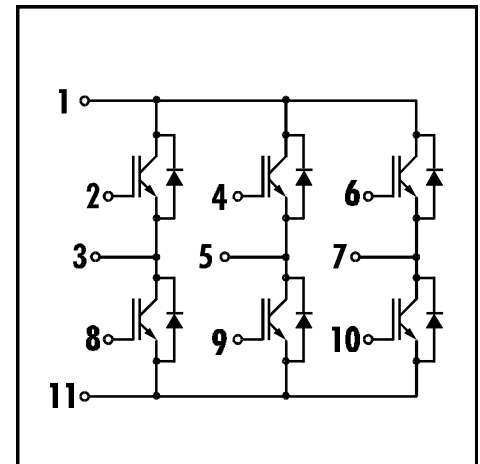

• Electrical Characteristics (at $T_j=25^\circ\text{C}$)

Items	Symbols	Test Conditions	Min.	Typ.	Max.	Units
Zero Gate Voltage Collector Current	I_{CES}	$V_{GE}=0V$ $V_{CE}=600V$			1.0	mA
Gate-Emitter Leakage Current	I_{GES}	$V_{CE}=0V$ $V_{GE}=\pm 20V$			100	nA
Gate-Emitter Threshold Voltage	$V_{GE(th)}$	$V_{GE}=20V$ $I_C=10mA$	5.5		8.5	V
Collector-Emitter Saturation Voltage	$V_{CE(sat)}$	$V_{GE}=15V$ $I_C=10A$			2.8	V
Input capacitance	C_{ies}	$V_{GE}=0V$		1300		pF
Output capacitance	C_{oes}	$V_{CE}=10V$		300		
Reverse Transfer capacitance	C_{res}	$f=1MHz$		72		
Turn-on Time	t_{ON}	$V_{CC}=300V$			1.2	μs
	t_r	$I_C=20A$			1.0	
Turn-off Time	t_{OFF}	$V_{GE}=\pm 15V$			1.0	
	t_f	$R_G=120\Omega$			0.35	
Diode Forward On-Voltage	V_F	$I_F=20A$ $V_{GE}=0V$			3.0	V
Reverse Recovery Time	t_{rr}	$I_F=20A$			300	ns

• Thermal Characteristics

Items	Symbols	Test Conditions	Min.	Typ.	Max.	Units
Thermal Resistance	$R_{th(j-c)}$	IGBT			1.79	$^\circ\text{C/W}$
	$R_{th(j-e)}$	Diode			2.50	
	$R_{th(c-f)}$	With Thermal Compound		0.06		

Collector-Emitter voltage vs. Collector current
T_j=25°C

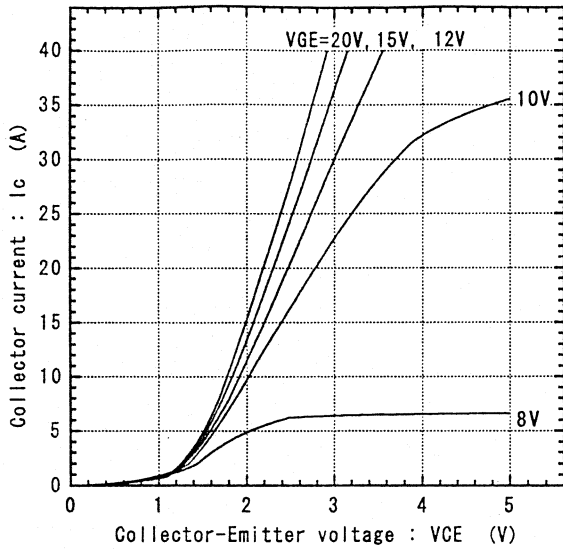

Collector-Emitter voltage vs. Collector current
T_j=125°C

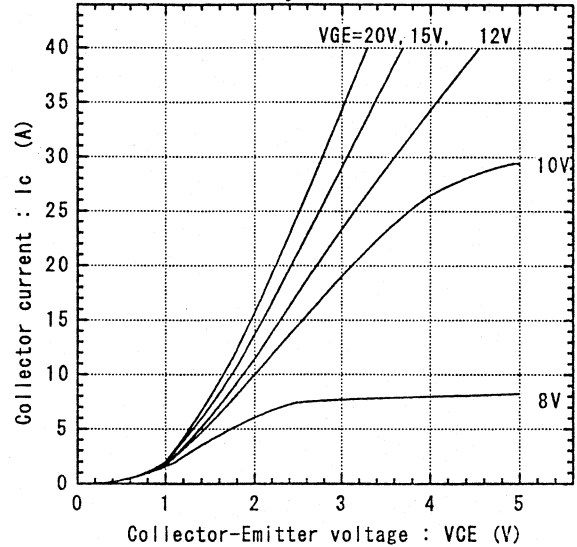

Collector-Emitter vs. Gate-Emmitter voltage
T_j=25°C

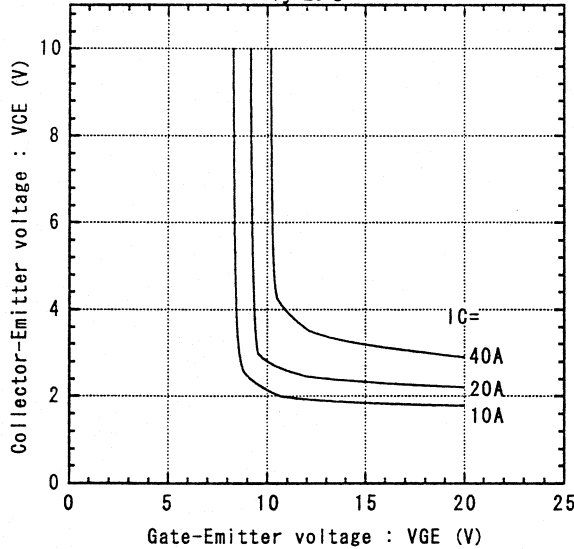

Collector-Emitter vs. Gate-Emmitter voltage
T_j=125°C

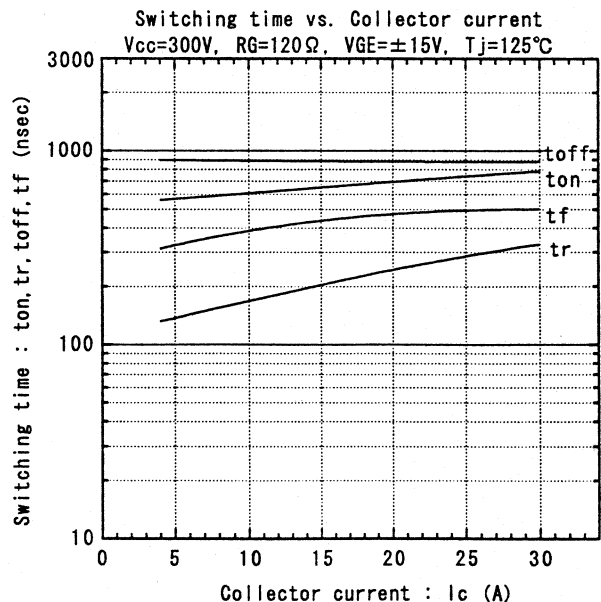
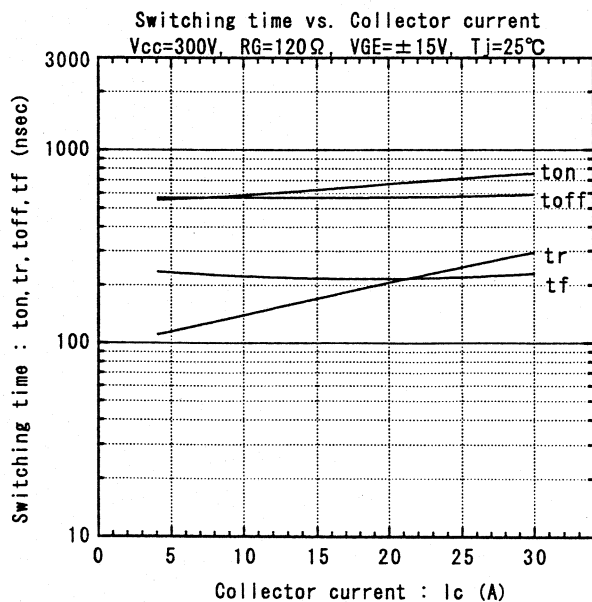
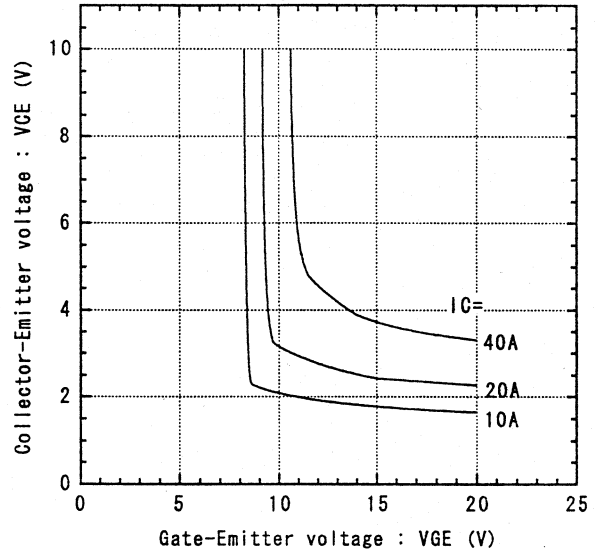

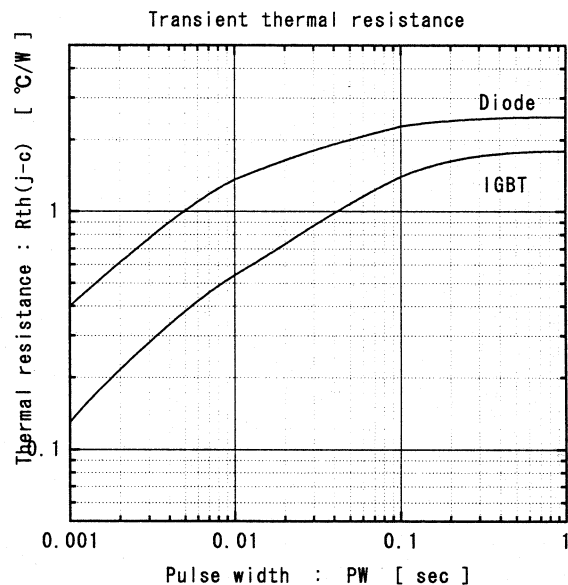
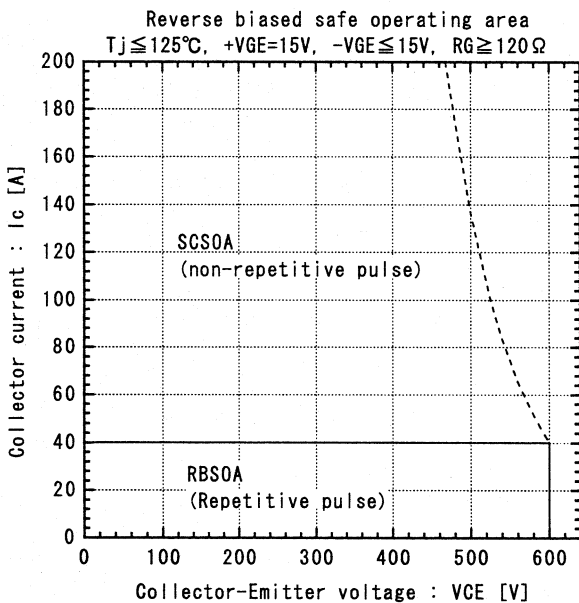
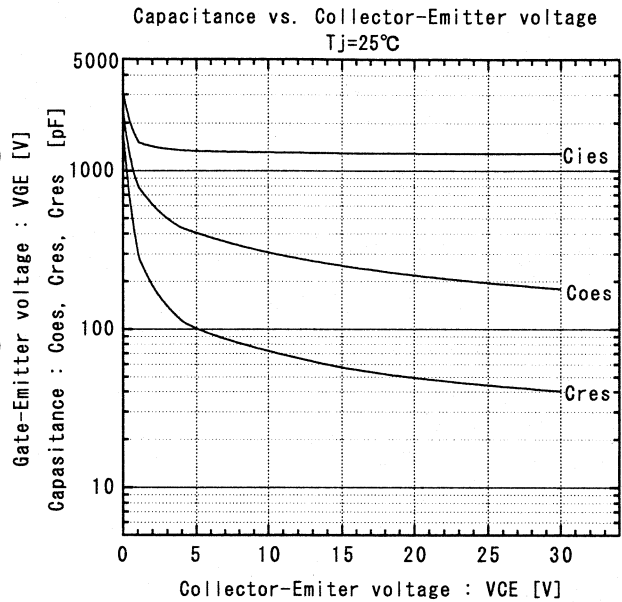
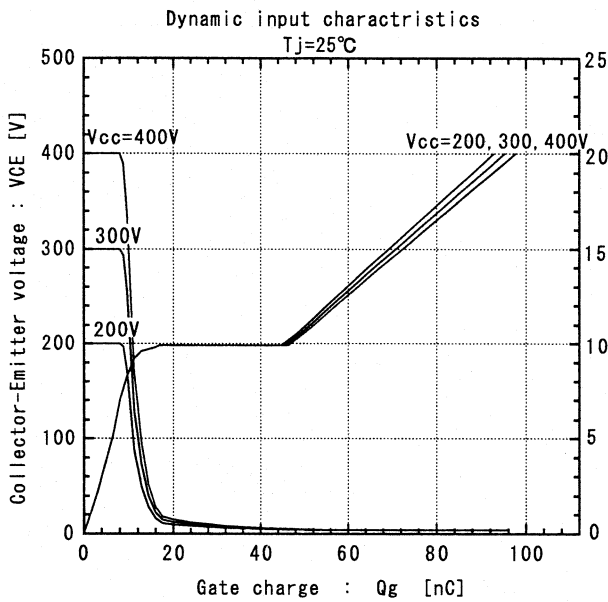
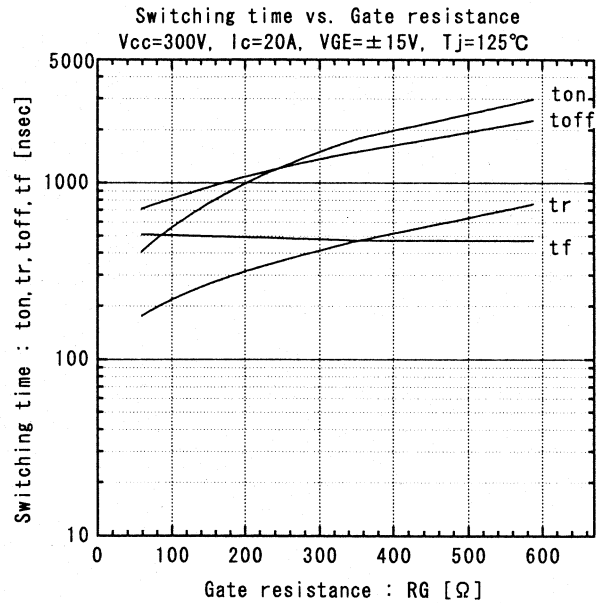
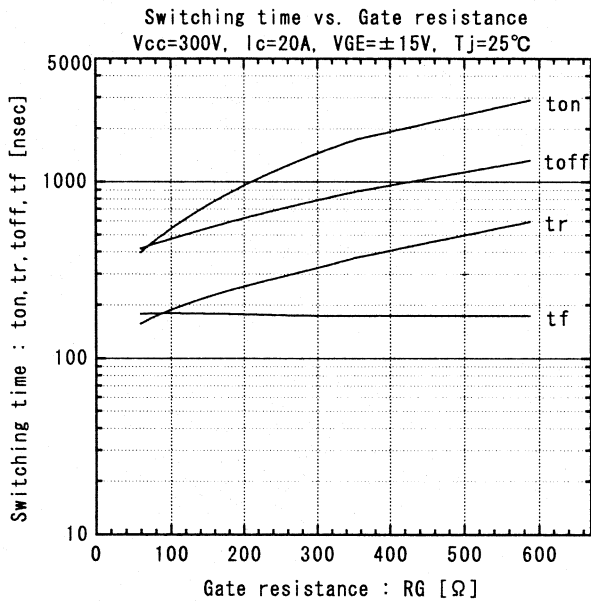

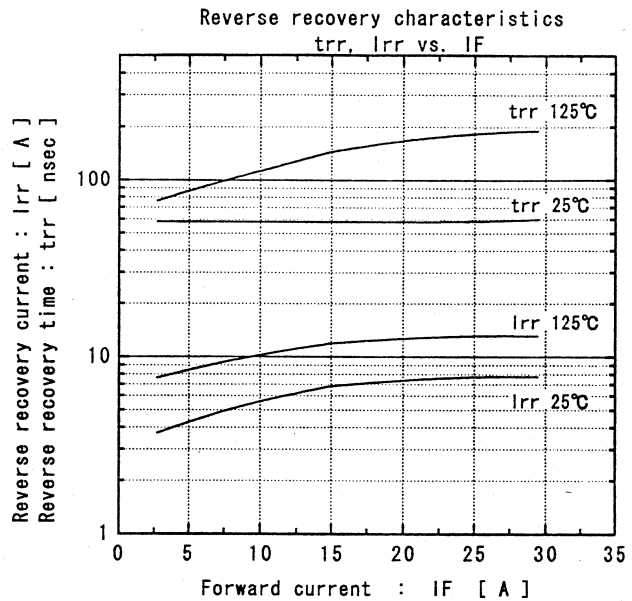
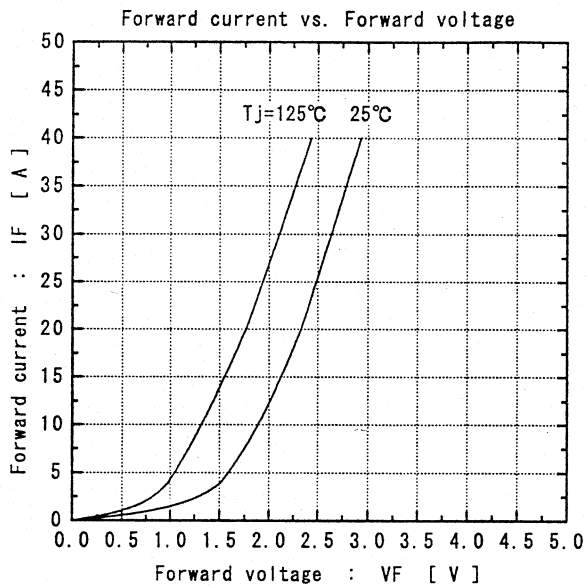
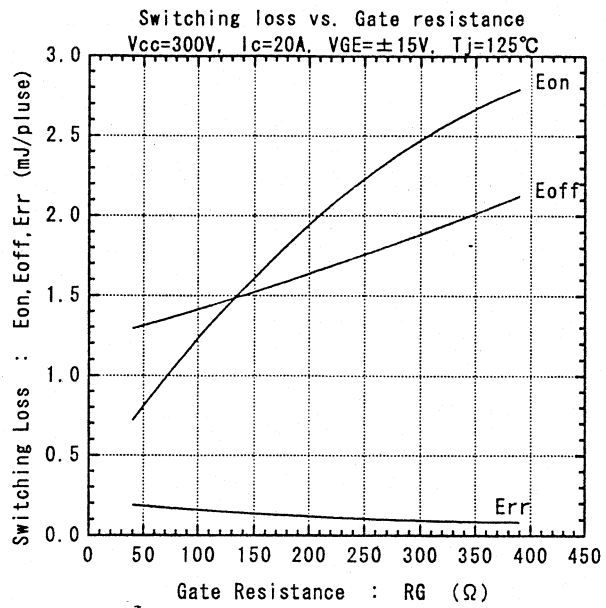
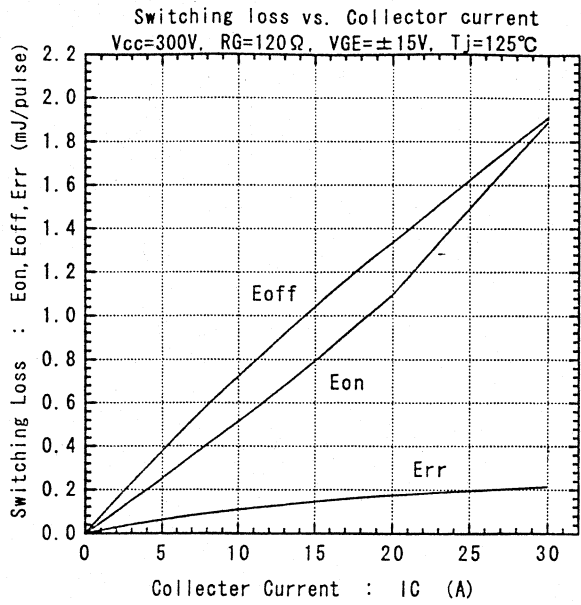

Fuji Electric GmbH

Lyoner Straße 26

D-60528 Frankfurt/M

Tel.: 069 - 66 90 29 - 0

Fax.: 069 - 66 90 29 - 56

Fuji Electric (UK) Ltd.

Commonwealth House
2 Chalkhill Road Hammersmith

London W6 8DW, UK

Tel.: 0181 - 233 11 30

Fax.: 0181 - 233 11 60