



# AN1487 APPLICATION NOTE

## 35W FLYBACK CONVERTERS FOR SET-TOP BOX APPLICATIONS USING THE VIPer100A

G. Bacchin - C. Spini

### ABSTRACT

This document describes a reference design of a 35W Switch Mode Power Supply dedicated to Set-Top Box application. The board accepts full range input voltage (90 to 265Vrms) and delivers 5 outputs. It is based on the VIPer100A integrating the controller and a Power MOSFET, working at fixed frequency, PWM mode.

### 1.0 INTRODUCTION

Set-Top Boxes growth is very fast in all the Countries either for satellite or terrestrial decoding and so the market asks for solutions with good performances and high cost effectiveness in small volumes. The integrated monolithic solution like the VIPer makes it a very suitable device. It is able to satisfy all the requirements of a compact and flexible design with only few external components, integrating all the necessary functions to have a robust design. A specific application circuit is here proposed.

### 1.1 Main Characteristics

The main characteristics of the SMPS are listed here below:

Table 1: Input Parameters

Symbol	Parameter	Value	Unit
Vin	Input Voltage	90 - 264	Vrms
f	Frequency	45-66	Hz

Table 2: Output Parameters

Vout (V)	Iout (A)	Pout (W)	STABILITY	NOTES
3.3	4	13.2	+/- 2%	
5	1.5	7.5	+/- 2%	(A)
12	0.4	4.8	+/- 5%	(B)
35	0.015	0.525	+/- 8%	(C)
22/17	0.35	7.7	+/- 2%	(D-E)
<b>P<sub>OUT</sub>=</b>		<b>33.725 (W)</b>		

#### NOTES:

(A)Dedicated to 5V digital circuitry and to 3.3V local post regulators

(B)Dedicated to SCART and general purpose circuits

(C)Dedicated to tuner

(D)Dedicated to LNB regulator

(E)The output voltage value is selectable via the signal "CONTROL" - TTL comp. Or Open Coll.

1 = 22V - 0 = 17V

## AN1487 - APPLICATION NOTE

---

### 1.1.1 Stand-by

No stand-by mode is foreseen by equipment

### 1.1.2 Overcurrent Protection

On all outputs, with auto-restart at short protection

### 1.1.3 PCB Type & Size

Cu Single Side 70  $\mu$ m, FR-4, 131 x 100 mm

### 1.1.4 Safety

In accordance with EN60950, creepage and clearance minimum distance 6.4mm

### 1.1.5 EMI

In accordance with EN50022 Class B

## 2.0 PRINCIPLE OF OPERATION

The core of the design is a VIPer100A, integrating the controller and a MOSFET in a standard TO-220FP insulated. The switching frequency (~65 kHz) has been chosen to get a compromise between the transformer size and the harmonics of the switching frequency, in order to optimise the input filter size and its cost. The transformer reflected voltage is ~50V, providing enough room for the leakage inductance voltage spike with still margin for reliability. The diodes D1 and D15 clamp the peak of the leakage inductance voltage spike at a safe level for reliable operation of the device.

The VIPer100A is activated by an internal current source that draws current from the DC bus and charges the capacitor C12. Thanks to this circuit, the start-up time is short and independent from the input mains voltage. During the normal operation, the controller is powered by the transformer via the diode D6. The network Q2, C33, R27 acts as a lead edge blanking, deleting the spikes at Mosfet turn-off. This improves the auxiliary voltage stability and the circuit performance during short circuits. R2 and C2 determine the switching frequency and the maximum duty cycle while R1 and C3 are a protection against discharges. The capacitor C4 is part of the compensation loop, while the zener D11 is a cheap solution for clamping the E/A output voltage, so the maximum power delivered by the circuit. This zener plays an important role during the output short circuit protection of the circuit.

The output rectifiers have been chosen in accordance with the maximum reverse voltage and power dissipation. The rectifier for 3.3V is a Schottky barrier, type STPS10L60CF. This diode has low forward voltage drop, hence dissipating less power with respect to a standard type. Due to the high current delivered by the output, it needs to be mounted on a heat sink. The P/N is indicated on the BOM. A small LC filter has been added on the +3.3V in order to filter the high frequency ripple without increasing the output capacitors size. The other two output rectifiers are axial, fast recovery.

The output voltage regulation is performed by the secondary feedback on the 3.3V output. The feedback network is the classical one using a TL431 driving an optocoupler, in this case a TCDT1102G, insuring the required insulation between primary and secondary. The opto-transistor drives directly the COMP pin of the Viper. The 5V output stability is assured by the DC/DC converter based on the ST L4971 (IC6) while a standard linear regulator assures the 12V stability at low cost. A dedicated DC/DC converter based on the ST34063A provides the suitable voltage dedicated to the LNB of the satellite parabola. The input of this converter is connected to the +35V output dedicated to the tuner. The stability of the 35V is guarantee by the transformer coupling.

The input EMI filter is a classical Pi-filter, 1-cell for differential and common mode noise. A NTC limits the inrush current produced by the capacitor charging at plug-in and a standard 5\*20 fuse protects from catastrophic failures.

The transformer is slot type, manufactured by OREGA, in accordance with the EN60950.

The figures 2 and 3 show the drain voltage and current at the nominal input mains voltage during normal operation at full load. As visible the working frequency is almost 66kHz. At low mains the transformer works at the boundary of the CCM.

Figure 1: Electrical schematic

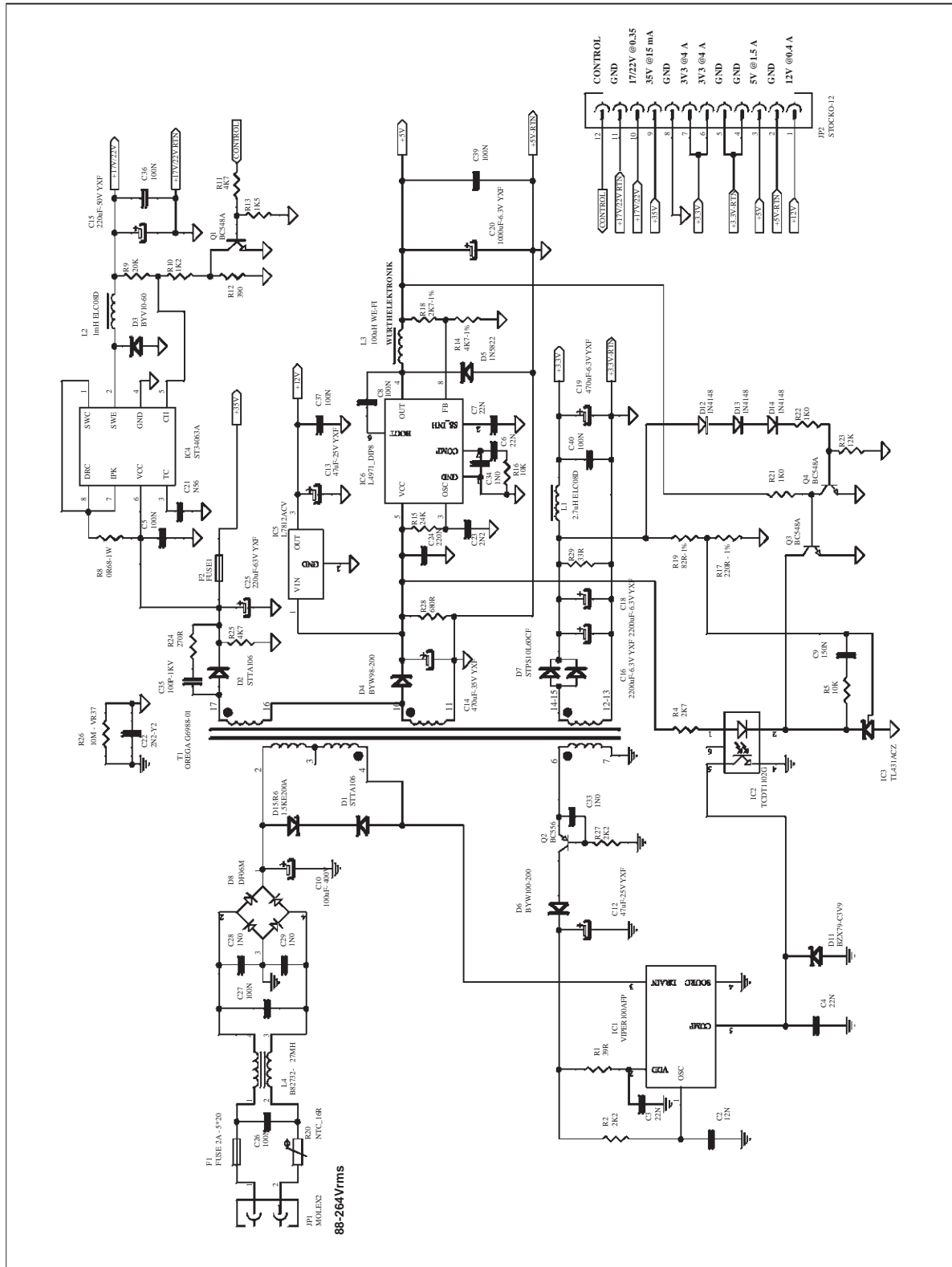

## AN1487 - APPLICATION NOTE

Here following some waveforms during the normal operation at full load:

**Figure 2:** Vds & Id at full load  
(Vin = 115 Vrms - 50 Hz)

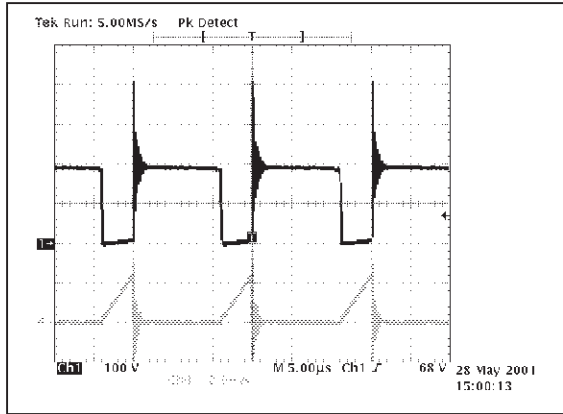

CH1:DRAIN VOLTAGE  
CH4:DRAIN CURRENT

**Figure 3:** Vds & Id at full load  
(Vin = 220 Vrms - 50 Hz)

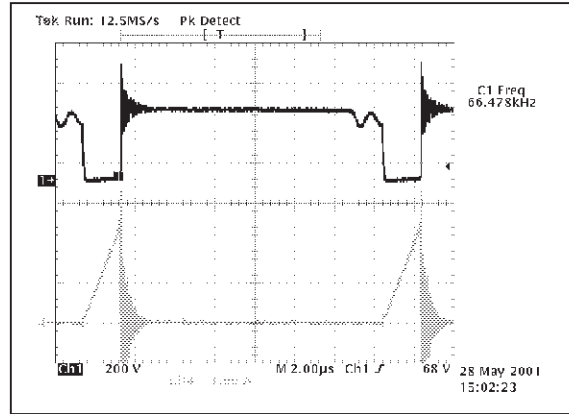

CH1:DRAIN VOLTAGE  
CH4:DRAIN CURRENT

Figure 4 gives the measurement of the drain peak voltage at full load and maximum input mains voltage. The maximum voltage peak is 596V, assuring a reliable operation of the VIPer100A with a good margin against the maximum BVDSS.

**Figure 4:** Vds & Id at full load  
(Vin = 265 Vrms - 50 Hz)

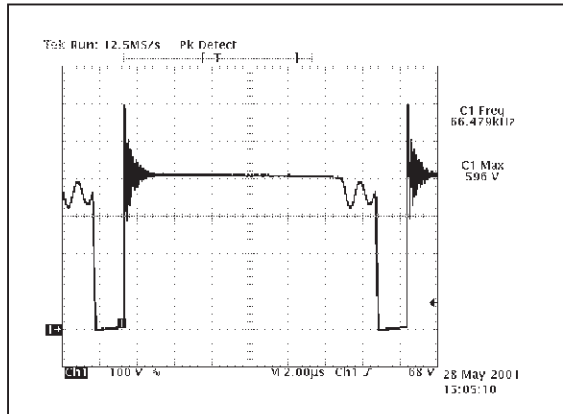

CH1:DRAIN VOLTAGE

The maximum PIV of the diodes has been measured during the worst operating condition and it is indicated on the right of figure 5 and figure 6. The margin, with respect to the maximum voltage sustained by the diodes, assures a safe operating condition for the devices.

Here following (figure 7 and figure 8), the most salient controller IC signals are depicted. In both the pictures is possible to distinguish clean waveforms free of hard spikes or noise that could affect the controller correct operation.

**Figure 5:** diode PIV at  $V_{in} = 265$  Vrms - 50 Hz, full load

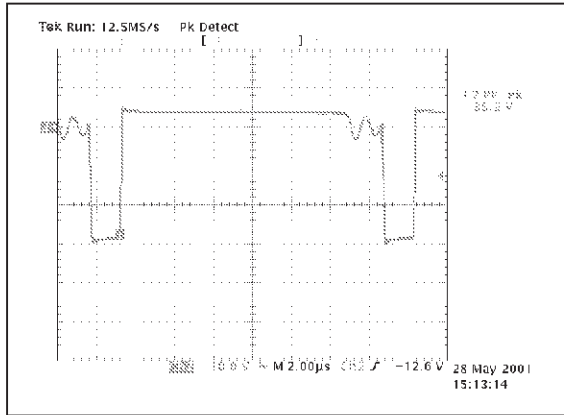

CH2:+3.3V DIODE: ANODE VOLTAGE

**Figure 6:** diode PIV at  $V_{in} = 265$  Vrms - 50 Hz, full load

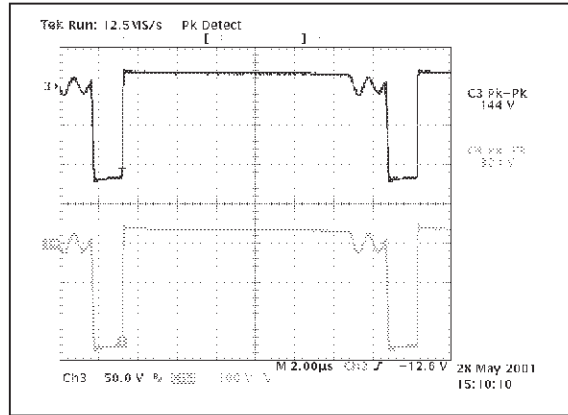

CH3:+15V DIODE: ANODE VOLTAGE  
CH4:+35 DIODE: ANODE VOLTAGE

**Figure 7:**  $V_{in} = 115$  Vrms - 50 Hz

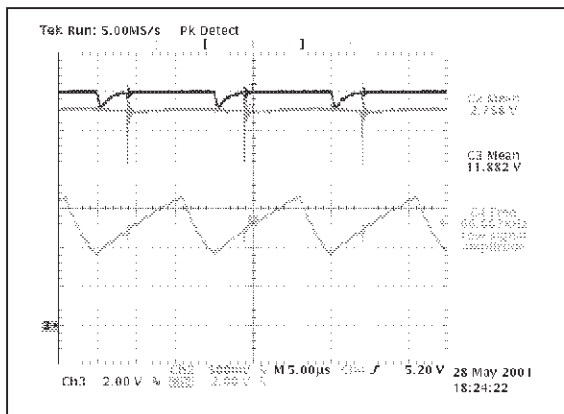

CH2:VPIN5 - VCOMP  
CH3:VPIN2 - VDD  
CH4:VPIN1 - VOSC

**Figure 8:**  $V_{in} = 220$  Vrms - 50 Hz

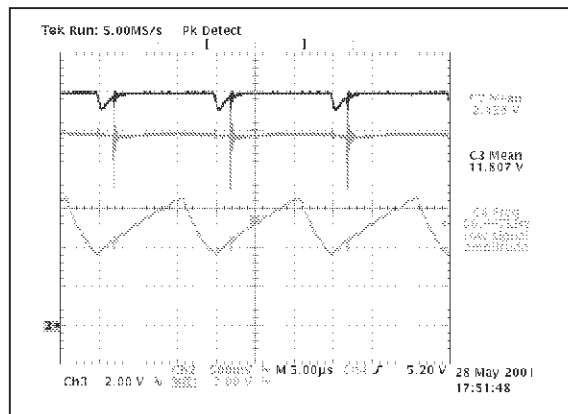

CH2:VPIN5 - VCOMP  
CH3:VPIN2 - VDD  
CH4:VPIN1 - VOSC

### 2.1 5V DC/DC Converter

In figure 9, the most relevant waveforms of the 5V-Buck converter at full load are shown. It is based on the L4971 a monolithic IC integrating the controller and a N-channel MOSFET. As indicated, the working frequency of this converter is fixed, 94 KHz (100KHz nominal) and it is programmable by the RC network R15/C23. The output voltage is selectable by the resistor divider R18/R14 and a soft-start time is programmable by C7. Thanks to the high frequency operation allowed by the L4971, the output inductor is a small, standard 100mH toroid. This value provides for the continuous mode operation of the inductor and a small ripple current, so requiring a capacitor without a very small ESR cheaper.

The diode is axial, Schottky type, rated to sustain the current in case of a long term short of the output.

## AN1487 - APPLICATION NOTE

**Figure 9:** 5V-Buck converter at full load waveforms

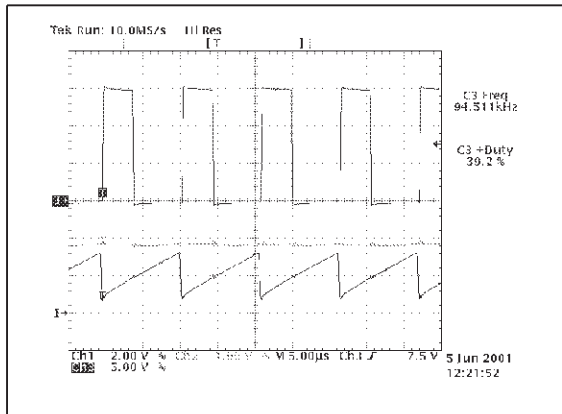

CH1:VPIN3 - VOSC  
 CH2:VPIN7 - VCOMP  
 CH3:VPIN4 - VOUT (Free Wheeling Diode)

**Figure 10:** ST34063 converter oscillator and chopped voltage

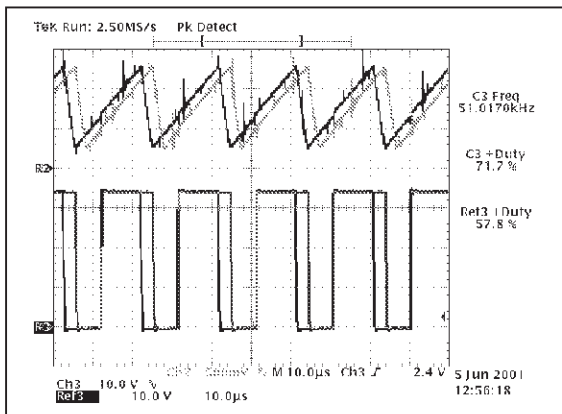

CH2:VPIN3 - VTC at 22V  
 R2:VPIN3 - VTC at 17V  
 CH3:VPIN2 - VSWE at 22V  
 R3:VPIN2 - VSWE at 17V

**Figure 11:** 17/25V output and set top box control voltage

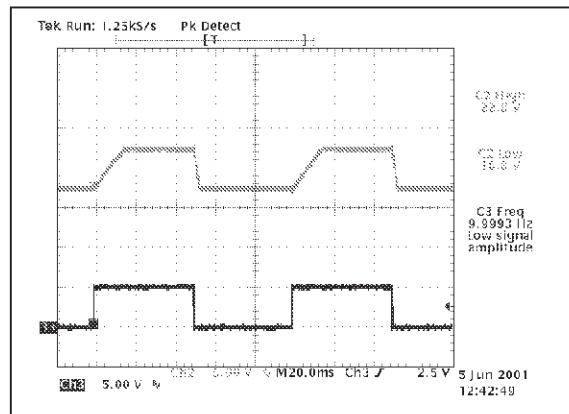

CH2:VOUT at FULL LOAD  
 CH3:VCONTROL

### 2.2 17/25V DC/DC Converter for LNB

The LNB converter is a Buck, based on the ST34063, a monolithic chip integrating the controller and a BJT as switch. It is a low cost device requiring just few components around it. The operation of this converter is variable frequency. The duty is imposed by the input/output voltage ratio like in any Buck converter. The operating frequency is imposed by the inductor charging/discharging time, hence by its value. The control loop is hysteretic, using an internal comparator. This converter is dedicated to the LNB linear regulators. Changing the converter output voltage by means of the Control signal it is possible to keep a constant voltage drop on the linear element, avoiding large heat sinks and dissipation. In figure 10, there are some significant waveforms, the oscillator saw tooth and the chopped voltage. In figure 11 there is the output voltage variation in accordance with the control pin. The output current of the converter is limited in case of short circuits.

**2.3 Cross regulation**

In the following tables the output voltage cross regulation is measured with static loads and the overall efficiency of the converter measured at different input voltages. If not differently mentioned, all the output voltages have been measured after the output connector and a 100 mm length cable, simulating the connection with the STB motherboard.

**Table 3:** Full load at Vin=115Vrms, Iin=0.67Arms

Vout [V] =	34.78	5.057	22.47	3.29	12.12			
Iout [A] =	0.016	1.500	0.352	4.057	0.402			
						<b>Pout<sub>TOT</sub> [W]</b>	<b>Pin [W]</b>	<b>EFF.</b>
Pout [W] =	0.550	7.586	7.909	13.348	4.872	<b>34.264</b>	<b>48.5</b>	<b>70.65%</b>
V <sub>C14</sub> [V] =	15.1							
V <sub>C12</sub> [V] =	12.37							

**Table 4:** Full load at Vin=220Vrms, Iin=0.4Arms

Vout [V] =	34.67	5.056	22.46	3.29	12.12			
Iout [A] =	0.016	1.500	0.352	4.057	0.402			
						<b>Pout<sub>TOT</sub> [W]</b>	<b>Pin [W]</b>	<b>EFF.</b>
Pout [W] =	0.548	7.584	7.906	13.348	4.872	<b>34.257</b>	<b>46.6</b>	<b>73.51%</b>
V <sub>C14</sub> [V] =	15.08							
V <sub>C12</sub> [V] =	12.35							

The efficiency of the converter is rather high thanks to the VIPer100A characteristics but it is affected by 5V and LNB dc/dc converters and by the 12V linear regulator.

**Table 5:** Reduced Load – 1 at Vin=115Vrms, Iin=0.5Arms

Vout [V] =	34.6	5.08	22.46	3.32	12.13			
Iout [A] =	0.007	1.00	0.25	3.06	0.3			
						<b>Pout<sub>TOT</sub> [W]</b>	<b>Pin [W]</b>	<b>EFF.</b>
Pout [W] =	0.255	5.080	5.615	10.159	3.639	<b>24.748</b>	<b>34.7</b>	<b>71.32%</b>
V <sub>C14</sub> [V] =	15.03							
V <sub>C12</sub> [V] =	12.25							

**Table 6:** Reduced Load – 1 at Vin=220Vrms, Iin=0.29Arms

Vout [V] =	34.6	5.08	22.46	3.32	12.13			
Iout [A] =	0.007	1.00	0.25	3.06	0.3			
						<b>Pout<sub>TOT</sub> [W]</b>	<b>Pin [W]</b>	<b>EFF.</b>
Pout [W] =	0.255	5.080	5.615	10.159	3.639	<b>24.748</b>	<b>34.0</b>	<b>72.79%</b>
V <sub>C14</sub> [V] =	15.00							
V <sub>C12</sub> [V] =	12.24							

## AN1487 - APPLICATION NOTE

**Table 7:** Reduced Load – 2 at Vin=115Vrms, Iin=0.35Arms

Vout [V] =	34.17	5.1	22.46	3.36	12.15			
Iout [A] =	0.007	0.75	0.18	1.98	0.203			
						<b>Pout<sub>TOT</sub></b>	<b>Pin [W]</b>	<b>EFF.</b>
Pout [W] =	0.248	3.825	4.043	6.653	2.466	<b>17.235</b>	<b>24.0</b>	<b>71.81%</b>
V <sub>C14</sub> [V] =	12.01							
V <sub>C12</sub> [V] =	14.82							

**Table 8:** Reduced Load – 2 at Vin=220Vrms, Iin=0.21Arms

Vout [V] =	34.2	5.1	22.46	3.36	12.15			
Iout [A] =	0.007	0.75	0.18	1.98	0.203			
						<b>Pout<sub>TOT</sub></b>	<b>Pin [W]</b>	<b>EFF.</b>
Pout [W] =	0.249	3.825	4.043	6.653	2.466	<b>17.236</b>	<b>23.8</b>	<b>72.42%</b>
V <sub>C14</sub> [V] =	12.43							
V <sub>C12</sub> [V] =	15.29							

**Table 9:** Reduced Load - for Cable STB, without the LNB and tuner loads at Vin=115Vrms, Iin=0.53Arms

Vout [V] =	42.2	5.06	22.49	3.29	12.11			
Iout [A] =	0	1.5	0.000	4.01	0.4			
						<b>Pout<sub>TOT</sub></b>	<b>Pin [W]</b>	<b>EFF.</b>
Pout [W] =	0.000	7.590	0.000	13.193	4.844	<b>25.627</b>	<b>37.9</b>	<b>67.62%</b>
V <sub>C14</sub> [V] =	15.3							
V <sub>C12</sub> [V] =	12.44							

**Table 10:** Reduced Load - for Cable STB, without the LNB and tuner loads at Vin=220Vrms, Iin=0.32Arms

Vout [V] =	42.5	5.06	22.49	3.28	12.11			
Iout [A] =	0	1.5	0.000	4.01	0.4			
						<b>Pout<sub>TOT</sub></b>	<b>Pin [W]</b>	<b>EFF.</b>
Pout [W] =	0.000	7.590	0.000	13.153	4.844	<b>25.587</b>	<b>37.0</b>	<b>69.15%</b>
V <sub>C14</sub> [V] =	12.43							
V <sub>C12</sub> [V] =	15.29							

The above tables shown the output voltage measured applying the same loads that we could have in case of a different Set-top Box type is powered (e.g. a terrestrial or cable) without the LNB block of the satellite antenna and the 35V for the tuner.

Like before all the regulated output voltages are within the tolerances.



**Table 11:** No-Load (Output connector unplug) at Vin=115Vrms

Vout [V] =	33	5.13	22.49	3.4	12.17		
Iout [A] =	0	0	0	0	0		
						<b>Pout<sub>TOT</sub> [W]</b>	<b>Pin [W]</b>
Pout [W] =	0.000	0.000	0.000	0.000	0.000	<b>0.000</b>	<b>1.8</b>
V <sub>C14</sub> [V] =	14.41						
V <sub>C12</sub> [V] =	9.33	<b>ALL VOLTAGES ARE WITHIN TOLERANCE</b>					

**Table 12:** No-Load (Output connector unplug) at Vin=220Vrms

Vout [V] =	33	5.13	22.49	3.4	12.17		
Iout [A] =	0	0	0	0	0		
						<b>Pout<sub>TOT</sub> [W]</b>	<b>Pin [W]</b>
Pout [W] =	0.000	0.000	0.000	0.000	0.000	<b>0.000</b>	<b>2.0</b>
V <sub>C14</sub> [V] =	14.41						
V <sub>C12</sub> [V] =	9.33	<b>ALL VOLTAGES ARE WITHIN TOLERANCE</b>					

2.4 VIPer100 waveforms at no load

**Figure 12:** Vin = 115 Vrms - 50 Hz

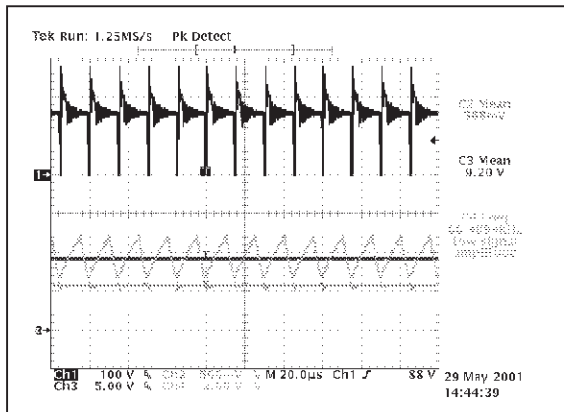

CH1:VPIN3 - VDS  
 CH2:VPIN5 - VCOMP  
 CH3:VPIN2 - VDD  
 CH4:VPIN1 - VOSC

**Figure 13:** Vin = 220 Vrms - 50 Hz

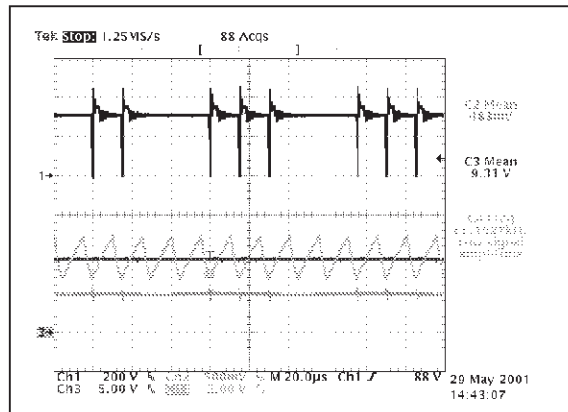

CH1:VPIN3 - VDS  
 CH2:VPIN5 - VCOMP  
 CH3:VPIN2 - VDD  
 CH4:VPIN1 - VOSC

Unplugging the output connector the circuit is still able to maintain all the voltages perfectly under control and within the tolerance. Hence, a perfect functionality of the circuit is achieved also in this abnormal condition. During the no load operation at higher mains range the circuit works in burst mode and, thanks to this controller functionality, it keeps the input power almost constant. This makes it suitable to support stand-by operation with low consumption from the mains. It has to be kept into account that this circuit it has not been optimised for the Stand-by operation hence it could be improved. For example, switching off the dc-dc converters and replacing the linear regulator with a similar one with Disable, a power consumption reduction is achieved. Of course, the consumption of the other output voltage loads has to be decreased in other ways, like switches or by dedicated disable pins.

## AN1487 - APPLICATION NOTE

**Figure 14:** Output voltage ripple 115 Vrms - 50Hz

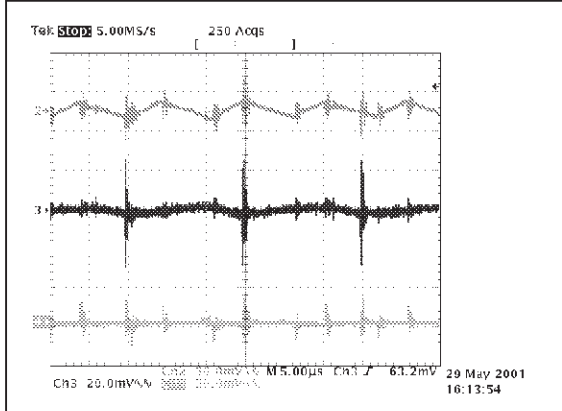

CH2:+5 Vout  
CH3:+3.3 Vout  
CH4:+12 Vout

**Figure 15:** Output voltage ripple 115 Vrms - 50Hz

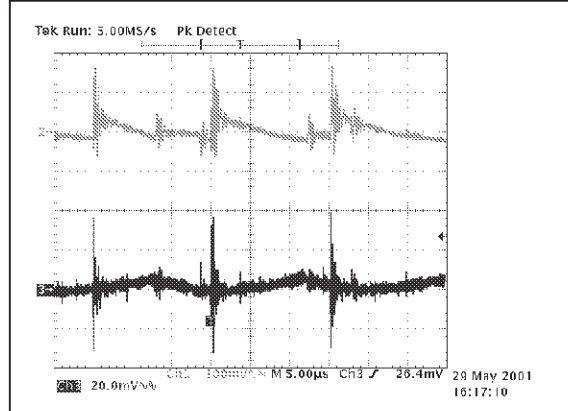

CH2:+35 Vout  
CH3:+17/22 Vout

**Figure 16:** Line frequency ripple at V115 Vrms 50Hz

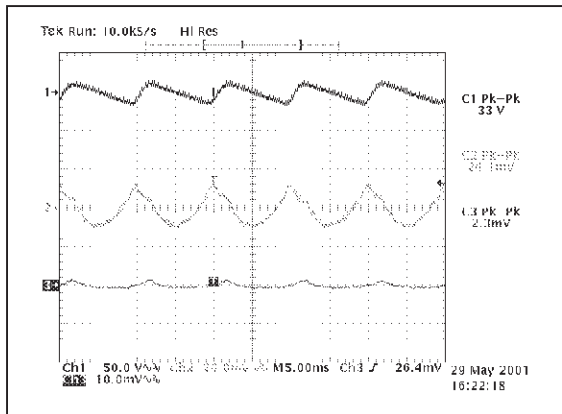

CH1:VPIN3 - VDS  
CH2:+35 Vout  
CH3:+3.3 Vout

**Figure 17:** 3.3V regulated output dynamic load variation at 220 Vrms 50 Hz

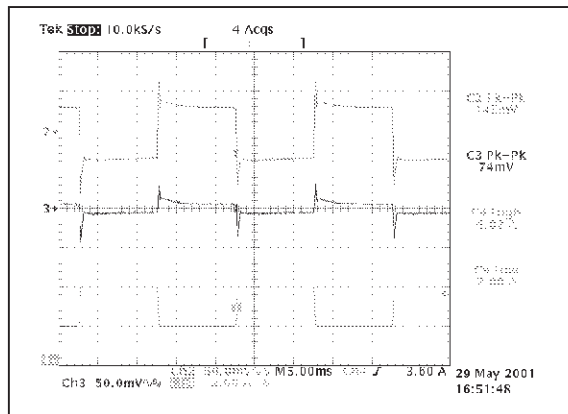

CH2:+3.3 Vout at test points  
CH3:+3.3 Vout before L1  
CH4:+3.3 Iout

### 3.0 OUTPUT VOLTAGE RIPPLE AT FULL LOAD

In figure 14 and figure 15, the output voltage ripple at switching and mains frequency are shown. As per the previous measures, the probes have been connected on test points after the connection cable.

### 4.0 LINE FREQUENCY RIPPLE

Thanks to the current mode and its voltage feed-forward, the low frequency residual ripple compared with the ripple across C10 (input Elcap) shows an excellent rejection of the control loop (>80 dB). In figure 16, the CH2 trace shows the rejection for the +35V output that is not regulated but it depends only from the transformer coupling. At 220Vac the rejection is even better, due to the lower ripple across the input capacitor.

**Figure 18:** 3.3V regulated output dynamic load variation at 220 Vrms - 50Hz

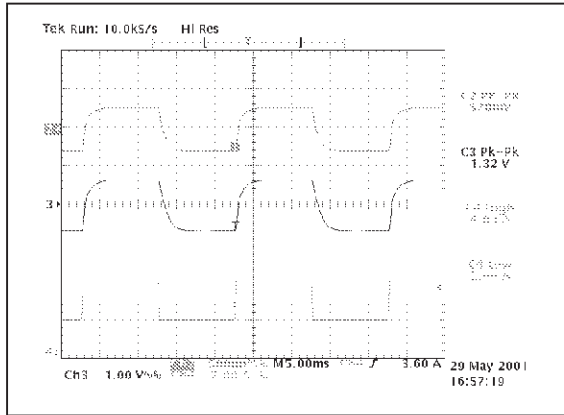

CH2:+15V - D4 ANODE  
 CH3:+35 Vout  
 CH4:+3.3 Iout

**Figure 19:** 3.3V regulated output dynamic load variation at 220 Vrms - 50Hz

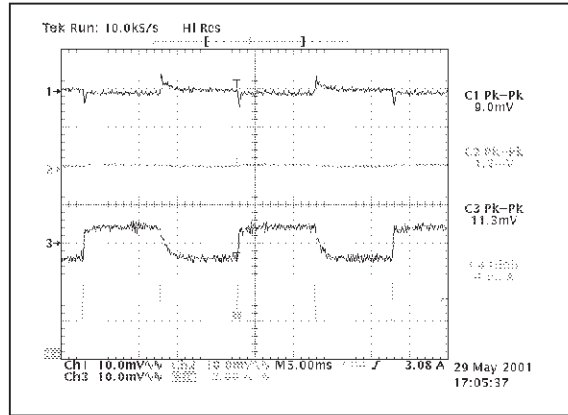

CH1:+5 Vout  
 CH2:+12 Vout  
 CH3:+17/22 Vout  
 CH4:+3.3 Iout

**5.0 DYNAMIC LOAD TESTS**

**5.1 +3.3V Regulated Output**

Load condition:	+5V, +12V, +17/22V, +35V	FULL LOAD
	+3,3V	LOAD 50% 100%, 50Hz

Figures 17, 18 and 19 show the output voltage regulation against a dynamic load variation of the feed backed voltage, at the nominal input voltage values. As shown in figure 17, the response after the connector is not very good, even if the response is quite fast. Making the same measure before the filter inductor (L1), at the feed back divider connection points, the response is much better ("2.2%). This means that the filter inductor heavily affect the response. To avoid any expensive solution to improve it, the better way is to measure the voltage regulation during the normal operation, powering the real load circuitry. This, because there are some local capacitors or filters helping a lot the regulation. Besides, normally the dynamic load changes are less than the testing value indicated.

The regulation for all the other output voltage is good. The +15V-unregulated output has a modulation not critical for both the linear and the switching regulator while it is more depth for the +35V output. Anyway, this variation is not critical for the varicap zener diodes dedicated to tuning.

The measures have been done at both the nominal mains voltages giving the same results.

**5.2 +5V Regulated Output**

Load condition:	+3.3V, +12V, +17/22V, +35V:	FULL LOAD
	+5V:	LOAD 50% 100%, 50Hz

The above test shows the response of the +5V output voltage varying its load as indicated. As visible in figure 20, the DC/DC converter provides for an excellent stability of the output voltage against the load variation. The variation of the 15V unregulated is around to 200 mV, then not critical for the 12V regulator.

The regulation has been tested at both the nominal mains voltages. At 115Vac the waveforms have the same amplitude.

## AN1487 - APPLICATION NOTE

**Figure 20:** 5V regulated output dynamic load variation at 220 Vrms - 50Hz

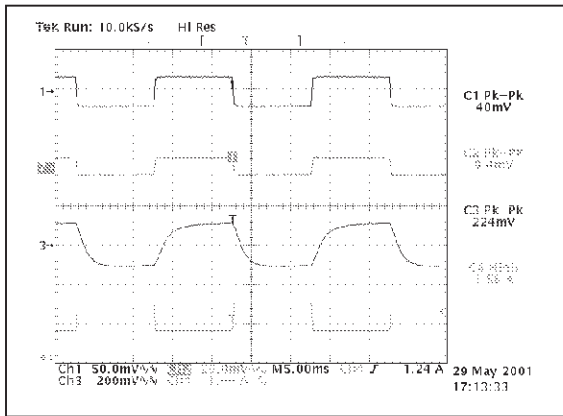

CH1: +5V Vout  
 CH2: +12V Vout  
 CH3: +35V Vout  
 CH4: +5V Iout

**Figure 21:** 17/22V regulated output dynamic load variation at 220 Vrms - 50Hz

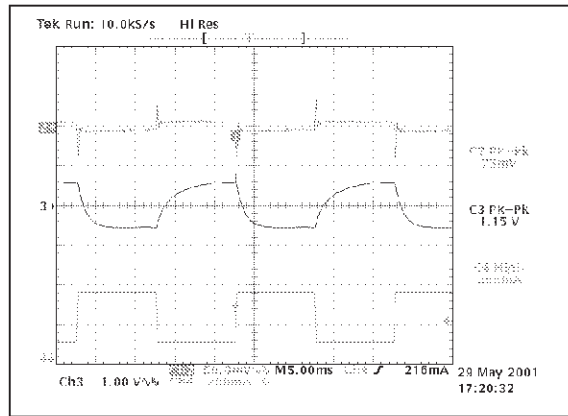

CH2: +17/22V Vout  
 CH3: +35V Vout  
 CH4: +17/22V Iout

### 5.3 +17/22V Regulated Output

Load condition:	+3.3V, +12V, +5V, +35V:	FULL LOAD
	+17/22V:	LOAD 50% 100%, 50Hz

Even the LNB converter has a very good regulation against load variations. As in the figure 21, the voltage variation is only 75 mV.

### 6.0 START-UP BEHAVIORS AT FULL LOAD

**Figure 22:** 220 VAC - 50Hz

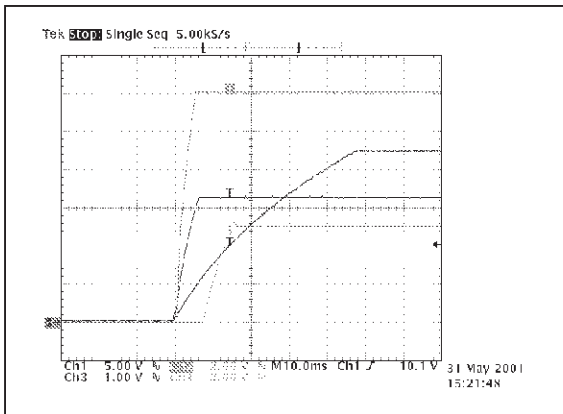

CH1: +17/22 Vout  
 CH2: +12 Vout  
 CH3: +3.3 Vout  
 CH4: +5 Vout

In figure 22, there are the rising slopes at full load of the more significant output voltages at 220Vac input mains voltage. As shown in the picture, the rising times are constant and there is only a difference for the 5V and 17/22V rise time, with respect to the other outputs. The phenomenon is due to the delay introduced by the two DC/DC converter that need time for start-up. The circuit has been tested at minimum, nominal and maximum input mains voltage. The behavior is the same in all conditions with a monotonic slope and free of overshoot.

**7.0 WAKE-UP TIME**

In figures 23 and 24, there are the waveforms with the wake-up time measured at minimum and maximum input mains. As measured, thanks to the VIPer100A internal current source, the capacitor C12 is charged with a constant current, independent from the input mains value. This means that the power supply wake-up time is perfectly constant and it can be smaller and so cheaper. Thus, the annoying problem of a very long start-up time, especially at low mains, is solved without to add any additional extra component like with controller not integrating the HV start-up functionality. Besides, it is a key circuit during stand-by operation because it is disconnected from the mains saving power.

The measured time at 85 and 265 Vac is 237 ms, which is rather fast for this kind of Power Supplies.

**8.0 TURN-OFF AT FULL LOAD**

Even at turn off the transition is clean, without any abnormal behavior like restart or glitches both on the primary or secondary side.

**9.0 SHORT-CIRCUIT TESTS AT FULL LOAD**

In a power supply the short circuit protection is a very important function because it involves the safety of the equipment powered and it can be the source of annoying problems during the equipment qualification phase. A frequent problem with universal mains input converters is a not constant behavior of the protection overall the input voltage range. In fact, we have to protect the shorted output components and the primary side switch from overheating or melting because during short the average output current can be very high as well as the power involved at primary side.

To limit the power involved in fault condition avoiding any inexpensive component over sizing a common solution adopted by the controllers is the so called hic-cup mode functionality, So, if a short happens, the reflected low impedance provides for the auxiliary voltage disappearing and consequently the controller is off.

Figure 23: 85 VAC - 50Hz

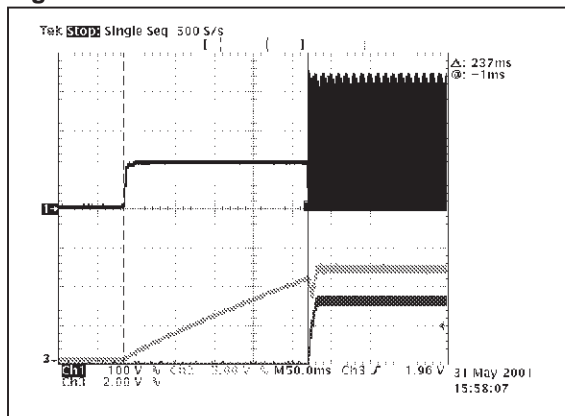

CH1:VDD  
CH2:VC12 (Vaux)  
CH3:+3V3 Vout

Figure 24: 265 VAC - 50Hz

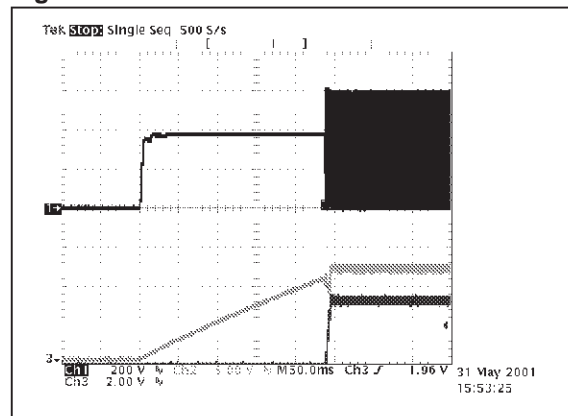

CH1:VDD  
CH2:VC12 (Vaux)  
CH3:+3V3 Vout

Then it restarts with a normal start-up phase and its time constant, then it works until the fault is detected again and a new cycle is triggered. The on-off working ratio provides for the average power delivering

## AN1487 - APPLICATION NOTE

Figure 25: 115 VAC - 50Hz

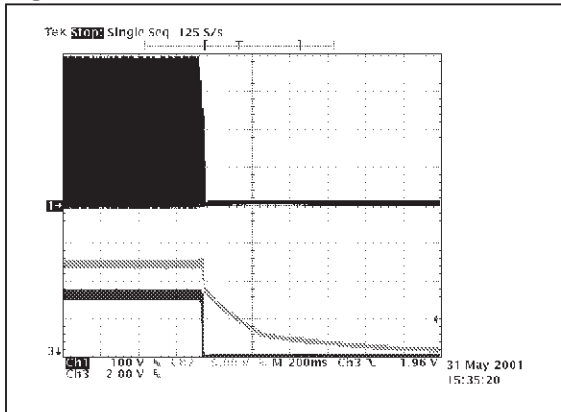

CH1:VDD  
CH2:VC12 (Vaux)  
CH3:+3V3 Vout

Figure 26: 220 VAC - 50Hz

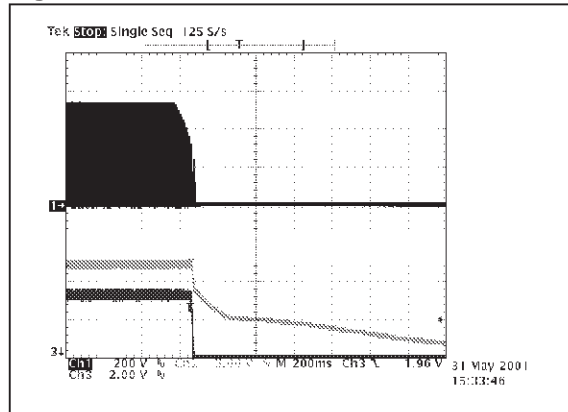

CH1:VDD  
CH2:VC12 (Vaux)  
CH3:+3V3 Vout

limitation. However, sometimes, using old concept controllers may happen that at low mains a good, low frequency hic-cup mode is achieved, but it becomes inefficient at high mains. This is due to the auxiliary capacitor charging by a simple resistor, providing for the effect of a charging time proportional to the input mains voltage and the result is an hic-cup with an on-off working ratio not short enough to limit the output diode dissipation of the shorted output also at high mains.

The consequence in case of long-term shorts is a catastrophic failure for the circuit due to the rectifier overheating.

Thanks to the VIPer integrated start-up current source, the circuit behavior is very similar overall the input voltages range because, like during the start-up phase, the Vcc capacitor is charged at constant current. This internal functionality eliminates definitively the problem of a poor short circuit protection bringing a superior safety level of the circuit against circuit fault. Moreover, no any circuit over sizing of neither the power semiconductor nor the heat sinks is required so saving additional costs.

On the board the short circuit tests have been done testing the circuit at maximum and minimum and nominal input voltage, but to avoid the insertion of a high amount of similar pictures, only the most significant have been inserted. The circuit parameters checked in all conditions have been the drain voltage and the mean value of the output current. The drain voltage is an important parameter to check during shorts at maximum input voltage to insure the reliability against long term-shorts. This because, especially with RCD clamped networks on the trafo primary, the effect of an higher peak of the primary current due to the heavier output load during the short charges the leakage inductance with more energy than during the normal operation, then an higher spike can appear on the Mosfet drain. If the spike exceeds the BVDS and the avalanche capability or the clamping diode VRRM, we have the circuit destruction.

Using the VIPer, thanks to the easy clamping of the E/A and the maximum power deliverable, this problem can be easily managed. Moreover, in this design, a TRANSIL clamp has been used and it's the best solution to avoid over voltages on the drain because it clamps almost at a constant level differently to a RCD clamped. Hence, in the left pictures and the following ones it is easy to check that during shorts the current has a value close or less to the nominal one, and the Drain voltage peak is always well below the BVDS, so preventing component melting for excessive dissipation. The auto-restart of the circuit has been also checked and it is correct at short removal for all conditions.

In figure 27, find the VIPer most significant control waveforms during the hic-cup mode operation: it is possible to check the Auxiliary voltage ramp across C12 due to its charging and discharging and the Comp pin voltage. This last trace gives an idea about the clamping of the Comp pin by the zener diode D11: the voltage peak is 3.54V while its maximum value can rise up 4.5V, so limiting the output power deliverable to the output.

The short circuit has also been checked for the other transformer output (figure 28 and figure 29) and for all the SMPS post regulated outputs. In order to check the transformer behavior the measurement of the transformer output voltages during a short has been done. This because the transformer coupling may

cause an unpredictable voltage variation, that is dependent on the current flowing in each winding. As shown in figures 30, 31, 32 and 33 all the output voltages remain at low values, thanks to the good coupling between the transformer windings.

Figure 27: 265 Vrms

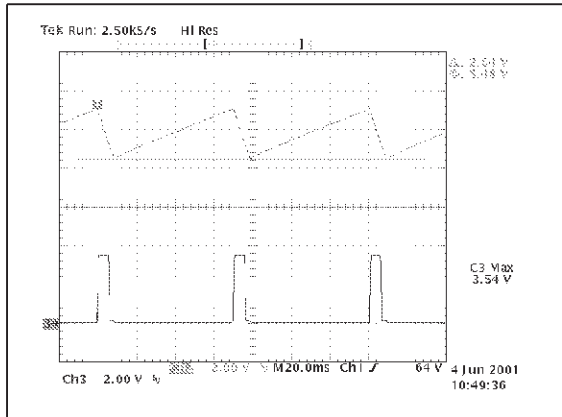

CH2:VC12 (Vaux)  
CH3:VPIN5 - VCOMP

### 9.1 Post-regulated Outputs

Like the other output, both the two controllers keep under control the circuit preventing in all conditions the circuit from catastrophic failures. The L4971 dedicate to 5V regulation during short limits the current and the overheating working in burst-mode. The working time in this case is dependent on the impedance of the short circuit, thus always limiting the components overstress.

The ST34063 instead limits the duty cycle at its minimum value when the output current exceeds the threshold set by the sensing resistor R8.

Figure 28: 15V TRAF0 OUTPUT SHORT- 85 Vrms

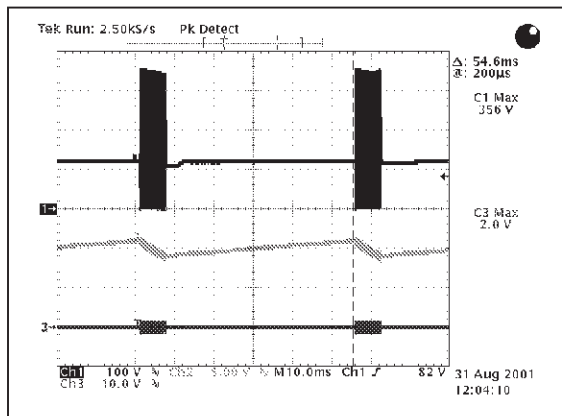

CH1:DRAIN VOLTAGE  
CH2:VC12 (Vaux)  
CH3:VC14 (+15V)  
CH4:ISHORT CIRCUIT

Figure 29: 15V TRAF0 OUTPUT SHORT- 265 Vrms

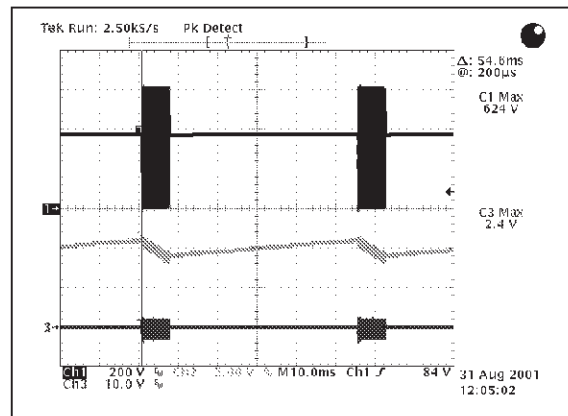

CH1:DRAIN VOLTAGE  
CH2:VC12 (Vaux)  
CH3:VC14 (+15V)  
CH4:ISHORT CIRCUIT

## AN1487 - APPLICATION NOTE

**Figure 30: +3.3/+35V OUTPUTS: SHORT at 265 Vrms - SHORT C19 (+3.3V)**

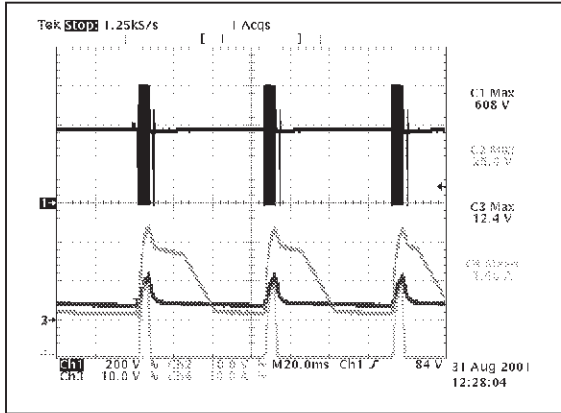

CH1: DRAIN VOLTAGE  
 CH2: C25 VOLTAGE (+35V)  
 CH3: C14 VOLTAGE (+15V)  
 CH4 :ISHORT CIRCUIT

**Figure 31: +3.3/+35V OUTPUTS: SHORT at 265 Vrms - SHORT C25 (+35V)**

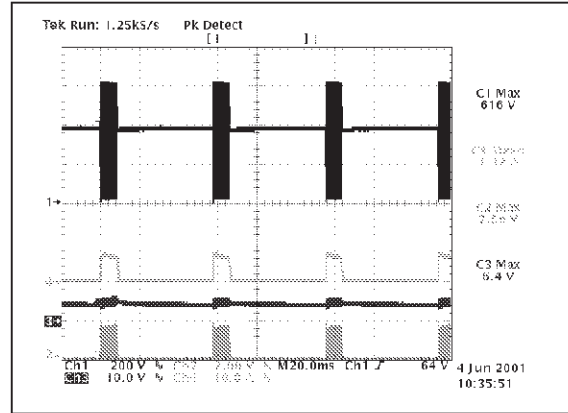

CH1: DRAIN VOLTAGE  
 CH2: 3.3Vout  
 CH3: C14 VOLTAGE (+15V)  
 CH4: ISHORT CIRCUIT

**Figure 32: SHORT at 220 Vrms - SHORT C20 (+5V)**

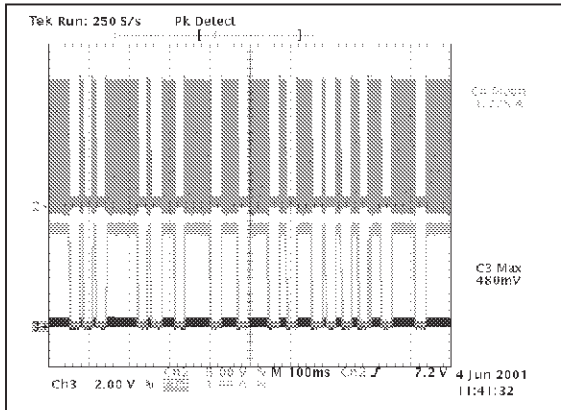

CH2:VD5  
 CH3:+3V3 Vout  
 CH4:ISHORT CIRCUIT

**Figure 33: SHORT at 220 Vrms - SHORT C15 (+17/22V)**

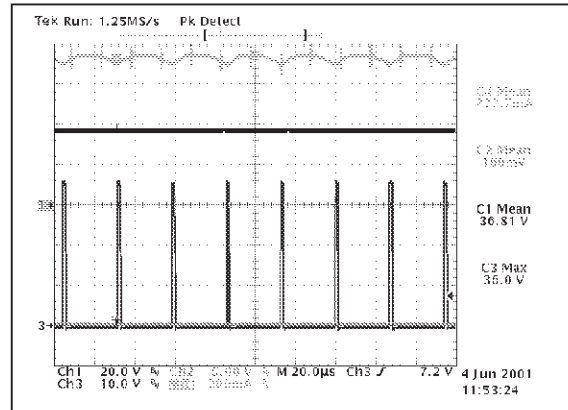

CH1:+3V3 Vout  
 CH2:+17/22 Vout  
 CH3:VD3  
 CH4:ISHORT CIRCUIT

### 9.2 12V Output short

A short circuit on this output is not able to provide for the hic-cup working mode of the primary controller and the current is limited by the linear regulator L78M12.

### 9.3 +35V Output short

A short on this output provides of course the same behavior of a short of C25 as shown before. The circuit starts work in burst mode protecting the circuit component from overstress as shown before.



**10.0 SHORT CIRCUIT PROTECTION AT LOW LOAD**

After the full load tests some additional checks on the short circuit protection with reduced loads have been done.

**10.1 Half Load**

35V	12V	17/22V	5V	3.3V
7.5mA	0.2 A	0.175A	0.75A	2A
Pout <sub>TOT</sub> = 12.6W				

At Vin=115Vac: shorting each output by the active load the over current protection works correctly, providing for the hic-cup working mode. The hic-cup mode intervention is obtained even shorting the unregulated voltages (+15V and +35V) at the transformer output. Both the DC/DC converters protect the circuits like tested before as well as the 12V linear regulator limits the output current.

At Vin=220Vac: the circuit behaves like at 115V.

**10.2 Reduced Load - No LNB and Tuner voltages loaded**

35V	12V	17/22V	5V	3.3V
0mA	0.4 A	0A	1.5A	4A
Pout <sub>TOT</sub> = 12.6W				

Even in this condition, all the SMPS output voltages are protected on all the input voltage range. Decreasing the load of the output delivering current the output current protection works still correctly.

**11.0 SHORT CIRCUIT PROTECTION WITHOUT LOAD**

This condition is the worst case for most of the power supply. In fact the coupling between the windings in this case changes the circuit behavior, while the low peak current at primary side sometimes is not able to trigger the controllers protection circuits. Even in this abnormal condition the circuit performs well, working in burst mode like at full load. As visible on figure 34, the most salient parameters are measured showing that the circuit components are still working inside their rating and with margin, so insuring a good reliability. In figure 35 and figure 36, the measure results for the others transformer outputs are shown .

**12.0 SWITCH ON AND TURN OFF IN SHORT CIRCUIT CONDITION**

- FULL LOAD
- SHORT ON 3V3

Figure 37 and figure 38 describe the SMPS behavior during the start-up phase with an output voltage shorted. As clearly visible the circuit starts correctly then it works in hic-cup mode protecting itself. The start-up phase is clean in all conditions, without showing any dangerous transition for the SMPS circuitry. Even at turn off in short circuit the SMPS functionalities are good, protecting properly the circuit. No any abnormal transition or level has been observed during the tests.

## AN1487 - APPLICATION NOTE

**Figure 34: +3V3 OUTPUT: SHORT at 265 Vrms**

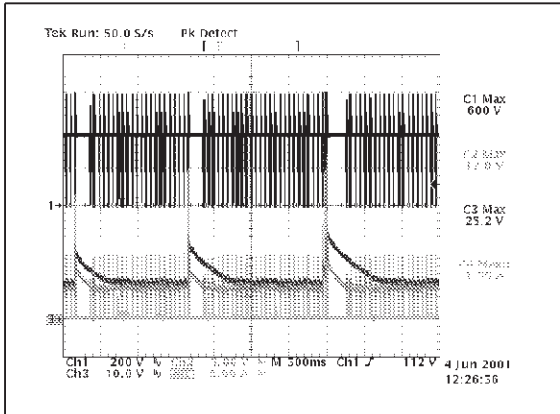

CH1:DRAIN VOLTAGE  
 CH2:VC14 (+15V)  
 CH3:VC25 (+35V)  
 CH4:ISHORT CIRCUIT

### 13.0 OPEN LOOP PROTECTION

In any SMPS a dangerous fault that could happen is the so called Open Loop operation, due to a failure of the feedback network. If unprotected, in this condition the SMPS can deliver output voltages much higher than the nominal values destroying the SMPS and the load. Using the Viper with a secondary feedback the solution for this problem is integrated in the Viper and free of charge: in fact just using the internal error amplifier dedicated to primary feedback and designing properly the auxiliary winding of the transformer it is possible to protect the circuit without adding any additional external component to the circuit.

**Figure 35: +15V OUTPUT: SHORT at 265 Vrms**

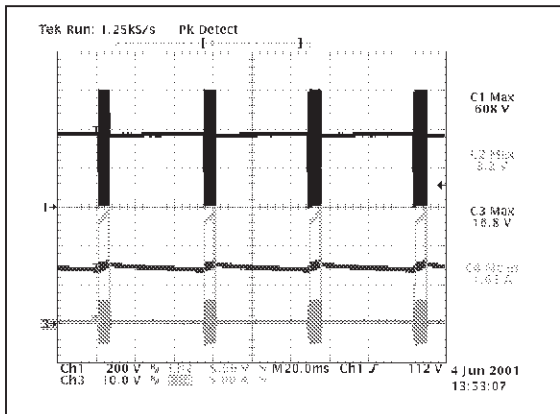

CH1:DRAIN VOLTAGE  
 CH2:VC14 (+15V)  
 CH3:VC25 (+35V)  
 CH4:ISHORT CIRCUIT

**Figure 36: +35V OUTPUT: SHORT at 265 Vrms**

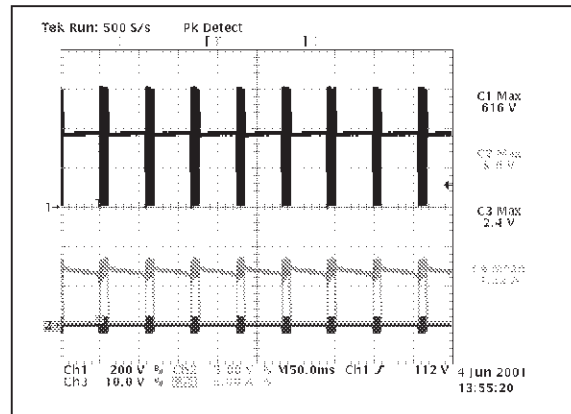

CH1:DRAIN VOLTAGE  
 CH2:VC14 (+15V)  
 CH3:VC25 (+35V)  
 CH4:ISHORT CIRCUIT

Figure 37: START at 220 Vrms - 50Hz

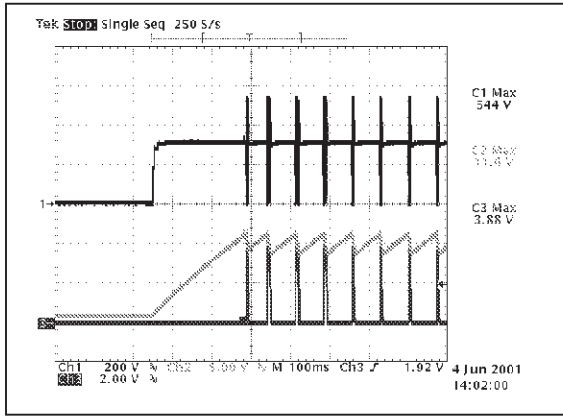

CH1:VDD  
 CH2:VC11 (Vaux)  
 CH3:VPIN5 - VCOMP

Figure 38: TURN-OFF at 220 Vrms - 50Hz

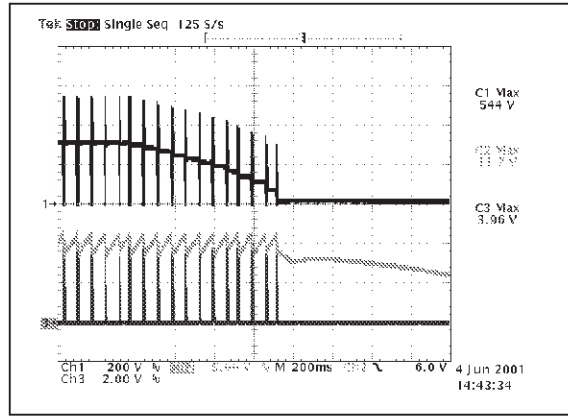

CH1:VDD  
 CH2:VC11 (Vaux)  
 CH3:VPIN5 - VCOMP

The measures have given the following results, overall the input voltage range:

Nominal Voltages	35V	15V	3V3	V <sub>C12</sub>
Open Loop at Full Load	38.2V	16.4V	3.6V	13.4V
Open Loop at No load	47V	20.5V	4.8V	13.4V

In both condition the measured voltages are not critical for the circuitry. Obviously, only the transformer voltages have been measured because the post-regulators keep their output voltages at the nominal value even in this condition.

#### 14.0 EMI CONDUCTED NOISE MEASUREMENTS (PRE-COMPLIANCE TEST)

The following pictures (figure 39 and figure 40) are the quasi-peak conducted noise measurements at full load and nominal mains voltages. The limits shown on the diagrams are the EN55022 CLASS B, which is the most widely rule for domestic equipments like a STB. As visible on the diagrams, there is a good margin of the measures with respect to the limits. Please note that the limit to be considered on the diagrams is the higher line.

<b>Limits: EN55022 - CLASS B</b>
<b>QUASI-PEAK MEASURE</b>
Start freq.: 150 kHz
Stop freq.: 30Mhz

## AN1487 - APPLICATION NOTE

Figure 35:  $V_{in} = 115 \text{ Vrms}$  50 Hz - FULL LOAD

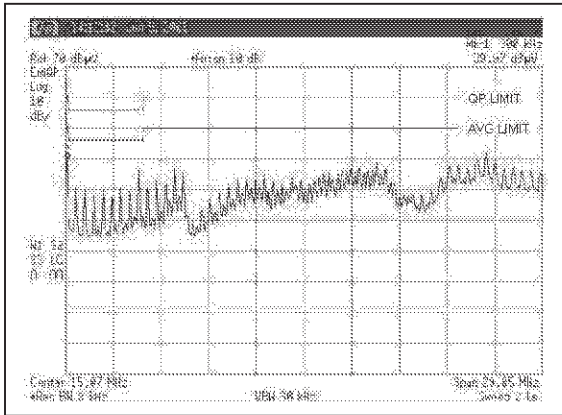

CH1:DRAIN VOLTAGE  
CH2:VC14 (+15V)  
CH3:VC25 (+35V)  
CH4:ISHORT CIRCUIT

Figure 36:  $V_{in} = 220 \text{ Vrms}$  50 Hz - FULL LOAD

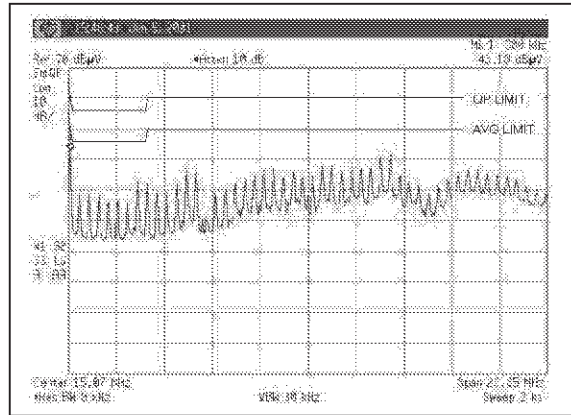

CH1:DRAIN VOLTAGE  
CH2:VC14 (+15V)  
CH3:VC25 (+35V)  
CH4:ISHORT CIRCUIT

### 15.0 CONCLUSION

A complete SMPS dedicated to digital set-top boxes has been designed, assembled and completely tested. The results show that it is reliable and suitable to meet the current international rules for similar equipments, meeting also a low-cost, complexity and volume and good performances as requested by the market.

## Annex 1: Component List

Ref.	Part Type	Description	Supplier
C10	100uF- 400V	ELCAP	ELNA
C12	47uF-25V YXF	ELCAP	RUBYCON
C13	47uF-25V YXF	ELCAP	RUBYCON
C14	470uF-35V YXF	ELCAP	RUBYCON
C15	220uF-50V YXF	ELCAP	RUBYCON
C16	2200uF-6.3V YXF	ELCAP	RUBYCON
C18	2200uF-6.3V YXF	ELCAP	RUBYCON
C19	470uF-6.3V YXF	ELCAP	RUBYCON
C2	12N	CERCAP	AVX
C20	1000uF-6.3V YXF	ELCAP	RUBYCON
C21	N56	CERCAP	AVX
C22	2N2-4KV (Y2) 44LD22	CERCAP-SAFETY	CERA-MITE
C23	2N2	CERCAP	AVX
C24	220N	CERCAP	AVX
C25	220uF-63V YXF	ELCAP	RUBYCON
C26	100N-275Vac - B81133	X CAP	EPCOS
C27	100N-275Vac - B81133	X CAP	EPCOS
C28	1N0-1KV 30LVD10	CERCAP HV	CERA-MITE
C29	1N0-1KV 30LVD10	CERCAP HV	CERA-MITE
C3	22N	CERCAP	AVX
C33	1N0	CERCAP	AVX
C34	1N0	CERCAP	AVX
C35	100PF-1KV HRR	CERCAP HV	MURATA
C36	100N	CERCAP	AVX
C37	100N	CERCAP	AVX
C39	100N	CERCAP	AVX
C4	22N	CERCAP	AVX
C40	100N	CERCAP	AVX
C5	100N	CERCAP	AVX
C6	22N	CERCAP	AVX
C7	22N	CERCAP	AVX
C8	100N	CERCAP	AVX
C9	150N	CERCAP	AVX

## AN1487 - APPLICATION NOTE

### Annex 1: Component List (continued)

D1	STTA106	ULTRA FAST REC. RECTIFIER	<b>STMicroelectronics</b>
D11	BZX79-C3V9	ZENER DIODE	PHILIPS
D12	1N4148	GEN. PURPOSE DIODE	WISHAY
D13	1N4148	GEN. PURPOSE DIODE	WISHAY
D14	1N4148	GEN. PURPOSE DIODE	WISHAY
D15/	1.5KE200A	TRANSIL	<b>STMicroelectronics</b>
D2	STTA106	ULTRA FAST REC. RECTIFIER	<b>STMicroelectronics</b>
D3	BYV10-60	SCHOTTKY RECTIFIER	<b>STMicroelectronics</b>
D4	BYW98-200	FAST REC. RECTIFIER	<b>STMicroelectronics</b>
D5	1N5822	SCHOTTKY RECTIFIER	<b>STMicroelectronics</b>
D6	BYW100-200	FAST REC. RECTIFIER	<b>STMicroelectronics</b>
D7	STPS10L60CF	POWER SCHOTTKY RECTIFIER	<b>STMicroelectronics</b>
D8	DF06M	BRIDGE RECTIFIER	GEN. SEMICOND.
F1	FUSE 2A - 5*20		
F2	NOT USED - SHORTED		
IC1	VIPer100AFP	INTEGRATED CONTROLLER	<b>STMicroelectronics</b>
IC2	TCDT1102G	OPTOCOUPLER	VISHAY TELEFUNKEN
IC3	TL431ACZ	SHUNT REGULATOR	<b>STMicroelectronics</b>
IC4	ST34063A	DC-DC CONVERTER	<b>STMicroelectronics</b>
IC5	L7812ACV	LINEAR REGULATOR	<b>STMicroelectronics</b>
IC6	L4971_DIP8	STEP-DOWN SWITCHING REG.	<b>STMicroelectronics</b>
JP1	39-26-3030	2 POLES CONNECTOR	MOLEX
JP2	MKS1862-6-0-1212	12 POLES CONNECTOR	STOCKO
L1	2.7uH ELC08D	INDUCTOR	PANASONIC
L2	1mH ELC08D	INDUCTOR	PANASONIC
L3	WE-FI 744 70 21	100uH-2A INDUCTOR	WURTH ELECTRONIK
L4	B82732-R2901-B30	2*27mH FILTER COIL	EPCOS
Q1	BC548A	SMALL SIGNAL BJT	ZETEX
Q2	BC556	SMALL SIGNAL BJT	ZETEX
Q3	BC548A	SMALL SIGNAL BJT	ZETEX
Q4	BC548A	SMALL SIGNAL BJT	ZETEX
R1	39R - 1/4W - 5%	SFR25	BEYSCHLAG
R10	1K2 - 1/4W - 5%	SFR25	BEYSCHLAG
R11	4K7 - 1/4W - 5%	SFR25	BEYSCHLAG
R12	390 - 1/4W - 5%	SFR25	BEYSCHLAG

## Annex 1: Component List (continued)

R13	1K5 - 1/4W - 5%	SFR25	BEYSCHLAG
R14	4K7 - 1/4W - 1%	MBA0204	BEYSCHLAG
R15	24K - 1/4W - 5%	SFR25	BEYSCHLAG
R16	10K - 1/4W - 5%	SFR25	BEYSCHLAG
R17	220R - 1/4W - 1%	MBA0204	BEYSCHLAG
R18	2K7 - 1/4W - 1%	MBA0204	BEYSCHLAG
R19	82R - 1/4W - 1%	MBA0204	BEYSCHLAG
R2	2K2 - 1/4W - 5%	SFR25	BEYSCHLAG
R20	NTC_16R S236	NTC THERMISTOR	EPCOS
R21	1K0 - 1/4W - 5%	SFR25	BEYSCHLAG
R22	1K0 - 1/4W - 5%	SFR25	BEYSCHLAG
R23	12K - 1/4W - 5%	SFR25	BEYSCHLAG
R24	270R - 1/4W - 5%	SFR25	BEYSCHLAG
R25	4K7 - 1/4W - 5%	SFR25	BEYSCHLAG
R26	10M - 1W - 5%	VR37	BEYSCHLAG
R27	2K2 - 1/4W - 5%	SFR25	BEYSCHLAG
R28	680R - 1/4W - 5%	SFR25	BEYSCHLAG
R29	33R - 1/4W - 5%	SFR25	BEYSCHLAG
R4	2K7 - 1/4W - 5%	SFR25	BEYSCHLAG
R5	10K - 1/4W - 5%	SFR25	BEYSCHLAG
R8	0R68-1W - 5%	PR01	BEYSCHLAG
R9	20K - 1/4W - 5%	SFR25	BEYSCHLAG
T1	G6988-01	POWER TRANSFORMER	OREGA
HS1	6099B	HEAT SINK FOR IC1	THERMALLOY
HS2	6099B	HEAT SINK FOR D7	THERMALLOY
HS3	6043PB	HEAT SINK FOR IC5	THERMALLOY

**AN1487 - APPLICATION NOTE**

**ANNEX2: Transformer Specification**

		SMT 18		40346-XX	
		SPF : G 6988-01			A
S.T. MICROELECTRONICS		Customer code			
<b>Switch Mode Transformer OREGA For SET TOP BOX DEMOBOARD</b>					
<b>CONTENTS</b>					
Items				Pages	
CHARACTERISTICS.....				2	
OUTPUT CHARACTERISTICS.....				3	
MECHANICAL CHARACTERISTICS.....				4	
MATERIAL LIST.....				5	
SAFETY.....				6	
MARKING.....				7	
PACKAGING.....				8	
RELIABILITY SPECIFICATION.....				REF P 014	
<b>MODIFICATION / APPROBATION</b>					
Ice	Date	Subject	Customer	Prod./Proc.	Quality
A	17.07.2001	First edition (based on G 6988-01)		D. ESCUDERO	
<b>OREGA</b>		PRODUCT SPECIFICATION		Page	1/9

Reproduction in any form without THOMSON's written consent is prohibited.



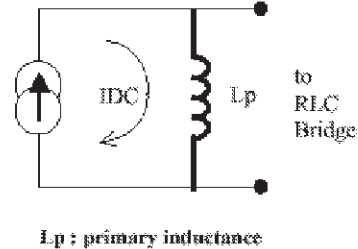
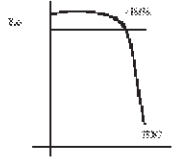

ANNEX2: Transformer Specification (continued)

<b>THOMSON</b> <small>MIKROELECTRONIKA</small>		<b>SMT 18</b>	<b>40346-XX</b>
		<b>SPF : G 6988-01</b>	
<b><u>CHARACTERISTICS</u></b>			
<p>Unless otherwise specified, the standard range of atmospheric conditions for making measurements and tes is as follows :</p> <ul style="list-style-type: none"> <li>- Ambient temperature : 25°C ± 5°C</li> <li>- Relative humidity : 45% to 85 %</li> <li>- Air pressure : 860 hPa to 1060 hPa.</li> </ul>			
<b><u>ELECTRICAL CHARACTERISTICS</u></b>			
	ITEMS	CONDITIONS	SPECIFICATIONS
1	Primary inductance	Measuring points : 2 and 4 Measuring frequency : 1 kHz Applied voltage : 250 mV	$L_p = 246 \mu\text{H} \pm 10 \%$
2	Leakage inductance	Measuring points 2 and 4 Measuring frequency 10 kHz (All secondaries short circuited)	Typical value
3	DC superimposed current	 <p style="text-align: center;"><math>L_p</math> : primary inductance</p>	$L = L_0 \times 0.9$ for $I_{\text{sat}} = 3.35 \text{ A}$ at 100°C 
4	Max. primary power		55 W
5	Operating voltage		85 - 265 Vac
6	Operating frequency		70 kHz
7	Controller circuit		Viper 100
8	Regulation Mode		Secondary
<b>OREGA</b>		PRODUCT SPECIFICATION	Page 7/9

Reproduction is not permitted without THOMSON MIKROELECTRONIKA copyright consent

**AN1487 - APPLICATION NOTE**

**ANNEX2: Transformer Specification (continued)**

<b>THOMSON</b> <small>MARKET MEDIA</small>		<b>SMT 18</b>	<b>40346-XX</b>
		<b>SPF : G 6988-01</b>	
		<b>A</b>	
<b>OUTPUT CHARACTERISTICS</b>			
Pins	Value	Loads	Remarks
(14/15) - (12/13)	+ 3.9 V	4 A	B+
10 - 11	+ 16 V	1,1 A	
16 - 17	+ 35.8V	0,3 A	
6 - 7	Vcc		
2 - 4	Primary		
<b>CIRCUIT DIAGRAM</b>			
<p style="text-align: center;">PRIMARY SIDE</p>		<p style="text-align: center;">SECONDARY SIDE</p>	
<b>OREGA</b>	PRODUCT SPECIFICATION	Page	3/9
R&D Tel: +33-12183186 ext.3100 - Fax: +33(0)121831832 Reproduktion ist nicht permitted without THOMSON's written consent			



ANNEX2: Transformer Specification (continued)

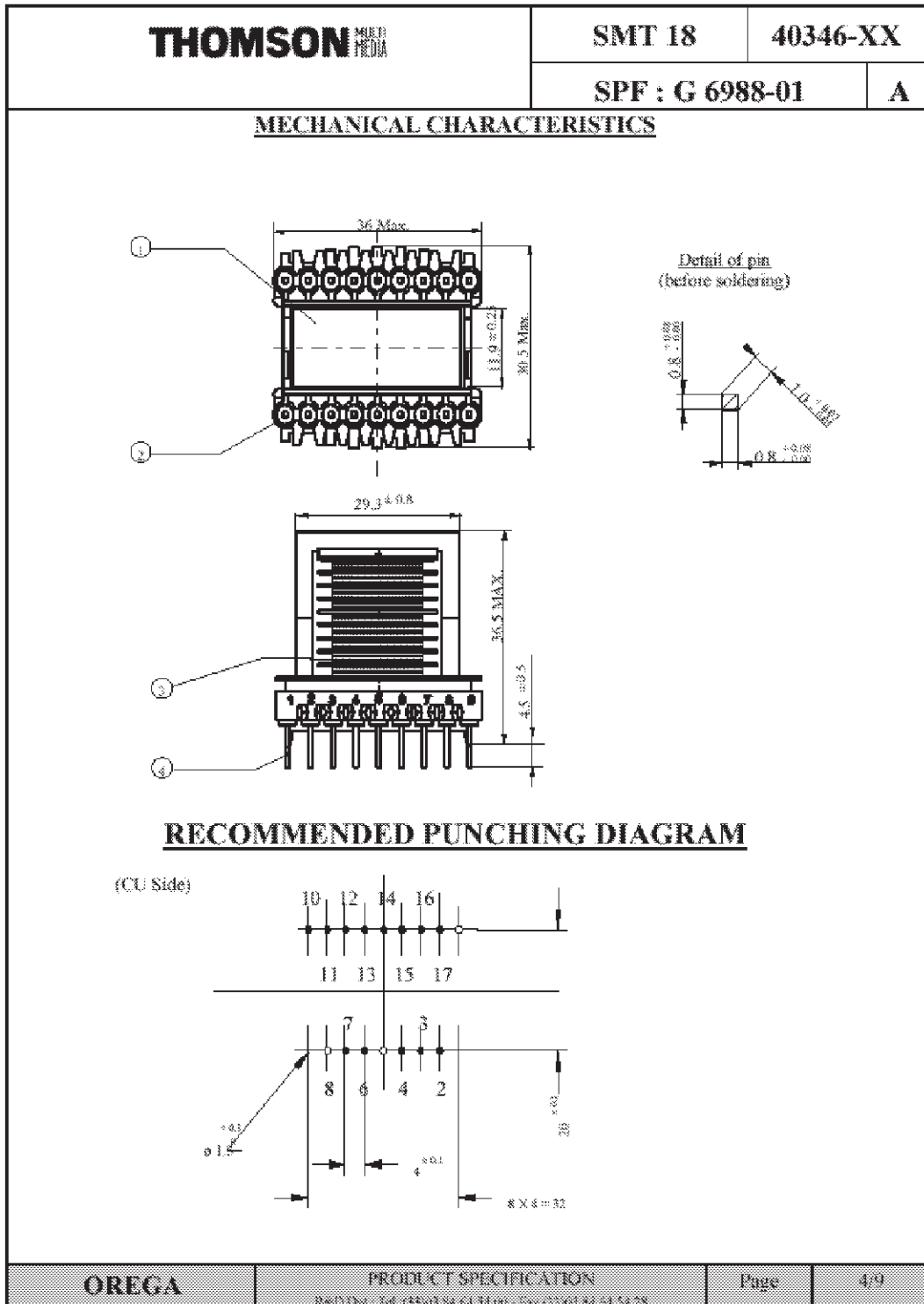

## AN1487 - APPLICATION NOTE





### ANNEX2: Transformer Specification (continued)

<b>THOMSON</b> <small>POWER ELECTRONICS</small>				SMT 18		40346-XX	
				SPF : G 6988-01			
<u>MATERIAL LIST</u>							
Designation	Reference	Material	Supplier	Generation compound	Standards certification	U.L. rating	
Ferrite core	E 19x18x13	$Al = 180 \mu H \pm 6 \%$ $I_s > 1.4 \text{ A at } 25^\circ C \pm 3^\circ C$ $I_s > 1.25 \text{ A at } 100^\circ C \pm 5^\circ C$ on test coil 100 turns					
Former		Kynite FR515	Dupont de Nemours	P E T	UL : E 69578 M	94 V0 0.86	
Winding		Enamelled wire Grade 2	Alcatel cuivre	Copper	UL : E 67139 M IEC 317.21	155° MW 80 C	
<b>OREGA</b>		PRODUCT SPECIFICATION				Page	5/9

REPRODUCED BY THE AUTHOR WITHOUT THOMSON'S PERMISSION. Reproduction is not permitted without THOMSON'S written consent.



ANNEX2: Transformer Specification (continued)

		SMT 18	40346-XX
		SPF : G 6988-01	
<u><b>SAFETY</b></u>			
	ITEMS	CONDITIONS	SPECIFICATIONS
1	Thickness of insulation.	Minimum thickness between the primary and the secondary windings for the plastic bobbin.	IEC 65 (last edition)
2	Dielectric strength	Dielectric strength between primary and secondary windings	IEC 65 (last edition)
3	Safety standard approval	EN 60065 : 1998	VDE Certified N° 
		clause 14.3.2a	BSI Certified N° : 8141
		UL 1411	EI70525
4	Creepage distances and clearances.	primary wire versus secondary wire	IEC 65 (Last edition = 4 mm)
		primary wire & secondary wire versus ferrite core	IEC 65 (Last edition = 2 mm)
  			

© 2012 STMicroelectronics - Reproduction is not permitted without THOMSON MICROELECTRONICS' explicit consent

**AN1487 - APPLICATION NOTE**

**ANNEX2: Transformer Specification (continued)**

	SMT 18	40346-XX
	SPF : G 6988-01	A

**MARKING**  
(by ink or label)

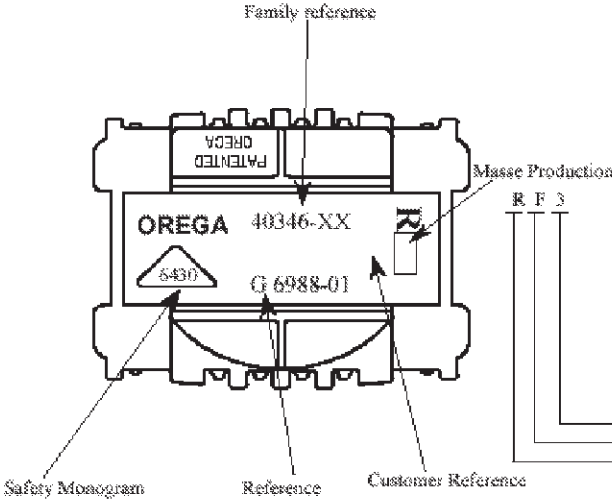

Family reference

Masse Production

R F S

Safety Monogram

Reference

Customer Reference

1 = January	E = 1994
2 = February	F = 1995
3 = March	G = 1996
4 = April	H = 1997
5 = May	K = 1998
6 = June	L = 1999
7 = July	M = 2000
8 = August	N = 2001
9 = September	P = 2002
O = October	R = 2003
N = November	S = 2004
D = December	T = 2005

R means Gisy Plant  
T means Torreon Plant

OREGA	PRODUCT SPECIFICATION	Page	7/9
REG. Dep. Tel. (33) 03 86 64 53 31 - Fax (33) 03 86 64 54 28 reproduction is not permitted without THOMSON S.A.'S prior written consent			

ANNEX2: Transformer Specification (continued)

	SMT 18	40346-XX
	SPF : G 6988-01	

**PACKAGING**

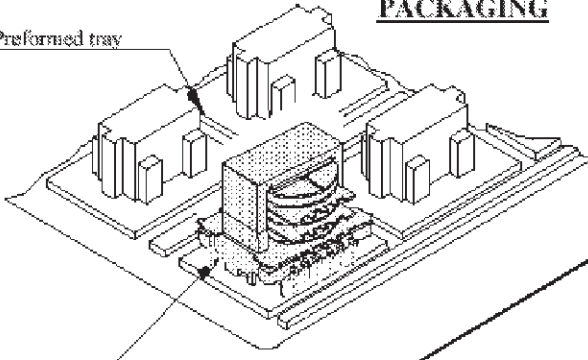

Preformed tray

SMT

1 preformed tray (cover)

4 preformed trays of 48 pieces

THOMSON CONSUMER ELECTRONICS INC.  
THOMSON TELEPHONES EQUIPEMENTS FRANCE

REF.: G 6988-01

QTY.: \_\_\_\_\_

APPROVAL:

**PACKAGING**

- Single piece weight = 44 g
- 192 pieces per box
- Total box weight = 9.8 Kg

**SHIPMENT**

- Europallet (1200 x 800 mm)
- 24 Boxes per pallet
- Total quantity = 4608 pieces
- Total weight 275 Kg

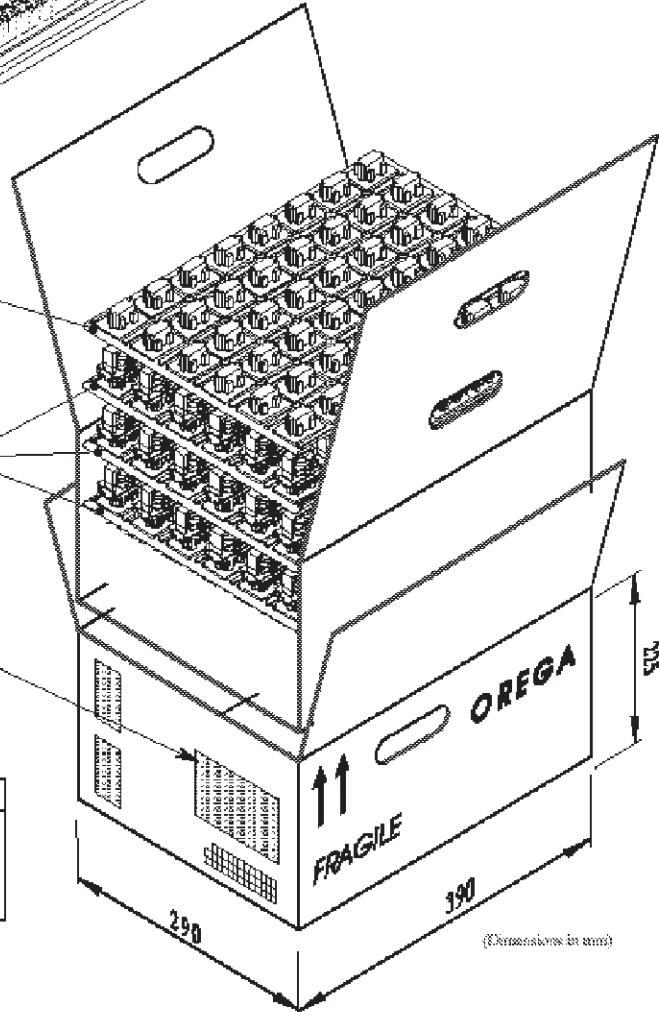

(Dimensions in mm)

Information furnished is believed to be accurate and reliable. However, STMicroelectronics assumes no responsibility for the consequences of use of such information nor for any infringement of patents or other rights of third parties which may result from its use. No license is granted by implication or otherwise under any patent or patent rights of STMicroelectronics. Specifications mentioned in this publication are subject to change without notice. This publication supersedes and replaces all information previously supplied. STMicroelectronics products are not authorized for use as critical components in life support devices or systems without express written approval of STMicroelectronics.  
The ST logo is a registered trademark of STMicroelectronics

© 2001 STMicroelectronics - Printed in ITALY- All Rights Reserved.

STMicroelectronics GROUP OF COMPANIES  
Australia - Brazil - China - Finland - France - Germany - Hong Kong - India - Italy - Japan - Malaysia - Malta -  
Morocco - Singapore - Spain - Sweden - Switzerland - United Kingdom - U.S.A.

<http://www.st.com>