

ALQ07 DC-DC Converter

Technical Reference Notes

Industry Standard Size – 36-75V Input, 3.3V/1.8V, 3.3V/1.5V and 3.3V/1.2V dual Output



Industry Standard Size: 2.28"X 1.45" X 0.43"package

Features

- **2.28"X1.45" X0.43"package**
- **Basic isolation**
- **High power density**
- **2:1 wide input of 36-75V**
- **CNT function**
- **Trim function**
- **Input under-voltage lockout**
- **Output over-current protection**
- **Output over-voltage protection**
- **Wide operating case temperature range**

Options

Choice of positive logic or negative logic for CNT function

Choice of short pins or long pins

Description

The ALQ07 series is a new open frame DC-DC converter. It is one of the most effective options available in component power. The ALQ07 series uses an industry standard package size: 36.8mm×57.9mm×10.9mm (2.28"×1.45"×0.43") and standard pin-out configuration, provides CNT and trim functions.

ALQ07 series comes in 48V input versions, each of which uses a 2:1 input range of 36~75V. The series can provide 3.3V@6A+1.8V@4A, 3.3V@6A+1.5V@4A and 3.3V@6A+1.2V@4A dual output, and output is isolated from input. And the converters are capable of providing up to 30 watts of output power.

Contents

Options	1
Description.....	1
Module Numbering	4
Electrical Specifications	5
Input Specifications	5
Absolute Maximum Ratings	6
Output Specifications.....	7
Output Specifications (Cont.).....	8
Feature Specifications	9
Characteristic Curves	10
Performance Curves – Efficiency	10
Performance Curves – Output Performance Curves	11
Performance Curves – Transient Response.....	12
Performance Curves – Transient Response (Cont.).....	13
Performance Curves – Transient Response (Cont.).....	14
Performance Curves – Startup Characteristics.....	15
Performance Curves – Startup from CNT Control	16
Feature Description	17
CNT Function	17
Trim	18
Minimum Load Requirements.....	19
Output Over-current Protection.....	19
Output Over-voltage Protection	19
Over Temperature Protection	19
Output Filters	19
Decoupling	20
Ground Loops.....	20
Design Consideration	21
Typical Application.....	21
Fusing.....	21
Input Reverse Voltage Protection	22
EMC	22
Safety Consideration	24
Thermal Consideration	25
MTBF	25
Mechanical Considerations.....	26
Installation	26

Soldering26

Mechanical Chart (pin side view).....27

Ordering Information.....28

Module Numbering

A L Q 07 FM 48 N- 7
1 2 3 4 5 6 7 8

Explanation:

1—Series name

2—Low profile

3—Quarter brick

4—Output current: 7A

5—Dual output: F: 3.3V, M: 1.5V, Y: 1.8V

6—Input voltage range: 36V to 72V

7—CNT logic, N---Negative enable, default is positive enable

8—Pin length:

6---3.80mm

8---2.80mm

7---5.8mm

By default: 5mm

Electrical Specifications

Unless otherwise indicated, specifications apply over all operating input voltage and temperature conditions. Standard test condition on a single unit is as following:

Ta(ambient):	25 °C
+Vin:	48V ± 2%
-Vin:	return pin for +Vin
CNT:	connect to COM for negative logic produce open for positive logic produce
+Vo1, +Vo2:	connect to load
COM:	connect to load (return)
Trim(Vadj):	open

Input Specifications

Parameter	Device	Symbol	Min	Typ.	Max	Unit
Operating Input Voltage	All	V_I	36	48	75	Vdc
Maximum Input Current ($V_I = 0$ to $V_{I,max}$, $I_o = I_{o,max}$)	All	$I_{I,max}$	-	-	1	A
Input Reflected-ripple Current (5Hz to 20MHz: 12 μ H source impedance: Ta = 25 °C.)	All	I_I	-	-	10	mAp-p
No Load Input Power ($V_I = V_{I,nom}$)	All	-	-	-	3.3	W

CAUTION: This power module is not internally fused. An input line fuse must always be used.

Absolute Maximum Ratings

Stresses in excess of the absolute maximum ratings can cause permanent damage to the device. These are absolute stress ratings only. Functional operation of the device is not implied at these or any other conditions in excess of those given in the operational sections of the IPS. Exposure to absolute maximum ratings for extended periods can adversely affect device reliability.

Parameter		Device	Symbol	Min	Typ.	Max	Unit
Input Voltage	Continuous:	All	V_I	0	-	80	Vdc
	Transient (100ms)	All	$V_{I,trans}$	0	-	100	Vdc
Operating Ambient Temperature		All	T_a	-40	-	60	°C
Storage Temperature		All	T_{STG}	-55	-	125	°C
Operating Humidity		All	-	-	-	95	%
Basic Input-Output Isolation (Conditions: 50 μ A for 5 sec, slew rate of 1500V/10sec)		All	-	-	-	1,500	Vdc
Output Power		All	$P_{o,max}$	-	-	30	W

Output Specifications

Parameter	Device	Symbol	Min	Typ	Max	Unit	
Output Ripple and Noise (When measure ripple, noise and dynamic response, external 10uF tantalum capacitor and 0.1uF ceramic capacitor required for each output.) Peak-to-Peak (5 Hz to 20 MHz)	All	Vo1	-	-	Ripple 50	Noise 50 mVp-p	
		Vo2	-	-	50	50 mVp-p	
External Load Capacitance	All	Vo1	0	-	4000	μ F	
		Vo2	0	-	4000	μ F	
Output Voltage Setpoint (Rating input, 3.3V@4A+1.8V@6A, 3.3V@4A+1.5V@6A,3.3V@4A+1.2V@6A, Ta = 25 °C)	ALQ07FY	Vo1 _{set}	3.25	3.3	3.35	Vdc	
		Vo2 _{set}	1.77	1.8	1.83	Vdc	
	ALQ07FM	Vo1 _{set}	3.25	3.3	3.35	Vdc	
		Vo2 _{set}	1.48	1.5	1.52	Vdc	
	ALQ07FK	Vo1 _{set}	3.25	3.3	3.35	Vdc	
		Vo2 _{set}	1.18	1.2	1.22	Vdc	
Cross regulation (Any one output Vs. others)	All				0.5	%V _{o,nom}	
Output Regulation: Line (Vi=Vi,min to Vi,max) Load (Io = Io,min to Io,max, other Io =50%Io,nom) (Ta=-40 °C~60°C)	All (Line Regulation)	Vo1	-	5	8	mV	
		Vo2	-	3	5	mV	
	All (Load Regulation)	Vo1			10	15	mV
		Vo2			5	10	mV
Rated Output Current (Io1+Io2≤10A)	All	Io1	0	-	6	A	
		Io2	0	-	7	A	
Output Current Protection (When unit is shut down)	All	Io1+ Io2	11	-	15	A	
Efficiency (Rating input,3.3V@6A, 1.8V/1.5V/1.2V@0A ; Ta = 25°C)	ALQ07FY	-	80		82	%	
	ALQ07FM	-	80		82	%	
	ALQ07FK	-	80		82	%	
Switching Frequency	All	-		360		kHz	

Output Specifications (Cont.)

Parameter		Device	Symbol	Min	Typ	Max	Unit
Dynamic Response*: ($\Delta I_o/\Delta t = 1A/\mu s$; $V_I = V_{I,nom}$; $T_a = 25^\circ C$)	Load Change from $I_o = 50\%$ to 75% of $I_{o,max}$, when the other output current is $50\% I_{o,nom}$	All	-	-	-	5	$\%V_o$
	Peak Deviation Settling Time (to $V_{o,nom}$)	All	-	-	-	200	μsec
	Load Change from $I_o = 50\%$ to 25% of $I_{o,max}$, when the other output current is $50\% I_{o,nom}$.	All	-	-	-	5	$\%V_o$
	Peak Deviation Settling Time (to $V_{o,nom}$)	All	-	-	-	200	μsec
Turn-On Time		All	-		5	10	msec
Output Voltage Overshoot (3.3V@6A, 1.8V@4A, 3.3V@6A, 1.5V@4A, 3.3V@6A, 1.2V@4A $T_a = 25^\circ C$)		All	Vo1		0	3	$\%V_o$
			Vo2		0	5	$\%V_o$

 **Note:**

The output capacitance 220uF+220uF tantalum (Each capacitor ESR < 100m Ω) may be used to meet the specified dynamic response.

Feature Specifications

Parameter		Device	Symbol	Min	Typ	Max	Unit
Enable pin voltage	Logic Low	All		-0.7	-	1.8	V
	Logic High	All		3.5	-	12	V
Enable pin current (Logic Low)		All		-	-	2.0	mA
Output Voltage Adjustment Range		All	Vo2	80	-	110	%V _{onom}
Over Temperature Protect		All	T	101		115	°C
Output Over-voltage (latch)		All	Vo1	3.90	-	5.00	V
			Vo2(1.8V)	2.20	-	2.60	V
			Vo2(1.5V)	1.80	-	2.26	V
			Vo2(1.2V)	1.45	-	1.80	V
Under-voltage Lockout	Turn-on Point	All	-	31	34	36	V
	Turn-off Point	All	-	30	33	35	V
Isolation Capacitance		All	-	-	1500	-	pF
Isolation Resistance		All	-	10	-	-	MΩ
Calculated MTBF (I _o = I _{o,max} ; T _a = 25°C)		All	-	-	1,800,000	-	Hours
Weight		All	-	-	-	30	g

Characteristic Curves

Performance Curves – Efficiency

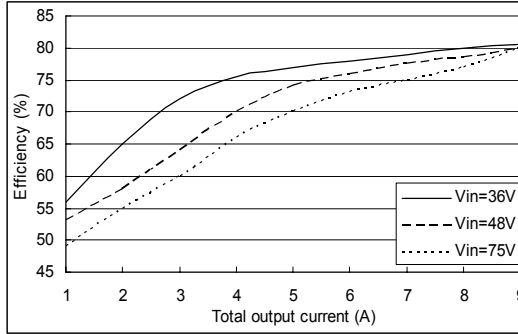

Typical Efficiency ALQ07FY*

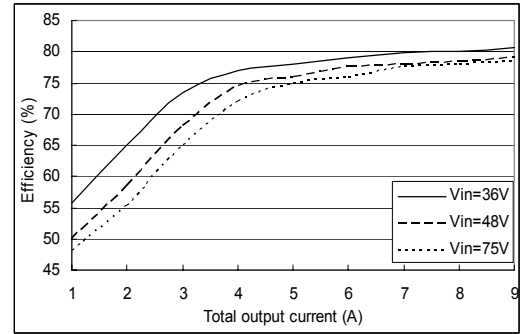

Typical Efficiency ALQ07FM*

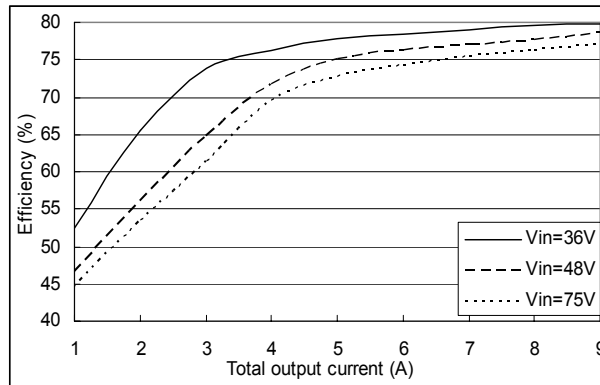

Typical Efficiency ALQ07FK*

 **Note:**

Both I_{o1} and I_{o2} increase by 10% until $I_{o1}+I_{o2}=10A$

Performance Curves – Output Performance Curves

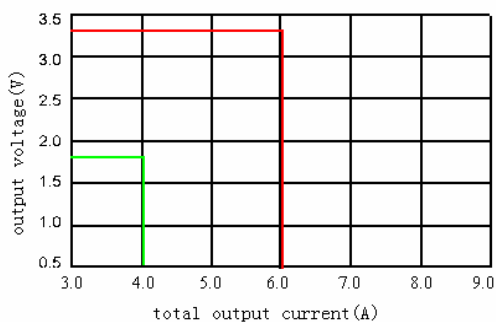

Typical Output Over-current ALQ07FY*

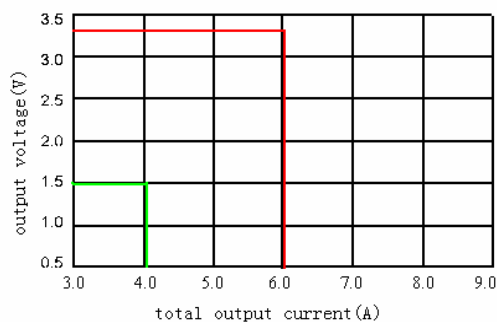

Typical Output Over-current ALQ07FM*

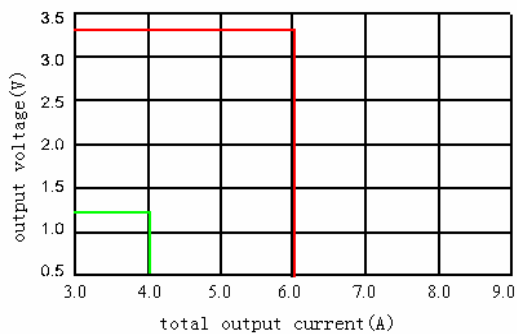

Typical Output Over-current ALQ07FK*

 **Note:**

When $I_{o1} + I_{o2} \geq 10A$, the module will shut down

Performance Curves – Transient Response

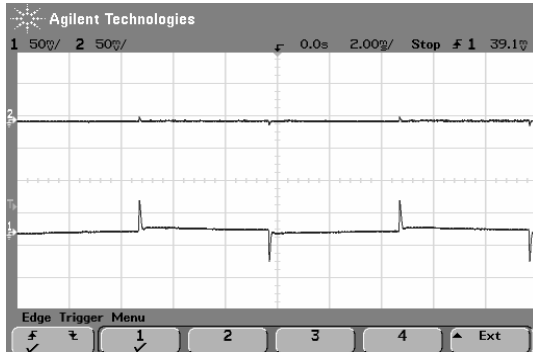

ALQ07FY 25%-50%-25% $I_{o1,nom}$ (I_{o1})
load change, $I_{o2} = 50\%I_{o2,nom}$ (ch1:V₀₁,ch2:V₀₂)

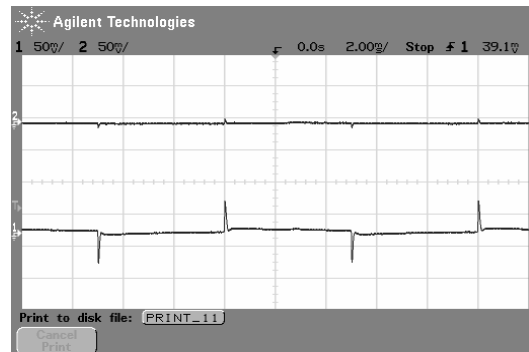

ALQ07FY 50%-75%-50% $I_{o1,nom}$ (I_{o1})
load change, $I_{o2} = 50\%I_{o2,nom}$ (ch1:V₀₁,ch2:V₀₂)

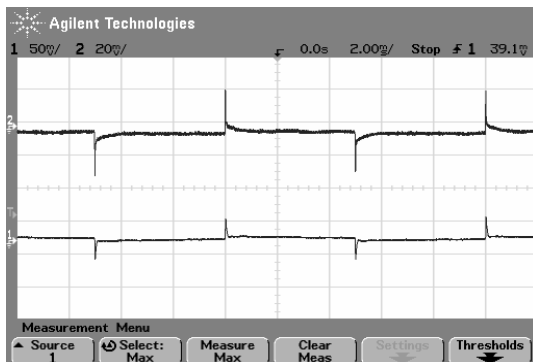

ALQ07FY 25%-50%-25% $I_{o2,nom}$ (I_{o2})
load change, $I_{o1} = 50\%I_{o1,nom}$ (ch1:V₀₁,ch2:V₀₂)

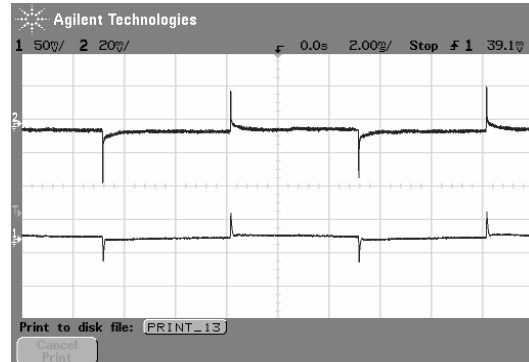

ALQ07FY 50%-75%-50% $I_{o2,nom}$ (I_{o2})
load change, $I_{o1} = 50\%I_{o1,nom}$ (ch1:V₀₁,ch2:V₀₂)

Performance Curves – Transient Response (Cont.)

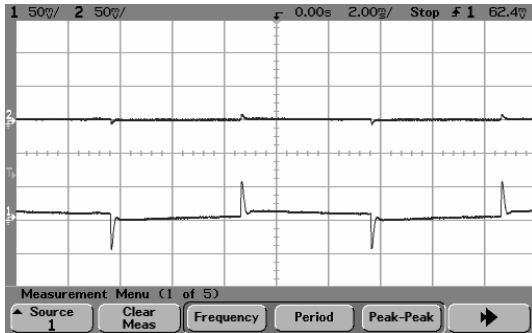

ALQ07FM 25%-50%-25% $I_{o1,nom}$ (I_{o1})
load change, $I_{o2} = 50\%I_{o2,nom}$ (ch1: V_{o1} ,ch2: V_{o2})



ALQ07FM 50%-75%-50% $I_{o1,nom}$ (I_{o1})
load change, $I_{o2} = 50\%I_{o2,nom}$ (ch1: V_{o1} ,ch2: V_{o2})



ALQ07FM 25%-50%-25% $I_{o2,nom}$ (I_{o2})
load change, $I_{o1} = 50\%I_{o1,nom}$ (ch1: V_{o1} ,ch2: V_{o2})

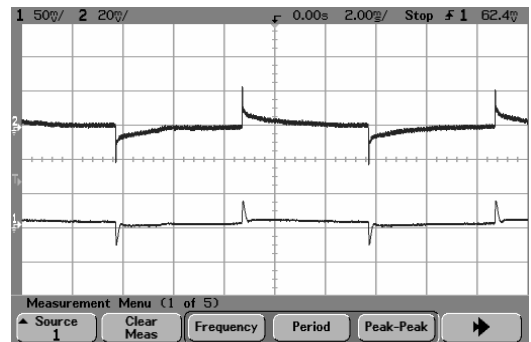

ALQ07FM 50%-75%-50% $I_{o2,nom}$ (I_{o2})
load change, $I_{o1} = 50\%I_{o1,nom}$ (ch1: V_{o1} ,ch2: V_{o2})

Performance Curves – Transient Response (Cont.)

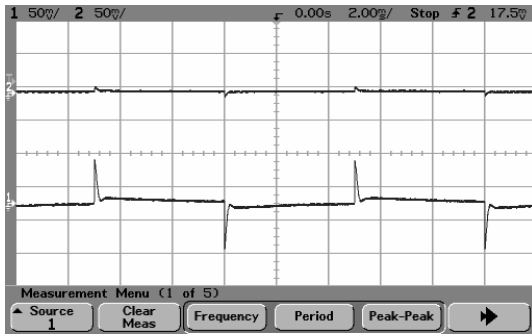

ALQ07FK 25%-50%-25% $I_{o1,nom}$ (I_{o1})
load change, $I_{o2} = 50\%I_{o2,nom}$ (ch1: V_{o1} ,ch2: V_{o2})

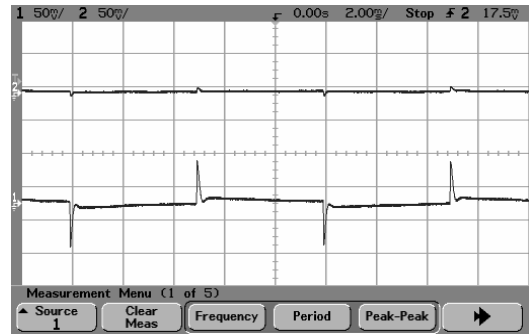

ALQ07FK 50%-75%-50% $I_{o1,nom}$ (I_{o1})
load change, $I_{o2} = 50\%I_{o2,nom}$ (ch1: V_{o1} ,ch2: V_{o2})

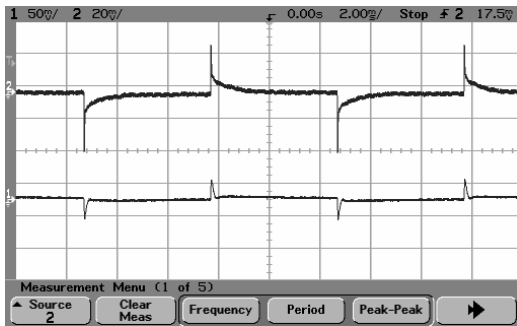

ALQ07FK 25%-50%-25% $I_{o2,nom}$ (I_{o2})
load change, $I_{o1} = 50\%I_{o1,nom}$ (ch1: V_{o1} ,ch2: V_{o2})

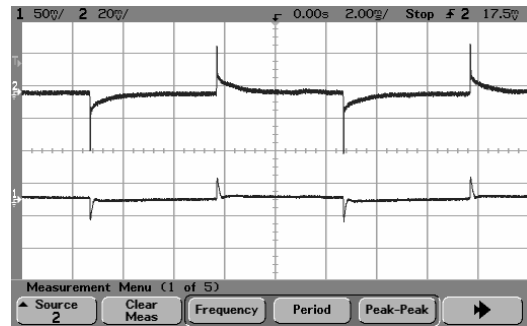

ALQ07FK 50%-75%-50% $I_{o2,nom}$ (I_{o2})
load change, $I_{o1} = 50\%I_{o1,nom}$ (ch1: V_{o1} ,ch2: V_{o2})

Performance Curves – Startup Characteristics

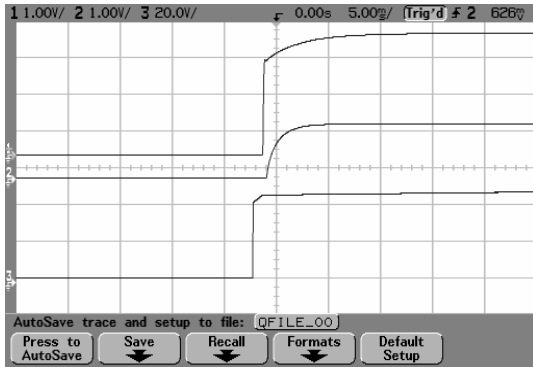

ALQ07FY Start-up from Power On

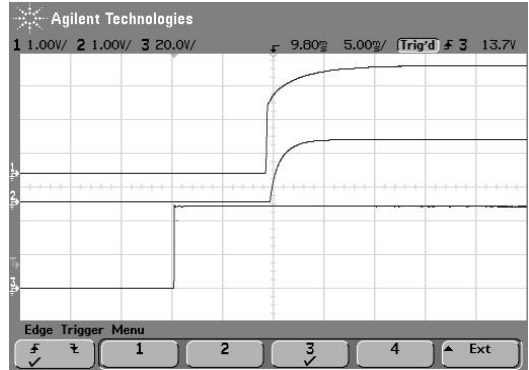

ALQ07FM Start-up from Power On

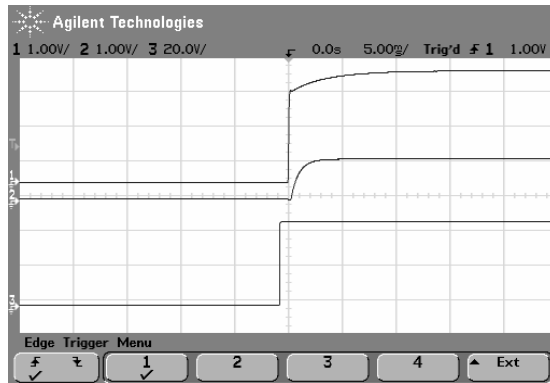

ALQ07FK Start-up from Power On

Performance Curves – Startup from CNT Control



ALQ07FY Start-up from CNT On

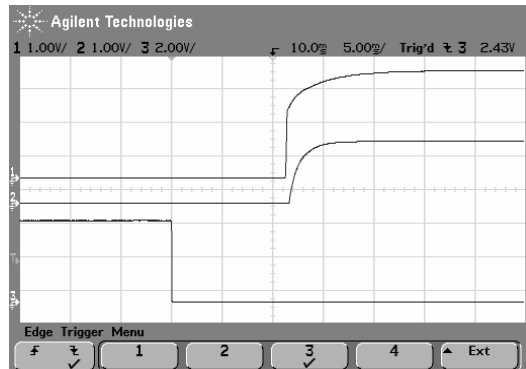

ALQ07FM Start-up from CNT On

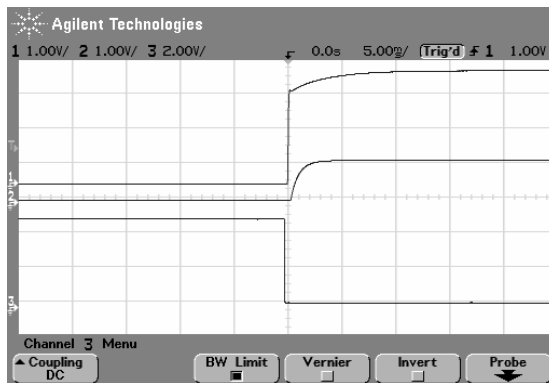

ALQ07FK Start-up from CNT On

Feature Description

CNT Function

Two CNT logic options are available. The CNT logic, CNT voltage and the module working state are as the following Table 1.

	L	H	OPEN
N	ON	OFF	OFF
P	OFF	ON	ON

Table 1

N--- means "Negative Logic", P--- means "Positive Logic"

L--- means "Low Logic Voltage", $-0.7V \leq L \leq 1.8V$

H--- means "High Logic Voltage", $3.5V \leq H \leq 12V$

ON--- means "Module is on", OFF--- means "Module is off"

Open--- means "CNT pin is left open"

 **Note:**

Normally, $V_{CNT} \leq 12V$, but when CNT is left open, V_{CNT} may reach to 15V.

The following Figure shows a few simple CNT circuits.

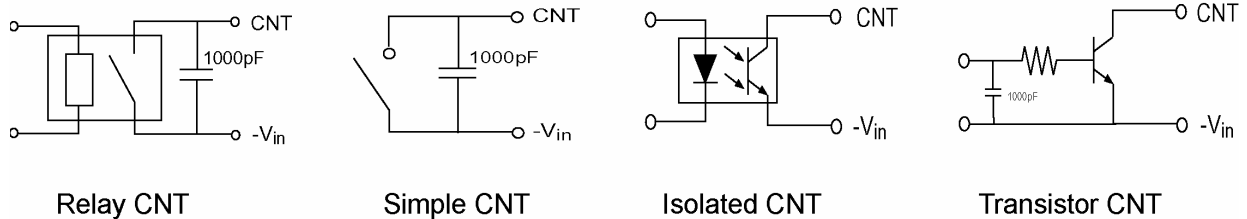

Trim

The +Vo2 output voltage of the ALQ07 series can be trimmed using the trim pin provided. Applying a resistor R_{trim} between the trim pin and either the COM or +Vo2 pin will cause the +Vo2 output to increase by up to 10% or decrease by down to 20%. Trimming up by more than 10% of the nominal output may activate the OVP circuit or damage the converter. Trimming down more than 20% can cause the converter to regulate improperly. If the trim pin is not needed, it should be left open.

Trim up

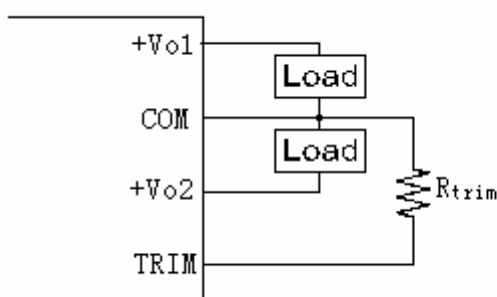

$$\begin{aligned} +V_{o2}=1.8V: & R_{trim}=848.45/(0.947V_o-1.709) \\ +V_{o2}=1.5V: & R_{trim}=586.95/(0.957V_o-1.435) \\ +V_{o2}=1.2V: & R_{trim}=293.2/(0.925V_o-1.112) \end{aligned}$$

The resistor value is in Ohm.
Vo is the output voltage after trim-up

Trim down

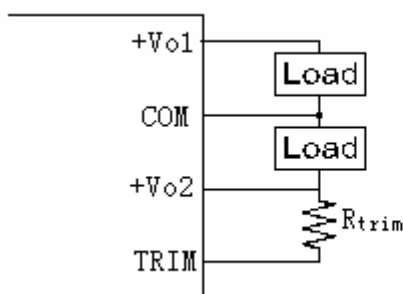

$$\begin{aligned} +V_{o2}=1.8V: & R_{trim}=(848.48-987.72V_o)/(0.947V_o-1.709) \\ +V_{o2}=1.5V: & R_{trim}=(586.98-683.3V_o)/(0.957V_o-1.435) \\ +V_{o2}=1.2V: & R_{trim}=(293.21-341.33V_o)/(0.925V_o-1.112) \end{aligned}$$

The resistor is in Ohm.
Vo is the output voltage after trim-down.

Minimum Load Requirements

Parameter	Device	Symbol	Typ	Unit
Minimum Load	All	Io1MIN	0	A
		Io2MIN	0	A

Output Over-current Protection

For ALQ07 series DC/DC converters, when any output occurs over-current, all outputs shut down after 100-300ms. The module can be restarted by resetting the input power or CNT control.

Output Over-voltage Protection

The over-voltage protection has a separate feedback loop, which is activated when the output voltage exceeds 120% to 150% of the nominal output voltage. The module can be restarted by resetting the input power or CNT control.

Over Temperature Protection

ALQ07 DC/DC converters will shut down when the temperature of the board reaches 101°C to 115°C, and the module will automatically restart if the temperature of the board is under 100°C.

Output Filters

When the load is sensitive to ripple and noise, an output filter can be added to minimize the effects. A simple output filter to reduce output ripple and noise can be made by connecting a capacitor C_{out} across the output as shown in Figure 'Output Ripple Filter'. The recommended value for the output tantalum capacitor C_{out} is 220uF.

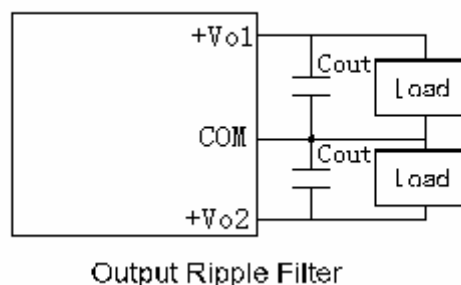

Extra care should be taken when long leads or traces are used to provide power to the load. Long lead lengths increase the chance for noise to appear on the lines. Under these conditions C1 can be added across the load, with a 0.1uF ceramic capacitor C1 in parallel generally as shown in Figure 'Output Ripple Filter for a Distant Load'.

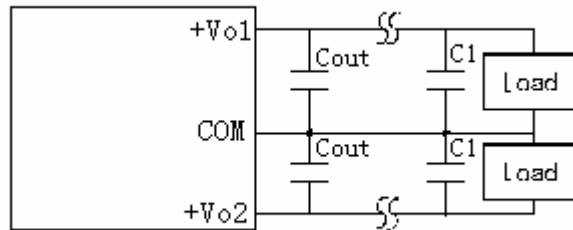

Output Ripple Filter For a Distant Load

Decoupling

Noise on the power distribution system is not always created by the converter. High speed analog or digital loads with dynamic power demands can cause noise to cross the power inductor back onto the input lines. Noise can be reduced by decoupling the load. In most cases, connecting a 10uF tantalum or ceramic capacitor in parallel with a 0.1uF ceramic capacitor across the load will decouple it. The capacitors should be connected as close to the load as possible.

Ground Loops

Ground loops occur when different circuits are given multiple paths to common or earth ground, as shown in Figure 'Ground Loops'. Multiple ground points can be slightly different potential and cause current flow through the circuit from one point to another. This can result in additional noise in all the circuits. To eliminate the problem, circuits should be designed with a single ground connection as shown in Figure 'Single Point Ground'.

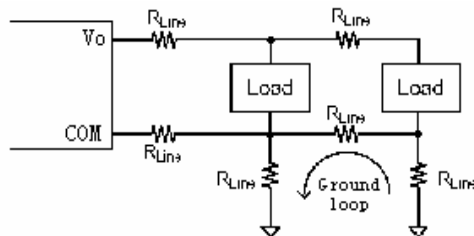

Ground Loops

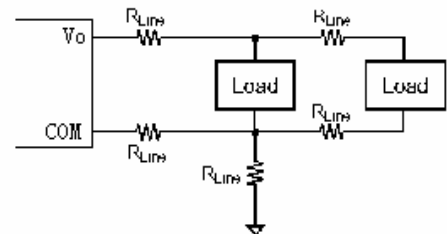

Single Point Ground

Design Consideration

Typical Application

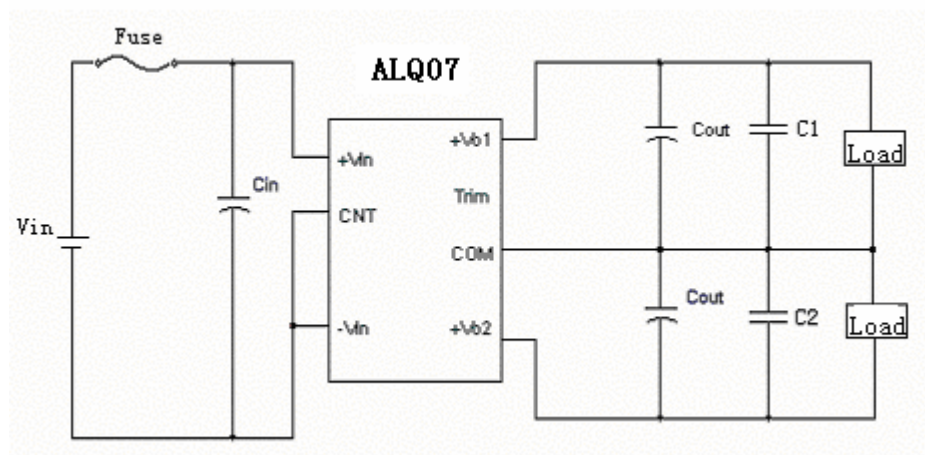

Cin: Recommended input capacitor 47uF, aluminum electrolytic type

Cout: Recommended output capacitor 220uF, Tantalum type, each capacitor ESR<100mΩ

C1,C2: Recommended 0.1uF ceramic capacitor

 **Note:**

$$I_{o1} + I_{o2} \leq 10A$$

Fusing

The ALQ07 power modules have no internal fuse. An external fuse must always be employed! To meet international safety requirements, a 250 Volt rated fuse should be used. If one of the input lines is connected to chassis ground, then the fuse must be placed in the other input line.

Standard safety agency regulations require input fusing. Recommended fuse rating for the ALQ07 Series is 2A.

Input Reverse Voltage Protection

Under installation and cabling conditions where reverse polarity across the input may occur, reverse polarity protection is recommended. Protection can easily be provided as shown in Figure 'Reverse Polarity Protection Circuit'. In both cases the diode used is rated for 3A/100V. Placing the diode across the inputs rather than in-line with the input offers an advantage in that the diode only conducts in a reverse polarity condition, this increases circuit efficiency and thermal performance.

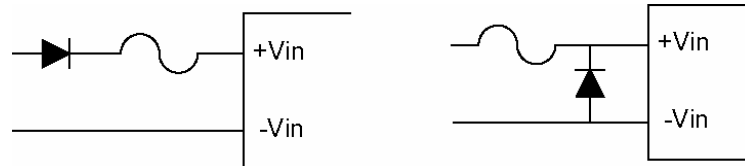

Reverse Polarity Protection Circuit

EMC

Input filters are included in the converters to help achieve standard system emissions certifications. Some users however, may find that additional input filtering is necessary. The ALQ07 series has an internal switching frequency of 360kHz so a high frequency capacitor mounted close to the input terminals produces the best results. To reduce reflected noise, a capacitor can be added across the input as shown in Figure 'Ripple Rejection Input Filter', forming a filter. A 47 μ F/100V electrolytic capacitor is recommended for C_{in} .

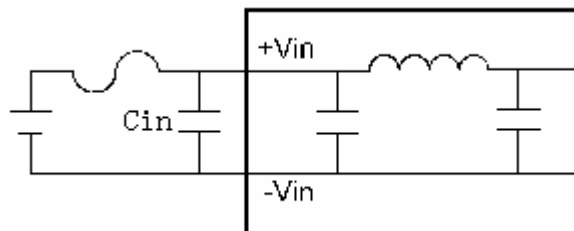

Ripple Rejection Input Filter

For conditions where EMI is a concern, a different input filter can be used. The following figure 'EMI Reduction Filter' shows a filter designed to reduce EMI effects. ALQ07 series can meet EN55022 CLASS A with the following figure.

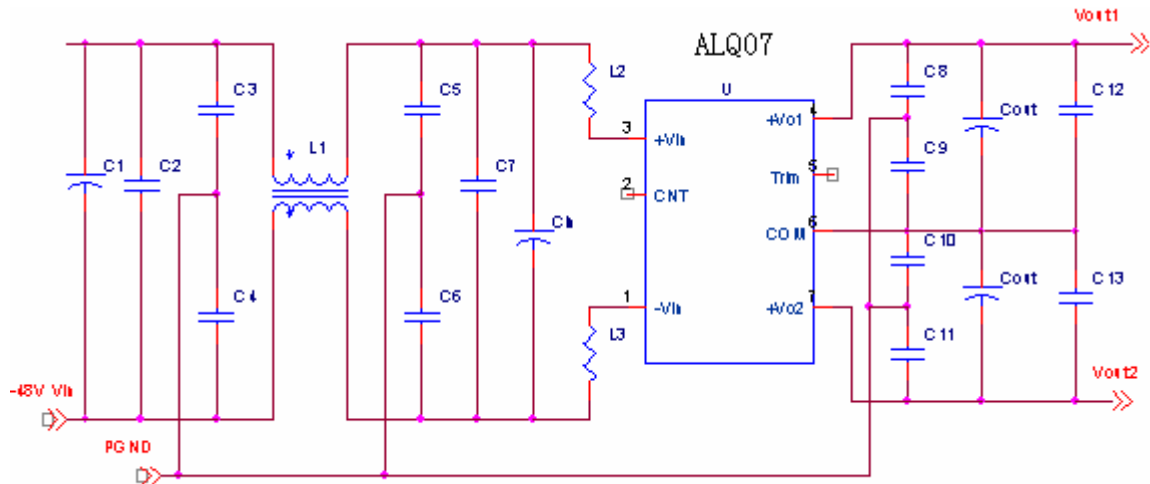

The recommended values can refer to the following table:

Component	Value/Rating	Type	Description	Price
C1	None	None	None	—
C2	2.2uF/250Vac	Metal film capacitor	—	—
C3, C4, C8, C9, C10, C11	4700pF/250Vac	Safety Y capacitor	—	—
C5, C6	0.022uF/275Vac	Safety Y capacitor	—	—
C7	1000pF/100V	Ceramic	—	—
C12, C13	0.1uF/50V	Ceramic	—	—
Cin	47uF/100V	Aluminum Electrolytic	Aluminum Electrolytic — 100V—47uF±20% — 10*12.5— 105°C	—
Cout	220uF/10V	Tantalum	Each capacitor ESR<100mΩ	—
L1	2.7mH	Common mode	Ferrite coreφ16 8/8, ferrite	—
L2, L3	--	Ferrite Bead	Ferrite, 1206 package, 3A/50Ω	—

Safety Consideration

For safety-agency approval of the system in which the power module is used, the power module must be installed in compliance with the spacing and separation requirements of the end-use safety agency standard, i.e., UL1950, CSA C22.2 No. 950-95, and EN60950. The ALQ07 series input-to-output isolation is a basic insulation. The DC/DC power module should be installed in end-use equipment, in compliance with the requirements of the ultimate application, and is intended to be supplied by an isolated secondary circuit. When the supply to the DC/DC power module meets all the requirements for SELV(<60Vdc), the output is considered to remain within SELV limits (level 3). If connected to a 60Vdc power system, double or reinforced insulation must be provided in the power supply that isolates the input from any hazardous voltages, including the ac mains. One input pin and one output pin are to be grounded or both the input and output pins are to be kept floating. Single fault testing in the power supply must be performed in combination with the DC/DC power module to demonstrate that the output meets the requirement for SELV. The input pins of the module are not operator accessible.

Note: Do not ground either of the input pins of the module, without grounding one of the output pins. This may allow a non-SELV voltage to appear between the output pin and ground.

Thermal Consideration

When 48V input, 60°C ambient temperature, and 150LFM airflow, ALQ07 series are rated for full power, and in this condition the case temperature can reach 90°C. For operation above ambient temperature of 60°C, output power must be derated as shown in Figure 'Temperature Derating', meantime, airflow at least 150LFM over the converter must be provided to make the module working properly. The case temperature should be used to determine maximum temperature limits. The minimum operating temperature for the ALQ07 is -40°C.

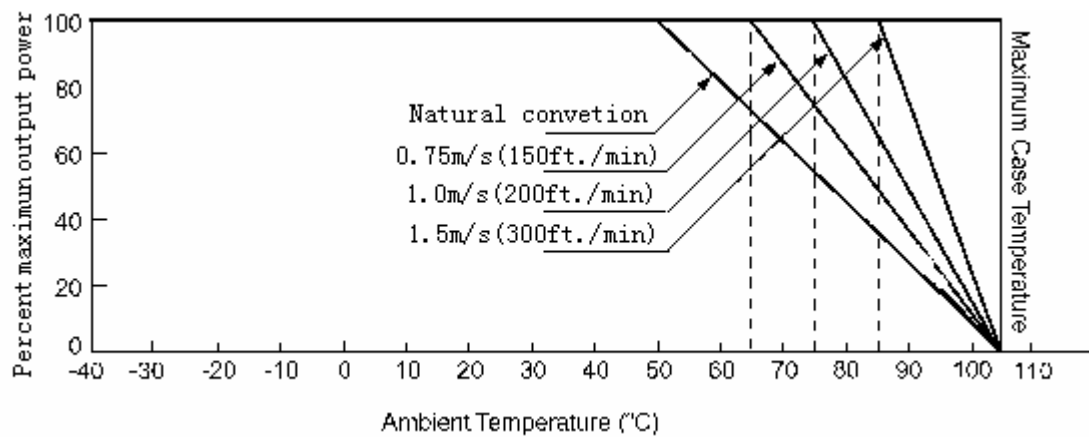

Temperature Derating Curves

MTBF

The MTBF, calculated in accordance with Bellcore TR-NWT-000332 is 1,800,000 hours. Obtaining this MTBF in practice is entirely possible. If the ambient air temperature is expected to exceed +25°C, then we also advise an oriented for the best possible cooling in the air stream.

ASTEC can supply replacements for converters from other manufacturers, or offer custom solutions. Please contact the factory for details.

Mechanical Considerations

Installation

Although ALQ07 series converters can be mounted in any orientation, free air-flowing must be taken. Normally power components are always put at the end of the airflow path or have the separate airflow paths. This can keep other system equipment cooler and increase component life spans.

Soldering

ALQ07 series converters are compatible with standard wave soldering techniques. When wave soldering, the converter pins should be preheated for 20-30 seconds at 110°C, and wave soldered at 260°C for less than 10 seconds.

When hand soldering, the iron temperature should be maintained at 425°C and applied to the converter pins for less than 5 seconds. Longer exposure can cause internal damage to the converter. Cleaning can be performed with cleaning solvent IPA or with water.

Mechanical Chart (pin side view)

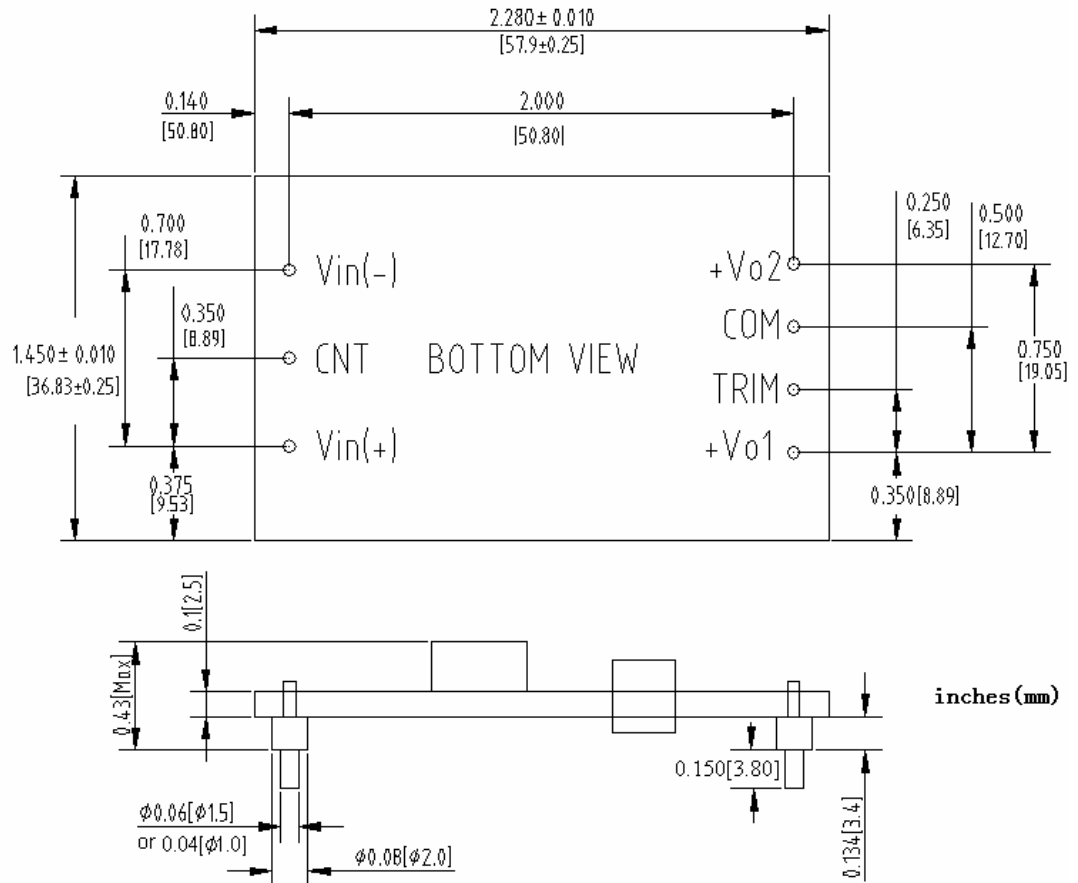

Note: Pin length is optional

Default: $5.8\text{mm} \pm 0.5\text{mm}$ ($0.228\text{in.} \pm 0.02\text{in.}$)

Product name with suffix "-4": $4.8\text{mm} \pm 0.5\text{mm}$ ($0.189\text{in.} \pm 0.02\text{in.}$)

Product name with suffix "-6": $3.8\text{mm} \pm 0.25\text{mm}$ ($0.15\text{in.} \pm 0.01\text{in.}$)

Product name with suffix "-8": $2.8\text{mm} \pm 0.25\text{mm}$ ($0.11\text{in.} \pm 0.01\text{in.}$)

Ordering Information

Model Number	Input Voltage (V)	Output Voltage (V)		Output Current * (A)	Ripple (mV ms) max.	Noise (mV pp) max.	Efficiency % typ.
ALQ07FY	36-75	Vo1	3.3	6	50	50	81
		Vo2	1.8	4	50	50	
ALQ07FM	36-75	Vo1	3.3	6	50	50	81
		Vo2	1.5	4	50	50	
ALQ07FK	36-75	Vo1	3.3	6	50	50	81
		Vo2	1.2	4	50	50	

 **Note:**

Io1: 0A~6A, Io2: 0A~7A, Io1+Io2 ≤ 10A.