

## Silicon PIN Photodiode, RoHS Compliant, Released for Lead (Pb)-free Solder Process, AEC-Q101 Released

### Description

TEMD5120X01 is a high speed and high sensitive PIN photodiode. It is a miniature Surface Mount Device (SMD) including the chip with a 4.4 mm<sup>2</sup> sensitive area and an infrared bandpass filter matched to IR Emitters operating at wavelength 870 nm or 950 nm.

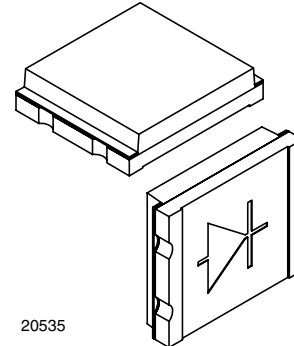

### Features

- Product designed and qualified acc. AEC-Q101 for the automotive market
- Radiant sensitive area:  $A = 4.4 \text{ mm}^2$
- Wide angle of half sensitivity  $\varphi = \pm 65^\circ$
- High photo sensitivity
- Fast response times
- Small junction capacitance
- Plastic package with IR filter:  $\lambda = 870\text{...}950 \text{ nm}$
- Floor life: 72 h, MSL 4, acc. J-STD-20
- Lead (Pb)-free component
- Component in accordance to ELV 2000/53/EC, RoHS 2002/95/EC and WEEE 2002/96/EC



### Applications

- Automotive sensors
- Infrared detectors
- High speed photo detectors

### Absolute Maximum Ratings

$T_{\text{amb}} = 25 \text{ }^\circ\text{C}$ , unless otherwise specified

| Parameter                           | Test condition                                  | Symbol            | Value         | Unit             |
|-------------------------------------|---|-------------------|---------------|------------------|
| Reverse voltage                     |   | $V_R$             | 60            | V                |
| Power dissipation                   | $T_{\text{amb}} \leq 25 \text{ }^\circ\text{C}$ | $P_V$             | 215           | mW               |
| Junction temperature                |   | $T_j$             | 100           | $^\circ\text{C}$ |
| Operating temperature range         |   | $T_{\text{amb}}$  | - 40 to + 100 | $^\circ\text{C}$ |
| Storage temperature range           |   | $T_{\text{stg}}$  | - 40 to + 100 | $^\circ\text{C}$ |
| Soldering temperature               | In accordance with fig. 8                       | $T_{\text{sd}}$   | 260           | $^\circ\text{C}$ |
| Thermal resistance junction/ambient |   | $R_{\text{thJA}}$ | 350           | K/W              |

### Electrical Characteristics

$T_{amb} = 25\text{ }^{\circ}\text{C}$ , unless otherwise specified

| Parameter            | Test condition                                    | Symbol     | Min | Typ. | Max | Unit |
|----------------------|---|------------|-----|------|-----|------|
| Forward voltage      | $I_F = 50\text{ mA}$                              | $V_F$      |     | 1    | 1.3 | V    |
| Breakdown voltage    | $I_R = 100\text{ }\mu\text{A}$ , $E = 0$          | $V_{(BR)}$ | 60  |      |     | V    |
| Reverse dark current | $V_R = 10\text{ V}$ , $E = 0$                     | $I_{ro}$   |     | 2    | 30  | nA   |
| Diode capacitance    | $V_R = 0\text{ V}$ , $f = 1\text{ MHz}$ , $E = 0$ | $C_D$      |     | 48   |     | pF   |

### Optical Characteristics

$T_{amb} = 25\text{ }^{\circ}\text{C}$ , unless otherwise specified

| Parameter                        | Test condition   | Symbol          | Min | Typ.                | Max | Unit                        |
|----------------------------------|--|-----------------|-----|---------------------|-----|-----------------------------|
| Open circuit voltage             | $E_e = 1\text{ mW/cm}^2$ , $\lambda = 950\text{ nm}$                         | $V_o$           |     | 350                 |     | mV                          |
| Temperature coefficient of $V_o$ | $E_e = 1\text{ mW/cm}^2$ , $\lambda = 950\text{ nm}$                         | $TK_{V_o}$      |     | -2.6                |     | mV/K                        |
| Short circuit current            | $E_e = 1\text{ mW/cm}^2$ , $\lambda = 950\text{ nm}$                         | $I_k$           |     | 32                  |     | $\mu\text{A}$               |
| Temperature coefficient of $I_k$ | $E_e = 1\text{ mW/cm}^2$ , $\lambda = 950\text{ nm}$                         | $TK_{I_k}$      |     | 0.1                 |     | %/K                         |
| Reverse light current            | $E_e = 1\text{ mW/cm}^2$ , $\lambda = 950\text{ nm}$ ,<br>$V_R = 5\text{ V}$ | $I_{ra}$        | 25  | 35                  |     | $\mu\text{A}$               |
| Angle of half sensitivity        |  | $\phi$          |     | $\pm 65$            |     | deg                         |
| Wavelength of peak sensitivity   |  | $\lambda_p$     |     | 940                 |     | nm                          |
| Range of spectral bandwidth      |  | $\lambda_{0.5}$ |     | 790 to 1050         |     | nm                          |
| Noise equivalent power           | $V_R = 10\text{ V}$ , $\lambda = 950\text{ nm}$                              | NEP             |     | $4 \times 10^{-14}$ |     | $\text{W}/\sqrt{\text{Hz}}$ |
| Rise time                        | $V_R = 10\text{ V}$ , $R_L = 1\text{ k}\Omega$ , $\lambda = 820\text{ nm}$   | $t_r$           |     | 100                 |     | ns                          |
| Fall time                        | $V_R = 10\text{ V}$ , $R_L = 1\text{ k}\Omega$ , $\lambda = 820\text{ nm}$   | $t_f$           |     | 100                 |     | ns                          |

### Typical Characteristics

$T_{amb} = 25\text{ }^{\circ}\text{C}$ , unless otherwise specified

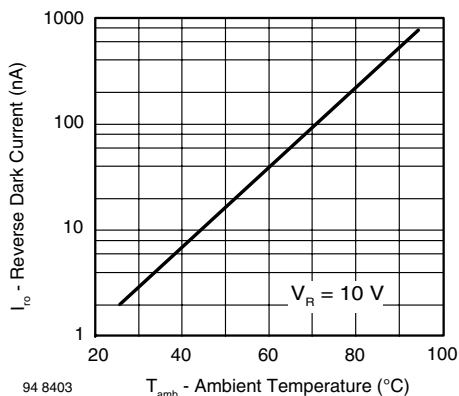

Figure 1. Reverse Dark Current vs. Ambient Temperature

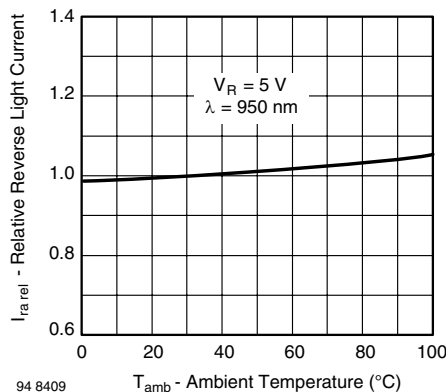
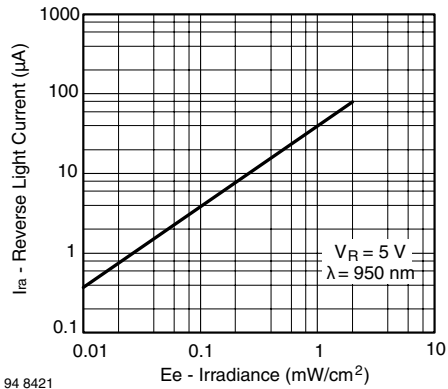
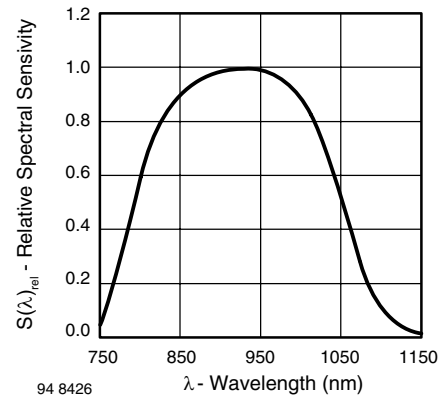

Figure 2. Relative Reverse Light Current vs. Ambient Temperature



94 8421

Figure 3. Reverse Light Current vs. Irradiance



94 8426

Figure 6. Relative Spectral Sensitivity vs. Wavelength

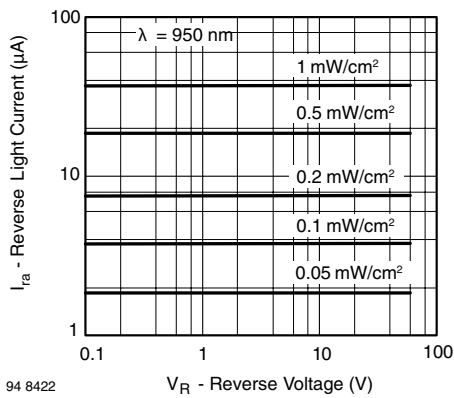

94 8422

Figure 4. Reverse Light Current vs. Reverse Voltage

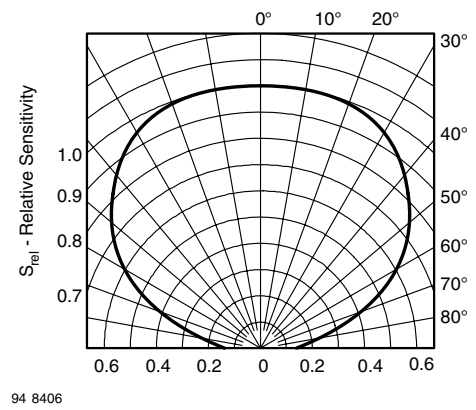

94 8406

Figure 7. Relative Radiant Sensitivity vs. Angular Displacement

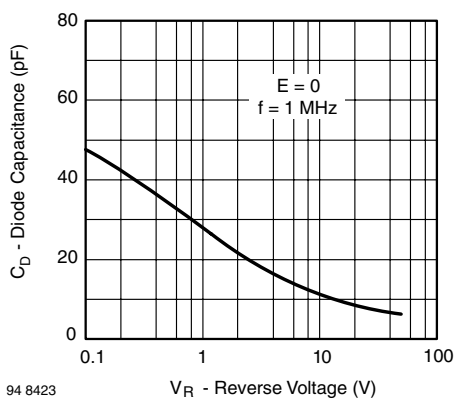

94 8423

Figure 5. Diode Capacitance vs. Reverse Voltage

# TEMD5120X01

Vishay Semiconductors



## Package Dimensions in millimeters

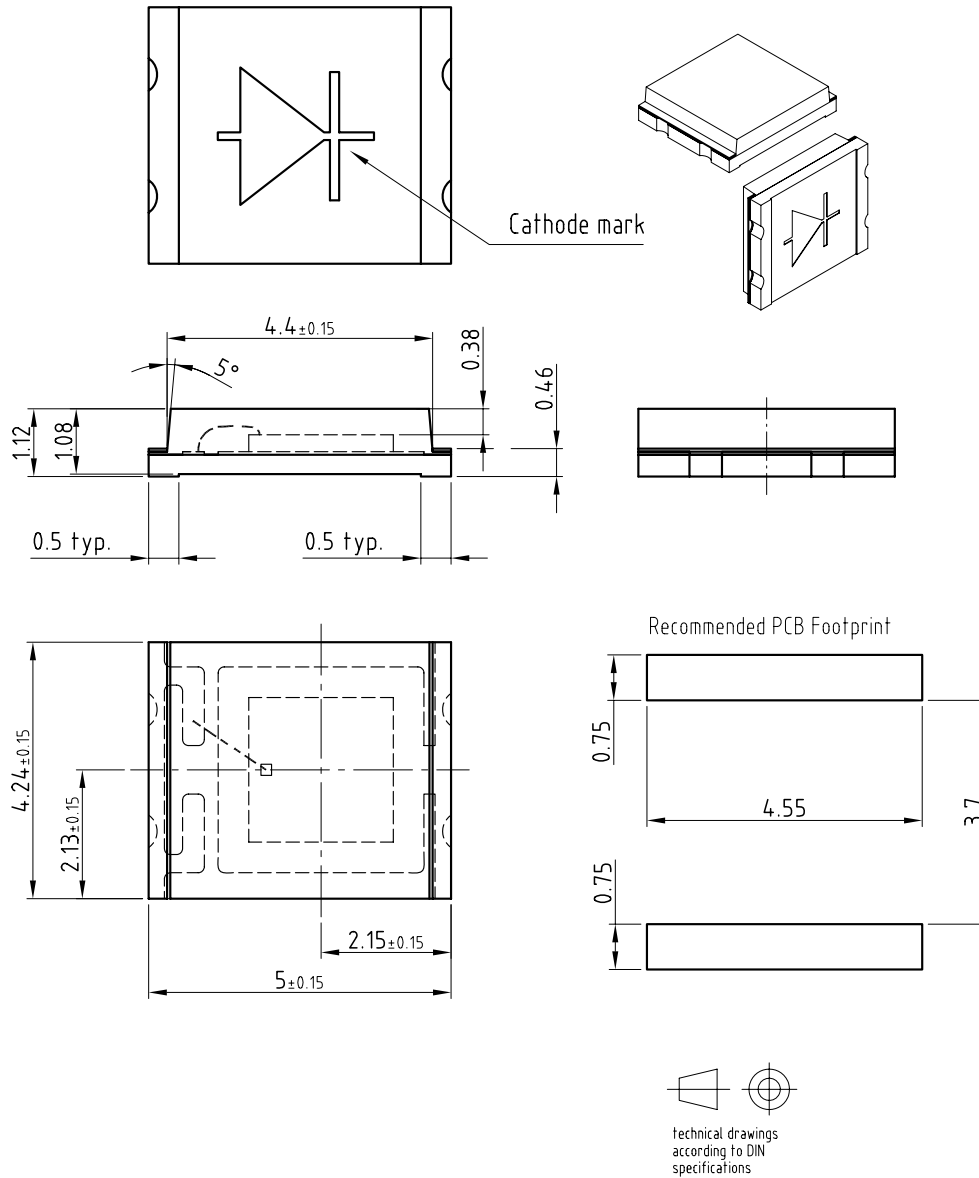

Drawing-No.: 6.541-5059.01-4  
Issue: 4; 26.04.07  
19280

Not indicated tolerances  $\pm 0.1$

Minimum order quantity (MOQ): 1500 pcs (1 reel)



## Reflow Solder Profiles

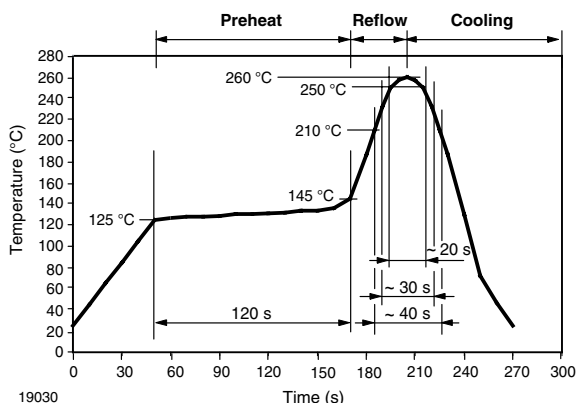

Figure 8. Lead (Pb)-free (Sn) Reflow Solder Profile

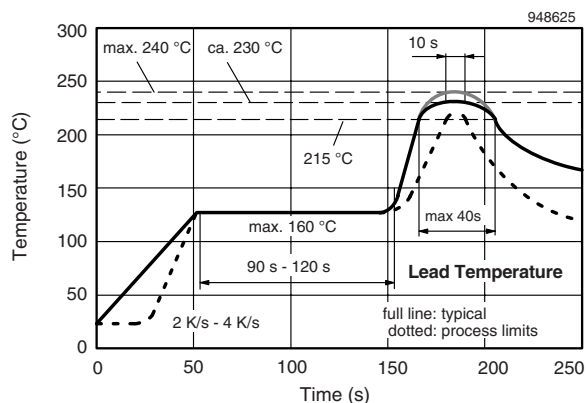

Figure 9. Lead Tin (SnPb) Reflow Solder Profile

## Drypack

Devices are packed in moisture barrier bags (MBB) to prevent the products from moisture absorption during transportation and storage. Each bag contains a desiccant.

## Floor Life

Floor life (time between soldering and removing from MBB) must not exceed the time indicated in J-STD-020. TEMD5110 is released for: Moisture Sensitivity Level 4, according to JEDEC, J-STD-020  
 Floor Life: 72 h  
 Conditions:  $T_{amb} < 30\text{ }^{\circ}\text{C}$ ,  $\text{RH} < 60\%$

## Drying

In case of moisture absorption devices should be baked before soldering. Conditions see J-STD-020 or Label. Devices taped on reel dry using recommended conditions 192 h at  $40\text{ }^{\circ}\text{C}$  (+  $5\text{ }^{\circ}\text{C}$ ),  $\text{RH} < 5\%$  or 96 h at  $60\text{ }^{\circ}\text{C}$  (+  $5\text{ }^{\circ}\text{C}$ ),  $\text{RH} < 5\%$ .

**Ozone Depleting Substances Policy Statement**

It is the policy of Vishay Semiconductor GmbH to

1. Meet all present and future national and international statutory requirements.
2. Regularly and continuously improve the performance of our products, processes, distribution and operating systems with respect to their impact on the health and safety of our employees and the public, as well as their impact on the environment.

It is particular concern to control or eliminate releases of those substances into the atmosphere which are known as ozone depleting substances (ODSs).

The Montreal Protocol (1987) and its London Amendments (1990) intend to severely restrict the use of ODSs and forbid their use within the next ten years. Various national and international initiatives are pressing for an earlier ban on these substances.

Vishay Semiconductor GmbH has been able to use its policy of continuous improvements to eliminate the use of ODSs listed in the following documents.

1. Annex A, B and list of transitional substances of the Montreal Protocol and the London Amendments respectively
2. Class I and II ozone depleting substances in the Clean Air Act Amendments of 1990 by the Environmental Protection Agency (EPA) in the USA
3. Council Decision 88/540/EEC and 91/690/EEC Annex A, B and C (transitional substances) respectively.

Vishay Semiconductor GmbH can certify that our semiconductors are not manufactured with ozone depleting substances and do not contain such substances.

We reserve the right to make changes to improve technical design  
and may do so without further notice.

Parameters can vary in different applications. All operating parameters must be validated for each customer application by the customer. Should the buyer use Vishay Semiconductors products for any unintended or unauthorized application, the buyer shall indemnify Vishay Semiconductors against all claims, costs, damages, and expenses, arising out of, directly or indirectly, any claim of personal damage, injury or death associated with such unintended or unauthorized use.

Vishay Semiconductor GmbH, P.O.B. 3535, D-74025 Heilbronn, Germany



### Notice

Specifications of the products displayed herein are subject to change without notice. Vishay Intertechnology, Inc., or anyone on its behalf, assumes no responsibility or liability for any errors or inaccuracies.

Information contained herein is intended to provide a product description only. No license, express or implied, by estoppel or otherwise, to any intellectual property rights is granted by this document. Except as provided in Vishay's terms and conditions of sale for such products, Vishay assumes no liability whatsoever, and disclaims any express or implied warranty, relating to sale and/or use of Vishay products including liability or warranties relating to fitness for a particular purpose, merchantability, or infringement of any patent, copyright, or other intellectual property right.

The products shown herein are not designed for use in medical, life-saving, or life-sustaining applications. Customers using or selling these products for use in such applications do so at their own risk and agree to fully indemnify Vishay for any damages resulting from such improper use or sale.