

ELECTROSTATIC SENSITIVE DEVICE
OBSERVE HANDLING PRECAUTIONS

Silicon RF Power Semiconductors

RD06HHF1

RoHS Compliance, Silicon MOSFET Power Transistor 30MHz,6W

DESCRIPTION

RD06HHF1 is a MOS FET type transistor specifically designed for HF RF power amplifiers applications.

FEATURES

High power gain:
Pout>6W, Gp>16dB @Vdd=12.5V,f=30MHz

APPLICATION

For output stage of high power amplifiers in HF band mobile radio sets.

RoHS COMPLIANT

RD06HHF1-101 is a RoHS compliant products.
RoHS compliance is indicate by the letter "G" after the lot marking.

This product include the lead in high melting temperature type solders.
How ever,it applicable to the following exceptions of RoHS Directions.

- 1.Lead in high melting temperature type solders(i.e.tin-lead solder alloys containing more than85% lead.)

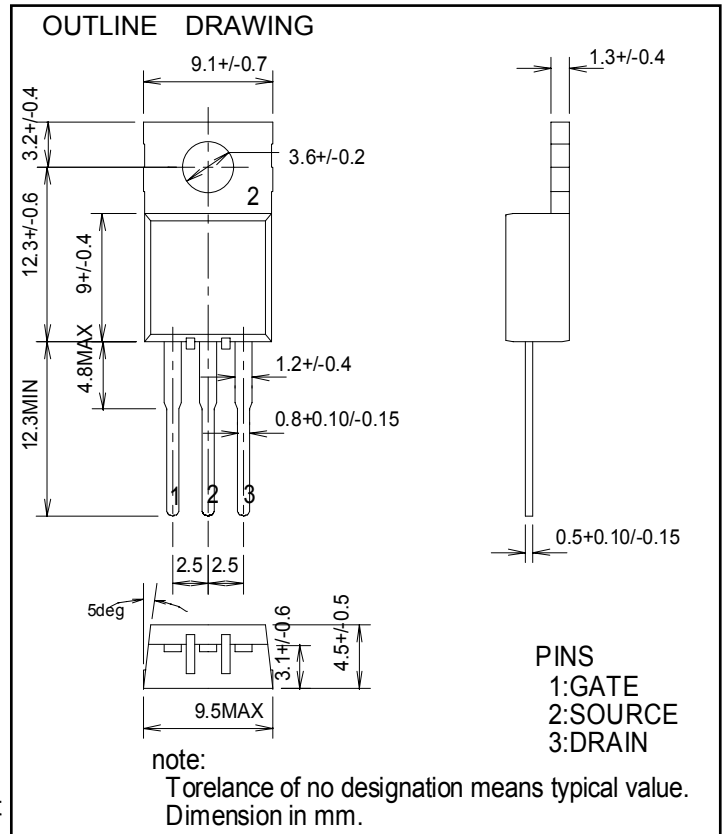

RD06HHF1

RoHS Compliance, Silicon MOSFET Power Transistor 30MHz,6W

ABSOLUTE MAXIMUM RATINGS

(Tc=25°C UNLESS OTHERWISE NOTED)

SYMBOL	PARAMETER	CONDITIONS	RATINGS	UNIT
V _{DSS}	Drain to source voltage	V _{gs} =0V	50	V
V _{GSS}	Gate to source voltage	V _{ds} =0V	+/- 20	V
P _{ch}	Channel dissipation	T _c =25°C	27.8	W
P _{in}	Input power	Z _g =Z _l =50Ω	0.3	W
I _D	Drain current	-	3	A
T _{ch}	Channel temperature	-	150	°C
T _{stg}	Storage temperature	-	-40 to +150	°C
R _{th j-c}	Thermal resistance	junction to case	4.5	°C/W

Note 1: Above parameters are guaranteed independently.

ELECTRICAL CHARACTERISTICS

(Tc=25°C, UNLESS OTHERWISE NOTED)

SYMBOL	PARAMETER	CONDITIONS	LIMITS			UNIT
			MIN	TYP	MAX.	
I _{DSS}	Drain cutoff current	V _{DS} =17V, V _{GS} =0V	-	-	10	μA
I _{GSS}	Gate cutoff current	V _{GS} =10V, V _{DS} =0V	-	-	1	μA
V _{TH}	Gate threshold Voltage	V _{DS} =12V, I _{DS} =1mA	1.9	-	4.9	V
P _{out}	Output power	V _{DD} =12.5V, P _{in} =0.15W,	6	10	-	W
η _D	Drain efficiency	f=30MHz, I _{dq} =0.5A	55	65	-	%
	Load VSWR tolerance	V _{DD} =15.2V, P _o =6W(Pin Control) f=30MHz, I _{dq} =0.5A, Z _g =50Ω Load VSWR=20:1(All Phase)	No destroy			-

Note : Above parameters , ratings , limits and conditions are subject to change.

TYPICAL CHARACTERISTICS

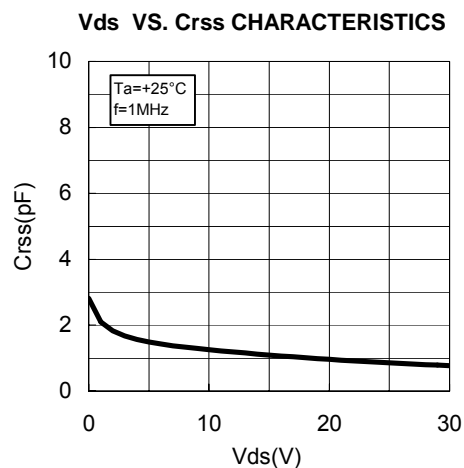
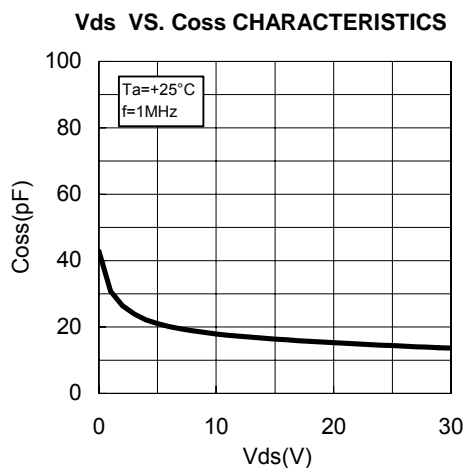
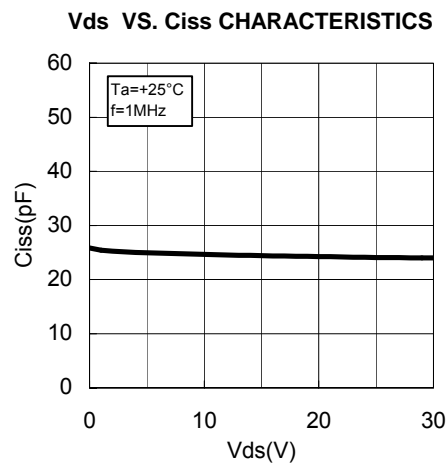
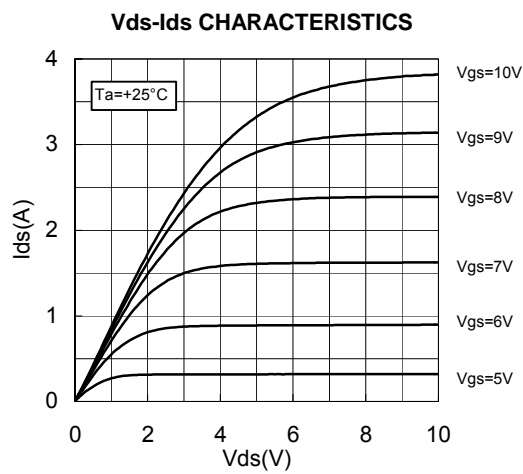
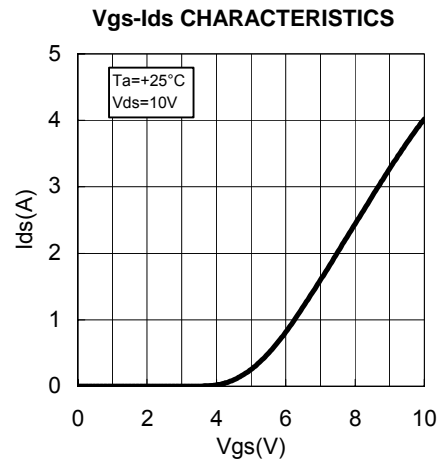
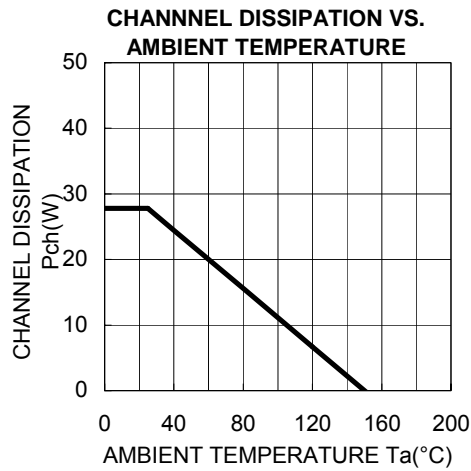

TYPICAL CHARACTERISTICS

Pin-Po CHARACTERISTICS

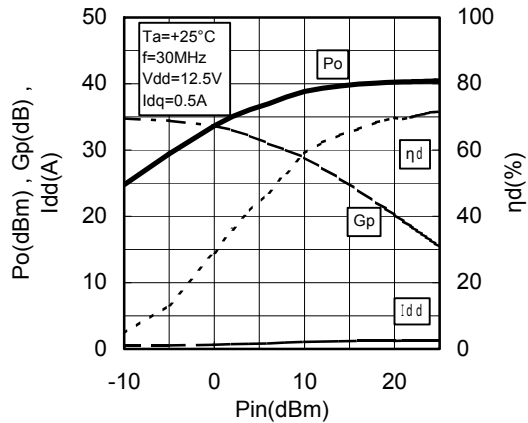

Pin-Po CHARACTERISTICS

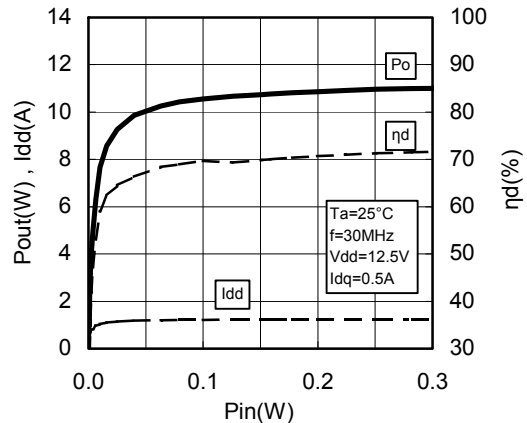

Vdd-Po CHARACTERISTICS

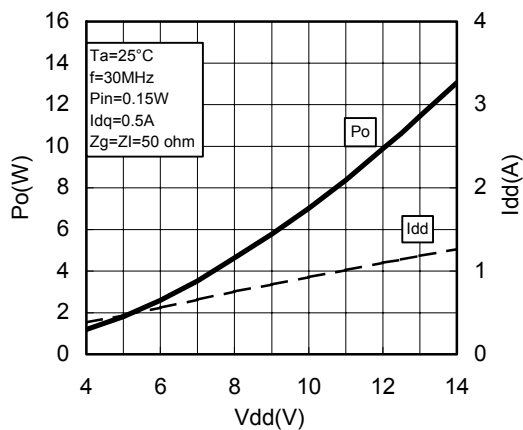

Vgs-Ids CHARACTERISTICS 2

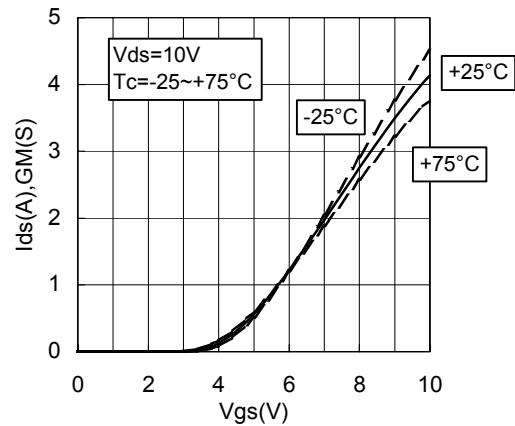

Vgs-gm CHARACTERISTICS

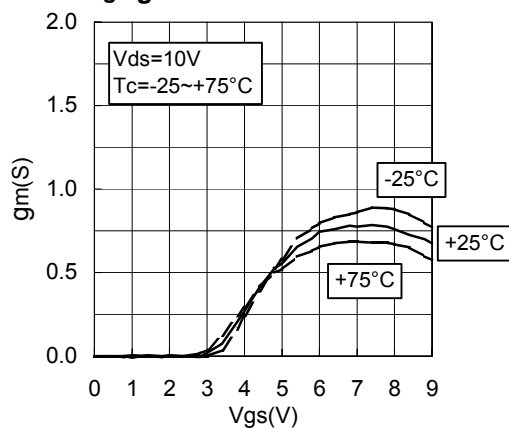

RD06HHF1

RoHS Compliance, Silicon MOSFET Power Transistor 30MHz,6W

TEST CIRCUIT(f=30MHz)

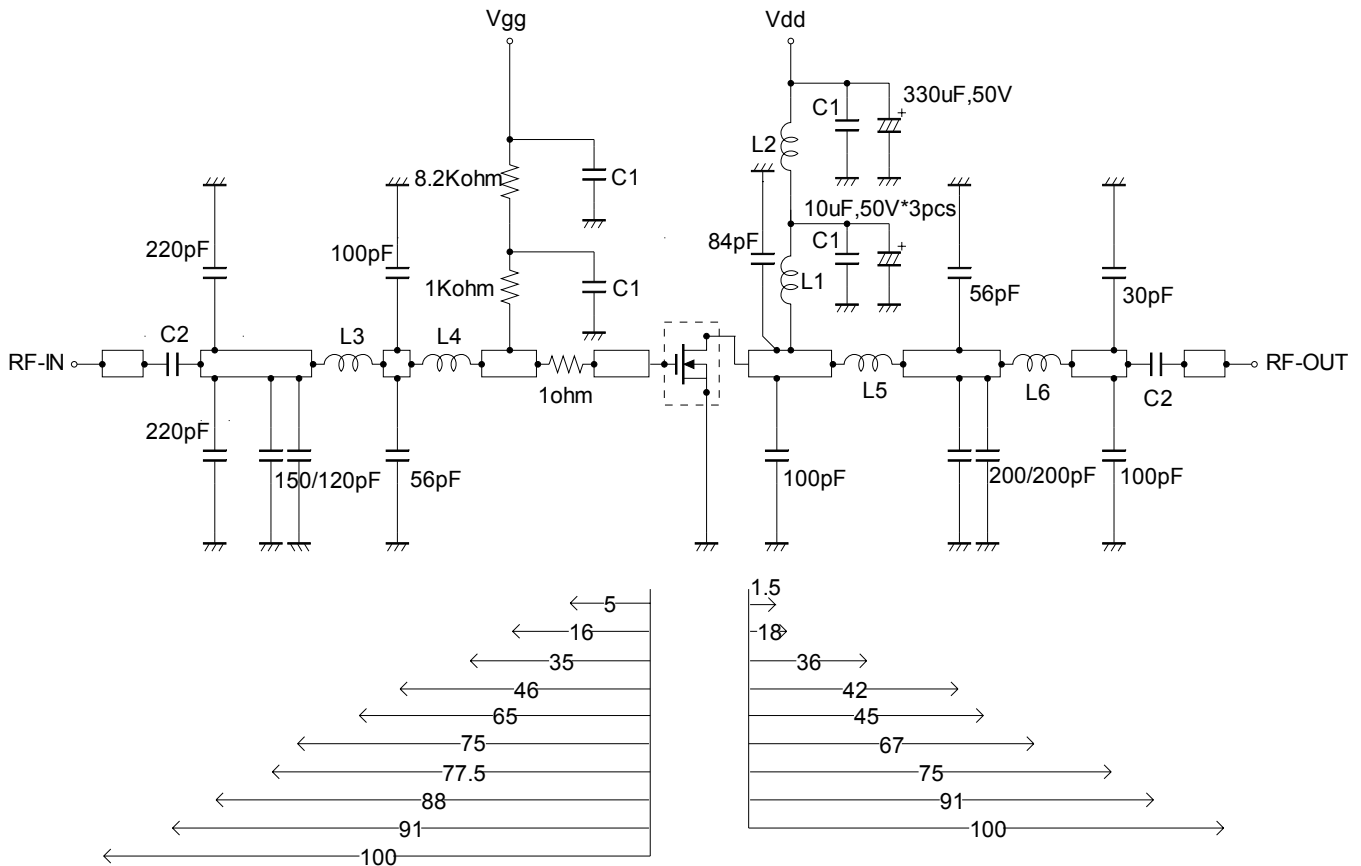

C1:100pF, 0.022uF, 0.1uF in parallel
C2:470pF*2 in parallel

Dimensions:mm

Note:Board material- teflon substrate

micro strip line width=4.2mm/50ohm,er:2.7,t=1.6mm

- L1:10Turns,I.D8mm,D0.9mm copper wire
- L2:10Turns,I.D6mm,D1.6mm silver plated copper wire
- L3:5Turns,I.D5.6mm,D0.9mm copper wire
- L4:6Turns,I.D5.6mm,D0.9mm copper wire
- L5:4Turns,I.D5.6mm,D0.9mm copper wire P=0.5mm
- L6:7Turns,I.D5.6mm,D0.9mm copper wire

INPUT/OUTPUT IMPEDANCE VS.FREQUENCY CHARACTERISTICS

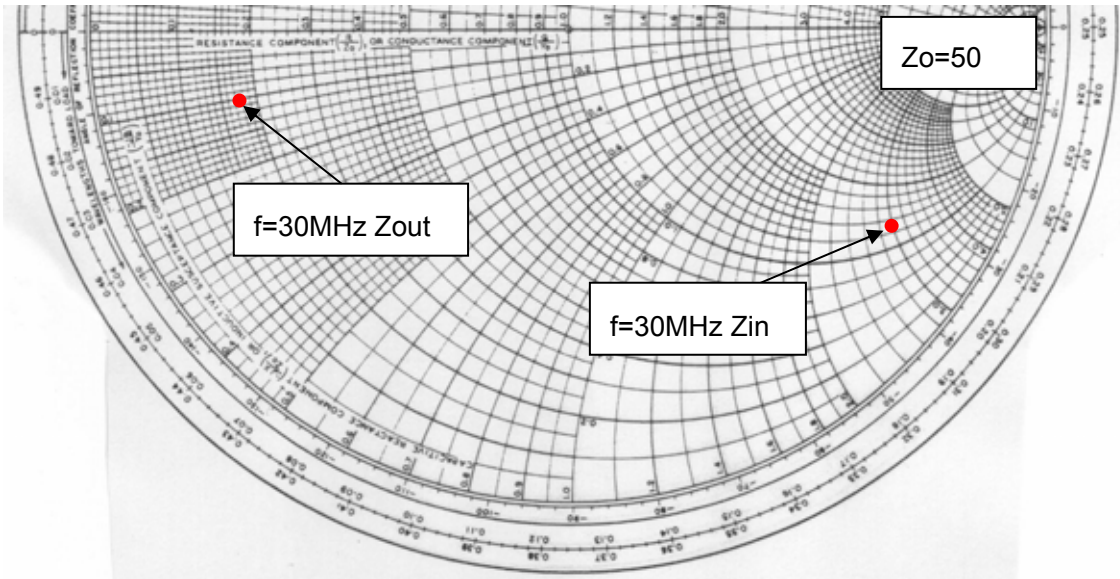

Zin , Zout

f	Zin	Zout	Conditions
(MHz)	(ohm)	(ohm)	
30	65.06-j150.9	8.75-j4.92	Po=10W, Vdd=12.5V,Pin=0.15W

RD06HHF1

RoHS Compliance, Silicon MOSFET Power Transistor 30MHz,6W

RD06HHF1 S-PARAMETER DATA (@Vdd=12.5V, Id=500mA)

Freq. [MHz]	S11		S21		S12		S22	
	(mag)	(ang)	(mag)	(ang)	(mag)	(ang)	(mag)	(ang)
10	0.985	-18.8	34.407	165.9	0.008	76.2	0.826	-17.3
30	0.900	-50.4	30.427	143.3	0.021	59.4	0.767	-43.6
50	0.799	-74.4	24.979	126.1	0.029	43.2	0.677	-65.0
100	0.667	-109.6	15.565	100.7	0.032	27.3	0.547	-96.8
150	0.636	-129.0	10.953	85.1	0.032	23.1	0.523	-113.4
200	0.630	-140.1	8.194	73.7	0.029	25.3	0.528	-124.7
250	0.645	-148.2	6.528	63.9	0.027	34.5	0.561	-132.7
300	0.663	-155.0	5.315	55.2	0.027	49.1	0.588	-139.6
350	0.685	-160.7	4.437	47.4	0.031	61.8	0.622	-145.9
400	0.708	-165.9	3.771	39.9	0.039	71.0	0.657	-151.7
450	0.729	-170.8	3.233	33.2	0.048	75.8	0.686	-157.0
500	0.752	-175.4	2.826	26.8	0.059	77.9	0.715	-162.3
550	0.771	179.9	2.475	20.7	0.070	76.9	0.743	-167.6
600	0.789	175.4	2.186	15.2	0.083	76.1	0.763	-172.3
650	0.804	171.2	1.943	9.7	0.095	73.7	0.789	-177.3
700	0.819	166.9	1.738	4.6	0.108	71.0	0.804	178.1
750	0.834	162.6	1.560	0.0	0.120	68.1	0.820	173.5
800	0.842	158.5	1.410	-4.5	0.133	65.0	0.837	169.0
850	0.851	154.3	1.275	-8.7	0.145	61.6	0.847	164.8
900	0.859	150.3	1.160	-12.6	0.157	58.2	0.858	160.2
950	0.866	146.2	1.058	-16.9	0.167	54.5	0.869	155.7
1000	0.870	142.3	0.963	-20.0	0.179	51.0	0.876	151.8

ATTENTION:

- 1.High Temperature ; This product might have a heat generation while operation,Please take notice that have a possibility to receive a burn to touch the operating product directly or touch the product until cold after switch off. At the near the product,do not place the combustibile material that have possibilities to arise the fire.
- 2.Generation of High Frequency Power ; This product generate a high frequency power. Please take notice that do not leakage the unnecessary electric wave and use this products without cause damage for human and property per normal operation.
- 3.Before use; Before use the product,Please design the equipment in consideration of the risk for human and electric wave obstacle for equipment.

PRECAUTIONS FOR THE USE OF MITSUBISHI SILICON RF POWER DEVICES:

1. The specifications of mention are not guarantee values in this data sheet. Please confirm additional details regarding operation of these products from the formal specification sheet. For copies of the formal specification sheets, please contact one of our sales offices.
2. RD series products (RF power transistors) are designed for consumer mobile communication terminals and were not specifically designed for use in other applications. In particular, while these products are highly reliable for their designed purpose, they are not manufactured under a quality assurance testing protocol that is sufficient to guarantee the level of reliability typically deemed necessary for critical communications elements. Examples of critical communications elements would include transmitters for base station applications and fixed station applications that operate with long term continuous transmission and a higher on-off frequency during transmitting, especially for systems that may have a high impact to society.
3. RD series products use MOSFET semiconductor technology. They are sensitive to ESD voltage therefore appropriate ESD precautions are required.
4. In the case of use in below than recommended frequency, there is possibility to occur that the device is deteriorated or destroyed due to the RF-swing exceed the breakdown voltage.
5. In order to maximize reliability of the equipment, it is better to keep the devices temperature low. It is recommended to utilize a sufficient sized heat-sink in conjunction with other cooling methods as needed (fan, etc.) to keep the channel temperature for RD series products lower than 120deg/C(in case of $T_{chmax}=150deg/C$), 140deg/C(in case of $T_{chmax}=175deg/C$) under standard conditions.
6. Do not use the device at the exceeded the maximum rating condition. In case of plastic molded devices, the exceeded maximum rating condition may cause blowout, smoldering or catch fire of the molding resin due to extreme short current flow between the drain and the source of the device. These results causes in fire or injury.
7. For specific precautions regarding assembly of these products into the equipment, please refer to the supplementary items in the specification sheet.
8. Warranty for the product is void if the products protective cap (lid) is removed or if the product is modified in any way from it's original form.
9. For additional "Safety first" in your circuit design and notes regarding the materials, please refer the last page of this data sheet.
10. Please refer to the additional precautions in the formal specification sheet.

Keep safety first in your circuit designs !

Mitsubishi Electric Corporation puts the maximum effort into making semiconductor products better and more reliable, but there is always the possibility that trouble may occur with them. Trouble with semiconductors may lead to personal injury, fire or property damage. Remember to give due consideration to safety when making your circuit designs, with appropriate measures such as (i) placement of substitutive, auxiliary circuits, (ii) use of non-flammable material or (iii) prevention against any malfunction or mishap.

Notes regarding these materials

- These materials are intended as a reference to assist our customers in the selection of the Mitsubishi semiconductor product best suited to the customer's application; they do not convey any license under any intellectual property rights, or any other rights, belonging to Mitsubishi Electric Corporation or a third party.
- Mitsubishi Electric Corporation assumes no responsibility for any damage, or infringement of any third-party's rights, originating in the use of any product data, diagrams, charts, programs, algorithms, or circuit application examples contained in these materials.
- All information contained in these materials, including product data, diagrams, charts, programs and algorithms represents information on products at the time of publication of these materials, and are subject to change by Mitsubishi Electric Corporation without notice due to product improvements or other reasons. It is therefore recommended that customers contact Mitsubishi Electric Corporation or an authorized Mitsubishi Semiconductor product distributor for the latest product information before purchasing a product listed herein. The information described here may contain technical inaccuracies or typographical errors. Mitsubishi Electric Corporation assumes no responsibility for any damage, liability, or other loss rising from these inaccuracies or errors. Please also pay attention to information published by Mitsubishi Electric Corporation by various means, including the Mitsubishi Semiconductor home page (<http://www.mitsubishichips.com>).
- When using any or all of the information contained in these materials, including product data, diagrams, charts, programs, and algorithms, please be sure to evaluate all information as a total system before making a final decision on the applicability of the information and products. Mitsubishi Electric Corporation assumes no responsibility for any damage, liability or other loss resulting from the information contained herein.
- Mitsubishi Electric Corporation semiconductors are not designed or manufactured for use in a device or system that is used under circumstances in which human life is potentially at stake. Please contact Mitsubishi Electric Corporation or an authorized Mitsubishi Semiconductor product distributor when considering the use of a product contained herein for any specific purposes, such as apparatus or systems for transportation, vehicular, medical, aerospace, nuclear, or undersea repeater use.
- The prior written approval of Mitsubishi Electric Corporation is necessary to reprint or reproduce in whole or in part these materials.
- If these products or technologies are subject to the Japanese export control restrictions, they must be exported under a license from the Japanese government and cannot be imported into a country other than the approved destination. Any diversion or reexport contrary to the export control laws and regulations of Japan and/or the country of destination is prohibited.
- Please contact Mitsubishi Electric Corporation or an authorized Mitsubishi Semiconductor product distributor for further details on these materials or the products contained therein.