

System Lens Driver Series for Digital Still Cameras / Single-lens Reflex Cameras



7ch System Lens Drivers for Digital Still Cameras / Single-lens Reflex Cameras

BD6757KN, BD6889GU

No.09014EAT04

●Description

BD6757KN and BD6889GU motor drivers provide 6 Full-ON Drive H-bridge channels and 1 Linear Constant-Current Drive H-bridge channel. Stepping motors can be used for the auto focus, zoom, and iris, making it possible to configure a sophisticated, high precision lens drive system. ROHM's motor drivers are both compact, multifunctional, and enable advanced features such as lens barrier and anti shock.

●Features

- 1) Subminiature grid array package: $5.0 \times 5.0 \times 1.2\text{mm}^3$ (BD6889GU)
- 2) DMOS output allowing a range power supply: 2.0V to 8.0V (BD6757KN)
- 3) Low ON-Resistance Power MOS output:
Full-ON Drive block with 1.3Ω Typ. and Linear Constant-Current Drive block with 0.9Ω Typ. (BD6757KN, BD6889GU)
- 4) Built-in two digital NPN transistor circuits for photo-interrupter waveform shaping:
Input-dividing type with output pull-up resistance (BD6757KN)
- 5) Built-in four digital NPN transistor circuits for photo-interrupter waveform shaping:
Input-dividing type with output pull-up resistance (BD6889GU)
- 6) Built-in four digital PNP transistor circuits for photo-interrupter waveform shaping:
Input-dividing type with output pull-down resistance (BD6889GU)
- 7) Built-in voltage-regulator circuit for photo-interrupter (BD6889GU)
- 8) Built-in two-step output current setting switch for the Linear Constant-Current Drive block (BD6757KN)
- 9) $0.9V \pm 2\%$ high-precision reference voltage output
- 10) Constant-Current Drive block features phase compensation capacitor-free design
- 11) Built-in $\pm 3\%$ high-precision Linear Constant-Current Driver
- 12) Built-in charge pump circuit for the DMOS gate voltage drive (BD6757KN)
- 13) UVLO (Under Voltage Lockout Protection) function
- 14) Built-in TSD (Thermal Shut Down) circuit
- 15) Standby current consumption: $0\mu\text{A}$ (Typ.)

●Absolute Maximum Ratings

Parameter	Symbol	Limit		Unit
		BD6757KN	BD6889GU	
Power supply voltage	VCC	-0.5 to +7.0	-0.5 to +7.0	V
Motor power supply voltage	VM	-0.5 to +10.0	-0.5 to +7.0	V
Charge pump voltage	VG	15.0	None	V
Control input voltage	VIN	-0.5 to VCC+0.5	-0.5 to VCC+0.5	V
Power dissipation	Pd	950^{*1}	980^{*2}	mW
Operating temperature range	Topr	-25 to +75	-25 to +85	°C
Junction temperature	Tjmax	+150	+150	°C
Storage temperature range	Tstg	-55 to +150	-55 to +150	°C
H-bridge output current	Iout	-800 to +800 ^{*3}	-800 to +800 ^{*3}	mA/ch

*1 Reduced by $7.6\text{mW}/^\circ\text{C}$ over 25°C , when mounted on a glass epoxy board ($70\text{mm} \times 70\text{mm} \times 1.6\text{mm}$).

*2 Reduced by $7.84\text{mW}/^\circ\text{C}$ over 25°C , when mounted on a glass epoxy board ($70\text{mm} \times 70\text{mm} \times 1.6\text{mm}$).

*3 Must not exceed Pd, ASO, or Tjmax of 150°C .

●Operating Conditions (Ta=-25 to +75°C(BD6757KN), -25 to +85°C(BD6889GU))

Parameter	Symbol	Limit		Unit
		BD6757KN	BD6889GU	
Power supply voltage	VCC	2.5 to 5.5	2.5 to 5.7	V
Motor power supply voltage	VM	2.5 to 8.0	2.5 to 5.7	V
Control input voltage	VIN	0 to VCC	0 to VCC	V
H-bridge output current	Iout	-500 to +500 ^{*4}	-500 to +500 ^{*4}	mA/ch

*4 Must not exceed Pd or ASO.

●Electrical Characteristics

1) BD6757KN Electrical Characteristics (Unless otherwise specified, Ta=25°C, VCC=3.0V, VM=5.0V)

Parameter	Symbol	Limit			Unit	Conditions
		Min.	Typ.	Max.		
Overall						
Circuit current during standby operation	ICCST	-	0	10	μA	PS=0V
Circuit current	ICC	-	1.0	3.0	mA	PS=VCC with no signal
Control input (IN=PS, IN1A to IN7B, and LIMSW)						
High level input voltage	VINH	2.0	-	-	V	
Low level input voltage	VINL	-	-	0.7	V	
High level input current	IINH	15	30	60	μA	VINH=3V
Low level input current	IINL	-1	0	-	μA	VINL=0V
Pull-down resistor	RIN	50	100	200	kΩ	
Charge pump						
Charge pump voltage	VCP	10	11	-	V	
UVLO						
UVLO voltage	VUVLO	1.6	-	2.4	V	
Full-ON Drive block (ch1 to ch6)						
Output ON-Resistance	RON	-	1.3	1.6	Ω	Io=±400mA on high and low sides in total
Pulse input response	tp	100	-	-	ns	With an input pulse with of 200ns
Linear Constant-Current Drive block (ch7)						
Output ON-Resistance	RON	-	0.9	1.1	Ω	Io=±400mA on high and low sides in total
VREF output voltage	VREF	0.88	0.90	0.92	V	Iout=0~1mA
Output limit current 1	IOL1	388	400	412	mA	RNF=0.5Ω with a load of 10Ω VLIMH(L)=0.2V, LIMSW=0V(3V)
Output limit current 2	IOL2	285	300	315	mA	RNF=0.5Ω with a load of 10Ω VLIMH(L)=0.15V, LIMSW=0V(3V) ^{※5}
Output limit current 3	IOL3	190	200	210	mA	RNF=0.5Ω with a load of 10Ω VLIMH(L)=0.1V, LIMSW=0V(3V) ^{※5}
Digital NPN transistor block for photo-interrupter waveform shaping						
Input current	ISIH	-	-	0.1	mA	SIx=3V
Low level output voltage	VSOL	-	0.1	0.25	V	SIx=3V, ISO=0.5mA
Input dividing resistance	RSIL	70	100	130	kΩ	
Output pull-up resistance	RSOH	5	10	20	kΩ	
Input dividing resistance comparison	-	0.8	1.0	1.2	-	Division resistance comparison between SIx and GND ^{※5}

※5 Design target value (Not all shipped devices are fully tested.)

2) BD6889GU Electrical Characteristics (Unless otherwise specified, Ta=25°C, VCC=3.0V, VM=5.0V)

Parameter	Symbol	Limit			Unit	Conditions
		Min.	Typ.	Max.		
Overall						
Circuit current during standby operation	ICCST	-	0	10	μA	PS=0V
Circuit current	ICC	-	1.5	3.0	mA	PS=VCC with no signal
Control input (IN=PS, IN1A to IN7B, SW, DSW, DSEL1, and DSEL2)						
High level input voltage	VINH	2.0	-	-	V	
Low level input voltage	VINL	-	-	0.7	V	
High level input current	IINH	15	30	60	μA	VINH=3V
Low level input current	IINL	-1	0	-	μA	VINL=0V
Pull-down resistor	RIN	50	100	200	kΩ	
UVLO						
UVLO voltage	VUVLO	1.6	-	2.4	V	
Full-ON Drive block (ch1 to ch6)						
Output ON-Resistance	RON	-	1.3	1.6	Ω	I _o =±400mA on high and low sides in total
Pulse input response	t _p	100	-	-	ns	With an input pulse with of 200ns
Linear Constant-Current Drive block (ch7)						
Output ON-Resistance	RON	-	0.9	1.1	Ω	I _o =±400mA on high and low sides in total
VREF output voltage	VREF	0.88	0.90	0.92	V	I _{out} =0~1mA
Output limit current 1	IOL1	388	400	412	mA	RNF=0.5Ω with a load of 10Ω, VLIM=0.2V
Output limit current 2	IOL2	285	300	315	mA	RNF=0.5Ω with a load of 10Ω, VLIM=0.15V
Output limit current 3	IOL3	190	200	210	mA	RNF=0.5Ω with a load of 10Ω, VLIM=0.1V
Digital NPN transistor block for photo-interrupter waveform shaping						
Input current	ISIH	-	-	0.1	mA	Slx=3V
Low level output voltage	VSOL	-	0.1	0.25	V	Slx=3V, ISO=0.5mA
Input dividing resistance	RSIN	70	100	130	kΩ	
Output pull-up resistance	RSOH	23	33	43	kΩ	
Input dividing resistance comparison	-	0.8	1.0	1.2	-	Division resistance comparison between Slx and GND ^{※6}
Digital PNP transistor block for photo-interrupter waveform shaping						
Input current	ISIL	-0.1	-	-	mA	Slx=0V
High level output voltage	VSOH	VCC-0.25	VCC-0.1	-	V	Slx=0V, ISO=-0.5mA
Input dividing resistance	RSIP	70	100	130	kΩ	
Output pull-down resistance	RSOL	23	33	43	kΩ	
Input dividing resistance comparison	-	0.8	1.0	1.2	-	Division resistance comparison between Slx and VCC ^{※6}
Voltage-regulator for photo-interrupter						
High level output voltage	VREGH	VCC-0.25	VCC-0.2	-	V	I _{REG} =100mA
Output ON-Resistance	RONREG	-	2	2.5	Ω	I _{REG} =100mA
Output leak current	ILPI	-	0	1	μA	SW=VCC

※6 Design target value (Not all shipped devices are fully tested.)

●Electrical Characteristic Diagrams

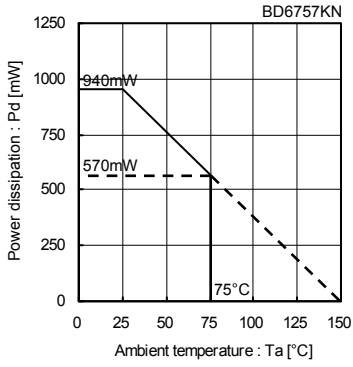

Fig.1 Power Dissipation Reduction

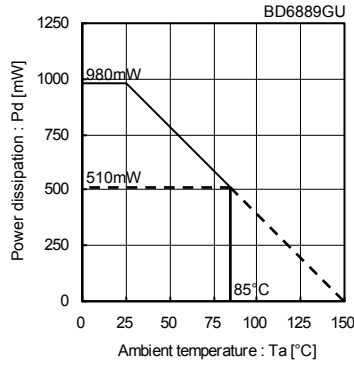

Fig.2 Power Dissipation Reduction

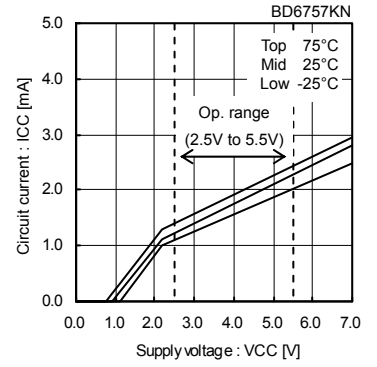

Fig.3 Circuit current

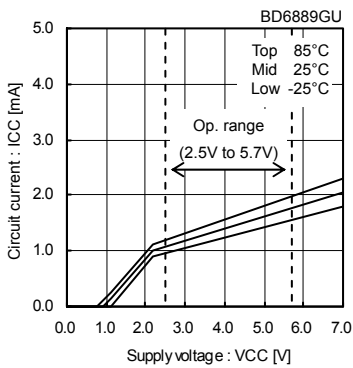

Fig.4 Circuit current

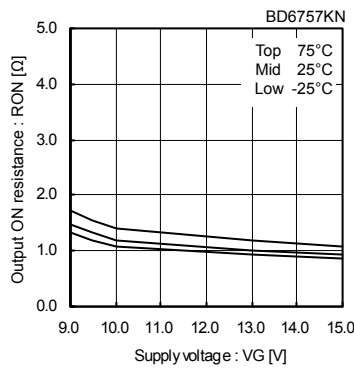

Fig.5 Output ON-Resistance (Full-ON Drive block)

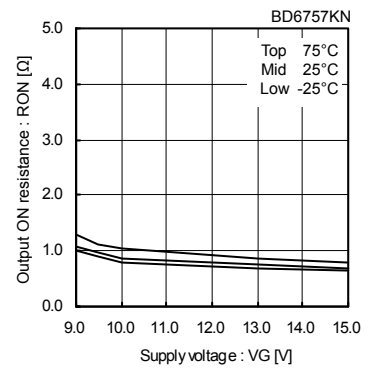

Fig.6 Output ON-Resistance (Linear Constant-Current Drive block)

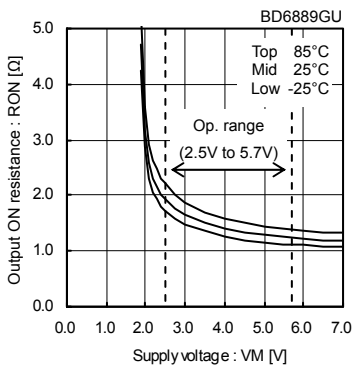

Fig.7 Output ON-Resistance (Full-ON Drive block)

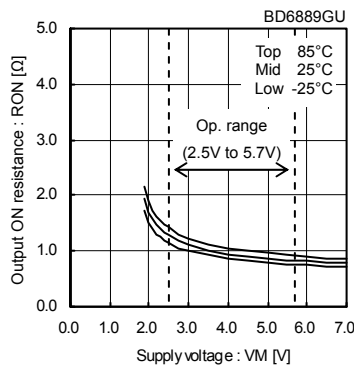

Fig.8 Output ON-Resistance (Linear Constant-Current Drive block)

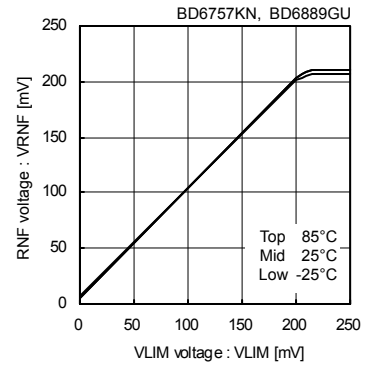

Fig.9 Output limit voltage (RNF=0.5Ω)

●Pin arrangement and Pin Function

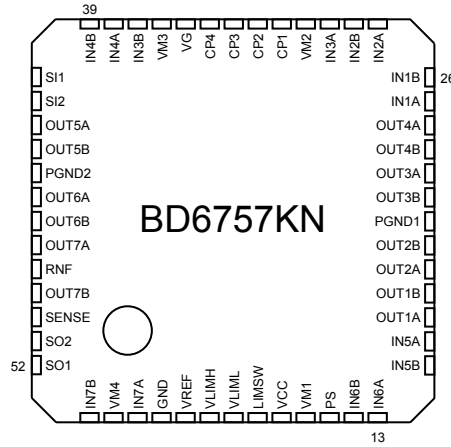

Fig.10 BD6757KN Pin Arrangement (Top View)
UQFN52 Package

BD6757KN Pin Function Table

No.	Pin Name	Function	No.	Pin Name	Function
1	IN7B	Control input pin ch7 B	27	IN2A	Control input pin ch2 A
2	VM4	Motor power supply pin ch7	28	IN2B	Control input pin ch2 B
3	IN7A	Control input pin ch7 A	29	IN3A	Control input pin ch3 A
4	GND	Ground Pin	30	VM2	Motor power supply pin ch3 and ch4
5	VREF	Reference voltage output pin	31	CP1	Charge pump capacitor connection pin 1
6	VLIMH	Output current setting pin 1 ch7	32	CP2	Charge pump capacitor connection pin 2
7	VLIML	Output current setting pin 2 ch7	33	CP3	Charge pump capacitor connection pin 3
8	LIMSW	Output current setting selection pin ch7	34	CP4	Charge pump capacitor connection pin 4
9	VCC	Power supply pin	35	VG	Charge pump output pin
10	VM1	Motor power supply pin ch1 and ch2	36	VM3	Motor power supply pin ch5 and ch6
11	PS	Power-saving pin	37	IN3B	Control input pin ch3 B
12	IN6B	Control input pin ch6 B	38	IN4A	Control input pin ch4 A
13	IN6A	Control input pin ch6 A	39	IN4B	Control input pin ch4 B
14	IN5B	Control input pin ch5 B	40	SI1	Digital transistor input pin 1
15	IN5A	Control input pin ch5 A	41	SI2	Digital transistor input pin 2
16	OUT1A	H-bridge output pin ch1 A	42	OUT5A	H-bridge output pin ch5 A
17	OUT1B	H-bridge output pin ch1 B	43	OUT5B	H-bridge output pin ch5 B
18	OUT2A	H-bridge output pin ch2 A	44	PGND2	Motor ground pin ch5 and ch6
19	OUT2B	H-bridge output pin ch2 B	45	OUT6A	H-bridge output pin ch6 A
20	PGND1	Motor ground pin ch1 to ch4	46	OUT6B	H-bridge output pin ch6 B
21	OUT3B	H-bridge output pin ch3 B	47	OUT7A	H-bridge output pin ch7 A
22	OUT3A	H-bridge output pin ch3 A	48	RNF	Resistance connection pin for output current detection ch7
23	OUT4B	H-bridge output pin ch4 B	49	OUT7B	H-bridge output pin ch7 B
24	OUT4A	H-bridge output pin ch4 A	50	SENSE	Output current detection pin ch7
25	IN1A	Control input pin ch1 A	51	SO2	Digital transistor output pin 2
26	IN1B	Control input pin ch1 B	52	SO1	Digital transistor output pin 1

	1	2	3	4	5	6	7	8
A	N.C.	OUT6A	OUT6B	VM3	PGND3	OUT5B	OUT5A	N.C.
B		DSW	IN6A	IN6B	SO4P	SO4N	REG	OUT4A
C	OUT7A	SW	DSEL2	IN7A	SI4	IN5A	PS	OUT4B
D	VM4	VCC	VREF	IN7B	IN5B	SI3	SO3P	VM2
E	RNF	DSEL1	IN1A	IN1B	IN4B	IN4A	SO3N	PGND2
F	SENSE	VLIM	IN2A	SI1	SI2	IN3A	IN3B	OUT3B
G	OUT7B	GND	IN2B	SO1P	SO1N	SO2P	SO2N	OUT3A
H	N.C.	OUT1A	OUT1B	PGND1	VM1	OUT2B	OUT2A	N.C.

Fig.11 BD6889GU Pin Arrangement (Top View)
VBGA063T050 Package

BD6889GU Pin Function Table

No.	Pin Name	Function	No.	Pin Name	Function
A1	N.C.	-	E1	RNF	Resistance connection pin for output current detection ch7
A2	OUT6A	H-bridge output pin ch6 A	E2	DSEL1	Selection pin for transistor output 1
A3	OUT6B	H-bridge output pin ch6 B	E3	IN1A	Control input pin ch1 A
A4	VM3	Motor power supply pin ch5 and ch6	E4	IN1B	Control input pin ch1 B
A5	PGND3	Motor ground pin ch5 and ch6	E5	IN4B	Control input pin ch4 B
A6	OUT5B	H-bridge output pin ch5 B	E6	IN4A	Control input pin ch4 A
A7	OUT5A	H-bridge output pin ch5 A	E7	SO3N	NPN transistor output pin 3
A8	N.C.	-	E8	PGND2	Motor ground pin ch3 and ch4
B1			F1	SENSE	Output current detection pin ch7
B2	DSW	Enable input pin for transistor	F2	VLIM	Output current setting ch7
B3	IN6A	Control input pin ch6 A	F3	IN2A	Control input pin ch2 A
B4	IN6B	Control input pin ch6 B	F4	SI1	Digital transistor input pin 1
B5	SO4P	PNP transistor output pin 4	F5	SI2	Digital transistor input pin 2
B6	SO4N	NPN transistor output pin 4	F6	IN3A	Control input pin ch3 A
B7	REG	Regulator output pin for PI	F7	IN3B	Control input pin ch3 B
B8	OUT4A	H-bridge output pin ch4 A	F8	OUT3B	H-bridge output pin ch3 B
C1	OUT7A	H-bridge output pin ch7 A	G1	OUT7B	H-bridge output pin ch7 B
C2	SW	Regulator input pin for PI	G2	GND	Ground pin
C3	DSEL2	Selection pin for transistor output 2	G3	IN2B	Control input pin ch2 B
C4	IN7A	Control input pin ch7 A	G4	SO1P	PNP transistor output pin 1
C5	SI4	Digital transistor input pin 4	G5	SO1N	NPN transistor output pin 1
C6	IN5A	Control input pin ch5 A	G6	SO2P	PNP transistor output pin 2
C7	PS	Power-saving pin	G7	SO2N	NPN transistor output pin 2
C8	OUT4B	H-bridge output pin ch4 B	G8	OUT3A	H-bridge output pin ch3 A
D1	VM4	Motor power supply pin ch7	H1	N.C.	-
D2	VCC	Power supply pin	H2	OUT1A	H-bridge output pin ch1 A
D3	VREF	Reference voltage output pin	H3	OUT1B	H-bridge output pin ch1 B
D4	IN7B	Control input pin ch7 B	H4	PGND1	Motor ground pin ch1 and ch2
D5	IN5B	Control input pin ch5 B	H5	VM1	Motor power supply pin ch1 and ch2
D6	SI3	Digital transistor input pin 3	H6	OUT2B	H-bridge output pin ch2 B
D7	SO3P	PNP transistor output pin 3	H7	OUT2A	H-bridge output pin ch2 A
D8	VM2	Motor power supply pin ch3 and ch4	H8	N.C.	-

●Application Circuit Diagram

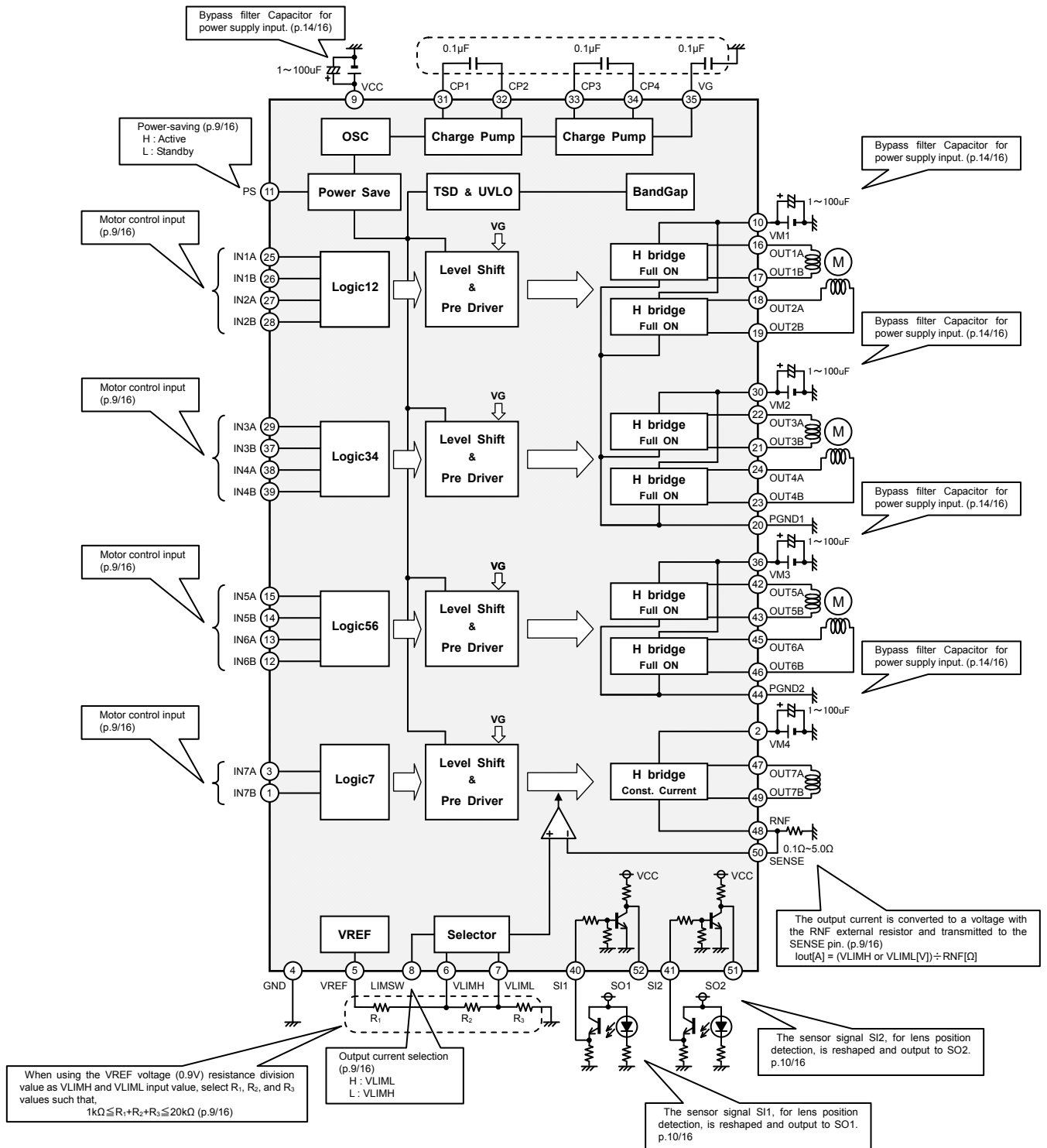

Fig.12 BD6757KN Application Circuit Diagram

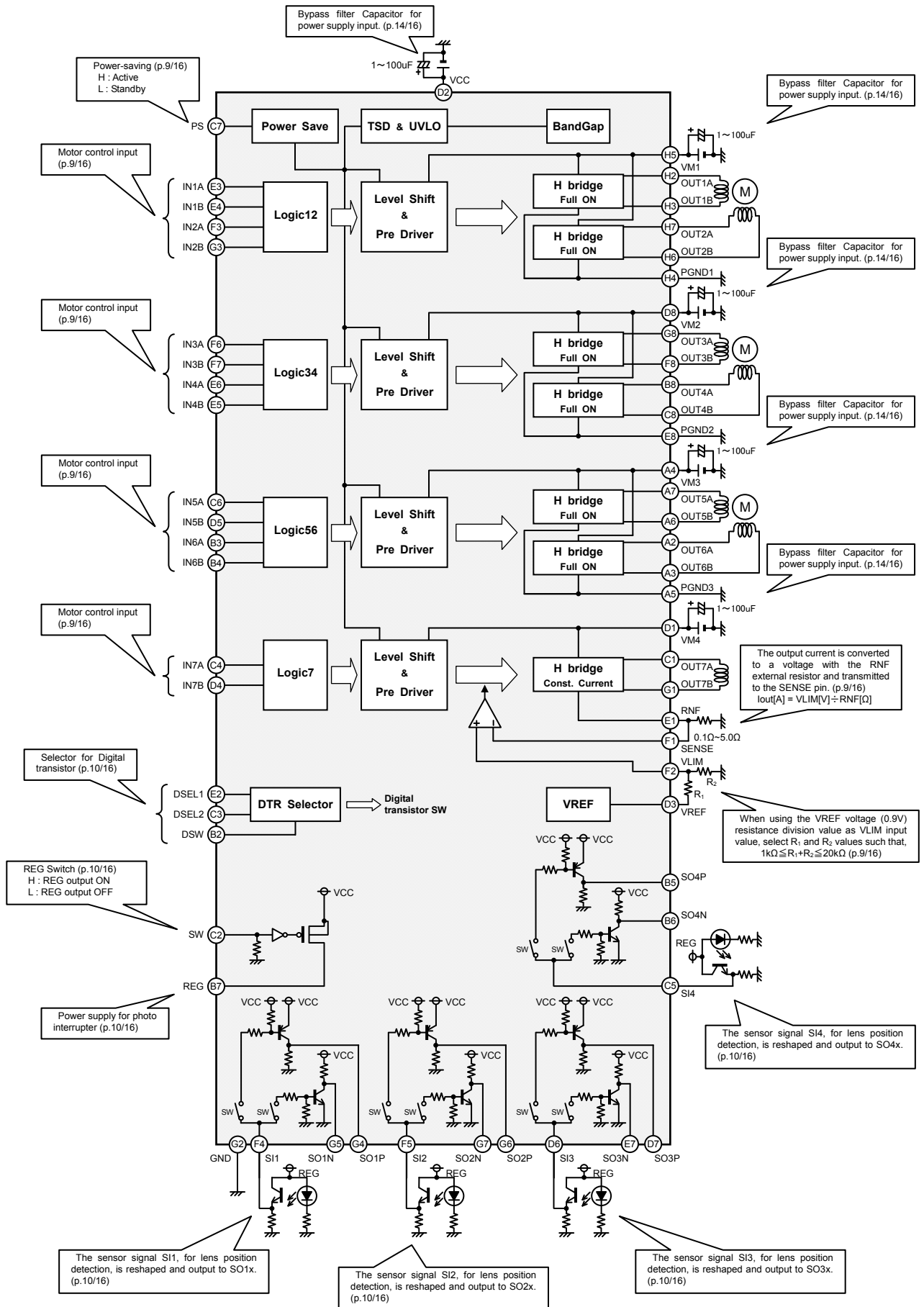

Fig.13 BD6889GU Application Circuit Diagram

●Function Explanation

1) Power-saving function

When Low-level voltage is applied to PS pin, the IC will be turned off internally and the circuit current will be 0μA (Typ.). During operating mode, PS pin should be High-level. (See the Electrical Characteristics; p.2/16 and p.3/16)

2) Motor Control input

(1) INxA and INxB pins

These pins are used to program and control the motor drive modes. The Full-ON drivers and the Linear Constant-Current driver use IN/IN and EN/IN input modes, respectively. (See the Electrical Characteristics; p.2/16 and p.3/16, and I/O Truth Table; p.10/16)

3) H-bridge

The 7-channel H-bridges can be controlled independently. For this reason, it is possible to drive the H-bridges simultaneously, as long as the package thermal tolerances are not exceeded.

The H-bridge output transistors of the BD6757KN and BD6889GU consist of Power DMOS, with the charge pump step-up power supply VG, and Power CMOS, with the motor power supply VM, respectively. The total H-bridge ON-Resistance on the high and low sides varies with the VG and VM voltages, respectively. The system must be designed so that the maximum H-bridge current for each channel is 800mA or below. (See the Operating Conditions; p.1/16)

4) Drive system of Linear Constant-Current H-bridge (BD6757KN: ch7 and BD6889GU: ch7)

BD6757KN (ch7) and BD6889GU (ch7) enable Linear Constant-Current Driving.

(1) Reference voltage output (with a tolerance of ±2%)

The VREF pin outputs 0.9V, based on the internal reference voltage. The output current of the Constant-Current Drive block is controllable by connecting external resistance to the VREF pin of the IC and applying a voltage divided by the resistor to the output current setting pins. (BD6757KN: VLIMH and VLIML pins, BD6889GU: VLIM pin) It is recommended to set the external resistance to 1kΩ or above in consideration of the current capacity of the VREF pin, and 20kΩ or below in order to minimize the fluctuation of the set value caused by the base current of the internal transistor of the IC.

(2) Output current settings and setting changes (BD6757KN)

When the Low-level control voltage is applied to the LIMSW pin, the value on the VLIMH pin will be used as an output current set value to control the output current. When the High-level control voltage is applied to the LIMSW pin, the value on the VLIML pin will be used as an output current set value to control the output current. (See the Electrical Characteristics; P.2/16)

(3) Output current detection and current settings

By connecting external resistor (0.1Ω to 5.0Ω) to the RNF pin of the IC, the motor drive current will be converted into voltage in order to be detected. The output current is kept constant by shorting the RNF and SENSE pins and comparing the voltage with the VLIMH or VLIML voltage (VLIM voltage in the case of the BD6889GU). To perform output current settings more precisely, trim the external RNF resistance if needed, and supply a precise voltage externally to the VLIMH or VLIML pin of the IC (VLIM pin in the case of the BD6889GU). In that case, open the VREF pin.

$$\text{Output current value } I_{out}[A] = \begin{cases} \frac{\text{VLIMH}[V] \text{ or } \text{VLIML}[V]}{\text{RNF}[\Omega]} \left(\begin{array}{l} \text{Select VLIMH when LIMSW is Low-level} \\ \text{Select VLIML when LIMSW is High-level} \end{array} \right) & (\text{BD6757KN}) \\ \frac{\text{VLIM}[V]}{\text{RNF}[\Omega]} & (\text{BD6889GU}) \end{cases} \dots\dots(1)$$

The output current is 400mA±3% if 0.2V is applied to the VLIMH or VLIML pin (VLIM pin in the case of the BD6889GU) and a 0.5Ω resistor is connected externally to the RNF pin.

If the VLIMH and VLIML pins (VLIM pin in the case of the BD6889GU) are shorted to the VCC pin (or the same voltage level as the VCC is applied) and the SENSE and RNF pins are shorted to the ground, this channel can be used as a Full-ON Drive H-bridge like the other six channels.

5) Charge pump (BD6757KN)

Each output H-bridge of the BD6757KN on the high and low sides consists of Nch DMOS. Therefore, the gate voltage VG should be higher than the VM voltage to drive the Nch DMOS on the high side.

The BD6757KN has a built-in charge pump circuit that generates VG voltage by connecting an external capacitor (0.01μF to 0.1μF).

If a 0.1μF capacitor is connected between: CP1 and CP2, CP3 and CP4, VG and GND

Then, VG pin output voltage will be: $VM1 + (VCC \times 2)$

If a 0.1μF capacitor is connected between: CP1 and CP2, VG and GND

CP4 and VG pins are shorted, and CP3 pin is open

Then, VG pin output voltage will be: $VM1 + VCC$

The VM1 to VM4 respectively can be set to voltages different to one another. In order to ensure better performance, the voltage differential between VG and VM must be 4.5V or higher, and the VG voltage must not exceed the absolute maximum rating of 15V.

- 6) Digital transistor for photo-interrupter waveform shaping (BD6757KN and BD6889GU)
 The BD6757KN, and BD6889GU build in two digital NPN transistor circuits, and eight digital NPN and PNP transistor circuits for photo-interrupter waveform shaping, respectively. The sensor signal, for lens position detection, is reshaped and output to the DSP. The input (SIx pin) is a dividing resistance type, and provided with NPN output (SOxN pin) pull-up resistor and PNP output (SOxP pin) pull-down resistor. This is so that VCC, and GND voltage will be NPN output, and PNP output, respectively, when the input is open. In the case of the BD6889GU, DSW, DSEL1, and DSEL2 pins can control the switching of NPN and PNP transistor. The inputs are provided with input pull-down resistor. This is so that GND voltage will be input, when these three pins are open. (See I/O Truth Table; P.12/16)

- 7) Voltage-regulator for photo-interrupter (BD6889GU)
 The BD6889GU builds in voltage-regulator circuits for photo-interrupter. When High-level voltage is applied to SW pin, the REG pin will be turned on. The input is provided with input pull-down resistor. This is so that REG pin will be turn off, when the input is open.

● I/O Truth Table

BD6757KN and BD6889GU Full-ON Driver ch1 to ch6 I/O Truth Table

Drive mode	INPUT		OUTPUT		Output mode
	INxA	INxB	OUTxA	OUTxB	
IN/IN	L	L	Z	Z	Standby
	H	L	H	L	CW
	L	H	L	H	CCW
	H	H	L	L	Brake

L: Low, H: High, X: Don't care, Z: High impedance
 At CW, current flows from OUTA to OUTB. At CCW, current flows from OUTB to OUTA.

BD6757KN and BD6889GU Linear Constant-Current Driver ch7 I/O Truth Table

Drive mode	INPUT		OUTPUT		Output mode
	IN7A	IN7B	OUT7A	OUT7B	
EN/IN	L	X	Z	Z	Standby
	H	L	H	L	CW
	H	H	L	H	CCW

L: Low, H: High, X: Don't care, Z: High impedance
 At CW, current flows from OUTA to OUTB. At CCW, current flows from OUTB to OUTA.

BD6889GU Digital Transistor I/O Truth Table

	INPUT			OUTPUT							
	DSW	DSEL1	DSEL2	PNP1	NPN1	PNP2	NPN2	PNP3	NPN3	PNP4	NPN4
Logic	L	X	X	OFF	OFF	OFF	OFF	OFF	OFF	OFF	OFF
	H	L	L	OFF	ON	OFF	ON	OFF	ON	OFF	ON
	H	L	H	OFF	ON	OFF	ON	ON	OFF	ON	OFF
	H	H	L	ON	OFF	ON	OFF	OFF	ON	OFF	ON
	H	H	H	ON	OFF	ON	OFF	ON	OFF	ON	OFF

L: Low, H: High, X: Don't care, OFF: GND (in the case of PNP), VCC (in the case of NPN)
 PNPx output to SOxP terminal, NPNx output to SOxN terminal

In the case of drive the Stepping Motor using ch1 and ch2 IN/IN input mode of the BD6757KN and BD6889GU
2 Phases

INPUT				OUTPUT				Output mode ch1 / ch2
IN1A	IN1B	IN2A	IN2B	OUT1A	OUT1B	OUT2A	OUT2B	
L	L	L	L	Z	Z	Z	Z	Stand by
H	L	H	L	H	L	H	L	1. CW / CW
L	H	H	L	L	H	H	L	3. CCW / CW
L	H	L	H	L	H	L	H	5. CCW / CCW
H	L	L	H	H	L	L	H	7. CW / CCW

L: Low, H: High, X: Don't care, Z: High impedance
At CW, current flows from OUTA to OUTB. At CCW, current flows from OUTB to OUTA.

1-2 Phases

INPUT				OUTPUT				Output mode ch1 / ch2
IN1A	IN1B	IN2A	IN2B	OUT1A	OUT1B	OUT2A	OUT2B	
L	L	L	L	Z	Z	Z	Z	Stand by
H	L	H	L	H	L	H	L	1. CW / CW
L	L	H	L	Z	Z	H	L	2. Z / CW
L	H	H	L	L	H	H	L	3. CCW / CW
L	H	L	L	L	H	Z	Z	4. CCW / Z
L	H	L	H	L	H	L	H	5. CCW / CCW
L	L	L	H	Z	Z	L	H	6. Z / CCW
H	L	L	H	H	L	L	H	7. CW / CCW
H	L	L	L	H	L	Z	Z	8. CW / Z

L: Low, H: High, X: Don't care, Z: High impedance
At CW, current flows from OUTA to OUTB. At CCW, current flows from OUTB to OUTA.

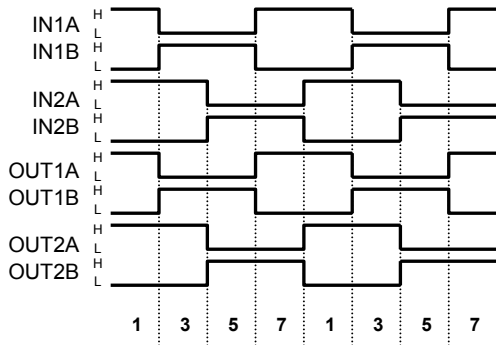

Fig.14 2 Phases Timing Sequence with IN/IN Input

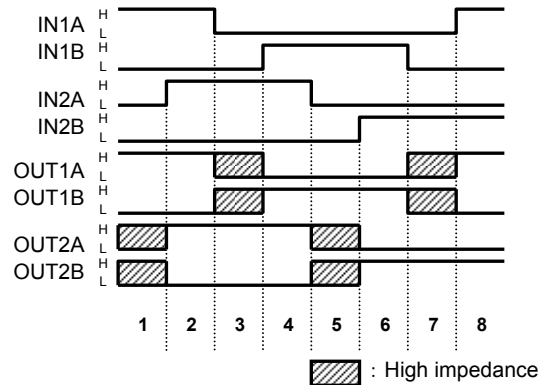

Fig.15 1-2 Phases Timing Sequence with IN/IN Input

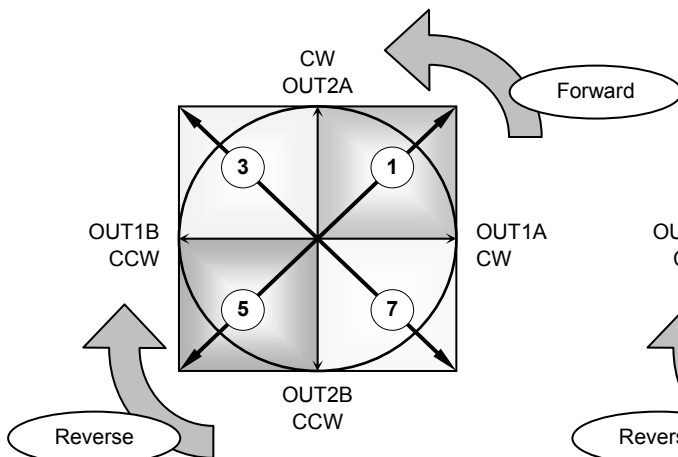

Fig.16 Torque Vector of 2 Phases Mode

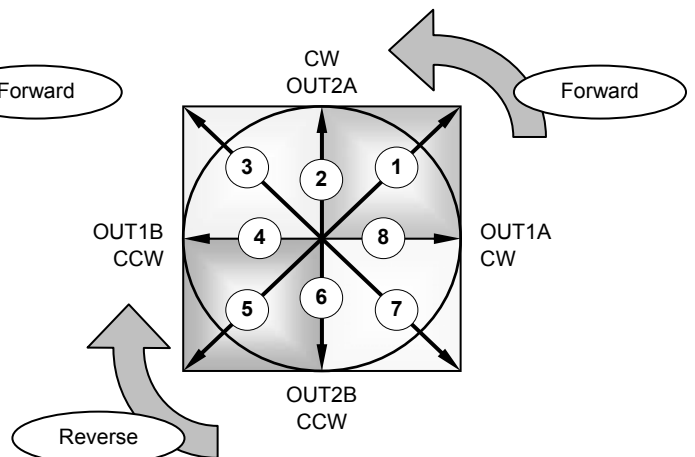

Fig.17 Torque Vector of 1-2 Phases Mode

● I/O Circuit Diagram

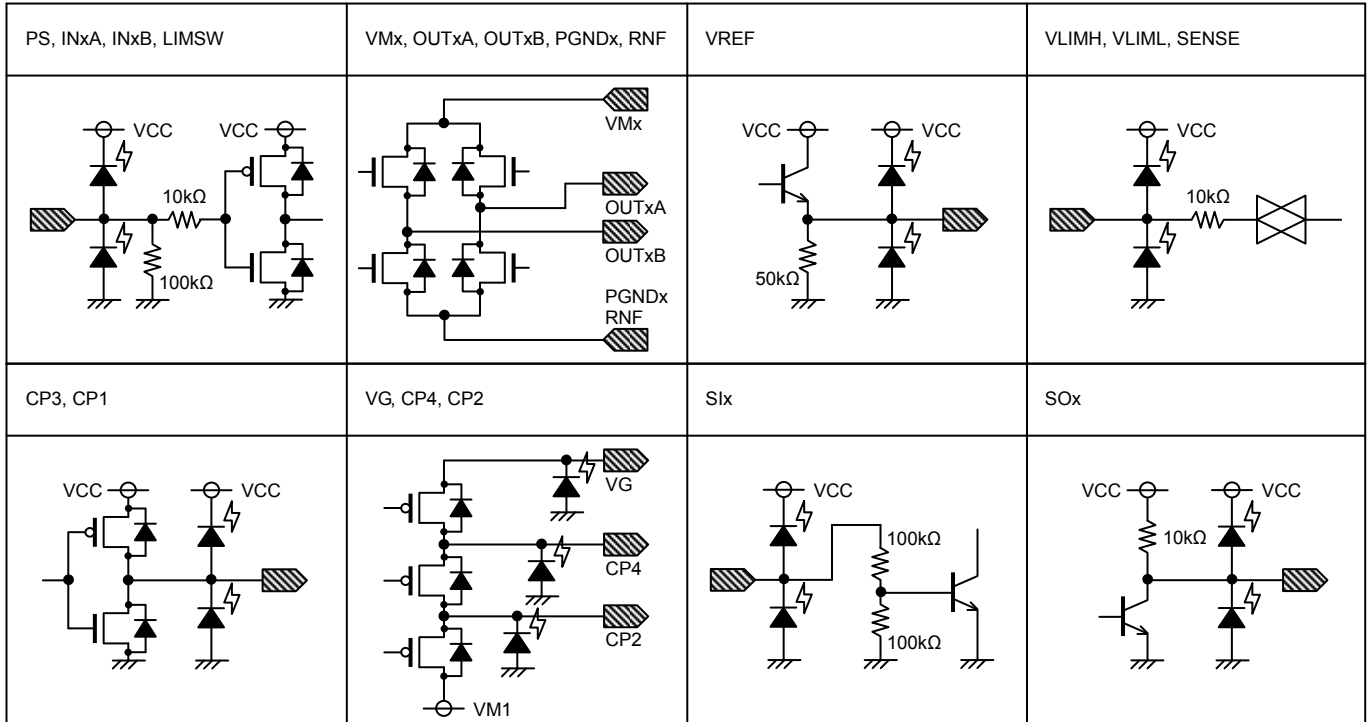

Fig.18 BD6757KN I/O Circuit Diagram (Resistance values are typical ones)

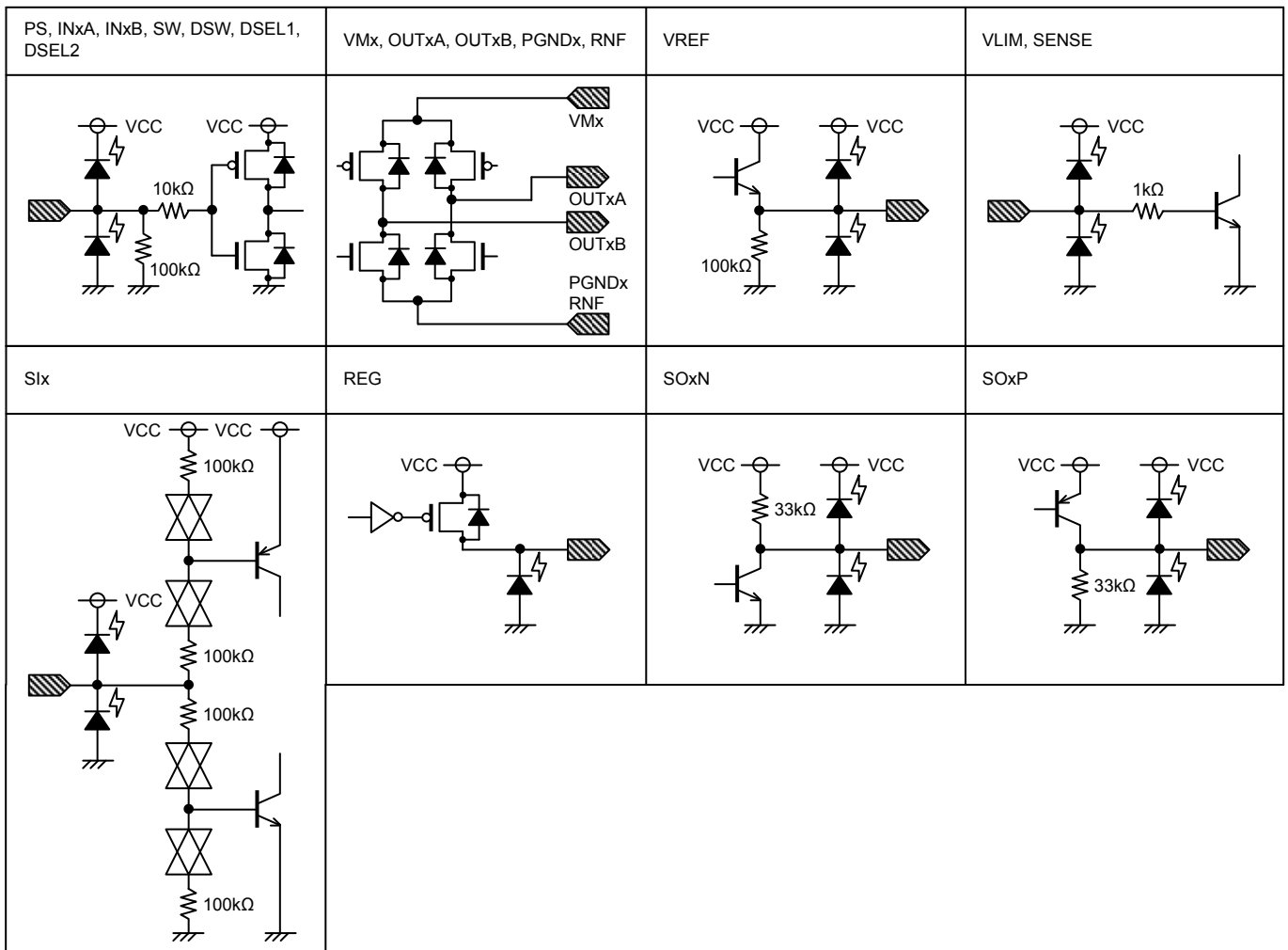

Fig.19 BD6889GU I/O Circuit Diagram (Resistance values are typical ones)

●Heat Dissipation

1) Power Consumption

The power consumption of the IC (Pw) is expressed by the following formula.

$$Pw[W] = VCC[V] \times ICC[A] + Iout^2[A^2] \times RON[\Omega] \text{ (Full-ON Drive block and PWM Constant-Current Drive block)} \dots\dots(2)$$

$$= VCC[V] \times ICC[A] + Iout[A] \times (VM[V] - VRNF[V] - Iout[A] \times Rm[\Omega]) \text{ (Linear Constant-Current Drive block)} \dots\dots(3)$$

- Pw: Power consumption of the IC
- VCC: Power supply voltage on the VCC pin
- ICC: Current consumption of the VCC pin
- Iout: Current consumption of the VM pin on the drive channel
- RON: Total ON-Resistance on the high and low drive channel
- VM: Power supply voltage on the VM pin on the drive channel
- VRNF: Voltage on the RNF pin on the drive channel
- Rm: Resistance on the motor on the drive channel

While in operation, check that the junction temperature (Tjmax) of the IC will not be in excess of 150°C, in consideration of formula (2), formula (3), the package power (Pd), and ambient temperature (Ta). If the junction temperature exceeds 150°C, the IC will not work as a properly. This can cause problems, such as parasitic oscillation and temperature leakage. If the IC is used under such conditions, it will result in characteristic degradation and eventually fail. Be sure to keep the junction temperature lower than 150°C.

2) Measurement Method of Junction Temperature

The junction temperature can be measured by the following method.

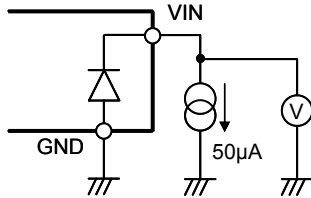

Fig.20 Tjmax Measurement Circuit Diagram

By using the diode temperature characteristics of the control input pin, on a channel that is not driven, the junction temperature X can be measured in a pseudo manner.

The junction temperature X[°C] under certain conditions is expressed by formula (4), provided that the temperature characteristic of the diode is -2 mV/°C

$$X[°C] = \frac{a - b[mV]}{-2 [mV/°C]} + 25[°C] \dots\dots(4)$$

- X: Junction temperature
- a: The voltmeter V value at a junction temperature of 25°C
- b: The voltmeter V value at a junction temperature of X°C
- 2: Temperature characteristic of diode

If the exact junction temperature is desired, it is necessary to measure the specific temperature characteristic of the internal diode, of each IC.

●Notes for use

1) Absolute maximum ratings

Use of the IC in excess of absolute maximum ratings such as the applied voltage or operating temperature range may result in IC damage. Assumptions should not be made regarding the state of the IC (short mode or open mode) when such damage is suffered. The implementation of a physical safety measure such as a fuse should be considered when use of the IC in a special mode where the absolute maximum ratings may be exceeded is anticipated.

2) Storage temperature range

As long as the IC is kept within this range, there should be no problems in the IC's performance. Conversely, extreme temperature changes may result in poor IC performance, even if the changes are within the above range.

3) Power supply pins and lines

None of the VM line for the H-bridges is internally connected to the VCC power supply line, which is only for the control logic or analog circuit. Therefore, the VM and VCC lines can be driven at different voltages. Although these lines can be connected to a common power supply, do not open the power supply pin but connect it to the power supply externally. Regenerated current may flow as a result of the motor's back electromotive force. Insert capacitors between the power supply and ground pins to serve as a route for regenerated current. Determine the capacitance in full consideration of all the characteristics of the electrolytic capacitor, because the electrolytic capacitor may lose some capacitance at low temperatures. If the connected power supply does not have sufficient current absorption capacity, regenerative current will cause the voltage on the power supply line to rise, which combined with the product and its peripheral circuitry may exceed the absolute maximum ratings. It is recommended to implement a physical safety measure such as the insertion of a voltage clamp diode between the power supply and ground pins.

For this IC with several power supplies and a part consists of the CMOS block, it is possible that rush current may flow instantaneously due to the internal powering sequence and delays, and to the unstable internal logic, respectively. Therefore, give special consideration to power coupling capacitance, width of power and ground wirings, and routing of wiring.

4) Ground pins and lines

Ensure a minimum GND pin potential in all operating conditions. Make sure that no pins are at a voltage below the GND at any time, regardless of whether it is a transient signal or not.

When using both small signal GND and large current MGND patterns, it is recommended to isolate the two ground patterns, placing a single ground point at the application's reference point so that the pattern wiring resistance and voltage variations caused by large currents do not cause variations in the small signal ground voltage. Be careful not to change the GND wiring pattern of any external components, either.

The power supply and ground lines must be as short and thick as possible to reduce line impedance.

5) Thermal design

Use a thermal design that allows for a sufficient margin in light of the power dissipation (P_d) in actual operating conditions.

6) Pin short and wrong direction assembly of the device

Use caution when positioning the IC for mounting on printed circuit boards. The IC may be damaged if there is any connection error or if positive and ground power supply terminals are reversed. The IC may also be damaged if pins are shorted together or are shorted to other circuit's power lines.

7) Actions in strong magnetic field

Use caution when using the IC in the presence of a strong magnetic field as doing so may cause the IC to malfunction.

8) ASO

When using the IC, set the output transistor for the motor so that it does not exceed absolute maximum ratings or ASO.

9) Thermal shutdown circuit

If the junction temperature (T_{jmax}) reaches 175°C , the TSD circuit will operate, and the coil output circuit of the motor will open. There is a temperature hysteresis of approximately 20°C (BD6757KN Typ.) and 25°C (BD6889GU Typ.). The TSD circuit is designed only to shut off the IC in order to prevent runaway thermal operation. It is not designed to protect the IC or guarantee its operation. The performance of the IC's characteristics is not guaranteed and it is recommended that the device is replaced after the TSD is activated.

10) Testing on application board

When testing the IC on an application board, connecting a capacitor to a pin with low impedance subjects the IC to stress. Always discharge capacitors after each process or step. Always turn the IC's power supply off before connecting it to, or removing it from a jig or fixture, during the inspection process. Ground the IC during assembly steps as an antistatic measure. Use similar precaution when transporting and storing the IC.

11) Application example

The application circuit is recommended for use. Make sure to confirm the adequacy of the characteristics. When using the circuit with changes to the external circuit constants, make sure to leave an adequate margin for external components including static and transitional characteristics as well as dispersion of the IC.

12) Regarding input pin of the IC

This monolithic IC contains P^+ isolation and P substrate layers between adjacent elements to keep them isolated. P-N junctions are formed at the intersection of these P layers with the N layers of other elements, creating a parasitic diode or transistor. For example, the relation between each potential is as follows:

When $\text{GND} > \text{Pin A}$, the P-N junction operates as a parasitic diode.

When $\text{GND} > \text{Pin B}$, the P-N junction operates as a parasitic diode and transistor.

Parasitic elements can occur inevitably in the structure of the IC. The operation of parasitic elements can result in mutual interference among circuits, operational faults, or physical damage. Accordingly, methods by which parasitic elements operate, such as applying a voltage that is lower than the GND (P substrate) voltage to an input pin, should not be used.

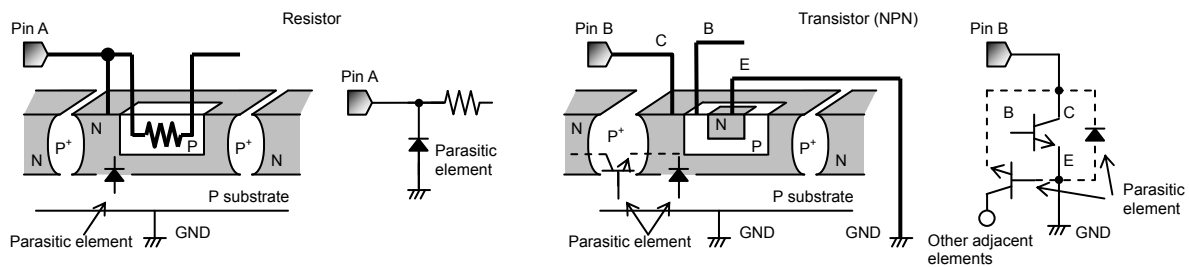

Fig.21 Example of Simple IC Architecture

● Ordering part number

B	D
---	---

Part No.

6	7	5	7
---	---	---	---

Part No.
 6757 : Wide power supply voltage range
 6889 : Subminiature package

K	N
---	---

Package
 KN : UQFN52
 GU : VBGA063T050

E	2
---	---

Packaging and forming specification
 E2: Embossed tape and reel

UQFN52

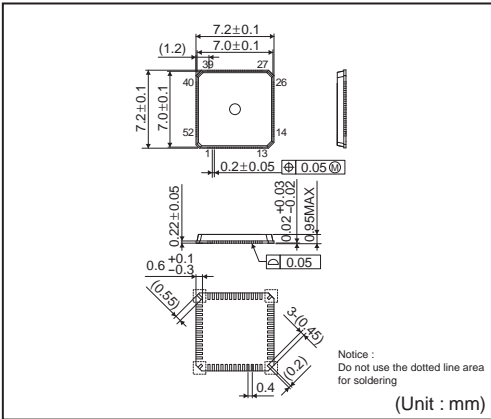

<Tape and Reel information>

Tape	Embossed carrier tape (with dry pack)
Quantity	2500pcs
Direction of feed	E2 (The direction is the 1pin of product is at the upper left when you hold reel on the left hand and you pull out the tape on the right hand)

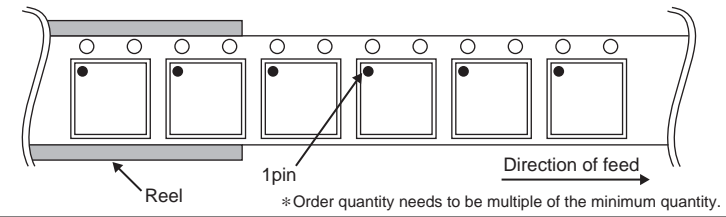

VBGA063T050

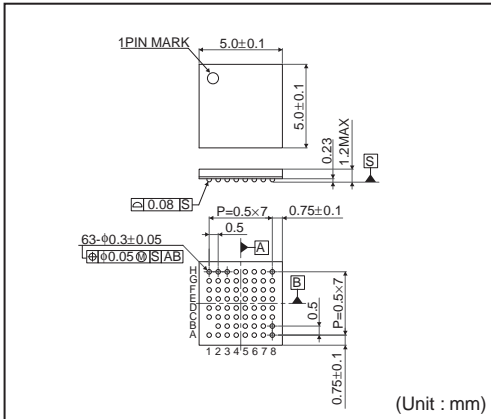

<Tape and Reel information>

Tape	Embossed carrier tape (with dry pack)
Quantity	2500pcs
Direction of feed	E2 (The direction is the 1pin of product is at the upper left when you hold reel on the left hand and you pull out the tape on the right hand)

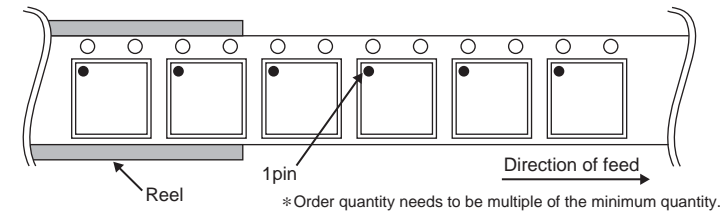

Notes

No copying or reproduction of this document, in part or in whole, is permitted without the consent of ROHM Co.,Ltd.

The content specified herein is subject to change for improvement without notice.

The content specified herein is for the purpose of introducing ROHM's products (hereinafter "Products"). If you wish to use any such Product, please be sure to refer to the specifications, which can be obtained from ROHM upon request.

Examples of application circuits, circuit constants and any other information contained herein illustrate the standard usage and operations of the Products. The peripheral conditions must be taken into account when designing circuits for mass production.

Great care was taken in ensuring the accuracy of the information specified in this document. However, should you incur any damage arising from any inaccuracy or misprint of such information, ROHM shall bear no responsibility for such damage.

The technical information specified herein is intended only to show the typical functions of and examples of application circuits for the Products. ROHM does not grant you, explicitly or implicitly, any license to use or exercise intellectual property or other rights held by ROHM and other parties. ROHM shall bear no responsibility whatsoever for any dispute arising from the use of such technical information.

The Products specified in this document are intended to be used with general-use electronic equipment or devices (such as audio visual equipment, office-automation equipment, communication devices, electronic appliances and amusement devices).

The Products specified in this document are not designed to be radiation tolerant.

While ROHM always makes efforts to enhance the quality and reliability of its Products, a Product may fail or malfunction for a variety of reasons.

Please be sure to implement in your equipment using the Products safety measures to guard against the possibility of physical injury, fire or any other damage caused in the event of the failure of any Product, such as derating, redundancy, fire control and fail-safe designs. ROHM shall bear no responsibility whatsoever for your use of any Product outside of the prescribed scope or not in accordance with the instruction manual.

The Products are not designed or manufactured to be used with any equipment, device or system which requires an extremely high level of reliability the failure or malfunction of which may result in a direct threat to human life or create a risk of human injury (such as a medical instrument, transportation equipment, aerospace machinery, nuclear-reactor controller, fuel-controller or other safety device). ROHM shall bear no responsibility in any way for use of any of the Products for the above special purposes. If a Product is intended to be used for any such special purpose, please contact a ROHM sales representative before purchasing.

If you intend to export or ship overseas any Product or technology specified herein that may be controlled under the Foreign Exchange and the Foreign Trade Law, you will be required to obtain a license or permit under the Law.



Thank you for your accessing to ROHM product informations.
More detail product informations and catalogs are available, please contact us.

ROHM Customer Support System

<http://www.rohm.com/contact/>