

1-Input/4-Output Video Distribution Amplifiers

General Description

The MAX4137/MAX4138 are 1-input/4-output voltage-feedback amplifiers that combine high speed with fast switching for video distribution applications. The MAX4137 is internally set for a closed-loop gain of 2V/V, while the MAX4138 can be externally set for gains of 2V/V or greater.

The MAX4137 achieves a -3dB bandwidth of 185MHz, with 0.1dB gain flatness to 40MHz. The MAX4138's -3dB bandwidth is 140MHz, with 0.1dB gain flatness to 40MHz. Both devices deliver a 1000V/ μ s slew rate, as well as exceptional full-power bandwidths of 185MHz and 140MHz, respectively.

A 25ns channel switching time enables rapid multiplexing for picture-in-picture applications, yet maintains a high off-isolation of 75dB and all-hostile crosstalk of -50dB ($f = 30$ MHz). The MAX4137/MAX4138's on-board logic selects any combination of the four signal outputs. Each output is capable of swinging ± 2 V and delivering up to 65mA of current.

For applications that require a 1-input/6-output distribution amplifier, see the MAX4135/MAX4136 data sheet.

Selector Guide

PART	NO. OF OUTPUTS	GAIN (V/V)	-3dB BANDWIDTH (MHz)
MAX4135	6	Fixed 2	185
MAX4136	6	≥ 2	140
MAX4137	4	Fixed 2	185
MAX4138	4	≥ 2	140

Applications

- Video Switching and Distribution
- High-Resolution RGB CRT Monitors
- High-Speed Analog Bus Drivers
- RF Signal Processing
- Composite Video Preamplifiers

Features

- ◆ Fixed Gain of 2V/V (MAX4137)
External Gain Set (MAX4138)
- ◆ High Speed:
 - 185MHz -3dB Bandwidth (MAX4137)
 - 140MHz -3dB Bandwidth (MAX4138)
 - 1000V/ μ s Slew Rate
- ◆ High Full-Power Bandwidths ($V_{OUT} = 2V_{p-p}$):
 - 185MHz (MAX4137)
 - 140MHz (MAX4138)
- ◆ 0.1dB Gain Flatness to 40MHz
- ◆ Low Differential Gain/Phase Error: 0.10%/0.02°
- ◆ High-Impedance Output Disable

Ordering Information

PART	TEMP. RANGE	PIN-PACKAGE
MAX4137EWG	-40°C to +85°C	24 Wide SO
MAX4138EWG	-40°C to +85°C	24 Wide SO

Pin Configuration

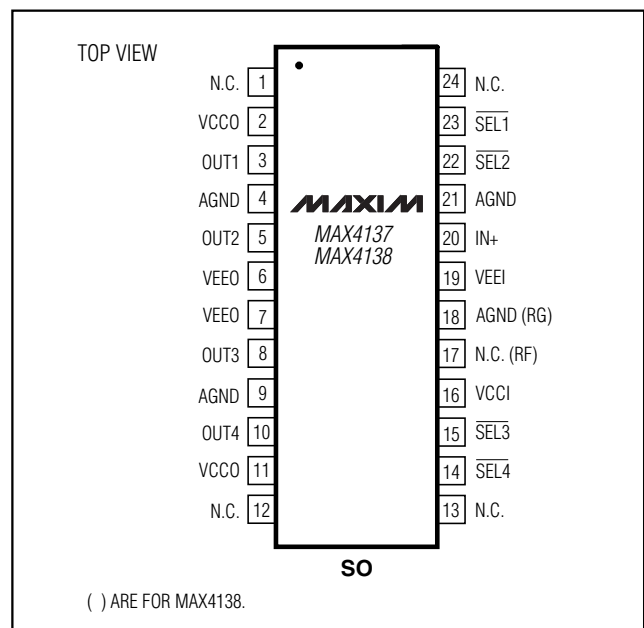

1-Input/4-Output Video Distribution Amplifiers

ABSOLUTE MAXIMUM RATINGS

Power-Supply Voltage (V_{CC} to V_{EE}) 12V
 Voltage on Any Input Pin to GND ($V_{CC} + 0.3V$) to ($V_{EE} - 0.3V$)
 Short-Circuit Duration to GND Continuous
 Continuous Power Dissipation ($T_A = +70^\circ\text{C}$)
 Wide SO (derate 19.3mW/ $^\circ\text{C}$ above $+70^\circ\text{C}$) 1.54W

Operating Temperature Range
 MAX4137EWG/MAX4138EWG -40°C to $+85^\circ\text{C}$
 Storage Temperature Range -65°C to $+160^\circ\text{C}$
 Lead Temperature (soldering, 10s) $+300^\circ\text{C}$

Stresses beyond those listed under "Absolute Maximum Ratings" may cause permanent damage to the device. These are stress ratings only, and functional operation of the device at these or any other conditions beyond those indicated in the operational sections of the specifications is not implied. Exposure to absolute maximum rating conditions for extended periods may affect device reliability.

DC ELECTRICAL CHARACTERISTICS

($V_{CC} = +5V$, $V_{EE} = -5V$, $T_A = T_{MIN}$ to T_{MAX} , unless otherwise noted. Typical values are at $T_A = +25^\circ\text{C}$.)

PARAMETER	SYMBOL	CONDITIONS	MIN	TYP	MAX	UNITS
Input Offset Voltage	V_{OS}	$V_{OUT} = 0V$, $R_L = 150\Omega$		1	10	mV
Input Offset Voltage Match Between Channels		$V_{OUT} = 0V$, $R_L = 150\Omega$		1	8	mV
Input Offset Voltage Drift	TCV_{OS}	$V_{OUT} = 0V$, $R_L = \infty$		30		$\mu\text{V}/^\circ\text{C}$
Input Bias Current	I_B	$V_{OUT} = 0V$, $R_L = \infty$, $V_{IN} = -V_{OS}$		4.5	13	μA
Common-Mode Input Resistance	$R_{IN(CM)}$	MAX4138, either input		5		$M\Omega$
Common-Mode Input Capacitance	$C_{IN(CM)}$	MAX4138, either input		2		pF
Input Voltage Noise	e_n	$f = 1\text{MHz}$		7		$\text{nV}/\sqrt{\text{Hz}}$
		$f = 1\text{MHz to } 100\text{MHz}$		88		μVRMS
Input Current Noise	i_n	$f = 1\text{MHz}$		2.4		$\text{pA}/\sqrt{\text{Hz}}$
		$f = 1\text{MHz to } 100\text{MHz}$		30		nARMS
Input Capacitance	C_{IN}			2		pF
Common-Mode Input Voltage Range	V_{CM}			± 2.5		V
Common-Mode Rejection Ratio	CMRR	$V_{CM} = \pm 2.5V$		60		dB
Power-Supply Rejection Ratio	PSRR	$V_S = \pm 4.75V$ to $\pm 5.25V$	55	65		dB
Quiescent Supply Current	I_{SY}	$V_{IN} = 0V$	All channels off	30	48	mA
			All channels on	47	70	
Output Voltage Swing	V_{OUT}	$R_L = 150\Omega$	Positive	2.2	2.6	V
			Negative	-2.0	-2.5	
Output Current Drive	I_{OUT}	$R_L = 30\Omega$	45	65		mA
$\overline{\text{SEL}}$ High Threshold	V_{IH}				2.0	V
$\overline{\text{SEL}}$ Low Threshold	V_{IL}		0.8			V
$\overline{\text{SEL}}$ Input Current	I_{SEL}			1	5	μA

1-Input/4-Output Video Distribution Amplifiers

MAX4137/MAX4138

AC ELECTRICAL CHARACTERISTICS

(VCC = +5V, VEE = -5V, AvCL = 2V/V, TA = TMIN to TMAX, unless otherwise noted. Typical values are at TA = 25°C.)

PARAMETER	SYMBOL	CONDITIONS		MIN	TYP	MAX	UNITS
-3dB Bandwidth	BW-3dB	VOUT ≤ 0.1VRMS, AvCL = 2V/V	MAX4137		185		MHz
			MAX4138		140		
Full-Power Bandwidth	FPBW	VOUT = 2Vp-p, AvCL = 2V/V	MAX4137		185		MHz
			MAX4138		140		
0.1dB Bandwidth		AvCL = 2V/V			40		MHz
Slew Rate	SR	-2V ≤ VOUT ≤ +2V			1000		V/μs
Settling Time	ts	-1V ≤ VOUT ≤ +1V, RL = 150Ω, AvCL = 2V/V	to 0.1%		17		ns
			to 0.01%		40		
Differential Gain	DG	f = 3.58MHz, AvCL = 2V/V	MAX4137		0.10		%
			MAX4138		0.10		
Differential Phase	DP	f = 3.58MHz, AvCL = 2V/V	MAX4137		0.02		degrees
			MAX4138		0.02		
All-Hostile Crosstalk		VIN = 1Vp-p, f = 30MHz			-50		dB
Off Isolation		VIN = 1Vp-p, f = 30MHz			75		dB
Channel Switching Off Time	tOFF				25		ns
Channel Switching On Time	ton				25		ns
Digital Switching Feedthrough		VIN = 0VDC			±1		mV
Spurious-Free Dynamic Range	SFDR	fc = 5MHz, AvCL = 2V/V, VOUT = 2Vp-p, RL = 100Ω			-72		dBc
Output On-Resistance	ROUT	f = DC, AvCL = 2V/V			1		Ω
Output Off-Resistance	ROUT	f = DC, AvCL = 2V/V			200		kΩ
Output On-Capacitance	COUT(ON)				2		pF
Output Off-Capacitance	COUT(OFF)				3.5		pF

1-Input/4-Output Video Distribution Amplifiers

Typical Operating Characteristics

($V_{CC} = +5V$, $V_{EE} = -5V$, $R_L = 150\Omega$, $T_A = +25^\circ C$, unless otherwise noted.)

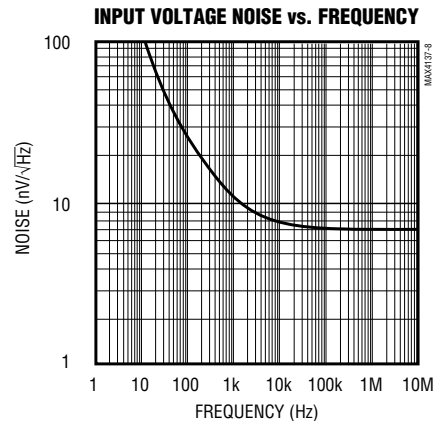
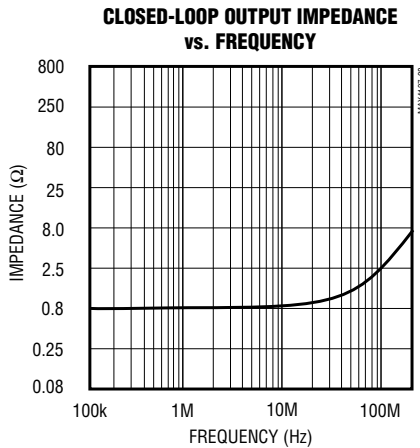
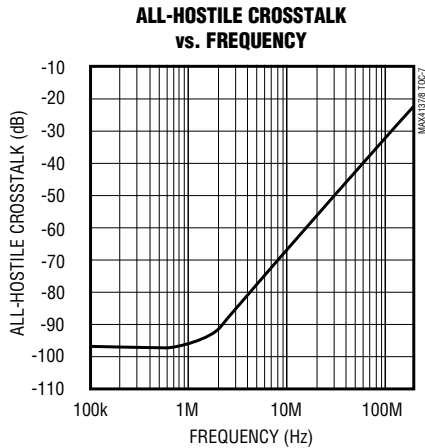
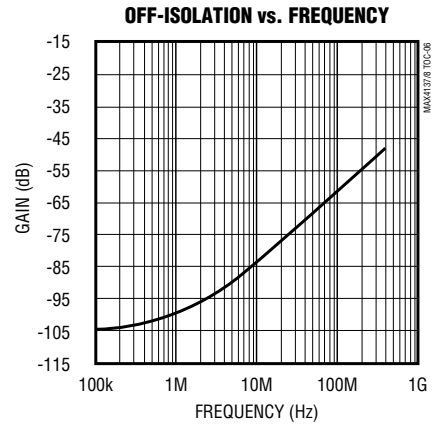
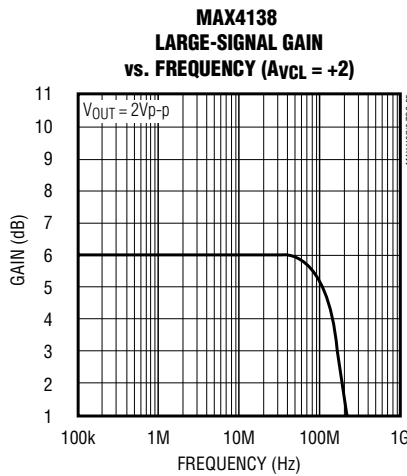
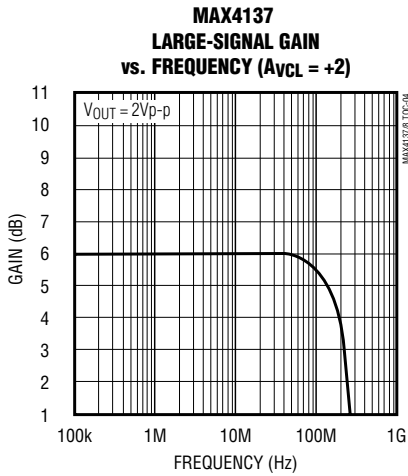
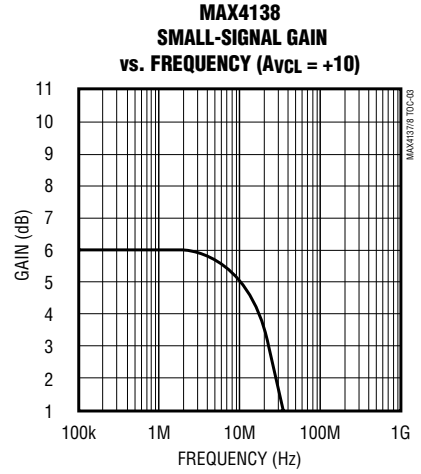
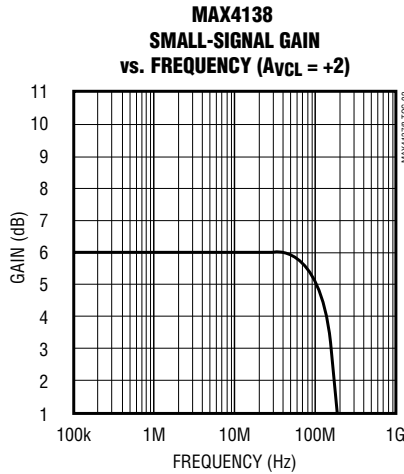
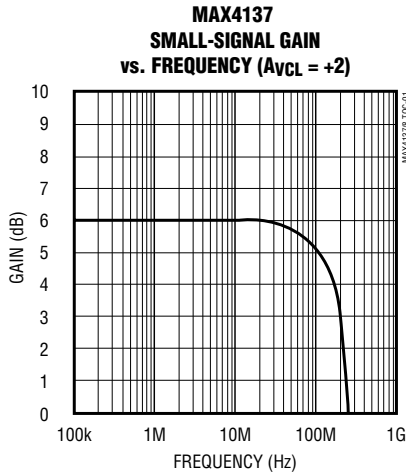

1-Input/4-Output Video Distribution Amplifiers

Typical Operating Characteristics (continued)

($V_{CC} = +5V$, $V_{EE} = -5V$, $R_L = 150\Omega$, $T_A = +25^\circ C$, unless otherwise noted.)

MAX4137/MAX4138

MAX4137
LARGE-SIGNAL PULSE RESPONSE
($A_{VCL} = +2$)

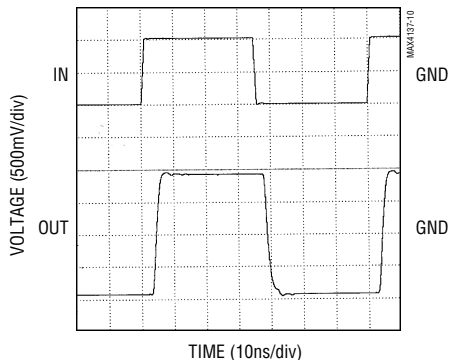

MAX4138
LARGE-SIGNAL PULSE RESPONSE
($A_{VCL} = +2$)

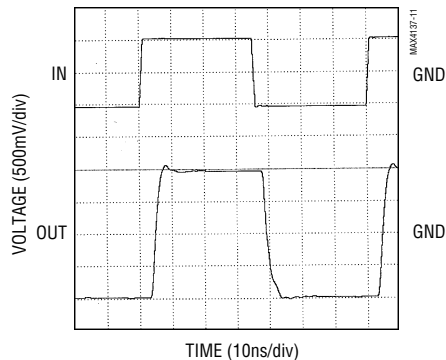

MAX4137
SMALL-SIGNAL PULSE RESPONSE
($A_{VCL} = +2$)

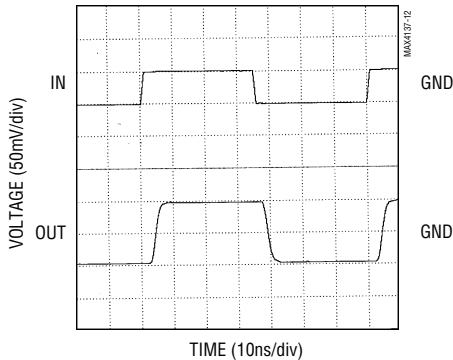

MAX4138
SMALL-SIGNAL PULSE RESPONSE
($A_{VCL} = +2$)

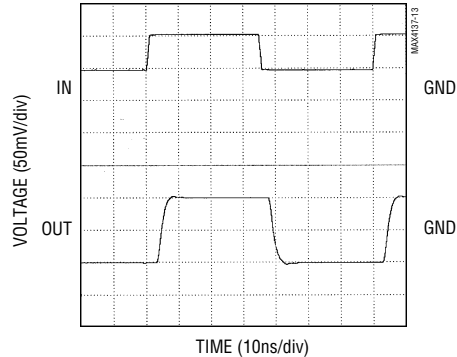

DIGITAL FEEDTHROUGH

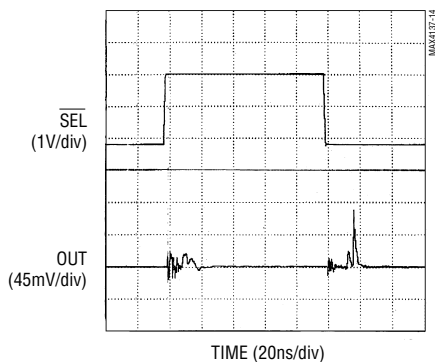

1-Input/4-Output Video Distribution Amplifiers

Typical Operating Characteristics (continued)

($V_{CC} = +5V$, $V_{EE} = -5V$, $R_L = 150\Omega$, $T_A = +25^\circ C$, unless otherwise noted.)

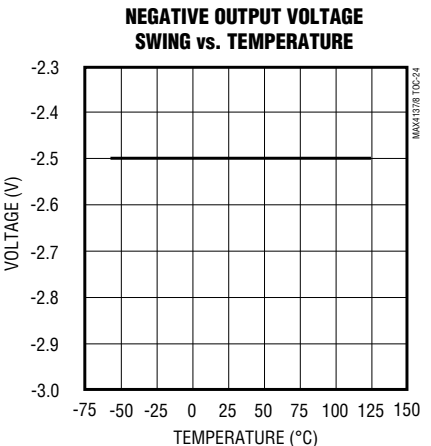
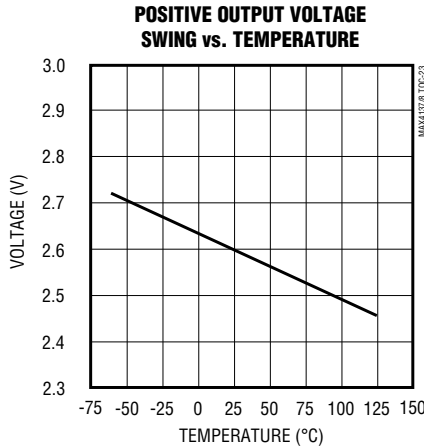
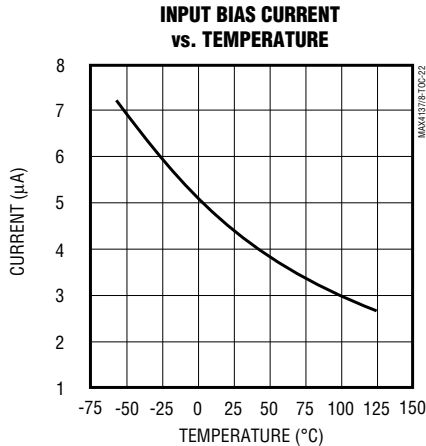
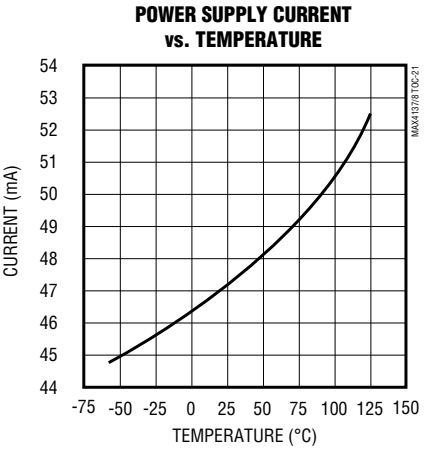
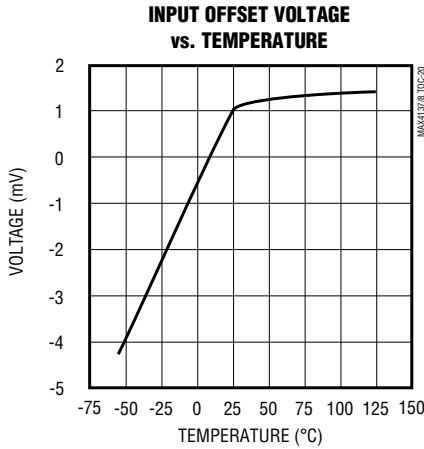
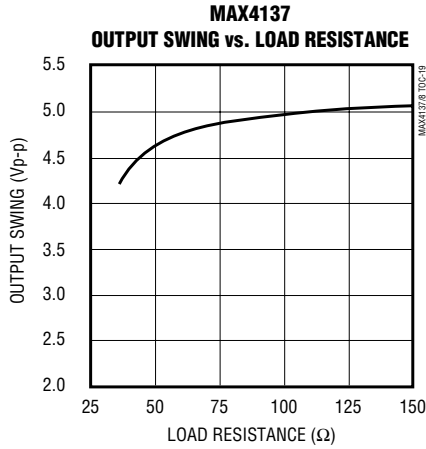
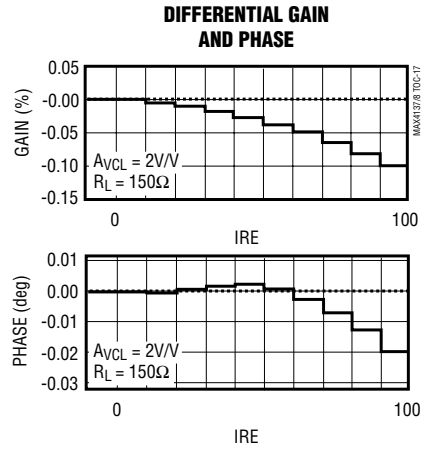
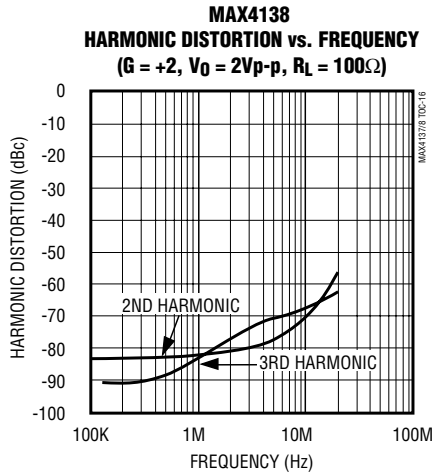
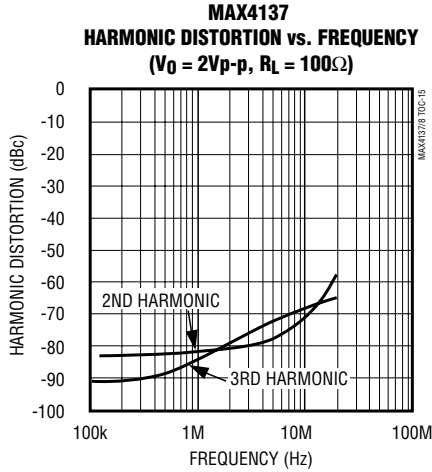

1-Input/4-Output Video Distribution Amplifiers

Pin Description

MAX4137/MAX4138

PIN		NAME	FUNCTION
MAX4137	MAX4138		
1, 12, 13, 17, 24	1, 12, 13, 24	N.C.	No Connect. Not internally connected.
2, 11	2, 11	VCCO	Positive Supply for Output Amplifiers. Connect to +5V.
3	3	OUT1	Output 1
4, 9, 18, 21	4, 9, 21	AGND	Analog Ground
5	5	OUT2	Output 2
6, 7	6, 7	VEEO	Negative Supply for Output Amplifiers. Connect to -5V.
8	8	OUT3	Output 3
10	10	OUT4	Output 4
14	14	$\overline{\text{SEL}}_4$	When low, enables output channel OUT4. When high, disables output channel OUT4.
15	15	$\overline{\text{SEL}}_3$	When low, enables output channel OUT3. When high, disables output channel OUT3.
16	16	VCCI	Positive Supply for Input Amplifier. Connect to +5V.
—	17	RF	Output of Input Amplifier
—	18	RG	Inverting Input
19	19	VEEI	Negative Supply for Input Amplifier. Connect to -5V.
20	20	IN+	Noninverting Input
22	22	$\overline{\text{SEL}}_2$	When low, enables output channel OUT2. When high, disables output channel OUT2.
23	23	$\overline{\text{SEL}}_1$	When low, enables output channel OUT1. When high, disables output channel OUT1.

Detailed Description

The MAX4137/MAX4138 are 1-input/4-output video distribution amplifiers. The MAX4137 is configured for a fixed gain of +2, while the MAX4138 features external gain control (feedback) for closed-loop gains of 2V/V or greater.

Each output provides sufficient current to drive five 150 Ω loads. However, distortion will increase when driving multiple loads. The TTL/CMOS-compatible digital control ($\overline{\text{SEL}}_n$) enables or disables each output amplifier. When the $\overline{\text{SEL}}_n$ control input is low, the amplifier is enabled; when it is high, the amplifier is disabled and presents a high-impedance output. The enable/disable or

disable/enable time is under 25ns, which is useful in multiplexing, pixel switching, or picture-in-picture applications.

Each device has an input amplifier, which buffers the input from any switching glitches that may be taking place at the output stage, and provides a high-impedance, low-capacitance input. The separate input buffer allows a true high output impedance when an amplifier is disabled.

The outputs are protected against short circuits to ground. However, power-dissipation limits preclude shorting all output channels to ground. See the *Power-Dissipation Considerations* section for details.

1-Input/4-Output Video Distribution Amplifiers

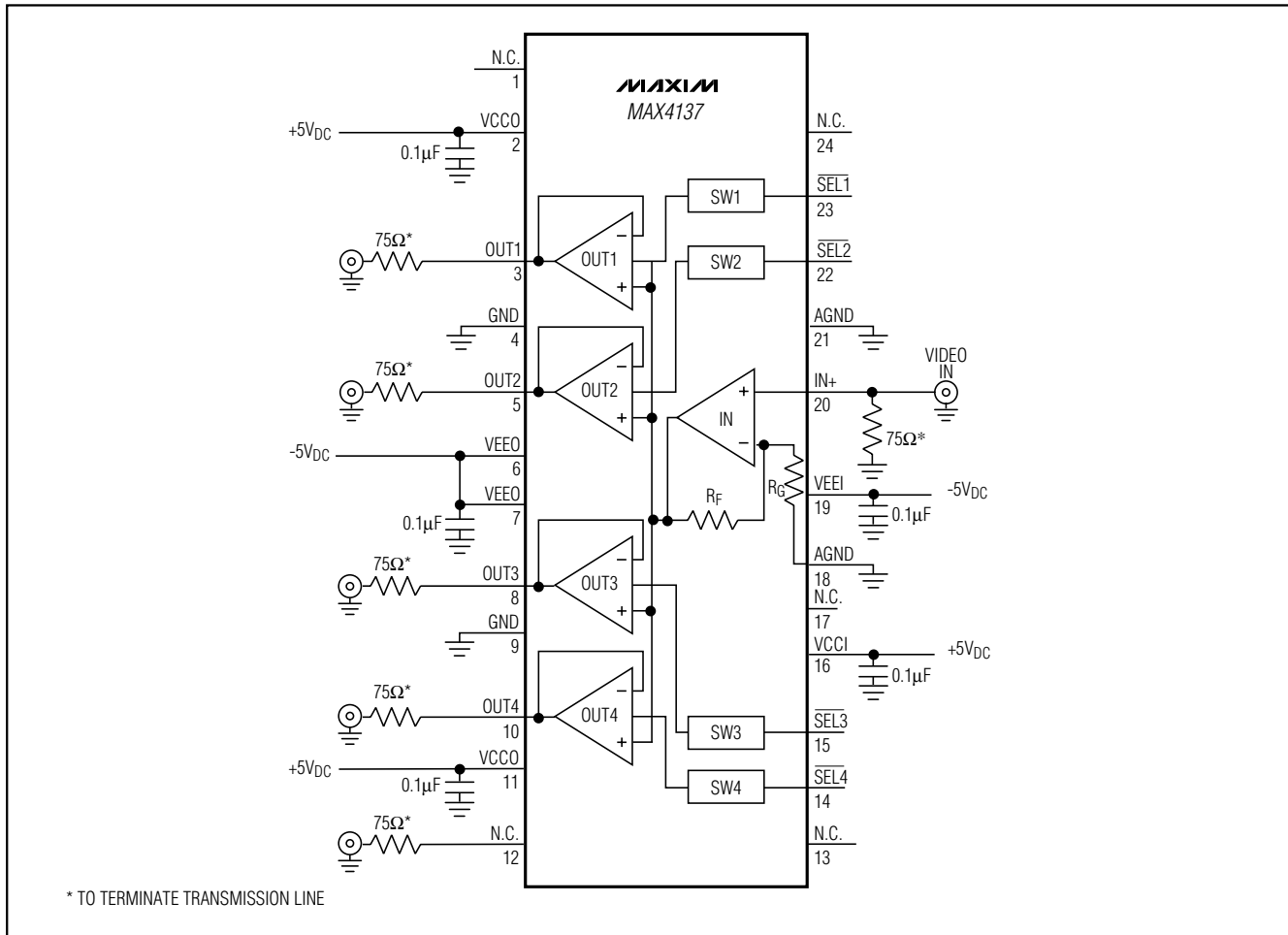

Figure 1. MAX4137 Typical Operating Circuit

Applications Information

Grounding, Bypassing, and PC Board Layout

To obtain the MAX4137/MAX4138s' full 185MHz bandwidth, Microstrip and Stripline techniques are recommended in most cases. To ensure the PC board does not degrade the amplifier's performance, design the board for a frequency greater than 1GHz. Even with very short traces, use these techniques at critical points, such as inputs and outputs. Whether you use a constant-impedance board or not, observe the following guidelines when designing the board:

- Do not use wire-wrap boards. They are too inductive.
- Do not use IC sockets. They increase parasitic capacitance and inductance.
- In general, surface-mount components have shorter leads and lower parasitic reactance, giving better high-frequency performance than through-hole components.
- The PC board should have at least two layers, with one side a signal layer and the other a ground plane.
- Keep signal lines as short and straight as possible. Do not make 90° turns; round all corners.
- The ground plane should be as free from voids as possible.

1-Input/4-Output Video Distribution Amplifiers

MAX4137/MAX4138

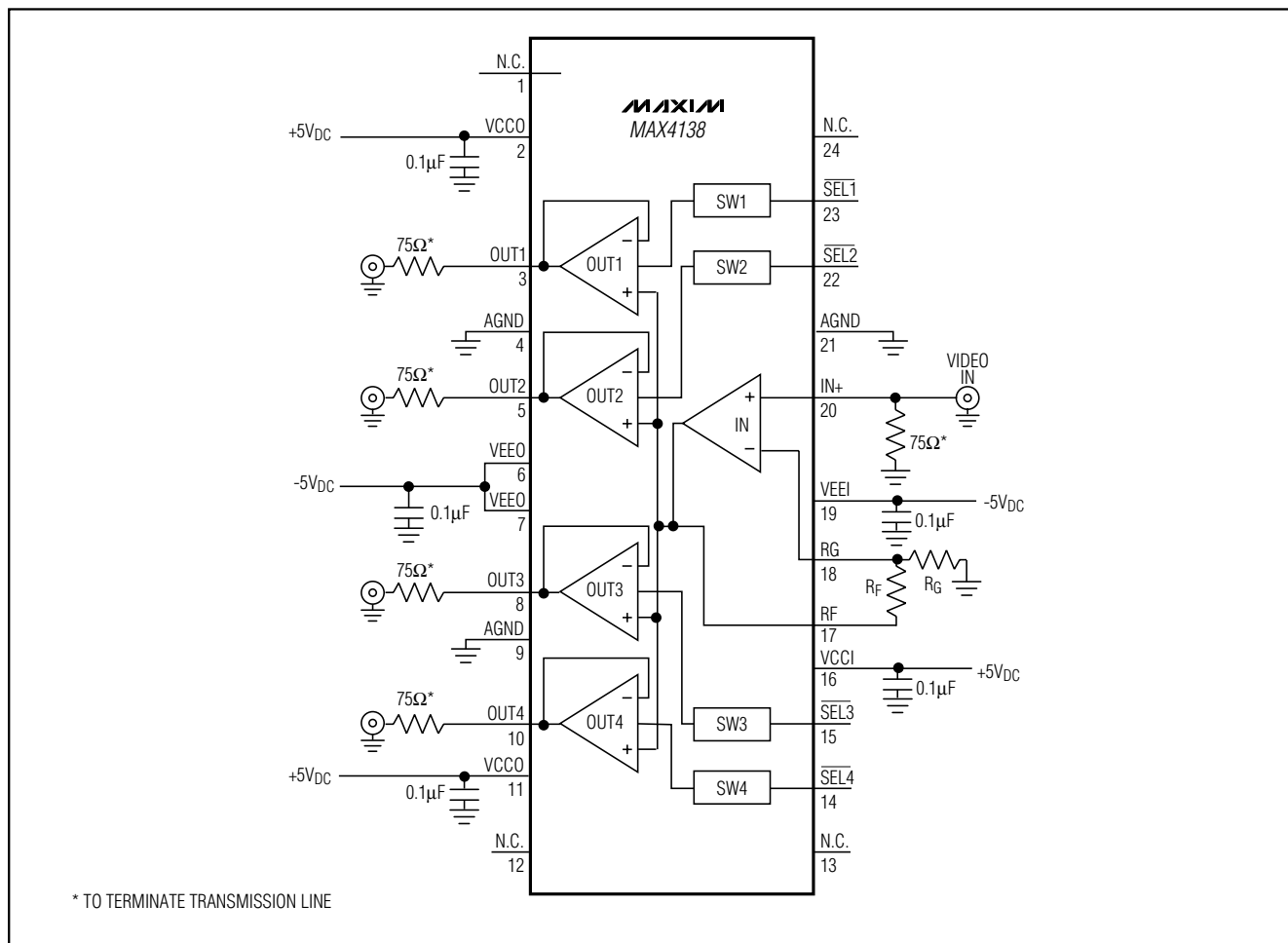

Figure 2. MAX4138 Typical Operating Circuit

Driving Capacitive Loads

The MAX4137/MAX4138 provide maximum AC performance with no output load capacitance. This is the case when they are driving a correctly terminated transmission line (i.e., a back-terminated 75Ω cable). However, the MAX4137/MAX4138 are capable of driving capacitive loads up to 10pF without oscillations, but with reduced AC performance.

Driving large capacitive loads increases the chance of oscillations in most amplifier circuits. This is especially true for circuits with high loop gain, such as voltage followers. The amplifier's output resistance and the load capacitor combine to add a pole and excess phase to

the loop response. If the frequency of this pole is low enough and phase margin is degraded sufficiently, oscillations may occur.

A second problem when driving capacitive loads results from the amplifier's output impedance, which looks inductive at high frequencies. This inductance forms an L-C resonant circuit with the capacitive load, which causes peaking in the frequency response and degrades the amplifier's gain margin.

The MAX4137/MAX4138 drive capacitive loads up to 10pF without oscillation. However, some peaking (in the frequency domain) or ringing (in the time domain) may occur (Figure 3).

1-Input/4-Output Video Distribution Amplifiers

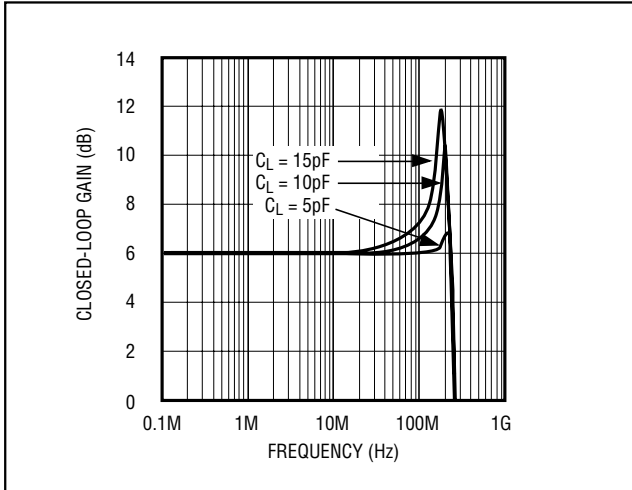

Figure 3. Effect of C_{LOAD} on Frequency Response (without R_{ISO})

To drive larger-capacitance loads or to reduce ringing, add an isolation resistor between the amplifier's output and the load, as shown in Figure 4.

The value of R_{ISO} depends on the circuit's gain and the capacitive load. Figure 5 shows the optional isolation resistor (R_{ISO}) vs. capacitive load (C_L). At the higher capacitor values, the bandwidth is dominated by the RC network, formed by R_{ISO} and C_L .

Power-Dissipation Considerations

The MAX4137/MAX4138 can drive up to four outputs simultaneously. Quiescent power dissipation is typically 520mW and 650mW maximum, respectively, with all channels enabled. The maximum package power dissipation is rated at 1540mW.

In a typical application, four outputs drive a standard video signal into a 150Ω load. The amount of power added to the quiescent dissipation is minimal and no special precautions are necessary.

However, each output driving the maximum 65mA into 30Ω will cause a power-dissipation increase of approximately 200mW. Therefore, you should not allow more than three outputs to deliver that load simultaneously. Similarly, one output shorted to ground will cause a power-dissipation increase of 650mW. Only one output can be shorted to ground without violating the package power rating.

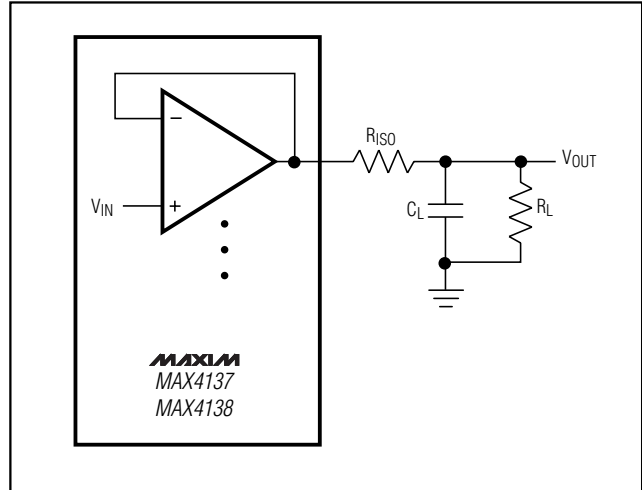

Figure 4. Capacitive-Load Driving Circuit

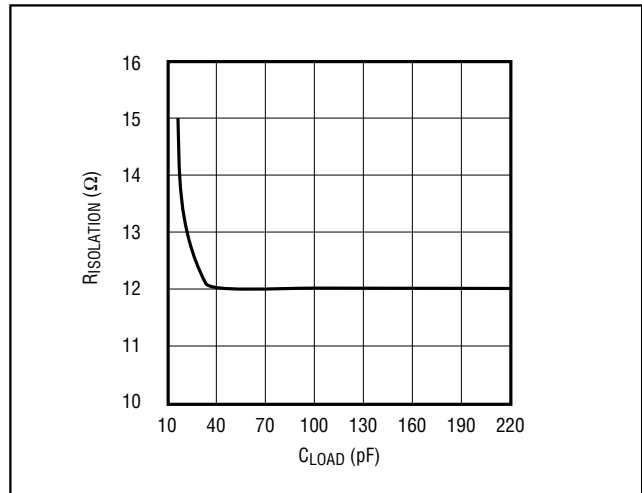

Figure 5. Optimal Isolation Resistor (R_{ISO}) vs. C_{LOAD}

In conclusion, during normal operation in a matched-load environment, the total power dissipation is well within the package's dissipation rating. The maximum power dissipation is violated only if multiple channels are driving the maximum current into minimum loads at the same time.

1-Input/4-Output Video Distribution Amplifiers

MAX4137/MAX4138

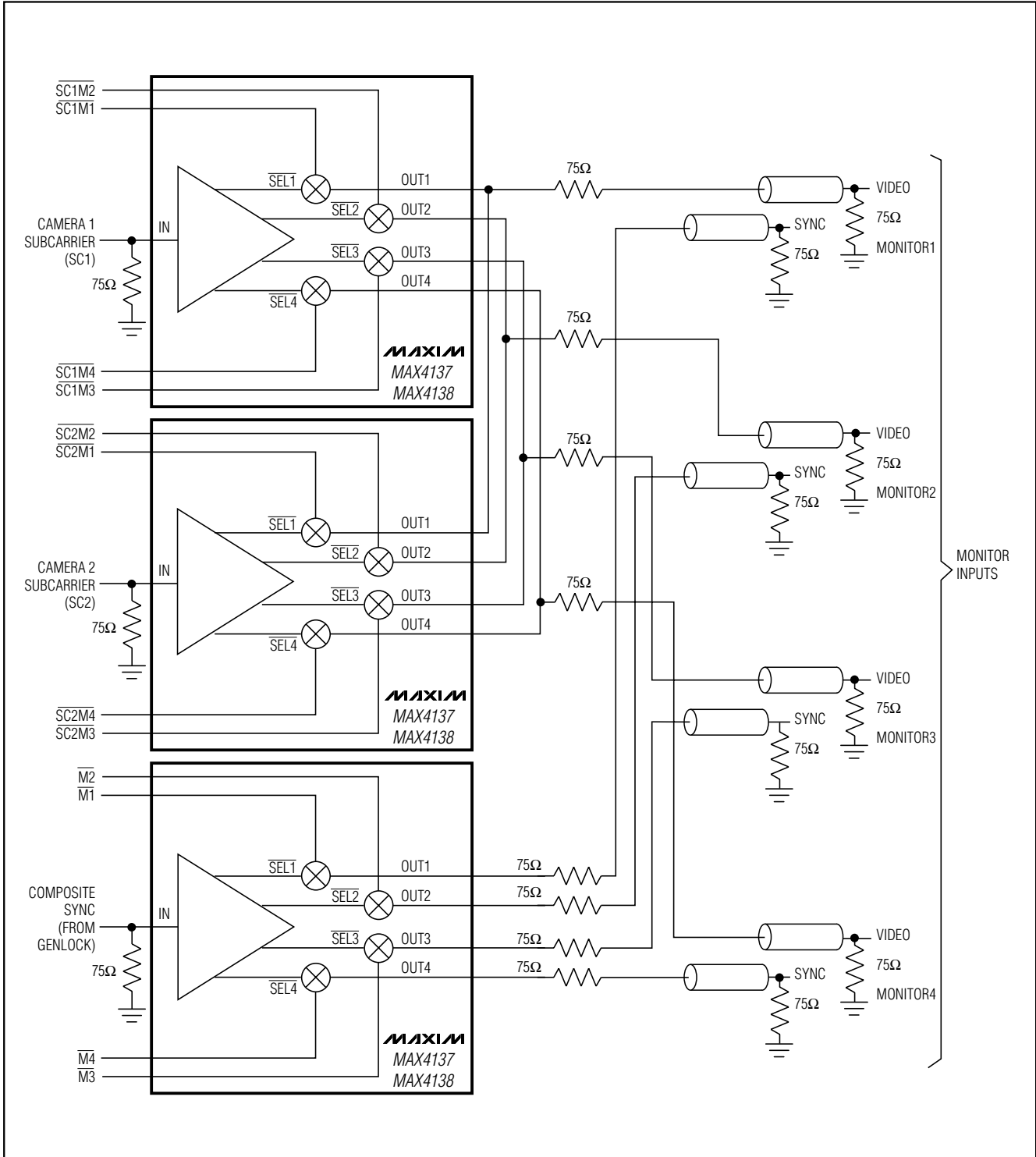

Figure 6. Two Cameras to Four Monitors Distribution Amplifier

1-Input/4-Output Video Distribution Amplifiers

Chip Information

TRANSISTOR COUNT: 625
SUBSTRATE CONNECTED TO V_{EE}

Package Information

DIM	INCHES		MILLIMETERS	
	MIN	MAX	MIN	MAX
A	0.093	0.104	2.35	2.65
A1	0.004	0.012	0.10	0.30
B	0.014	0.019	0.35	0.49
C	0.009	0.013	0.23	0.32
E	0.291	0.299	7.40	7.60
e	0.050		1.27	
H	0.394	0.419	10.00	10.65
L	0.016	0.050	0.40	1.27

DIM	PINS	INCHES		MILLIMETERS	
		MIN	MAX	MIN	MAX
D	16	0.398	0.413	10.10	10.50
D	18	0.447	0.463	11.35	11.75
D	20	0.496	0.512	12.60	13.00
D	24	0.598	0.614	15.20	15.60
D	28	0.697	0.713	17.70	18.10

**Wide SO
SMALL-OUTLINE
PACKAGE
(0.300 in.)**

21-0042A

Maxim cannot assume responsibility for use of any circuitry other than circuitry entirely embodied in a Maxim product. No circuit patent licenses are implied. Maxim reserves the right to change the circuitry and specifications without notice at any time.

12 **Maxim Integrated Products, 120 San Gabriel Drive, Sunnyvale, CA 94086 (408) 737-7600**