



BC556/557/558

PNP SILICON TRANSISTOR

SWITCHING AND AMPLIFIER APPLICATIONS

■ FEATURES

* High Voltage: BC556, $V_{CE0}=-65V$

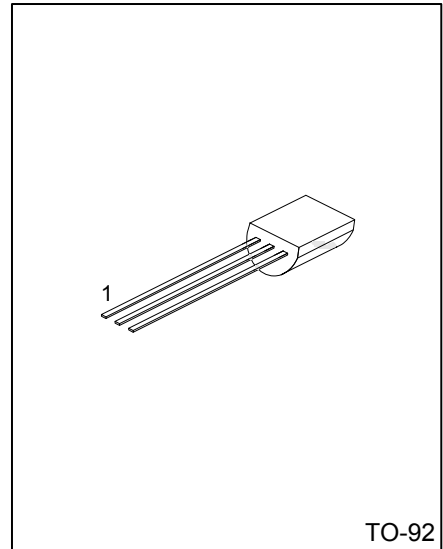

■ ORDERING INFORMATION

Ordering Number			Package	Pin Assignment			Packing
Normal	Lead Free Plating	Halogen Free		1	2	3	
BC556-x-T92-B	BC556L-x-T92-B	BC556G-x-T92-B	TO-92	C	B	E	Tape Box
BC556-x-T92-K	BC556L-x-T92-K	BC556G-x-T92-K	TO-92	C	B	E	Bulk
BC557-x-T92-B	BC557L-x-T92-B	BC557G-x-T92-B	TO-92	C	B	E	Tape Box
BC557-x-T92-K	BC557L-x-T92-K	BC557G-x-T92-K	TO-92	C	B	E	Bulk
BC558-x-T92-B	BC558L-x-T92-B	BC558G-x-T92-B	TO-92	C	B	E	Tape Box
BC558-x-T92-K	BC558L-x-T92-K	BC558G-x-T92-K	TO-92	C	B	E	Bulk

<p>BC556L-x-T92-B</p> <p>(1)Packing Type (2)Package Type (3)Rank (4)Lead Plating</p>	<p>(1) B: Tape Box, K: Bulk (2) T92: TO-92 (3) x: refer to Classification of h_{FE} (4) G: Halogen Free, L: Lead Free Plating, Blank: Pb/Sn</p>
--	--

BC556/557/558

PNP SILICON TRANSISTOR

■ ABSOLUTE MAXIMUM RATING (Ta=25°C, unless otherwise specified)

PARAMETER	SYMBOL	RATINGS	UNIT
Collector-Base Voltage	V _{CBO}	-80	V
		-50	V
		-30	V
Collector-Emitter Voltage	V _{CEO}	-65	V
		-45	V
		-30	V
Emitter-Base Voltage	V _{EBO}	-5	V
Collector Current (DC)	I _C	-100	mA
Power Collector Dissipation	P _C	625	mW
Linear Derating Factor above (Ta=25°C)		5	mW/°C
Junction Temperature	T _J	150	°C
Storage Temperature	T _{STG}	-55~+150	°C

Note: Absolute maximum ratings are those values beyond which the device could be permanently damaged. Absolute maximum ratings are stress ratings only and functional device operation is not implied.

■ THERMAL DATA

PARAMETER	SYMBOL	RATINGS	UNIT
Junction to Ambient	θ _{JA}	200	°C/W
Junction to Case	θ _{Jc}	83.3	°C/W

■ ELECTRICAL CHARACTERISTICS (Ta=25°C, unless otherwise specified)

PARAMETER	SYMBOL	TEST CONDITIONS	MIN	TYP	MAX	UNIT
Collector-Emitter Breakdown Voltage	BV _{CEO}	I _C =-10mA, I _B =0	-65			V
			-45			V
			-30			V
Collector-Base Breakdown Voltage	BV _{CBO}	I _C =-100μA	-80			V
			-50			V
			-30			V
Emitter-Base Breakdown Voltage	BV _{EBO}	I _E =-10μA, I _C =0	-5.0			V
Collector Cut-Off Current	I _{CBO}	I _E = 0, V _{CB} = -30 V			-15	nA
DC Current Gain	h _{FE}	V _{CE} = -5V, I _C =2mA	110		800	
Collector-Emitter Saturation Voltage	V _{CE(SAT)}	I _C = -10mA, I _B = -0.5mA		-90	-300	mV
		I _C = -100mA, I _B = -5mA		-250	-650	mV
Base-Emitter Saturation Voltage	V _{BE(SAT)}	I _C = -10mA, I _B = -0.5mA		-700		mV
		I _C = -100mA, I _B = -5mA		-900		mV
Base-Emitter Turn-On Voltage	V _{BE(ON)}	V _{CE} = -5 V, I _C = -2mA	-600	-660	-750	mV
		V _{CE} = -5 V, I _C = -10mA			-800	mV
Current Gain Bandwidth Product	f _T	V _{CE} = -5V, I _C = -10mA, f = 10MHz		150		MHz
Output Capacitance	C _{OB}	V _{CB} = -10V, I _E = 0, f = 1MHz			6	pF
Noise Figure	NF	V _{CE} = -5V, I _C = -200μA f = 1KHz, R _G = 2KΩ		2	10	dB

■ CLASSIFICATION OF h_{FE}

RANK	A	B	C
h _{FE}	110 - 220	200 - 450	420 - 800

TYPICAL CHARACTERISTICS

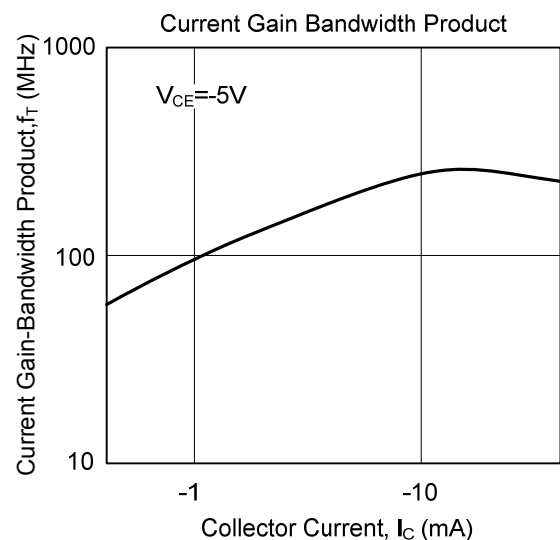
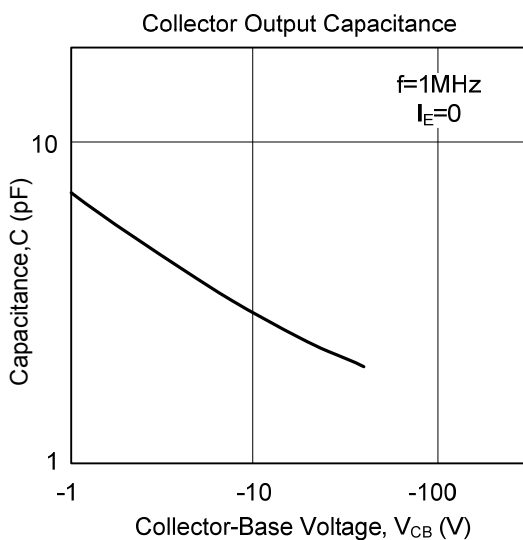
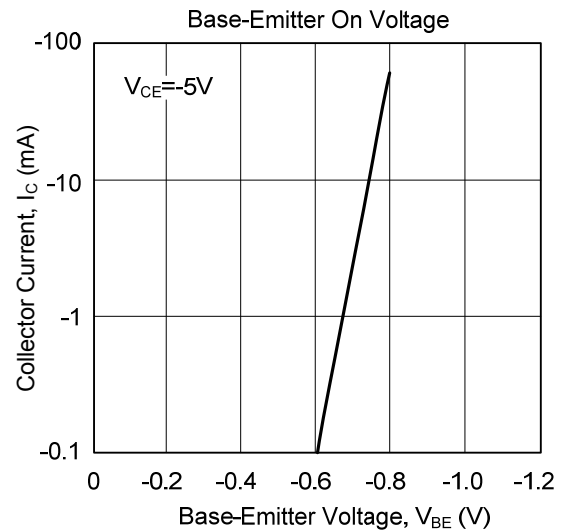
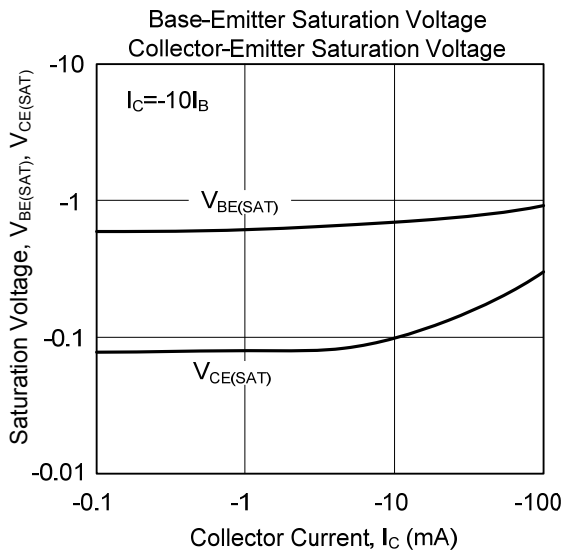
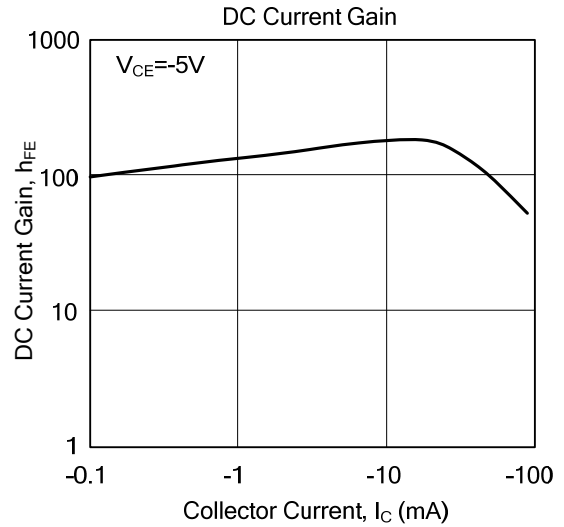
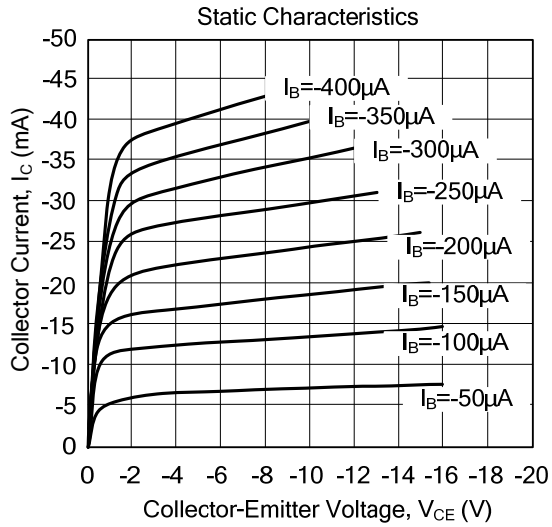

UTC assumes no responsibility for equipment failures that result from using products at values that exceed, even momentarily, rated values (such as maximum ratings, operating condition ranges, or other parameters) listed in products specifications of any and all UTC products described or contained herein. UTC products are not designed for use in life support appliances, devices or systems where malfunction of these products can be reasonably expected to result in personal injury. Reproduction in whole or in part is prohibited without the prior written consent of the copyright owner. The information presented in this document does not form part of any quotation or contract, is believed to be accurate and reliable and may be changed without notice.