

BC856BDW1T1G, BC857BDW1T1G Series, BC858CDW1T1G Series

Preferred Devices

Dual General Purpose Transistors

PNP Duals

These transistors are designed for general purpose amplifier applications. They are housed in the SOT-363/SC-88 which is designed for low power surface mount applications.

Features

- These Devices are Pb-Free, Halogen Free/BFR Free and are RoHS Compliant

MAXIMUM RATINGS

Rating	Symbol	Value	Unit
Collector - Emitter Voltage	V_{CEO}	-65 -45 -30	V
Collector - Base Voltage	V_{CBO}	-80 -50 -30	V
Emitter - Base Voltage	V_{EBO}	-5.0	V
Collector Current - Continuous	I_C	-100	mAdc

THERMAL CHARACTERISTICS

Characteristic	Symbol	Max	Unit
Total Device Dissipation Per Device FR-5 Board (Note 1) $T_A = 25^\circ\text{C}$ Derate Above 25°C	P_D	380 250	mW
Thermal Resistance, Junction-to-Ambient	$R_{\theta JA}$	328	$^\circ\text{C}/\text{W}$
Junction and Storage Temperature Range	T_J, T_{stg}	-55 to +150	$^\circ\text{C}$

Stresses exceeding Maximum Ratings may damage the device. Maximum Ratings are stress ratings only. Functional operation above the Recommended Operating Conditions is not implied. Extended exposure to stresses above the Recommended Operating Conditions may affect device reliability.

1. FR-5 = 1.0 x 0.75 x 0.062 in



ON Semiconductor®

<http://onsemi.com>

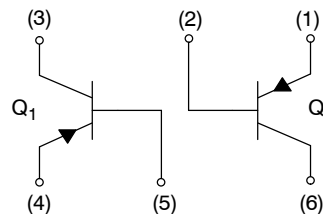

1

SOT-363/SC-88
CASE 419B
STYLE 1

MARKING DIAGRAM

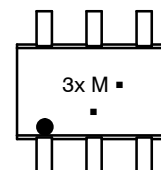

3x = Specific Device Code
x = B, F, G, or L
(See Ordering Information)
M = Date Code
■ = Pb-Free Package
(Note: Microdot may be in either location)

ORDERING INFORMATION

See detailed ordering and shipping information in the package dimensions section on page 5 of this data sheet.

Preferred devices are recommended choices for future use and best overall value.

BC856BDW1T1G, BC857BDW1T1G Series, BC858CDW1T1G Series

ELECTRICAL CHARACTERISTICS (T_A = 25°C unless otherwise noted)

Characteristic	Symbol	Min	Typ	Max	Unit	
OFF CHARACTERISTICS						
Collector – Emitter Breakdown Voltage (I _C = -10 mA)	BC856 Series BC857 Series BC858 Series	V _{(BR)CEO}	-65 -45 -30	-	-	V
Collector – Emitter Breakdown Voltage (I _C = -10 μA, V _{EB} = 0)	BC856 Series BC857B Only BC858 Series	V _{(BR)CES}	-80 -50 -30	-	-	V
Collector – Base Breakdown Voltage (I _C = -10 μA)	BC856 Series BC857 Series BC858 Series	V _{(BR)CBO}	-80 -50 -30	-	-	V
Emitter – Base Breakdown Voltage (I _E = -1.0 μA)	BC856 Series BC857 Series BC858 Series	V _{(BR)EBO}	-5.0 -5.0 -5.0	-	-	V
Collector Cutoff Current (V _{CB} = -30 V) (V _{CB} = -30 V, T _A = 150°C)		I _{CBO}	-	-	-15 -4.0	nA μA
ON CHARACTERISTICS						
DC Current Gain (I _C = -10 μA, V _{CE} = -5.0 V)	BC856B, BC857B BC857C, BC858C	h _{FE}	- -	150 270	- -	-
(I _C = -2.0 mA, V _{CE} = -5.0 V)	BC856B, BC857B BC857C, BC858C		220 420	290 520	475 800	
Collector – Emitter Saturation Voltage (I _C = -10 mA, I _B = -0.5 mA) (I _C = -100 mA, I _B = -5.0 mA)		V _{CE(sat)}	- -	-	-0.3 -0.65	V
Base – Emitter Saturation Voltage (I _C = -10 mA, I _B = -0.5 mA) (I _C = -100 mA, I _B = -5.0 mA)		V _{BE(sat)}	- -	-0.7 -0.9	- -	V
Base – Emitter On Voltage (I _C = -2.0 mA, V _{CE} = -5.0 V) (I _C = -10 mA, V _{CE} = -5.0 V)		V _{BE(on)}	-0.6 -	-	-0.75 -0.82	V
SMALL-SIGNAL CHARACTERISTICS						
Current – Gain – Bandwidth Product (I _C = -10 mA, V _{CE} = -5.0 Vdc, f = 100 MHz)		f _T	100	-	-	MHz
Output Capacitance (V _{CB} = -10 V, f = 1.0 MHz)		C _{ob}	-	-	4.5	pF
Noise Figure (I _C = -0.2 mA, V _{CE} = -5.0 Vdc, R _S = 2.0 kΩ, f = 1.0 kHz, BW = 200 Hz)		NF	-	-	10	dB

TYPICAL CHARACTERISTICS – BC856

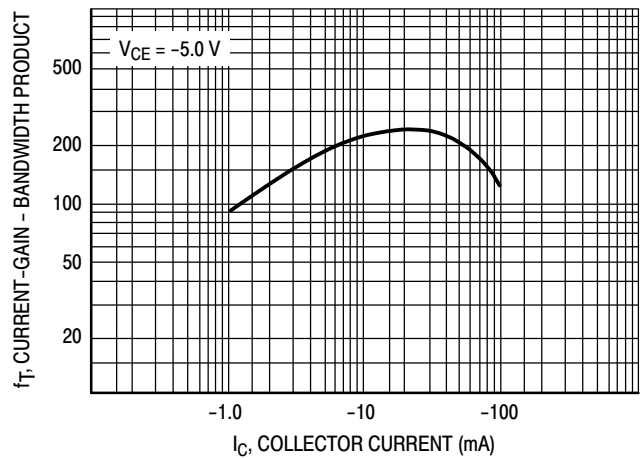
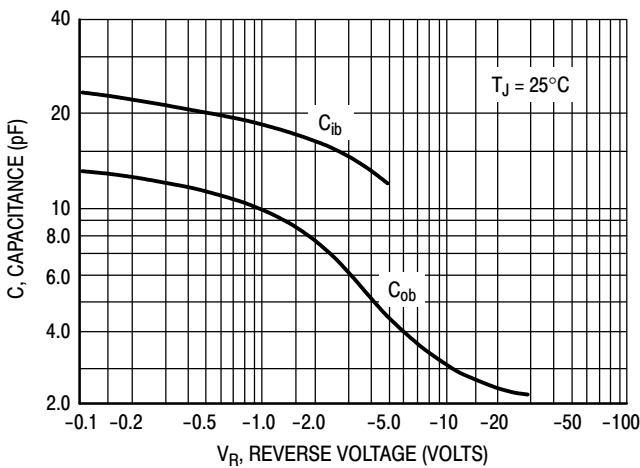
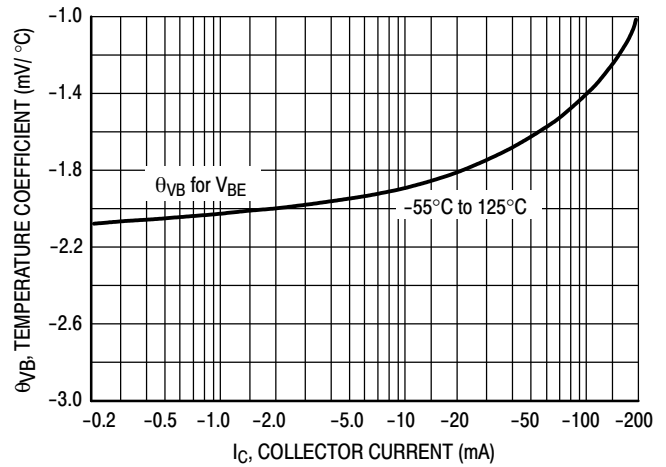
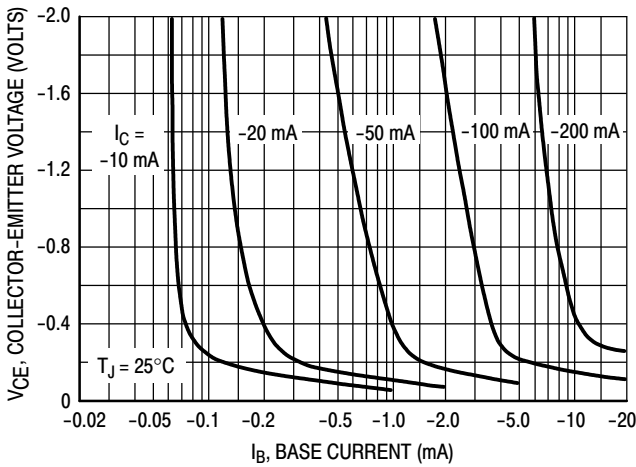
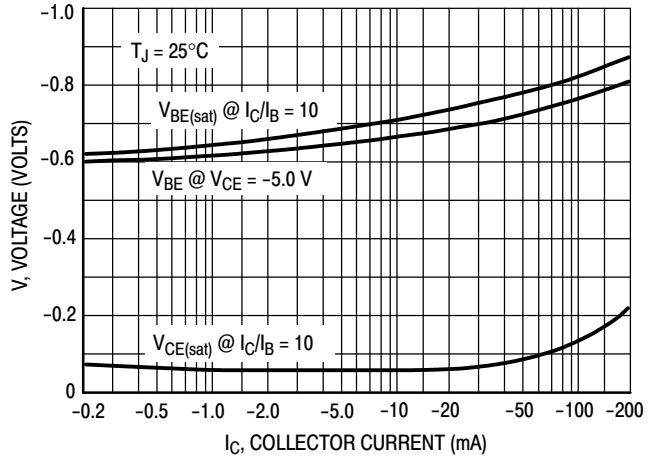
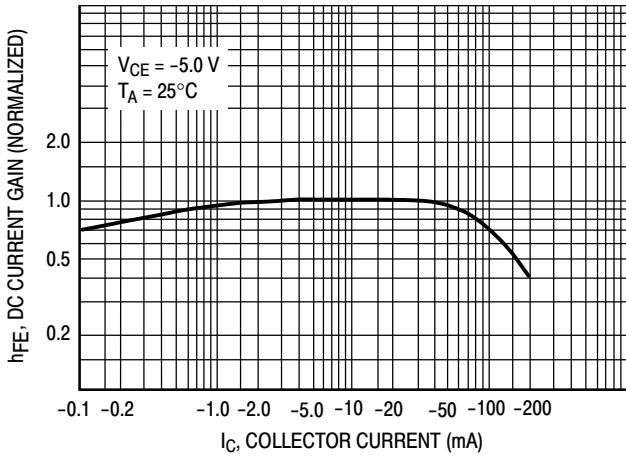

TYPICAL CHARACTERISTICS – BC857/BC858

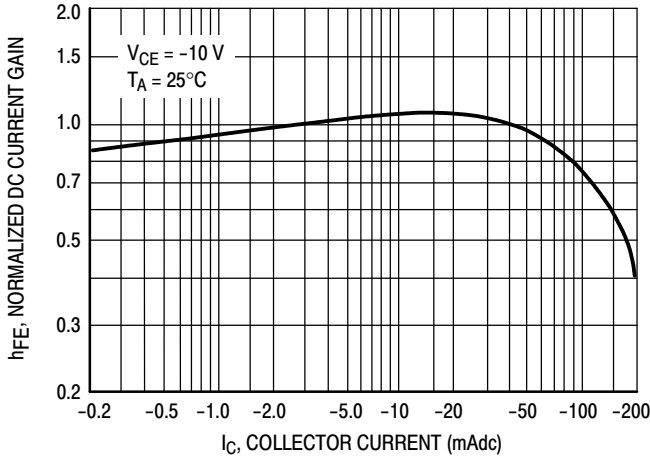

Figure 7. Normalized DC Current Gain

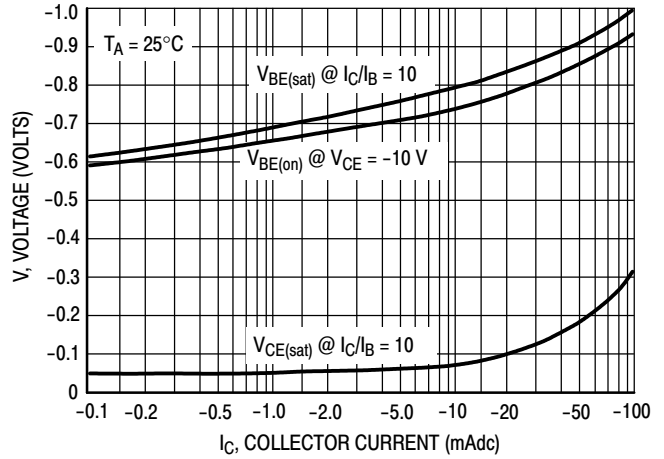

Figure 8. "Saturation" and "On" Voltages

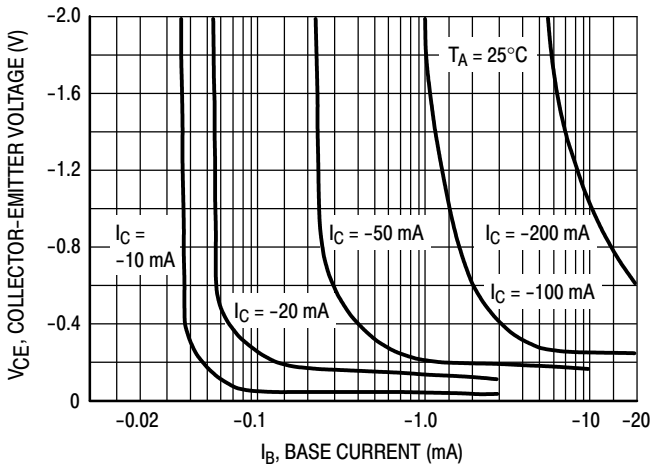

Figure 9. Collector Saturation Region

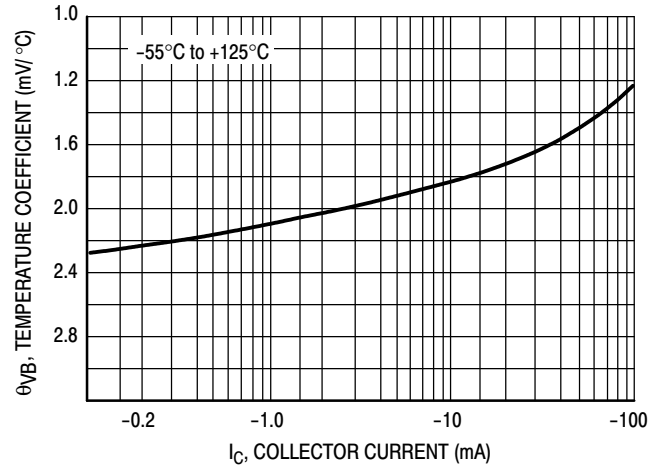

Figure 10. Base-Emitter Temperature Coefficient

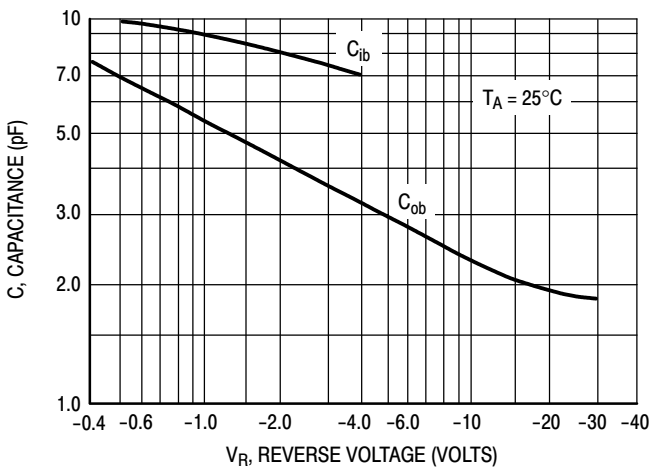

Figure 11. Capacitances

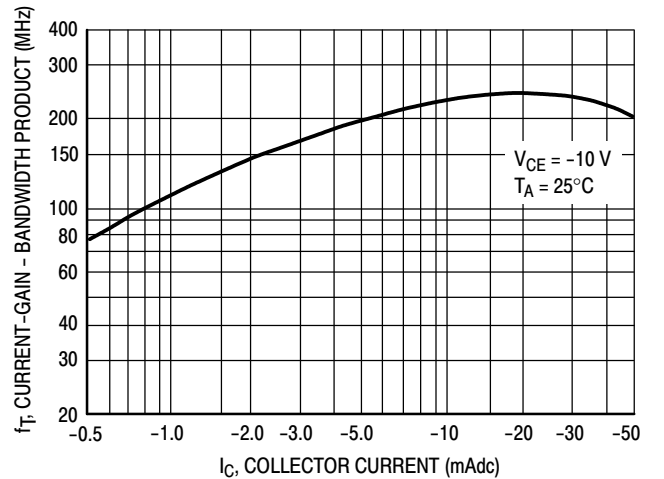

Figure 12. Current-Gain - Bandwidth Product

BC856BDW1T1G, BC857BDW1T1G Series, BC858CDW1T1G Series

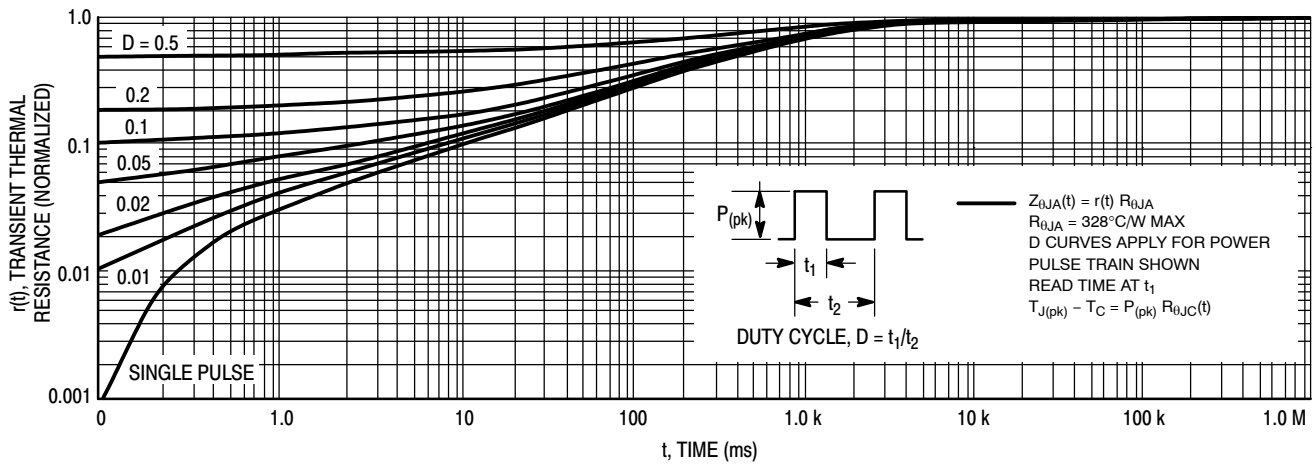

Figure 13. Thermal Response

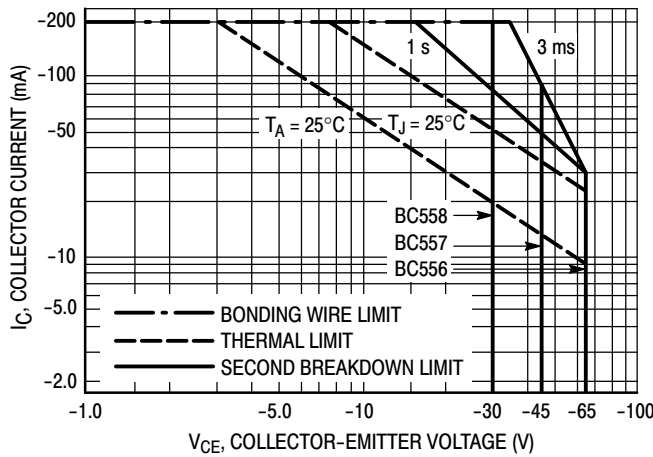

Figure 14. Active Region Safe Operating Area

The safe operating area curves indicate I_C - V_{CE} limits of the transistor that must be observed for reliable operation. Collector load lines for specific circuits must fall below the limits indicated by the applicable curve.

The data of Figure 14 is based upon $T_{J(pk)} = 150^\circ\text{C}$; T_C or T_A is variable depending upon conditions. Pulse curves are valid for duty cycles to 10% provided $T_{J(pk)} \leq 150^\circ\text{C}$. $T_{J(pk)}$ may be calculated from the data in Figure 13. At high case or ambient temperatures, thermal limitations will reduce the power that can be handled to values less than the limitations imposed by the secondary breakdown.

ORDERING INFORMATION

Device	Device Marking	Package	Shipping†
BC856BDW1T1G	3B	SOT-363 (Pb-Free)	3,000 / Tape & Reel
BC856BDW1T3G	3B	SOT-363 (Pb-Free)	10,000 / Tape & Reel
BC857BDW1T1G	3F	SOT-363 (Pb-Free)	3,000 / Tape & Reel
BC857CDW1T1G	3G	SOT-363 (Pb-Free)	3,000 / Tape & Reel
BC858CDW1T1G	3L	SOT-363 (Pb-Free)	3,000 / Tape & Reel

†For information on tape and reel specifications, including part orientation and tape sizes, please refer to our Tape and Reel Packaging Specifications Brochure, BRD8011/D.

BC856BDW1T1G, BC857BDW1T1G Series, BC858CDW1T1G Series

PACKAGE DIMENSIONS

SC-88/SC70-6/SOT-363
CASE 419B-02
ISSUE W

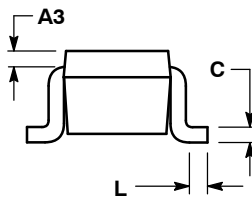
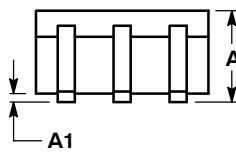
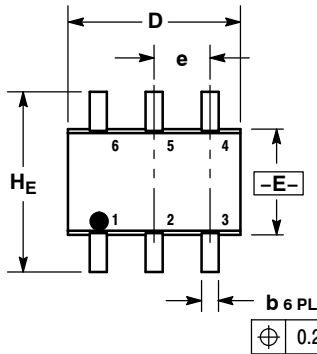

NOTES:

1. DIMENSIONING AND TOLERANCING PER ANSI Y14.5M, 1982.
2. CONTROLLING DIMENSION: INCH.
3. 419B-01 OBSOLETE, NEW STANDARD 419B-02.

DIM	MILLIMETERS			INCHES		
	MIN	NOM	MAX	MIN	NOM	MAX
A	0.80	0.95	1.10	0.031	0.037	0.043
A1	0.00	0.05	0.10	0.000	0.002	0.004
A3	0.20 REF			0.008 REF		
b	0.10	0.21	0.30	0.004	0.008	0.012
C	0.10	0.14	0.25	0.004	0.005	0.010
D	1.80	2.00	2.20	0.070	0.078	0.086
E	1.15	1.25	1.35	0.045	0.049	0.053
e	0.65 BSC			0.026 BSC		
L	0.10	0.20	0.30	0.004	0.008	0.012
HE	2.00	2.10	2.20	0.078	0.082	0.086

STYLE 1:

- PIN 1: EMITTER 2
- 2: BASE 2
- 3: COLLECTOR 1
- 4: EMITTER 1
- 5: BASE 1
- 6: COLLECTOR 2

SOLDERING FOOTPRINT*

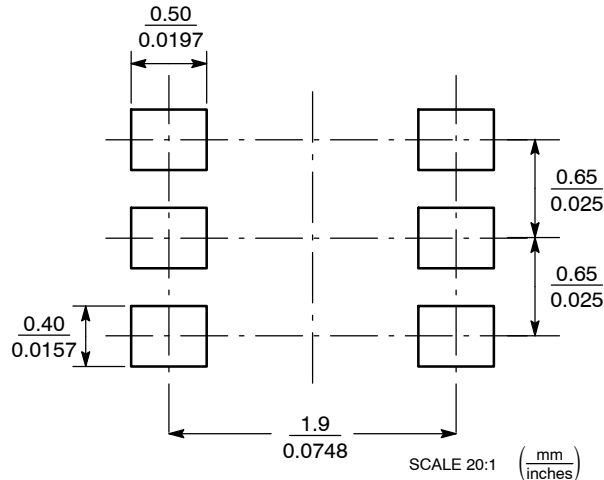

*For additional information on our Pb-Free strategy and soldering details, please download the ON Semiconductor Soldering and Mounting Techniques Reference Manual, SOLDERM/D.

ON Semiconductor and are registered trademarks of Semiconductor Components Industries, LLC (SCILLC). SCILLC reserves the right to make changes without further notice to any products herein. SCILLC makes no warranty, representation or guarantee regarding the suitability of its products for any particular purpose, nor does SCILLC assume any liability arising out of the application or use of any product or circuit, and specifically disclaims any and all liability, including without limitation special, consequential or incidental damages. "Typical" parameters which may be provided in SCILLC data sheets and/or specifications can and do vary in different applications and actual performance may vary over time. All operating parameters, including "Typicals" must be validated for each customer application by customer's technical experts. SCILLC does not convey any license under its patent rights nor the rights of others. SCILLC products are not designed, intended, or authorized for use as components in systems intended for surgical implant into the body, or other applications intended to support or sustain life, or for any other application in which the failure of the SCILLC product could create a situation where personal injury or death may occur. Should Buyer purchase or use SCILLC products for any such unintended or unauthorized application, Buyer shall indemnify and hold SCILLC and its officers, employees, subsidiaries, affiliates, and distributors harmless against all claims, costs, damages, and expenses, and reasonable attorney fees arising out of, directly or indirectly, any claim of personal injury or death associated with such unintended or unauthorized use, even if such claim alleges that SCILLC was negligent regarding the design or manufacture of the part. SCILLC is an Equal Opportunity/Affirmative Action Employer. This literature is subject to all applicable copyright laws and is not for resale in any manner.

PUBLICATION ORDERING INFORMATION

LITERATURE FULFILLMENT:
Literature Distribution Center for ON Semiconductor
P.O. Box 5163, Denver, Colorado 80217 USA
Phone: 303-675-2175 or 800-344-3860 Toll Free USA/Canada
Fax: 303-675-2176 or 800-344-3867 Toll Free USA/Canada
Email: orderlit@onsemi.com

N. American Technical Support: 800-282-9855 Toll Free
USA/Canada
Europe, Middle East and Africa Technical Support:
Phone: 421 33 790 2910
Japan Customer Focus Center
Phone: 81-3-5773-3850

ON Semiconductor Website: www.onsemi.com
Order Literature: <http://www.onsemi.com/orderlit>

For additional information, please contact your local Sales Representative