



Micro Commercial Components

Micro Commercial Components
20736 Marilla Street Chatsworth
CA 91311
Phone: (818) 701-4933
Fax: (818) 701-4939

2SC1623-L6 2SC1623-L7

Features

- Lead Free Finish/RoHS Compliant ("P" Suffix designates RoHS Compliant. See ordering information)
- High DC Current Gain: $h_{FE}=600$ Max. ($V_{CE}=6.0V$, $I_C=1.0mA$)
- High voltage: $V_{CEO}=50V$
- Epoxy meets UL 94 V-0 flammability rating
- Moisture Sensitivity Level 1

Maximum Ratings

Symbol	Rating	Rating	Unit
V_{CEO}	Collector-Emitter Voltage	50	V
V_{CBO}	Collector-Base Voltage	60	V
V_{EBO}	Emitter-Base Voltage	5.0	V
I_C	Collector Current	100	mA
P_C	Collector power dissipation	200	mW
T_J	Junction Temperature	-55 to +150	°C
T_{STG}	Storage Temperature	-55 to +150	°C

Electrical Characteristics @ 25°C Unless Otherwise Specified

Symbol	Parameter	Min	Typ	Max	Units
--------	-----------	-----	-----	-----	-------

OFF CHARACTERISTICS

I_{CBO}	Collector Cutoff Current ($V_{CB}=60Vdc, I_E=0$)	---	---	0.1	μA
I_{EBO}	Emitter Cutoff Current ($V_{EB}=5.0Vdc, I_C=0$)	---	---	0.1	μA

ON CHARACTERISTICS

h_{FE}	DC Current Gain* ($I_C=1.0mA, V_{CE}=6.0Vdc$)	200	---	600	---
$V_{CE(sat)}$	Collector Saturation Voltage* ($I_C=100mA, I_B=10mA$)	---	0.15	0.3	Vdc
$V_{BE(sat)}$	Base Saturation Voltage* ($I_C=100mA, I_B=10mA$)	---	0.86	1.0	Vdc
V_{BE}	Base Emitter Voltage* ($V_{CE}=6.0Vdc, I_C=1.0mA$)	0.55	0.62	0.65	Vdc
C_{ob}	Collector Capacitance ($V_{CB}=6.0Vdc, I_E=0, f=1.0MHz$)	---	3.0	---	pF
f_T	Gain Bandwidth product ($V_{CE}=6.0Vdc, I_E=10mA$)	---	250	---	MHz

h_{FE} CLASSIFICATION

Marking	L6	L7
h_{FE}	200-400	400-600

* Pulse Test PW<350us, duty cycle<2%

NPN Silicon Epitaxial Transistors

SOT-23

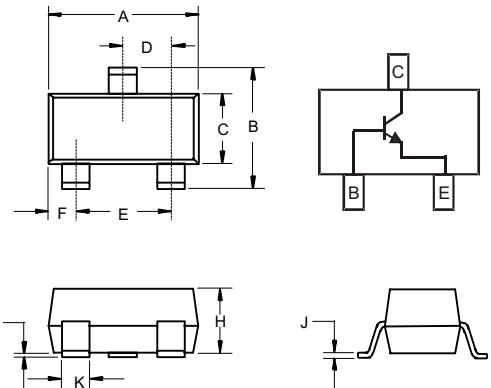

DIM	INCHES		MM		NOTE
	MIN	MAX	MIN	MAX	
A	.110	.120	2.80	3.04	
B	.083	.098	2.10	2.64	
C	.047	.055	1.20	1.40	
D	.035	.041	.89	1.03	
E	.070	.081	1.78	2.05	
F	.018	.024	.45	.60	
G	.0005	.0039	.013	.100	
H	.035	.044	.89	1.12	
J	.003	.007	.085	.180	
K	.015	.020	.37	.51	

Suggested Solder Pad Layout

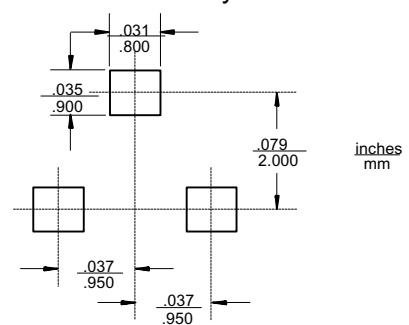

Typical Characteristics

TOTAL POWER DISSIPATION vs. AMBIENT TEMPERATURE

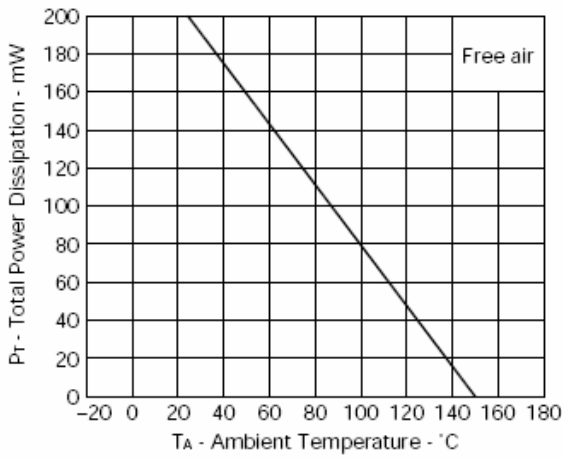

NORMALIZED COLLECTOR CUTOFF CURRENT vs. AMBIENT TEMPERATURE

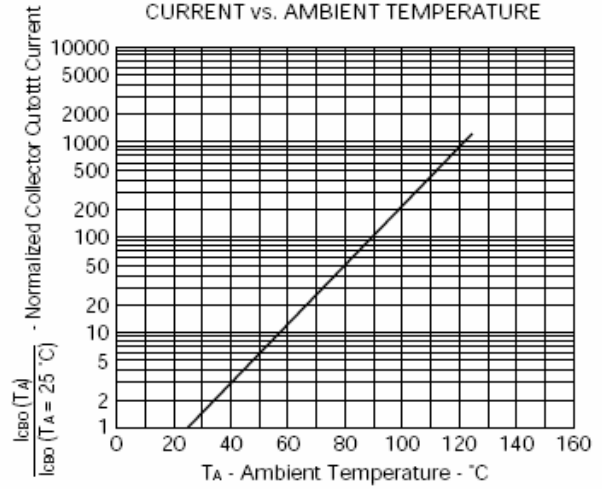

COLLECTOR CURRENT vs. COLLECTOR TO EMITTER VOLTAGE

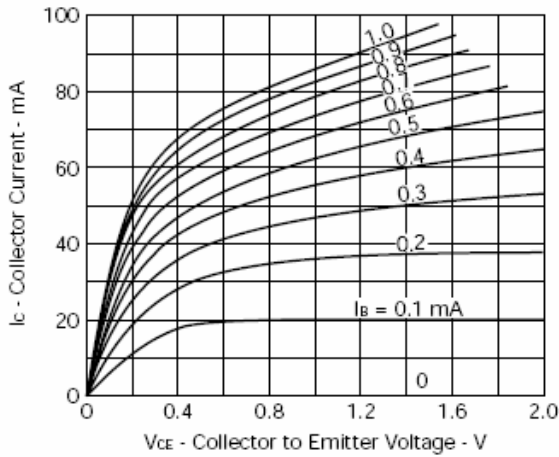

COLLECTOR CURRENT vs. COLLECTOR TO EMITTER VOLTAGE

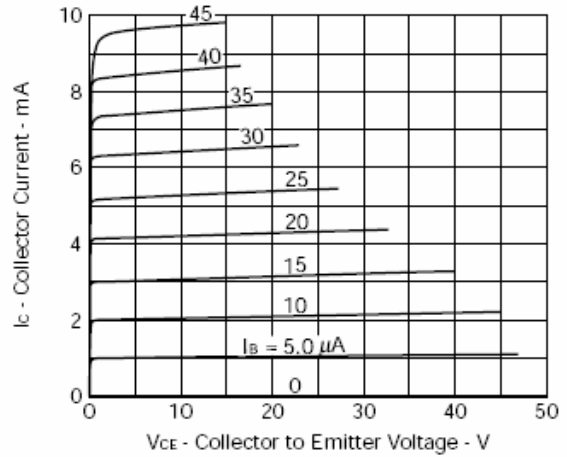

DC CURRENT GAIN vs. COLLECTOR CURRENT

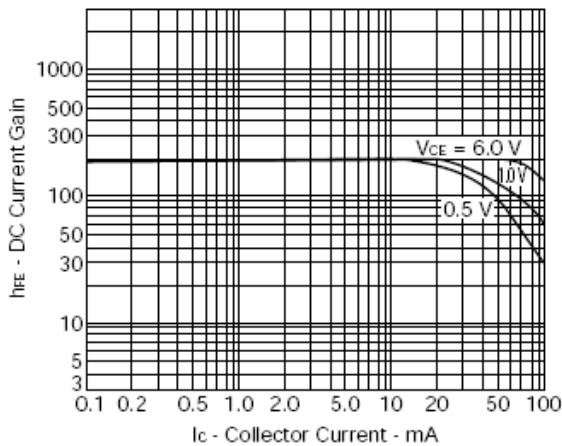

DC CURRENT GAIN vs. COLLECTOR CURRENT

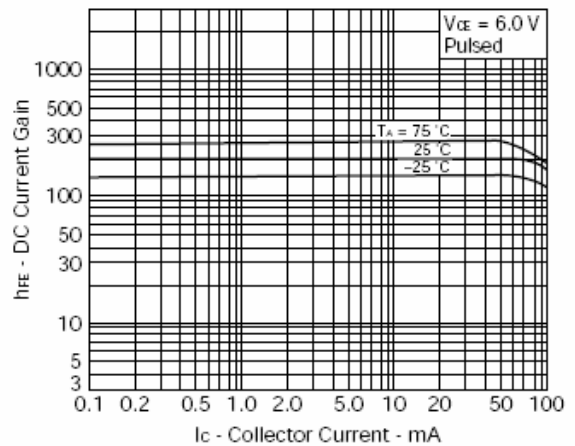

Typical Characteristics

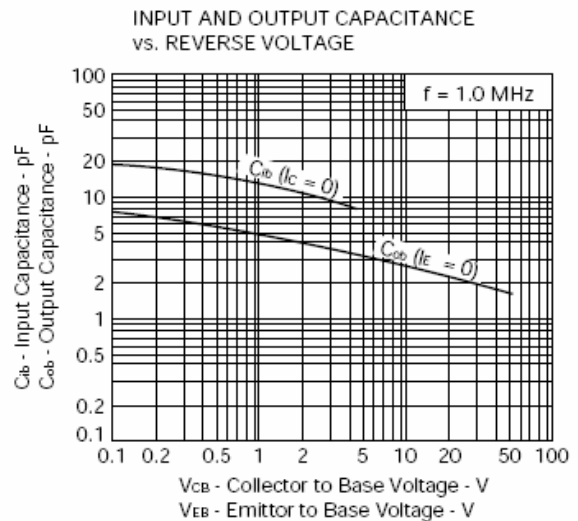
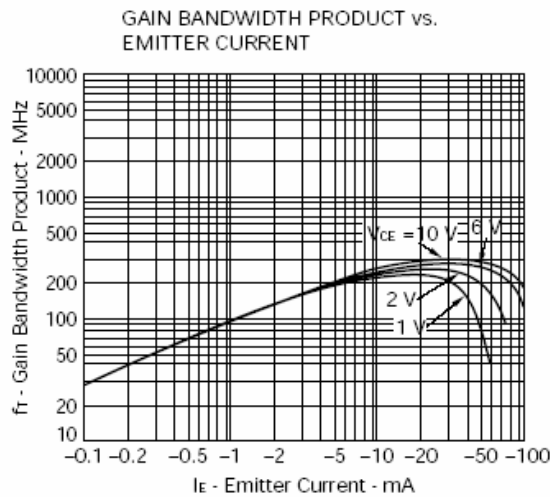
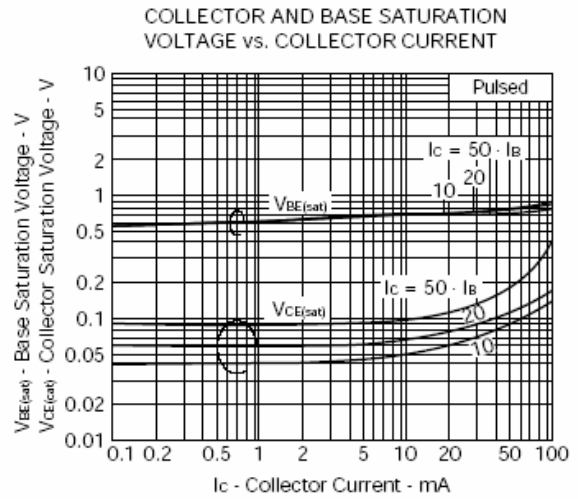
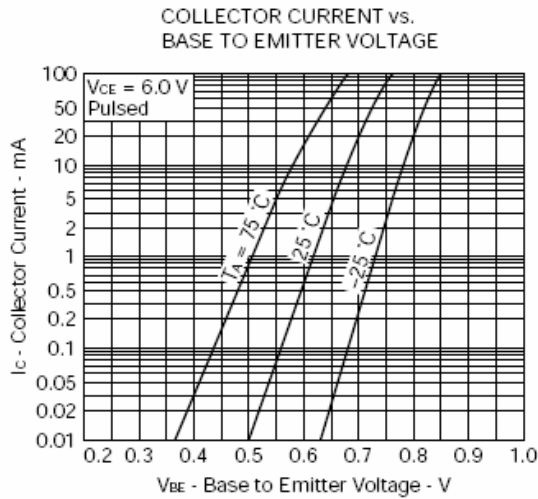



TM

Micro Commercial Components

Ordering Information :

Device	Packing
Part Number-TP	Tape&Reel; 3Kpcs/Reel

IMPORTANT NOTICE

Micro Commercial Components Corp. reserves the right to make changes without further notice to any product herein to make corrections, modifications, enhancements, improvements, or other changes. **Micro Commercial Components Corp.** does not assume any liability arising out of the application or use of any product described herein; neither does it convey any license under its patent rights, nor the rights of others. The user of products in such applications shall assume all risks of such use and will agree to hold **Micro Commercial Components Corp.** and all the companies whose products are represented on our website, harmless against all damages.

LIFE SUPPORT

MCC's products are not authorized for use as critical components in life support devices or systems without the express written approval of Micro Commercial Components Corporation.

CUSTOMER AWARENESS

Counterfeiting of semiconductor parts is a growing problem in the industry. Micro Commercial Components (MCC) is taking strong measures to protect ourselves and our customers from the proliferation of counterfeit parts. MCC strongly encourages customers to purchase MCC parts either directly from MCC or from Authorized MCC Distributors who are listed by country on our web page cited below. Products customers buy either from MCC directly or from Authorized MCC Distributors are genuine parts, have full traceability, meet MCC's quality standards for handling and storage. **MCC will not provide any warranty coverage or other assistance for parts bought from Unauthorized Sources.** MCC is committed to combat this global problem and encourage our customers to do their part in stopping this practice by buying direct or from authorized distributors.

www.mccsemi.com