

> **Features**

- High Current
- Low On-Resistance
- No Secondary Breakdown
- Low Driving Power
- Avalanche Rated

> **Applications**

- Motor Control
- General Purpose Power Amplifier
- DC-DC converters

> **Outline Drawing**

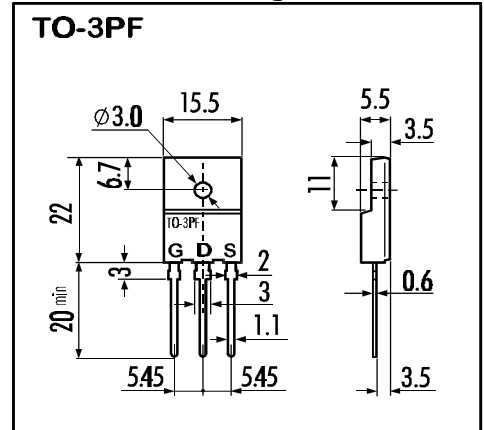

> **Maximum Ratings and Characteristics**

- Absolute Maximum Ratings ( $T_C=25^\circ\text{C}$ ), unless otherwise specified

Item	Symbol	Rating	Unit
Drain-Source-Voltage	$V_{DS}$	60	V
Continous Drain Current	$I_D$	70	A
Pulsed Drain Current	$I_{D(puls)}$	280	A
Gate-Source-Voltage	$V_{GS}$	$\pm 20$	V
Maximum Avalanche Energy	$E_{AV}$	685	mJ*
Max. Power Dissipation	$P_D$	100	W
Operating and Storage Temperature Range	$T_{ch}$	150	$^\circ\text{C}$
	$T_{stg}$	-55 ~ +150	$^\circ\text{C}$

\*  $L=0,186\text{mH}$ ,  $V_{CC}=24\text{V}$

> **Equivalent Circuit**

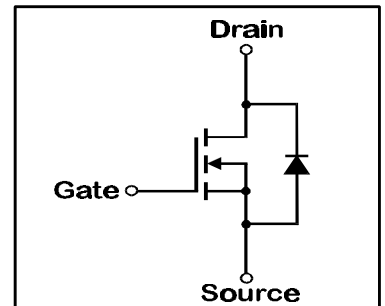

- Electrical Characteristics ( $T_C=25^\circ\text{C}$ ), unless otherwise specified

Item	Symbol	Test conditions	Min.	Typ.	Max.	Unit
Drain-Source Breakdown-Voltage	$V_{(BR)DSS}$	$I_D=1\text{mA}$ $V_{GS}=0\text{V}$	60			V
Gate Threshold Voltage	$V_{GS(th)}$	$I_D=1\text{mA}$ $V_{DS}=V_{GS}$	1,0	1,5	2,0	V
Zero Gate Voltage Drain Current	$I_{DSS}$	$V_{DS}=60\text{V}$ $T_{ch}=25^\circ\text{C}$		10	500	$\mu\text{A}$
		$V_{GS}=0\text{V}$ $T_{ch}=125^\circ\text{C}$		0,2	1,0	mA
Gate Source Leakage Current	$I_{GSS}$	$V_{GS}=\pm 20\text{V}$ $V_{DS}=0\text{V}$		10	100	nA
Drain Source On-State Resistance	$R_{DS(on)}$	$I_D=40\text{A}$ $V_{GS}=4\text{V}$		0,012	0,017	$\Omega$
		$V_{GS}=10\text{V}$		0,0075	0,01	$\Omega$
Forward Transconductance	$g_{fs}$	$I_D=40\text{A}$ $V_{DS}=25\text{V}$	25	55		S
Input Capacitance	$C_{iss}$	$V_{DS}=25\text{V}$		3500	5250	pF
Output Capacitance	$C_{oss}$	$V_{GS}=0\text{V}$		1250	1870	pF
Reverse Transfer Capacitance	$C_{rss}$	$f=1\text{MHz}$		360	540	pF
Turn-On-Time $t_{on}$ ( $t_{on}=t_{d(on)}+t_r$ )	$t_{d(on)}$	$V_{CC}=30\text{V}$		15	23	ns
	$t_r$	$I_D=75\text{A}$		75	120	ns
Turn-Off-Time $t_{off}$ ( $t_{off}=t_{d(off)}+t_f$ )	$t_{d(off)}$	$V_{GS}=10\text{V}$		190	285	ns
	$t_f$	$R_{GS}=10\ \Omega$		110	165	ns
Avalanche Capability	$I_{AV}$	$L=100\ \mu\text{H}$ $T_{ch}=25^\circ\text{C}$	70			A
Diode Forward On-Voltage	$V_{SD}$	$I_F=160\text{A}$ $V_{GS}=0\text{V}$ $T_{ch}=25^\circ\text{C}$		1,15	1,65	V
Reverse Recovery Time	$t_{rr}$	$I_F=80\text{A}$ $V_{GS}=0\text{V}$		75	120	ns
Reverse Recovery Charge	$Q_{rr}$	$-di_F/dt=100\text{A}/\mu\text{s}$ $T_{ch}=25^\circ\text{C}$		0,17		$\mu\text{C}$

- Thermal Characteristics

Item	Symbol	Test conditions	Min.	Typ.	Max.	Unit
Thermal Resistance	$R_{th(ch-a)}$	channel to air			30	$^\circ\text{C}/\text{W}$
	$R_{th(ch-c)}$	channel to case			1,25	$^\circ\text{C}/\text{W}$

# N-channel MOS-FET

60V | 0,01Ω | 70A | 100W

# 2SK2691-01R

## FAP-III B Series



### > Characteristics

Typical Output Characteristics

$I_D = f(V_{DS})$ ; 80μs pulse test;  $T_{ch} = 25^\circ\text{C}$

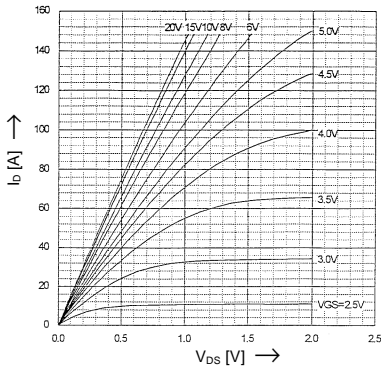

Drain-Source On-State Resistance vs.  $T_{ch}$

$R_{DS(on)} = f(T_{ch})$ ;  $I_D = 40\text{A}$ ;  $V_{GS} = 10\text{V}$

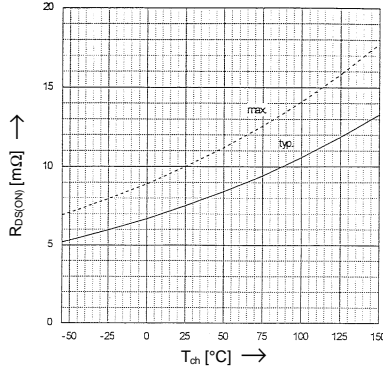

Typical Transfer Characteristics

$I_D = f(V_{GS})$ ; 80μs pulse test;  $V_{DS} = 25\text{V}$ ;  $T_{ch} = 25^\circ\text{C}$

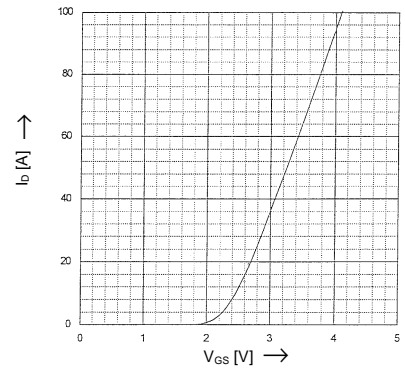

Typical Drain-Source On-State-Resistance vs.  $I_D$

$R_{DS(on)} = f(I_D)$ ; 80μs pulse test;  $T_{ch} = 25^\circ\text{C}$

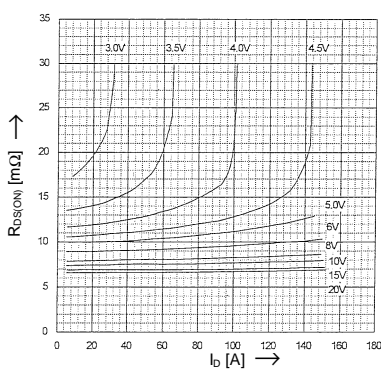

Typical Forward Transconductance vs.  $I_D$

$g_{fs} = f(I_D)$ ; 80μs pulse test;  $V_{DS} = 25\text{V}$ ;  $T_{ch} = 25^\circ\text{C}$

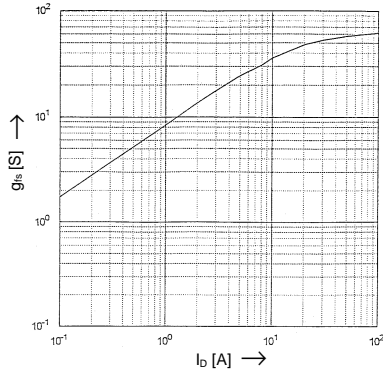

Gate Threshold Voltage vs.  $T_{ch}$

$V_{GS(th)} = f(T_{ch})$ ;  $I_D = 1\text{mA}$ ;  $V_{DS} = V_{GS}$

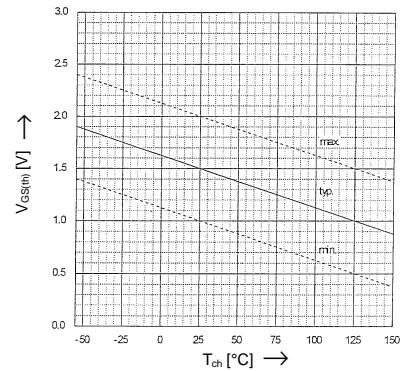

Typical Capacitances vs.  $V_{DS}$

$C = f(V_{DS})$ ;  $V_{GS} = 0\text{V}$ ;  $f = 1\text{MHz}$

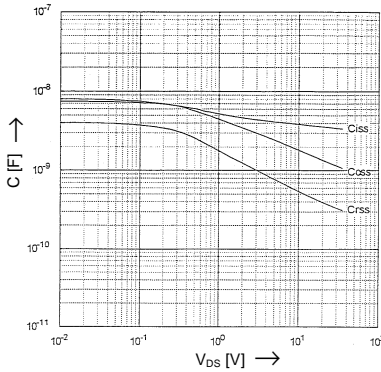

Typical Gate Charge Characteristic

$V_{GS} = f(Q_g)$ ;  $I_D = 80\text{A}$ ;  $T_{ch} = 25^\circ\text{C}$

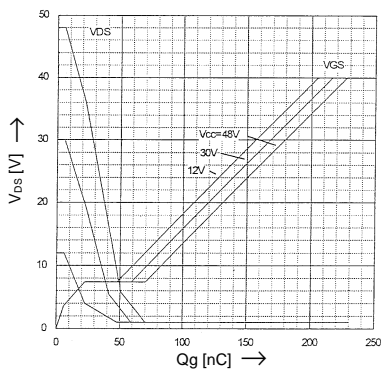

Forward Characteristics of Reverse Diode

$I_F = f(V_{SD})$ ; 80μs pulse test;  $T_{ch} = 25^\circ\text{C}$

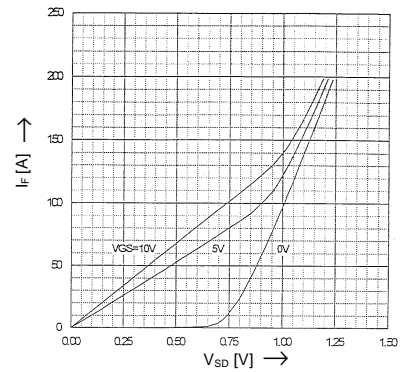

Maximum Avalanche Energy vs. starting  $T_{ch}$

$E_{AV} = f(\text{starting } T_{ch})$ ;  $V_{CC} = 24\text{V}$ ;  $I_{AV} \leq 70\text{A}$

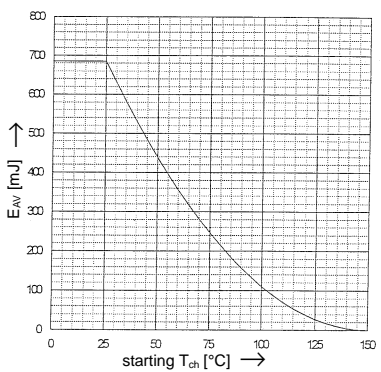

Safe Operation Area

$I_D = f(V_{DS})$ ;  $D = 0,01$ ;  $T_c = 25^\circ\text{C}$

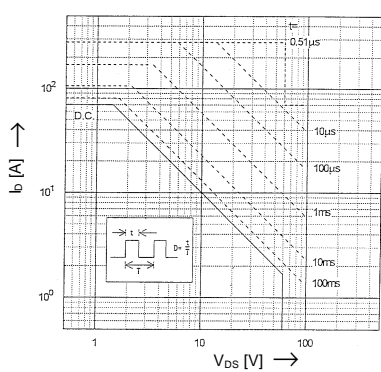

Transient Thermal impedance

Transient Thermal impedance

$Z_{th(ch-e)} = f(t)$  parameter:  $D = t/T$

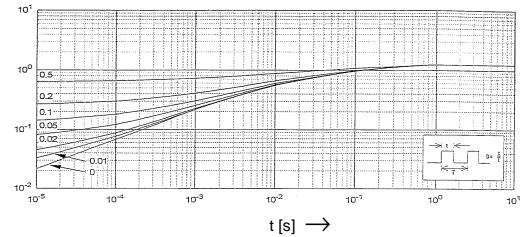

N-channel MOS-FET			
60V	0,01Ω	70A	100W

# 2SK2691-01R

## FAP-III B Series



### > Characteristics

Power Dissipation  
 $P_D=f(T_C)$

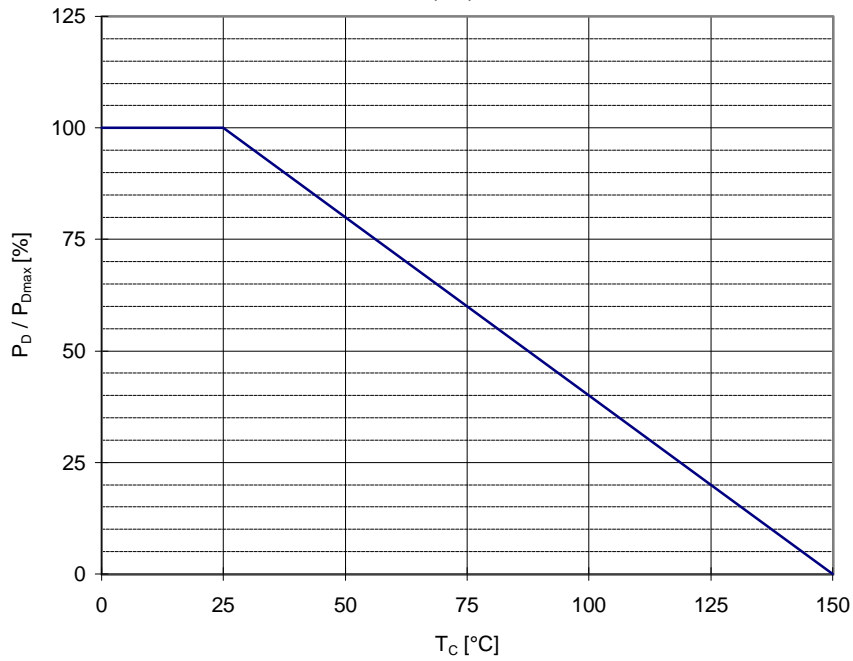

Maximum Avalanche Current vs. starting  $T_{ch}$   
 $I_{AV}=f(\text{starting } T_{ch})$

