

SAW Duplexers

Type: EFSD□□□□D□□□□
 EFSD□□□□E□□□□
 EFSD□□□□F□□□□

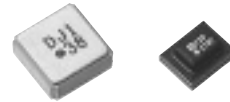

SAW Duplexer for Cellular Telephone which incorporates highly-precise interdigitated electrodes achieves low insertion loss, high selectivity. And unique electrode material achieves high power durability thus the duplexer has wide applications to antenna duplexer circuits for cellular telephones.

■ Features

- Stable against severe conditions of vibration and shock thanks to the unique monolithic construction of the filter
- Low insertion loss and excellent selectivity
- Contributes to circuit simplification and adjustment free
- Saves the height on PC board

■ Recommended Applications

- The antenna duplexer for cellular telephone

■ Explanation of Part Numbers

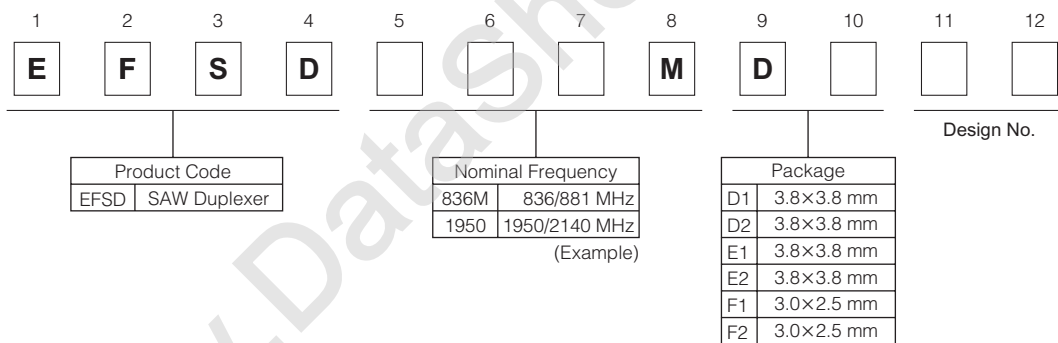

■ Ratings and Characteristics

Part No.	System	Nominal Center Frequency	Input/Output Impedance	Size	Package
EFSD836MD1□□	CDMA	836.5/881.5 MHz	UB-UB(50 Ω-50 Ω)	3.8×3.8 mm	KA
EFSD836MD2□□					
EFSD836ME1□□					
EFSD836ME2□□				3.0×2.5 mm	F
EFSD836MF1□□					
EFSD836MF2□□					
EFSD906MD1□□	J-CDMA	851.0/906.0 MHz	UB-UB(50 Ω-50 Ω)	3.8×3.8 mm	KA
EFSD906MD2□□					
EFSD911MD1□□					
EFSD911MD2□□		3.0×2.5 mm		F	
EFSD911MF1□□					
EFSD911MF2□□					
EFSD1765D1□□	KPCS	1765.0/1855.0 MHz	UB-UB(50 Ω-50 Ω)	3.8×3.8 mm	KD
EFSD1765D2□□					
EFSD1950D1□□	WCDMA	1950.0/2140.0 MHz	UB-UB(50 Ω-50 Ω)	3.8×3.8 mm	KT
EFSD1950D2□□					

* UB : Unbalance, B : Balance

■ Dimensions in mm (not to scale)

YD type

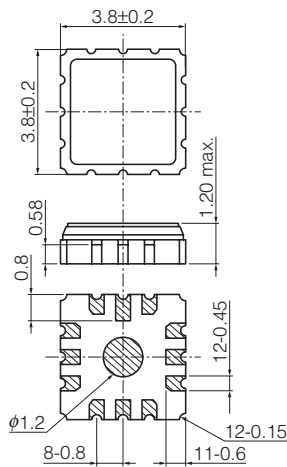

KA type

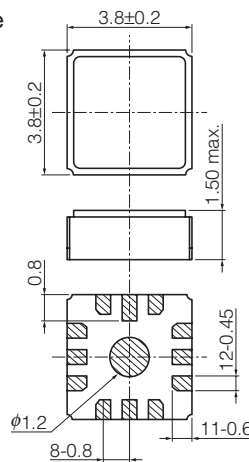

KD type

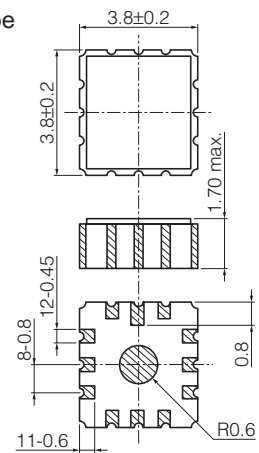

KT type

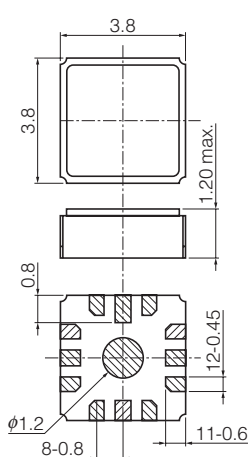

F type

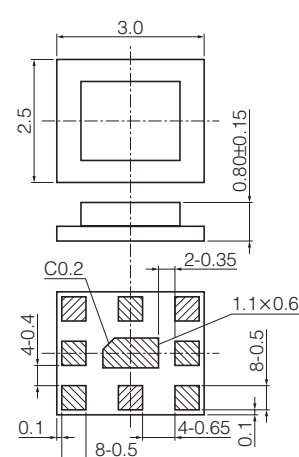

■ Packaging Methods (Taping)

- Minimum Quantity / Packing Unit

Part Number	Packaging Style	Quantity	Packaging Quantity in Carton	Carton Dimensions in mm (LxWxH)
EFCH□□□□D□□□	Embossed Carrier Taping	4000 pcs./reel	20000 pcs.	338×350×100
EFCH□□□□E□□□	Embossed Carrier Taping	4000 pcs./reel	20000 pcs.	338×350×100
EFCH□□□□F□□□	Embossed Carrier Taping	2000 pcs./reel	10000 pcs.	230×220× 73

- Embossed Carrier Taping

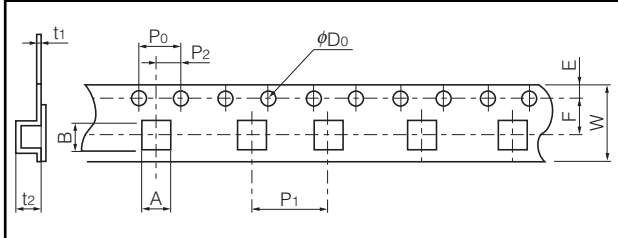

YD, KA, KD, KT type

Symbol	W	F	E	P_0	P_1	P_2	D_0	t_1	t_2	A	B
Dim. (mm)	12.0±0.2	5.5±0.1	1.75±0.10	4.0±0.1	8.0±0.1	2.0±0.1	$\phi 1.5^{+0.1}_{-0}$	0.30±0.05	1.8±0.1	4.2±0.1	4.2±0.1

F type

Symbol	W	F	E	P_0	P_1	P_2	D_0	t_1	t_2	A	B
Dim. (mm)	8.0±0.2	3.50±0.05	1.75±0.10	4.0±0.1	4.0±0.1	2.00±0.05	$\phi 1.5^{+0.1}_{-0}$	0.25±0.05	1.25±0.1	2.9±0.1	3.40±0.05

- Taping Reel

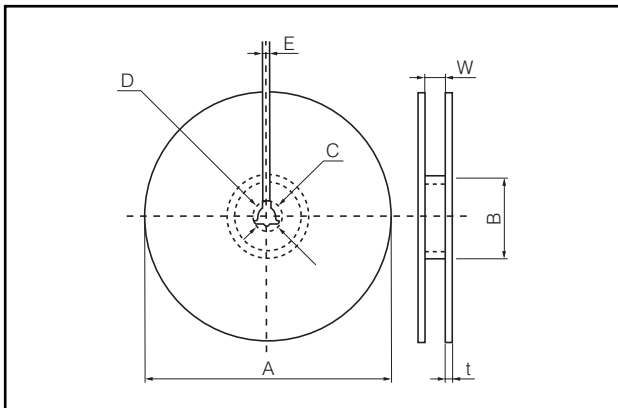

YD, KA, KD, KT type

Symbol	A	B	C	D	E	W	t
Dim. (mm)	$\phi 330 \pm 2$	$\phi 100 \pm 1$	$\phi 13.0 \pm 0.5$	$\phi 21.0 \pm 1.0$	2.0±0.5	13.5±1.0	max. 3

F type

Symbol	A	B	C	D	E	W	t
Dim. (mm)	$\phi 180 \pm 3$	$\phi 60.0 \pm 1.0$	$\phi 13.0 \pm 0.5$	$\phi 21.0 \pm 1.0$	2.0±0.5	9.0±1.0	max. 3