

GBC556

PNP SILICON TRANSISTOR

Description

The GBC556 is designed for drive and output-stages of audio amplifiers.

Features

- High DC Current Gain: 120~800 @ $V_{CE}=-5V$, $I_C=-2mA$
- Complementary to GBC546

Package Dimensions

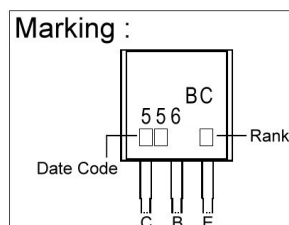
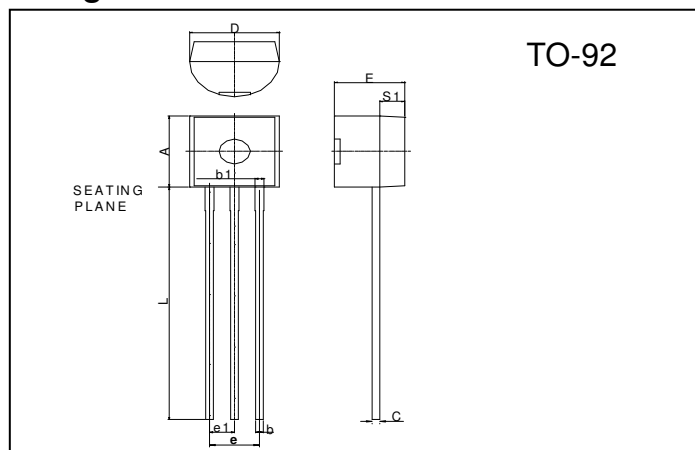

REF.	Millimeter		REF.	Millimeter	
	Min.	Max.		Min.	Max.
A	4.45	4.7	D	4.44	4.7
S1	1.02	-	E	3.30	3.81
b	0.36	0.51	L	12.70	-
b1	0.36	0.76	e1	1.150	1.390
C	0.36	0.51	e	2.42	2.66

Absolute Maximum Ratings ($T_A=25^{\circ}C$)

Parameter	Symbol	Ratings	Unit
Collector to Base Voltage	V_{CBO}	-80	V
Collector to Emitter Voltage	V_{CEO}	-65	V
Emitter to Base Voltage	V_{EBO}	-5	V
Collector Current (continuous)	I_C	-100	mA
Total Device Dissipation @ $T_A = 25^{\circ}C$ Derate above $25^{\circ}C$	P_D	625 5.0	mW mW/ $^{\circ}C$
Total Device Dissipation @ $T_C = 25^{\circ}C$ Derate above $25^{\circ}C$	P_D	1.5 12	W mW/ $^{\circ}C$
Operating and Storage Junction Temperature	T_J, T_{stg}	-55 ~ +150	$^{\circ}C$
Thermal Resistance, Junction to Ambient	$R_{\theta JA}$	200	$^{\circ}C/W$
Thermal Resistance, Junction to Case	$R_{\theta JC}$	83.3	$^{\circ}C/W$

Electrical Characteristics ($T_A = 25^{\circ}C$ unless otherwise noted)

Symbol	Min.	Typ.	Max.	Unit	Test Conditions
V_{CBO}	-80	-	-	V	$I_C=-100\mu A, I_E=0$
V_{CEO}	-65	-	-	V	$I_C=-2mA, I_B=0$
V_{EBO}	-5	-	-	V	$I_E=-100\mu A, I_C=0$
I_{CES}	-	-	-100	nA	$V_{CE}=-40V, V_{BE}=0$
* $V_{CE(sat)1}$	-	-0.075	-0.3	V	$I_C=-10mA, I_B=-0.5mA$
* $V_{CE(sat)2}$	-	-0.25	-0.65	V	$I_C=-100mA, I_B=-5mA$
* $V_{BE(sat)1}$	-	-0.7	-	V	$I_C=-10mA, I_B=-0.5mA$
* $V_{BE(sat)2}$	-	-1.0	-	V	$I_C=-100mA, I_B=-5mA$
* $V_{BE(on)1}$	-0.55	-0.62	-0.7	V	$V_{CE}=-5V, I_C=-2mA$
* $V_{BE(on)2}$	-	-0.7	-0.82	V	$V_{CE}=-5V, I_C=-10mA$
* h_{FE}	120	-	800		$V_{CE}=-5V, I_C=-2mA$
f _T	-	280	-	MHz	$V_{CE}=-5V, I_C=-10mA, f=100MHz$
C _{ob}	-	3.0	6.0	pF	$V_{CB}=-10V, I_C=0, f=1MHz$

*Pulse Test: Pulse Width $\leq 380\mu s$, Duty Cycle $\leq 2\%$

Classification Of h_{FE}

Rank	A	B	C
Range	120 ~ 220	180 ~ 460	420 ~ 800

Characteristics Curve

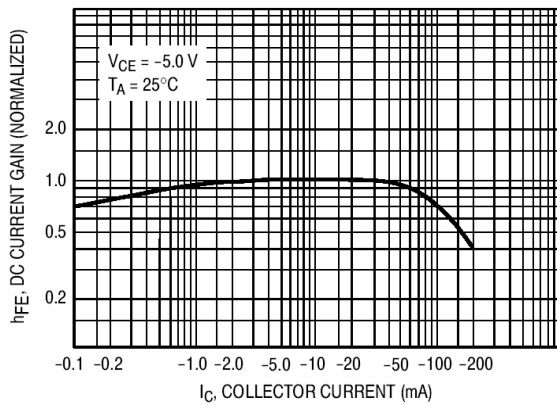

Fig 1. DC Current Gain

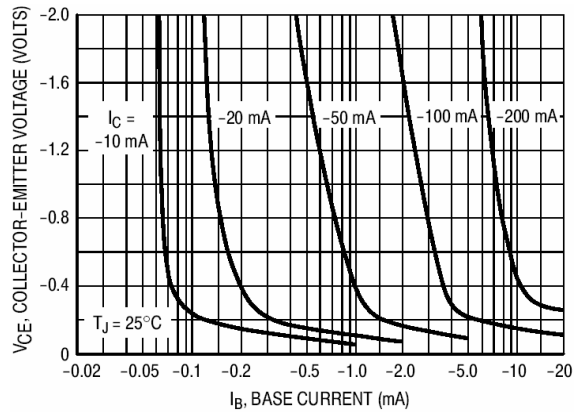

Fig 2. Collector Saturation Region

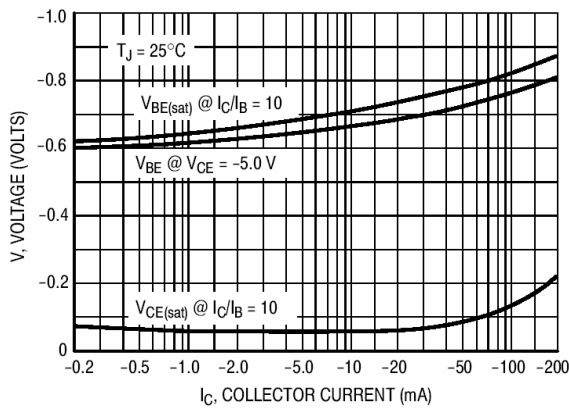

Fig 3. "On" Voltages

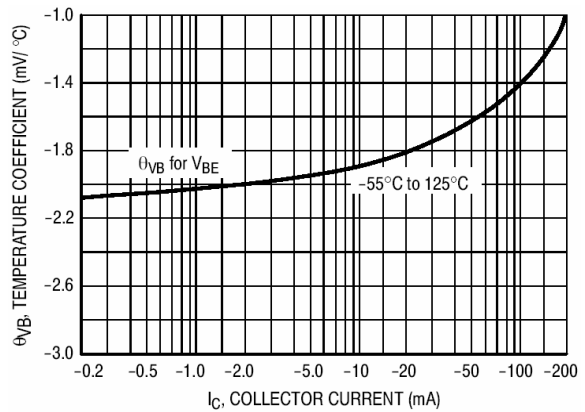

Fig 4. Temperature Coefficients

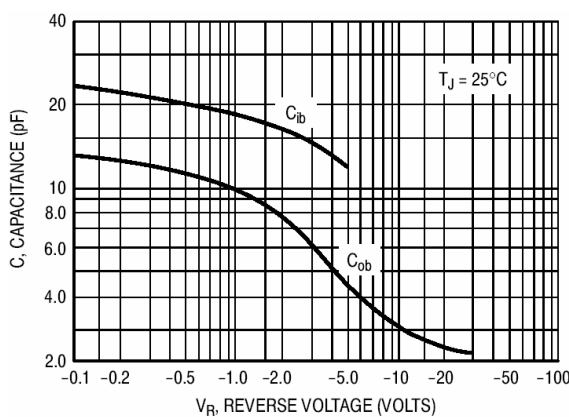

Fig 5. Capacitances

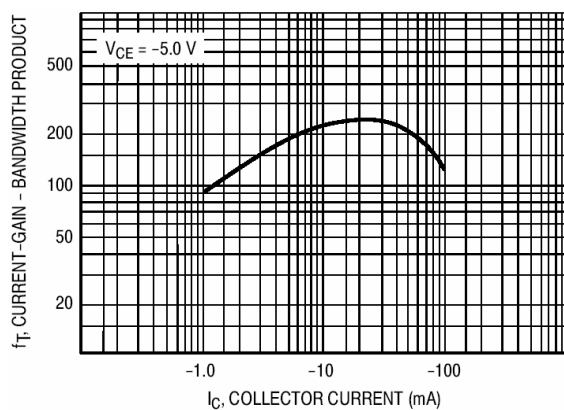

Fig 6. Bandwidth Product

Important Notice:

- All rights are reserved. Reproduction in whole or in part is prohibited without the prior written approval of GTM.
- GTM reserves the right to make changes to its products without notice.
- GTM semiconductor products are not warranted to be suitable for use in life-support Applications, or systems.
- GTM assumes no liability for any consequence of customer product design, infringement of patents, or application assistance.

Head Office And Factory:

- **Taiwan:** No. 17-1 Tatung Rd. Fu Kou Hsin-Chu Industrial Park, Hsin-Chu, Taiwan, R. O. C.
- TEL: 886-3-597-7061 FAX: 886-3-597-9220, 597-0785
- **China:** (201203) No.255, Jang-Jiang Tsai-Lueng RD. , Pu-Dung-Hsin District, Shang-Hai City, China
- TEL: 86-21-5895-7671 ~ 4 FAX: 86-21-38950165