

### Typical Applications

The HMC740ST89E is ideal for:

- Cellular/3G & WiMAX/4G
- Fixed Wireless & WLAN
- CATV, Cable Modem & DBS
- Microwave Radio & Test Equipment
- IF & RF Applications

### Features

- P1dB Output Power: +18 dBm
- Gain: 15 dB
- Output IP3: +40 dBm
- Cascadable 50 Ohm I/Os
- Single Supply: +5V
- Industry Standard SOT89 Package
- Robust 1000V ESD, Class 1C
- Stable Current Over Temperature
- Active Bias Network

### Functional Diagram

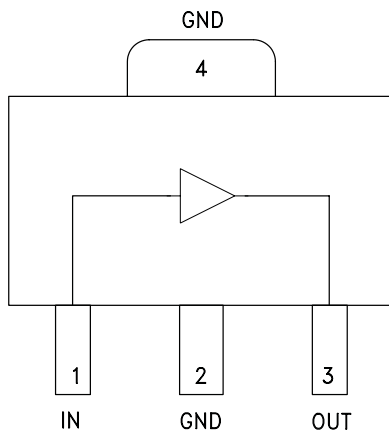

### General Description

The HMC740ST89E is an InGaP Heterojunction Bipolar Transistor (HBT) Gain Block MMIC SMT amplifier covering 0.05 to 3 GHz. Packaged in an industry standard SOT89, the amplifier can be used as a cascadable 50 Ohm RF or IF gain stage as well as a PA or LO driver with up to +18 dBm output power. The HMC740ST89E offers 15 dB of gain with a +40 dBm output IP3 at 100 MHz, and can operate directly from a +5V supply. The HMC740ST89E exhibits excellent gain and output power stability over temperature, while requiring a minimal number of external bias components.

### Electrical Specifications, $V_{cc} = 5V$ , $T_A = +25^\circ C$

Parameter	Min.	Typ.	Max.	Min.	Typ.	Max.	Units
Frequency Range	0.05 - 1			0.05 - 3			GHz
Gain	12	15		11	15		dB
Gain Flatness		$\pm 0.1$			$\pm 0.7$		dB
Gain Variation over Temperature		0.003	0.006		0.003	0.006	dB/°C
Input Return Loss		18			15		dB
Output Return Loss		18			18		dB
Reverse Isolation		20			21		dB
Output Power for 1 dB Compression (P1dB)	15.5	18		14.5	17		dBm
Output Third Order Intercept (IP3) (Pout= 0 dBm per tone, 1 MHz spacing)		38			32		dBm
Noise Figure		3.5			3.5		dB
Supply Current (Icq)		88			88		mA



**InGaP HBT ACTIVE BIAS  
MMIC AMPLIFIER, 0.05 – 3 GHz**

**IF Band Performance**

**Gain & Return Loss**

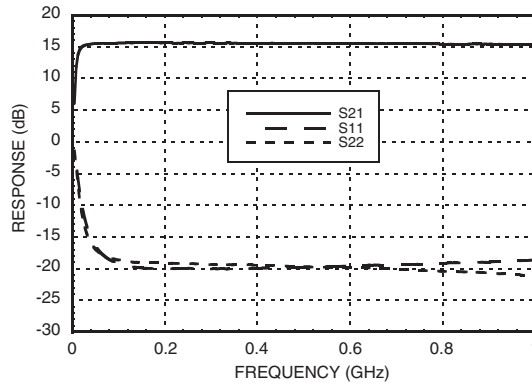

**Gain vs. Temperature**

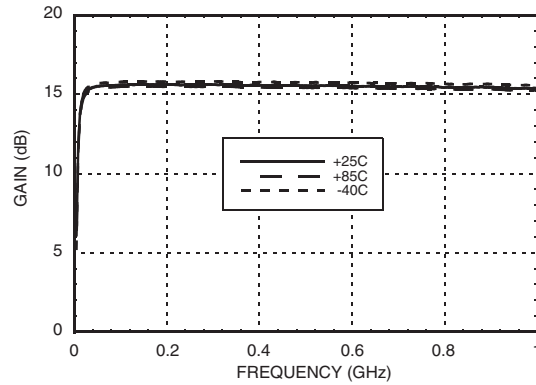

**Noise Figure vs. Temperature**

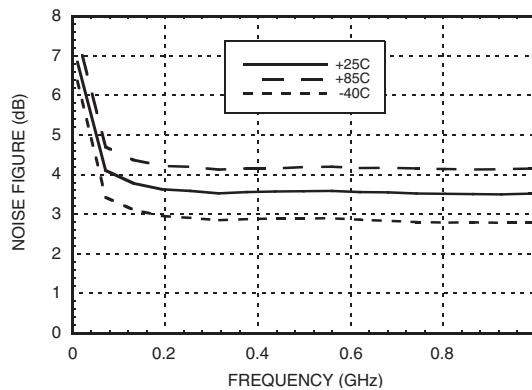

**Output IP3 vs. Temperature**

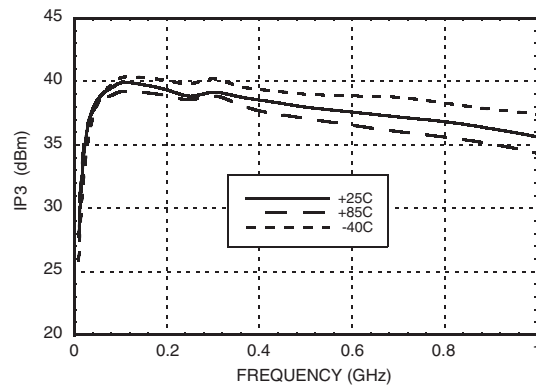

**Output IP3 vs. Vcc**

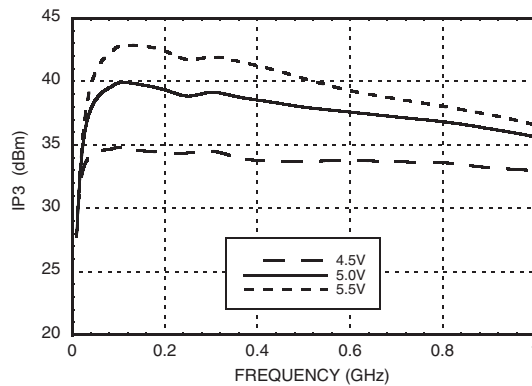

**Output IP3 vs. Output Power**

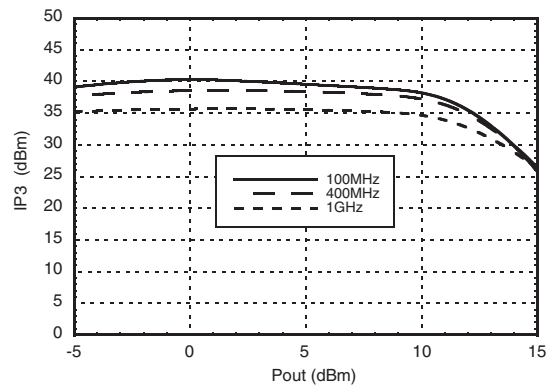



## InGaP HBT ACTIVE BIAS MMIC AMPLIFIER, 0.05 – 3 GHz

### Broadband Performance

**Gain & Return Loss**

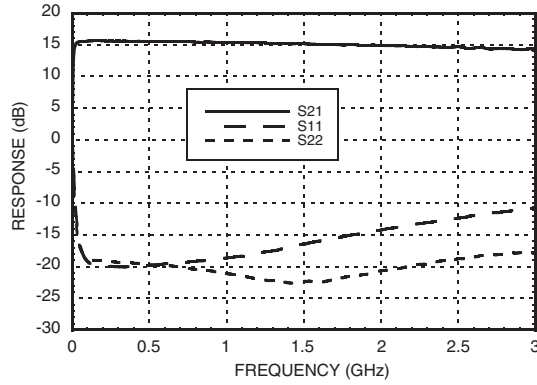

**Gain vs. Temperature**

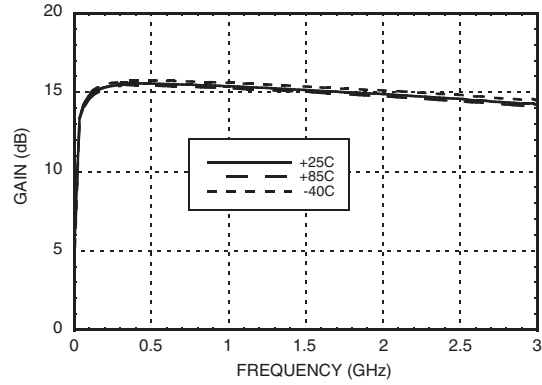

**Gain vs. Vcc**

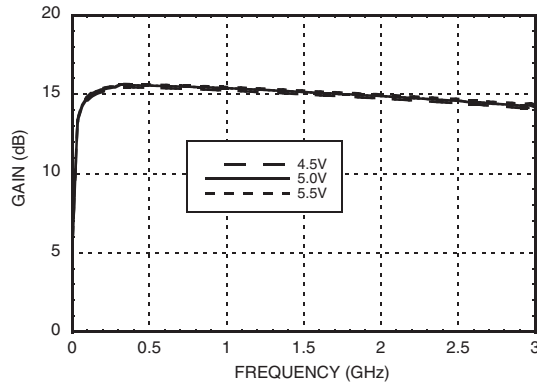

**Input Return Loss vs. Temperature**

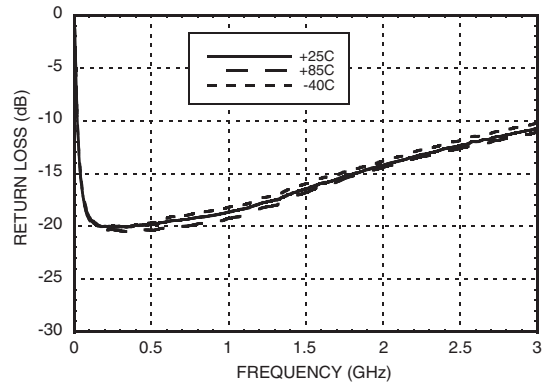

**Output Return Loss vs. Temperature**

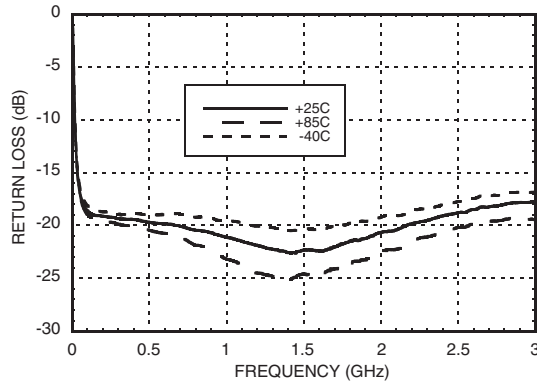

**Input Return Loss vs. Vcc**

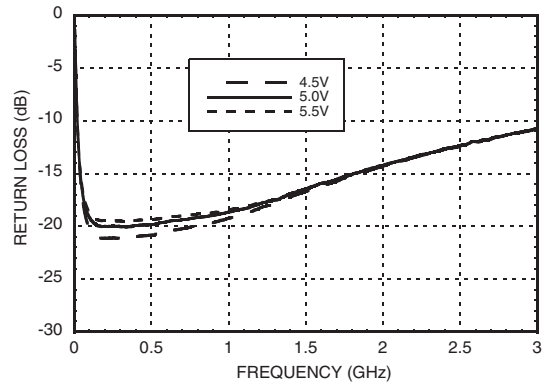



**InGaP HBT ACTIVE BIAS  
MMIC AMPLIFIER, 0.05 – 3 GHz**

**Output Return Loss vs. Vcc**

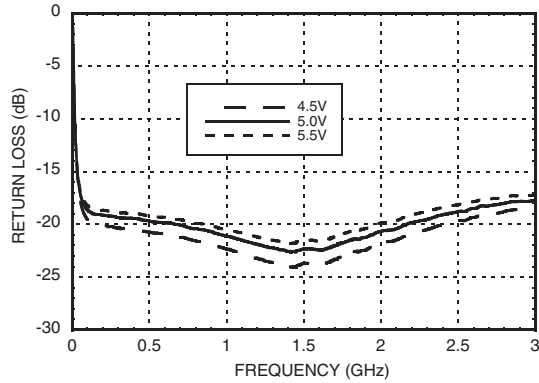

**Noise Figure vs. Temperature**

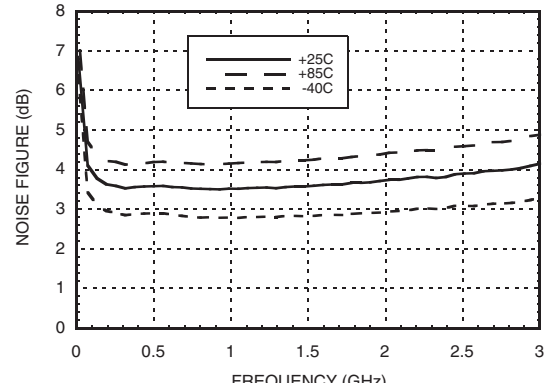

**Noise Figure vs. Vcc**

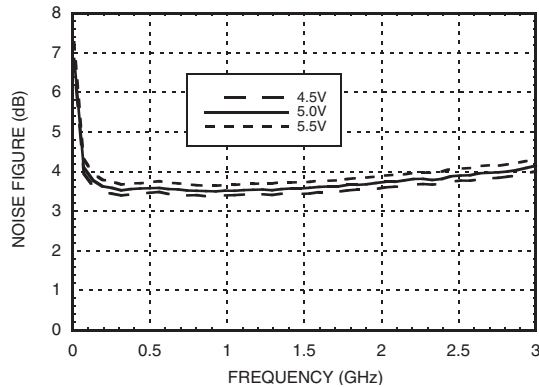

**Reverse Isolation vs. Temperature**

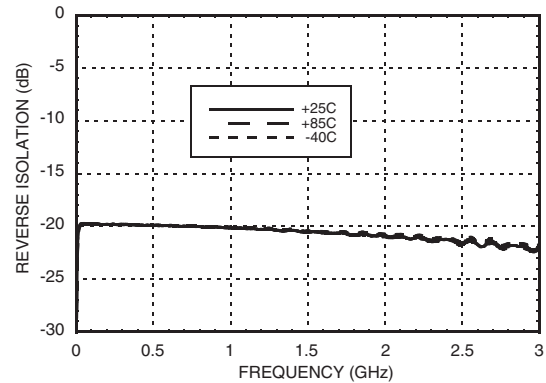

**Reverse Isolation vs. Vcc**

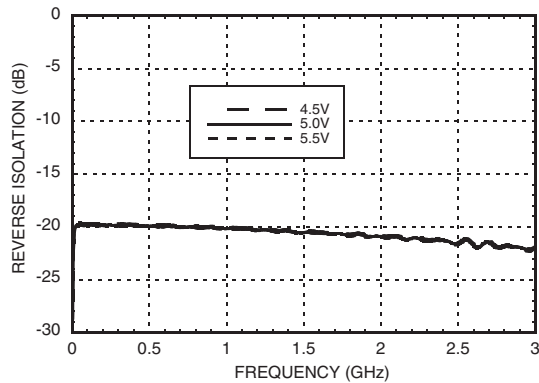

**Output IP3 vs. Temperature**

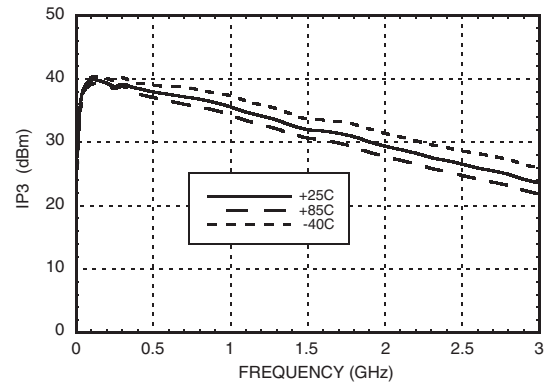

## InGaP HBT ACTIVE BIAS MMIC AMPLIFIER, 0.05 – 3 GHz

**Output IP3 vs. Vcc**

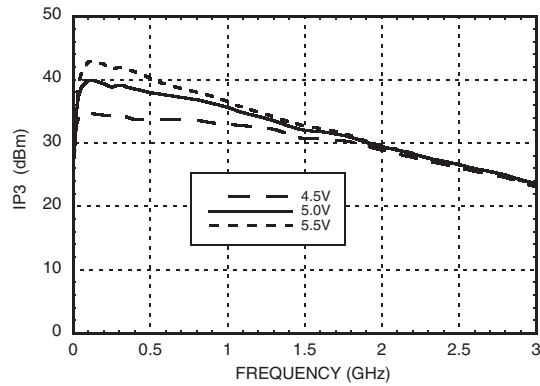

**Current vs. Temperature**

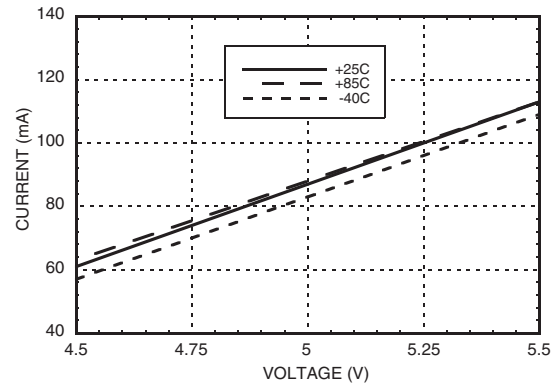

**P1dB vs. Temperature**

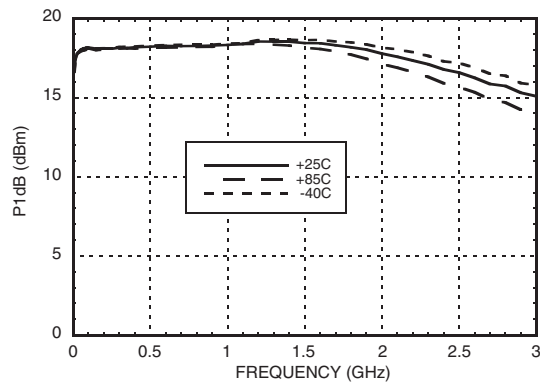

**Psat vs. Temperature**

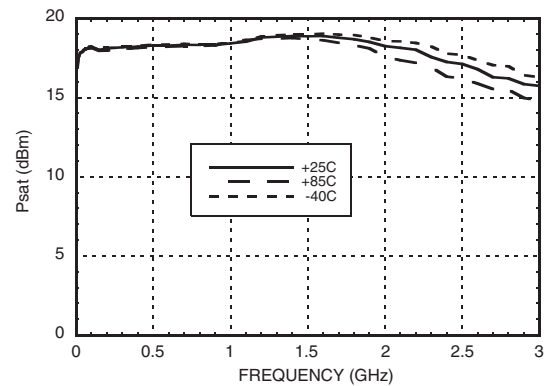

**Power Compression @ 500 MHz**

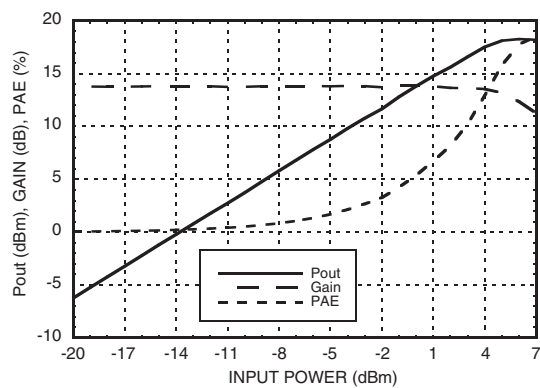

**Power Compression @ 2 GHz**

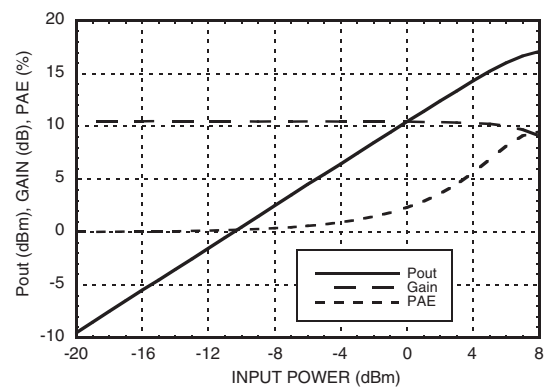

### Absolute Maximum Ratings

Collector Bias Voltage (Vcc)	+5.5 Vdc
RF Input Power (RFIN)	+15 dBm
Junction Temperature	150 °C
Continuous P <sub>diss</sub> (T = 85 °C) (derate 7.14 mW/°C above 85 °C)	0.46 W
Thermal Resistance (junction to lead)	140 °C/W
Storage Temperature	-65 to +150 °C
Operating Temperature	-40 to +85 °C
ESD Sensitivity (HMB)	Class 1C



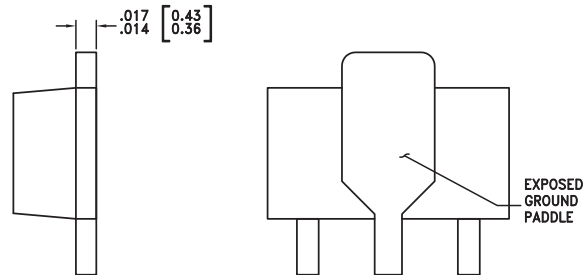
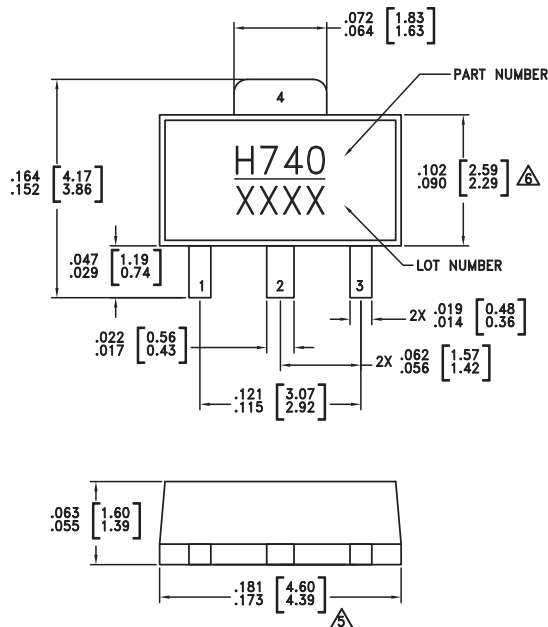

ELECTROSTATIC SENSITIVE DEVICE  
OBSERVE HANDLING PRECAUTIONS

### Outline Drawing



#### NOTES:

- PACKAGE BODY MATERIAL:  
MOLDING COMPOUND MP-180S OR EQUIVALENT.
- LEAD MATERIAL: Cu w/ Ag SPOT PLATING.
- LEAD PLATING: 100% MATTE TIN.
- DIMENSIONS ARE IN INCHES [MILLIMETERS]
-  DIMENSION DOES NOT INCLUDE MOLDFLASH OF 0.15mm PER SIDE.
-  DIMENSION DOES NOT INCLUDE MOLDFLASH OF 0.25mm PER SIDE.
- ALL GROUND LEADS MUST BE SOLDERED TO PCB RF GROUND.



### Package Information

Part Number	Package Body Material	Lead Finish	MSL Rating	Package Marking <sup>[1]</sup>
HMC740ST89E	RoHS-compliant Low Stress Injection Molded Plastic	100% matte Sn	MSL1 <sup>[2]</sup>	H740 XXXX

[1] 4-Digit lot number XXXX

[2] Max peak reflow temperature of 260 °C

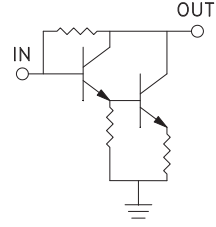
**Pin Descriptions**

Pin Number	Function	Description	Interface Schematic
1	IN	This pin is DC coupled. An off chip DC blocking capacitor is required.	
3	OUT	RF output and DC Bias (Vcc) for the output stage.	
2, 4	GND	These pins and package bottom must be connected to RF/DC ground.	

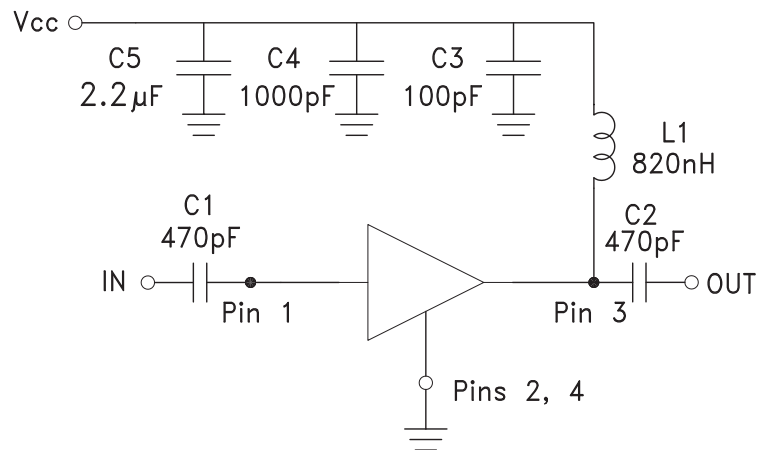
**Application Circuit**

**Evaluation PCB**

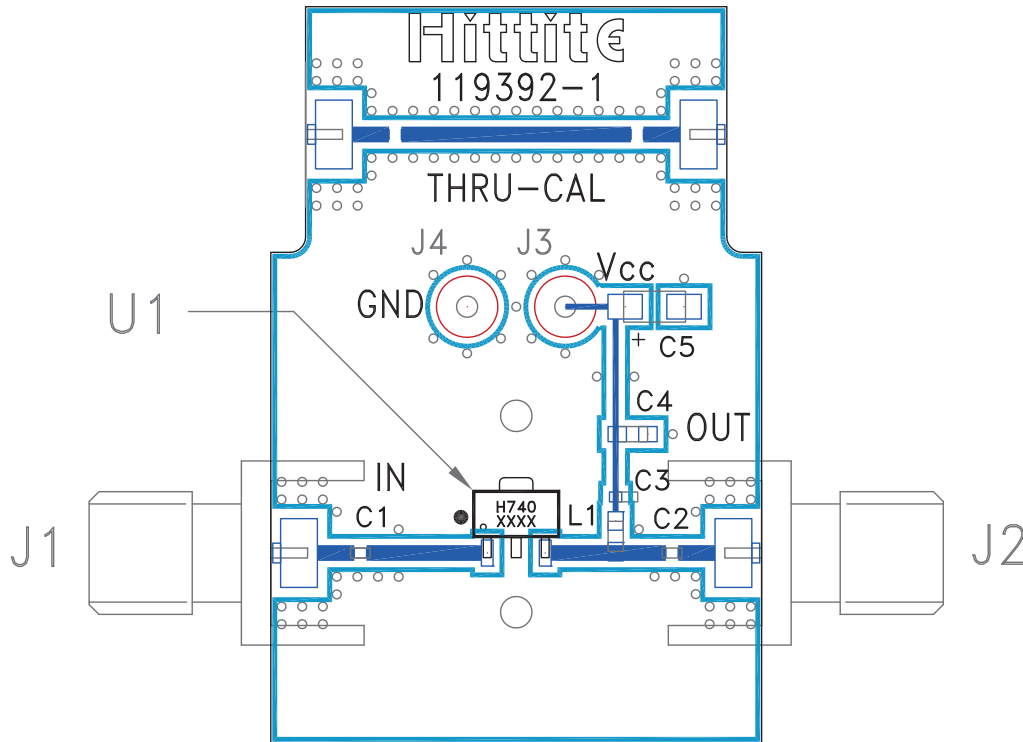

**List of Materials for Evaluation PCB 124390 [1]**

Item	Description
J1, J2	PCB Mount SMA Connector
J3, J4	DC Pin
C1, C2	470 pF Capacitor, 0402 Pkg.
C3	100 pF Capacitor, 0402 Pkg.
C4	1000 pF Capacitor, 0603 Pkg.
C5	2.2 $\mu$ F Capacitor Tantalum
L1	820 nH Inductor, 0603 Pkg.
U1	HMC740ST89E
PCB [2]	119392 Evaluation PCB

[1] Reference this number when ordering complete evaluation PCB

[2] Circuit Board Material: FR4

The circuit board used in the final application should use RF circuit design techniques. Signal lines should have 50 Ohm impedance while the package ground leads and package bottom should be connected directly to the ground plane similar to that shown. A sufficient number of via holes should be used to connect the top and bottom ground planes. The evaluation board should be mounted to an appropriate heat sink. The evaluation circuit board shown is available from Hittite upon request.