

SPECIFICATION FOR LCD MODULE

Model No. TM240128ABCW

Prepared by:	Date:
Checked by :	Date:
Verified by :	Date:
Approved by:	Date:

TIANMA MICROELECTRONICS CO., LTD

REVISION RECORD

Date	Ref. Page	Revision No.	Revision Items	Check & Approval

1. General Specifications:

- 1.1 Display type: STN
- 1.2 Display color*:
 - Display color: Blue-Black
 - Background: Yellow-Green
- 1.3 Polarizer mode: Transflective/Positive
- 1.4 Viewing Angle: 6:00
- 1.5 Driving Method: 1/128 Duty
- 1.6 Backlight: LED
- 1.7 Controller: T6963C
- 1.8 Data Transfer: 8 Bit Parallel
- 1.9 Operating Temperature: -20----+70°C
 - Storage Temperature: -30----+80°C
- 1.10 Outline Dimensions: Refer to outline drawing on next page
- 1.11 Dot Matrix: 240 X 128 Dots
- 1.12 Dot Size: 0.40 X 0.40 (mm)
- 1.13 Dot Pitch: 0.45 X 0.45 (mm)
- 1.14 Weight: 140g

* Color tone is slightly changed by temperature and driving voltage.

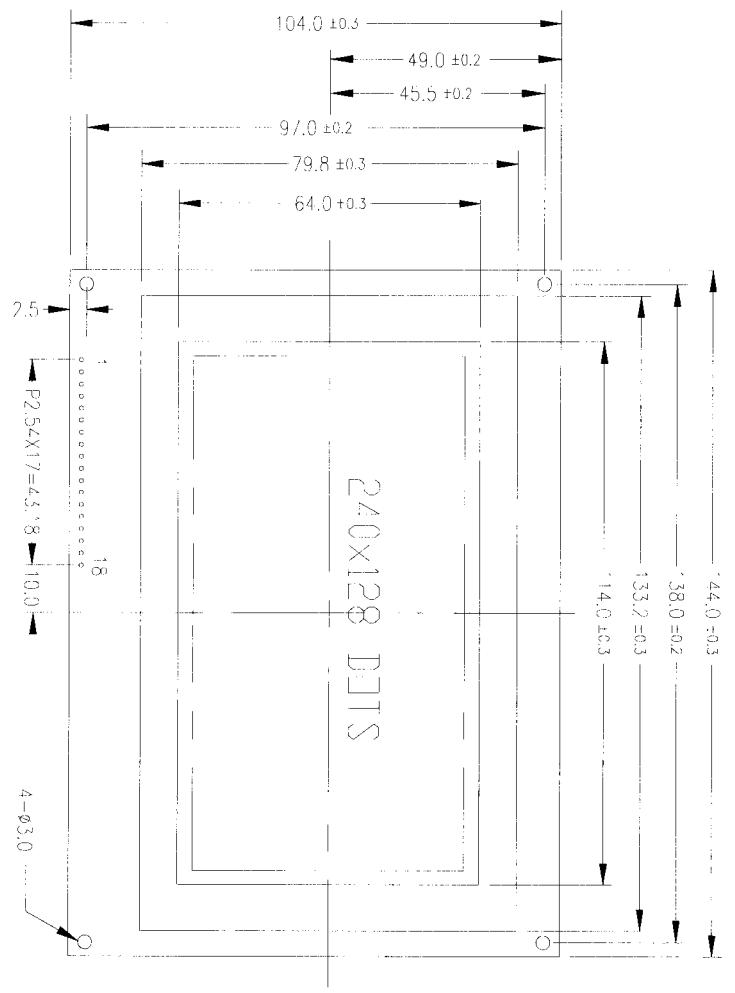

1	2	3	4	5	6	7	8	9	10	11	12	13	14	15	16	17	18
16	30D	VOCT	VO	AMR	RO	CS	C/O	795T	D90	D91	D92	D93	D95	D95T	D96	D97	FS

TYPE	*1	*2
R&EL	5.3	12.0
LD	8.0	15.0

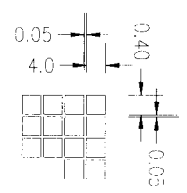
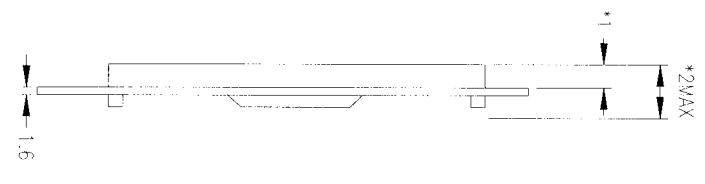

3. LCD Module Part Numbering System

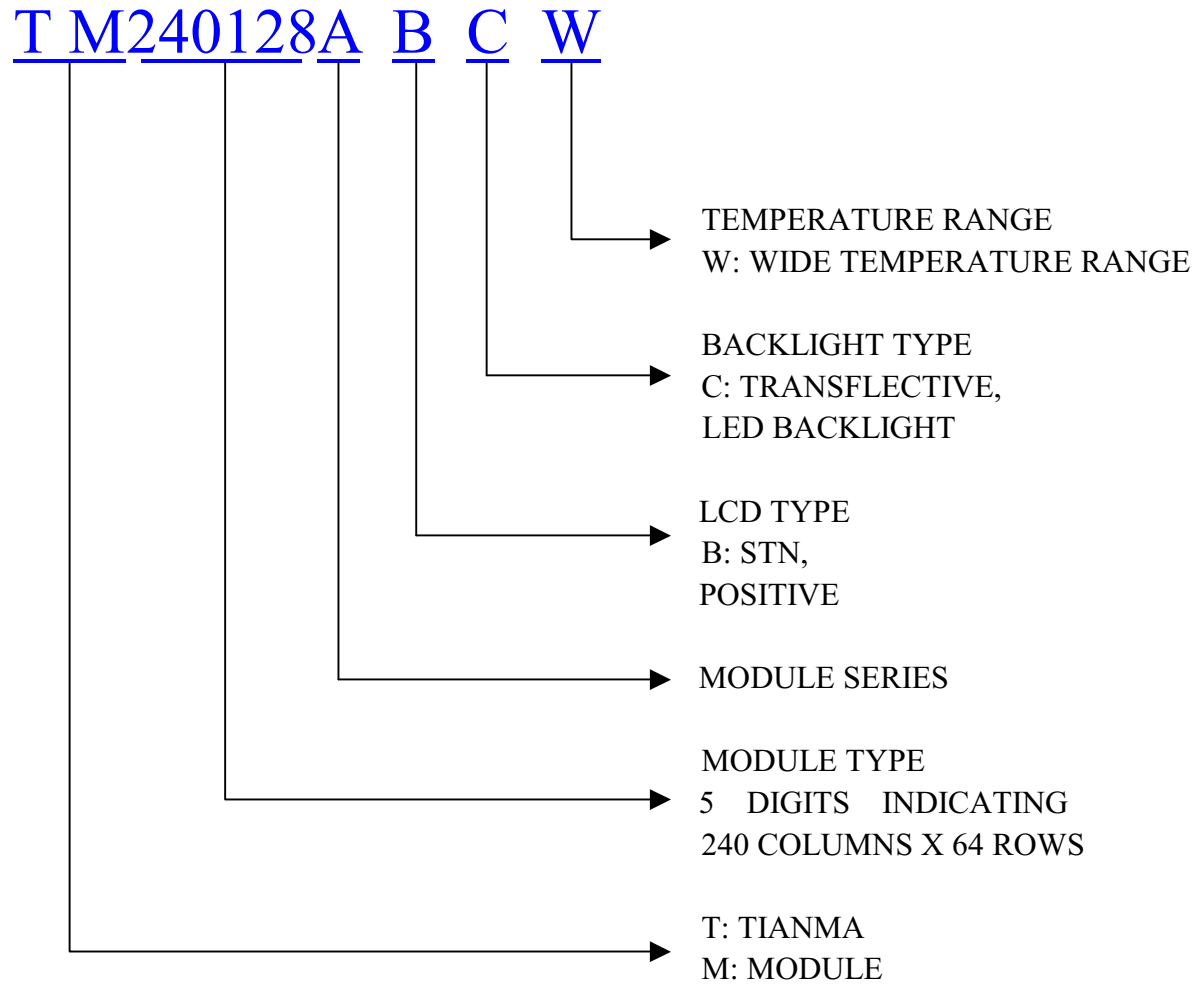

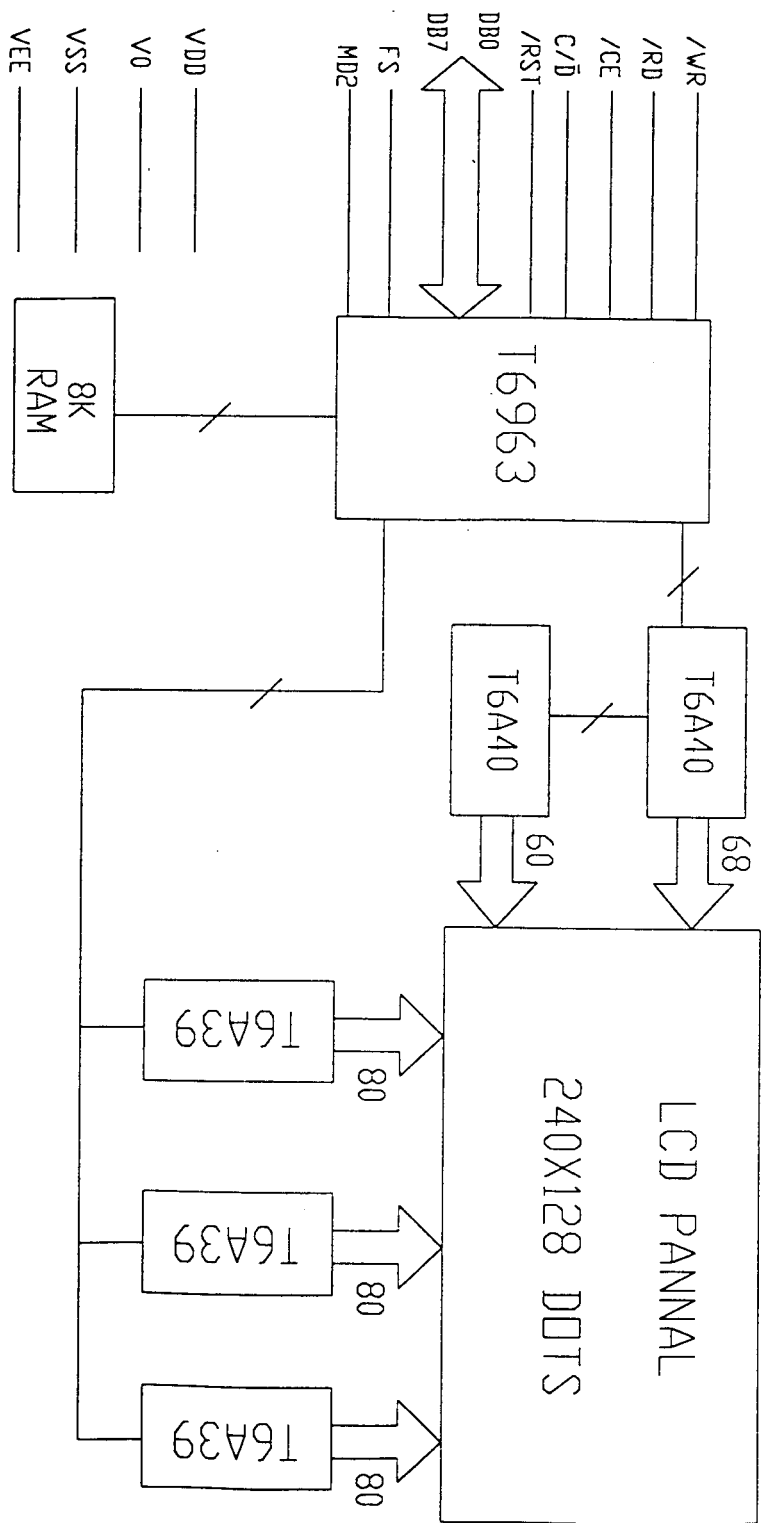

5. Absolute Maximum Ratings

Item	Symbol	Min.	Max.	Unit	Remark
Power Supply Voltage	$V_{DD}-V_{SS}$	0	6.5	V	
LCD Driving Voltage	V_{LCD}	-	18.0		
Operating Temperature Range	T_{OP}	-20	+70	°C	No Condensation
Storage Temperature Range	T_{ST}	-30	+80		

6. Electrical Specifications and Instruction Code

6.1 Electrical characteristics

Item	Symbol	Min.	Typ.	Max.	Unit
Supply Voltage (Logic)	$V_{DD}-V_{SS}$	4.75	5.0	5.25	V
Supply Voltage (LCD Drive)	V_{LCD}	-	15.0	-	V
Input Signal Voltage	High V_{IH} ($V_{DD}=5.0$)	$0.7V_{DD}$	-	$V_{DD}+0.3$	V
	Low V_{IL} ($V_{DD}=5.0$)	0	-	$0.3V_{DD}$	V
Supply current (Logic)	I_{DD} ($V_{DD}-V_{SS}=5.0V$)	-	12.0	-	mA
Supply current (LCD Drive)	I_{EE}	-	5.0	-	mA
Supply current (LED)	I	-	-	280	mA

6.2 Interface Signals

Pin No.	Symbol	Level	Description
1	FG	0V	Frame Ground
2	Vss	0V	Ground
3	Vcc	5.0V	Power supply voltage for logic and LCD(+)
4	Vo	--	Operating Voltage for LCD(-)(variable)
5	$\overline{\text{WR}}$	L	Write Enable Signal
6	$\overline{\text{RD}}$	L	Read Enable Signal
7	$\overline{\text{CE}}$	L	Chip Enable Signal
8	$\overline{\text{C/D}}$	H/L	H:Instruction;L:Data
9	$\overline{\text{RST}}$	L	Reset Signal
10	DB0	H/L	Data bit0
11	DB1	H/L	Data bit1
12	DB2	H/L	Data bit2
13	DB3	H/L	Data bit3
14	DB4	H/L	Data bit4
15	DB5	H/L	Data bit5
16	DB6	H/L	Data bit6
17	DB7	H/L	Data bit7
18	FS	H/L	Font Selection
19	A	LED	Power Supply for LED (+)
20	K	LED	Power Supply for LED (-)

6.3 Interface Timing Chart

Bus Timing

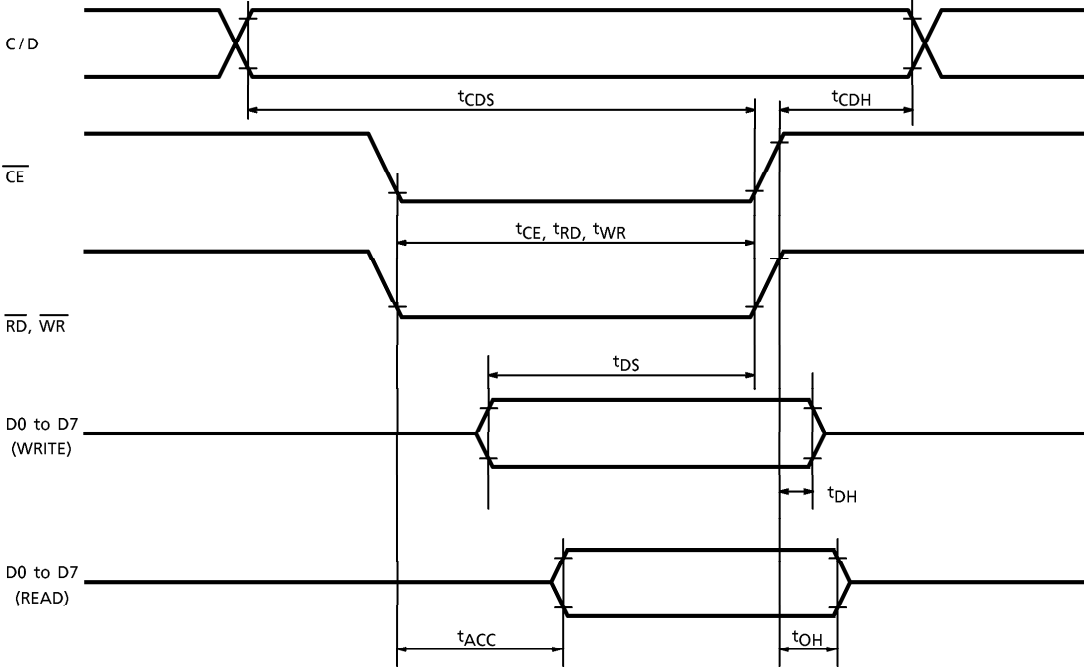

TEST CONDITIONS (Unless otherwise noted, $V_{DD} = 5.0V \pm 10\%$, $V_{SS} = 0V$, $T_a = -20$ to $75^\circ C$)

ITEM	SYMBOL	TEST CONDITIONS	MIN	MAX	UNIT
C/D Set-up Time	t_{CDS}	—	100	—	ns
C/D Hold Time	t_{CDH}	—	10	—	ns
\overline{CE} , \overline{RD} , \overline{WR} Pulse Width	t_{CE} , t_{RD} , t_{WR}	—	80	—	ns
Data Set-up Time	t_{DS}	—	80	—	ns
Data Hold Time	t_{DH}	—	40	—	ns
Access Time	t_{ACC}	—	—	150	ns
Output Hold Time	t_{OH}	—	10	50	ns

6.4 Instruction Code

COMMAND	CODE	D1	D2	FUNCTION
REGISTERS SETTING	00100001	X address	Y address	Set Cursor Pointer
	00100010	Data	00H	Set Offset Register
	00100100	Low address	High address	Set Address Pointer
SET CONTROL WORD	01000000	Low address	High address	Set Text Home Address
	01000001	Columns	00H	Set Text Area
	01000010	Low address	High address	Set Graphic Home Address
	01000011	Columns	00H	SetGraphic Area
MODE SET	1000X000	--	--	OR mode
	1000X001	--	--	EXOR mode
	1000X011	--	--	AND mode
	1000X100	--	--	Text Attribute mode
	10000XXX	--	--	Internal CG ROM mode
	10001XXX	--	--	External CG RAM mode
DISPLAY MODE	10010000	--	--	Display off
	1001XX10	--	--	Cursor on, blink off
	1001XX11	--	--	Cursor on, blink on
	100101XX	--	--	Text on, graphic off
	100110XX	--	--	Text off, graphic on
	100111XX	--	--	Text on, graphic on
CURSOR PATTERN SELECT	10100000	--	--	1-line cursor
	10100001	--	--	2-line cursor
	10100010	--	--	3-line cursor
	10100011	--	--	4-line cursor
	10100100	--	--	5-line cursor
	10100101	--	--	6-line cursor
	10100110	--	--	7-line cursor
	10100111	--	--	8-line cursor
DATAAUTO READ/WRITE	10110000	--	--	Set Data Auto Write
	10110001	--	--	Set Data Auto Read
	10110010	--	--	Set Reset
DATA READ/WRITE	11000000	Data	--	Data Write and increment ADP
	11000001	--	--	Data Read and increment ADP
	11000010	Data	--	Data Write and Decrement ADP
	11000011	--	--	Data Read and Decrement ADP
	11000100	Data	--	Data Write and Nonvariable ADP
	11000101	--	--	Data Read and Nonvariable ADP
SCREEN PEEK	11100000	--	--	Screen Peek
SCREEN COPY	11101000			Screen Copy
BIT SET/RESET	11110XXX	--	--	bit reset
	11111XXX	--	--	bit set
	1111X000	--	--	bit0(LSB)
	1111X001	--	--	bit1
	1111X010	--	--	bit2
	1111X011	--	--	bit3
	1111X100	--	--	bit4
	1111X101	--	--	bit5
	1111X110	--	--	bit6
	1111X111	--	--	bit7(MSB)

X:invalid

6.5 Character code map (ROM code 0101)

LSB MSB	0	1	2	3	4	5	6	7	8	9	A	B	C	D	E	F
0		!	"	#	\$	%	&	'	()	*	+	,	-	.	/
1	0	1	2	3	4	5	6	7	8	9	:	;	<	=	>	?
2	a	b	c	d	e	f	g	h	i	j	k	l	m	n	o	
3	p	q	r	s	t	u	v	w	x	y	z	[\]	^	_
4	\	a	b	c	d	e	f	g	h	i	j	k	l	m	n	o
5	p	q	r	s	t	u	v	w	x	y	z	{		}	~	
6	ÿ	ü	û	ù	ú	û	ü	ý	è	é	ê	ë	ì	í	î	ï
7	ê	ë	ì	í	î	ï	ò	ó	ô	õ	ö	ø	å	æ	ç	š

7. Optical Characteristics

7.1 Optical Characteristics

Ta=25°C

Item	Symbol	Condition	Min.	Typ.	Max.	Unit	
Viewing Angle	θ_x	$C_r \geq 2$	$\theta_y = 0^\circ$	-2.0	--	30	Deg
	θ_y						
Contrast Ratio	C_r	$\theta_x = 0^\circ$ $\theta_y = 0^\circ$	3.0	-	-		
Response Time	Turn on	$\theta_x = 0^\circ$ $\theta_y = 0^\circ$	-	-	300	ms	
	Turn off						300

7.2 Definition of Optical Characteristics

7.2.1 Definition of Viewing Angle

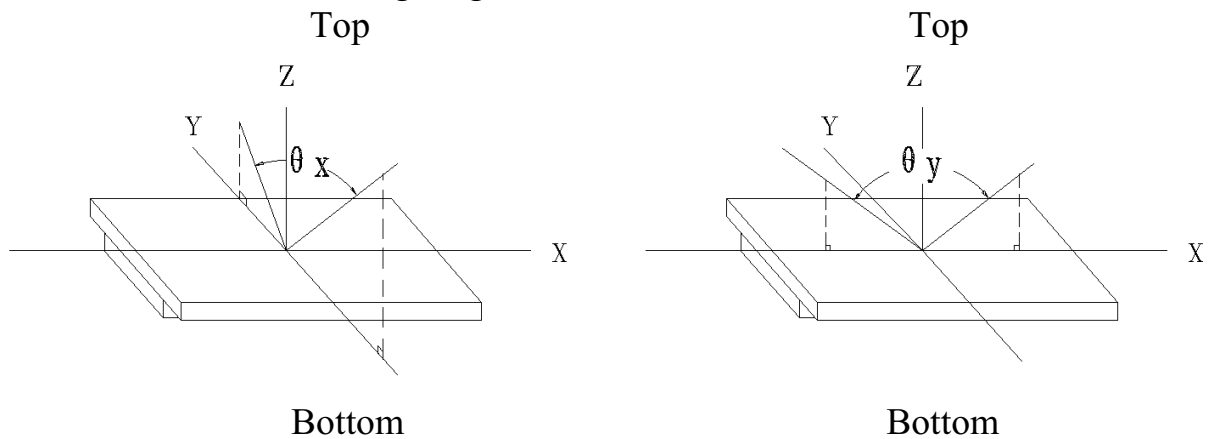

7.2.2 Definition of Contrast Ratio

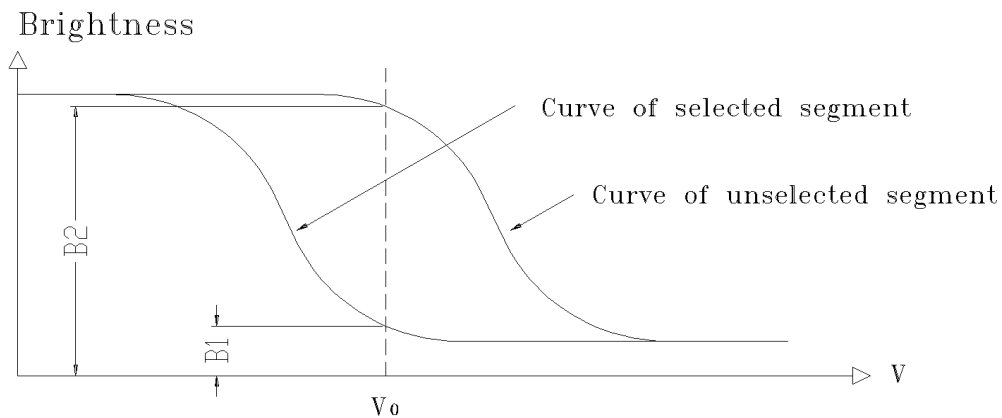

$$\text{Contrast Ratio} = B2/B1 = \frac{\text{unselected state brightness}}{\text{selected state brightness}}$$

Measuring Conditions:

- 1) Ambient Temperature: 25°C ;
- 2) Frame frequency: 64Hz

7.2.3 Definition of Response time

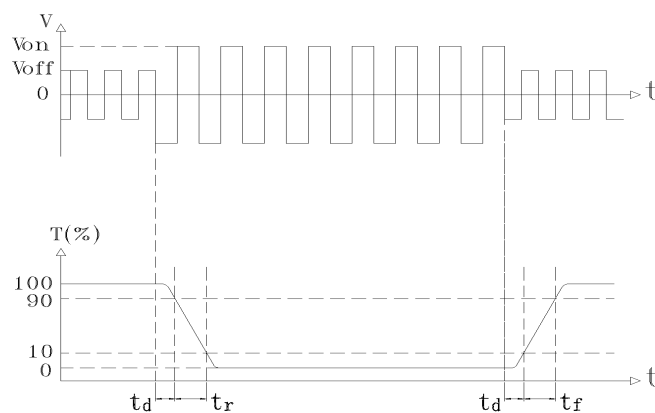

Turn on time: $t_{on} = t_d + t_r$ Turn off time: $t_{off} = t_d + t_f$

Measuring Condition:

- 1) Operating Voltage: 11.0V
- 2) Frame frequency: 64Hz

8. Reliability

8.1 Content of Reliability Test

Ta=25°C

No.	Test Item	Content of Test	Test condition
1	High Temperature Storage	Endurance test applying the high storage temperature for a long time	80°C 240H
2	Low Temperature Storage	Endurance test applying the low storage temperature for a long time	-30°C 240H
3	High Temperature Operation	Endurance test applying the electric stress (voltage & current) and the thermal stress to the element for a long time	70°C 240H
4	Low Temperature Operation	Endurance test applying the electric stress under low temperature for a long time	-20°C 240H
5	High Temperature /Humidity Storage	Endurance test applying the high temperature and high humidity storage for a long time	60°C 95%RH 240H
6	Temperature Cycle	Endurance test applying the low and high temperature cycle $-30^{\circ}\text{C} \longleftrightarrow 25^{\circ}\text{C} \longleftrightarrow 80^{\circ}\text{C} \longleftrightarrow 25^{\circ}\text{C}$ $\begin{array}{cccc} 30\text{min} & 5\text{min} & 30\text{min} & 5\text{min} \end{array}$ <p style="text-align: center;">←————— 1 cycle —————→</p>	-30°C/80°C 10 cycles
7	Vibration Test (package state)	Endurance test applying the vibration during transportation	10Hz~500Hz, 100m/s ² , 120min
8	Shock Test (package state)	Endurance test applying the shock during transportation	Half- sine wave, 300m/s ² , 18ms
9	Atmospheric Pressure Test	Endurance test applying the atmospheric pressure during transportation by air	25kPa 16H

8.2 Failure Judgment Criterion

Criterion Item	Test Item No.									Failure Judgement Criterion
	1	2	3	4	5	6	7	8	9	
Basic Specification	√	√	√	√	√	√	√	√	√	Out of the basic Specification
Electrical specification	√	√	√	√	√					Out of the electrical specification
Mechanical Specification							√	√		Out of the mechanical specification
Optical Characteristic	√	√	√	√	√	√			√	Out of the optical specification
Note	For test item refer to 8.1									
Remark	Basic specification = Optical specification + Mechanical specification									

9. QUALITY LEVEL

Examination or Test	At $T_a=25^\circ\text{C}$ (unless otherwise stated)	Inspection				
		Min.	Max.	Unit	IL	AQL
External Visual Inspection	Under normal illumination and eyesight condition, the distance between eyes and LCD is 25cm.	See Appendix A			II	Major 1.0 Minor 2.5
Display Defects	Under normal illumination and eyesight condition, display on inspection.	See Appendix B			II	Major 1.0 Minor 2.5
Note: Major defects: Open segment or common, Short, Serious damages, Leakage Miner defects: Others Sampling standard conforms to GB2828						

10. Precautions for Use of LCD Modules

10.1 Handling Precautions

10.1.1 The display panel is made of glass. Do not subject it to a mechanical shock by dropping it from a high place, etc.

10.1.2 If the display panel is damaged and the liquid crystal substance inside it leaks out, be sure not to get any in your mouth, if the substance comes into contact with your skin or clothes, promptly wash it off using soap and water.

10.1.3 Do not apply excessive force to the display surface or the adjoining areas since this may cause the color tone to vary.

10.1.4 The polarizer covering the display surface of the LCD module is soft and easily scratched. Handle this polarizer carefully.

10.1.5 If the display surface is contaminated, breathe on the surface and gently wipe it with a soft dry cloth. If still not completely clear, moisten cloth with one of the following solvents:

- Isopropyl alcohol
- Ethyl alcohol

Solvents other than those mentioned above may damage the polarizer.

Especially, do not use the following:

- Water
- Ketone
- Aromatic solvents

10.1.6 Do not attempt to disassemble the LCD Module.

10.1.7 If the logic circuit power is off, do not apply the input signals.

10.1.8 To prevent destruction of the elements by static electricity, be careful to maintain an optimum work environment.

- a. Be sure to ground the body when handling the LCD Modules.
- b. Tools required for assembly, such as soldering irons, must be properly ground.
- c. To reduce the amount of static electricity generated, do not conduct assembly and other work under dry conditions.
- d. The LCD Module is coated with a film to protect the display surface. Be care when peeling off this protective film since static electricity may be generated.

10.2 Storage precautions

10.2.1 When storing the LCD modules, avoid exposure to direct sunlight or to the light of fluorescent lamps.

10.2.2 The LCD modules should be stored under the storage temperature range. If the LCD modules will be stored for a long time, the recommend condition is:

Temperature : $0^{\circ}\text{C} \sim 40^{\circ}\text{C}$

Relatively humidity: $\leq 80\%$

10.2.3 The LCD modules should be stored in the room without acid, alkali and harmful gas.

10.3 The LCD modules should be no falling and violent shocking during transportation, and also should avoid excessive press, water, damp and sunshine.

Appendix A

Inspection items and criteria for appearance defects

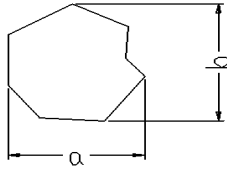
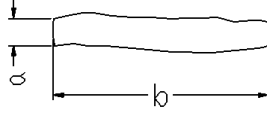
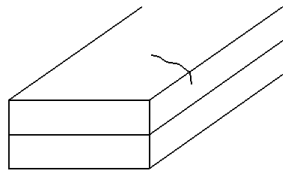
Items	Contents	Criteria			
Leakage		Not permitted			
Rainbow		According to the limit specimen			
Polarizer	Wrong polarizer attachment	Not permitted			
	Bubble between polarizer and glass	Not counted	Max. 3 defects allowed		
		$\phi < 0.3\text{mm}$	$0.3\text{mm} \leq \phi \leq 0.5\text{mm}$		
	Scratches of polarizer	According to the limit specimen			
Black spot (in viewing area)		Not counted	Max. 3 spots allowed	Max. 3 spots (lines) allowed	
		$X < 0.2\text{mm}$	$0.2\text{mm} \leq X \leq 0.5\text{mm}$		
		$X = (a+b)/2$			
Black line (in viewing area)		Not counted	Max. 3 lines allowed		
		$a < 0.02\text{mm}$	$0.02\text{mm} \leq a \leq 0.05\text{mm}$ $b \leq 2.0\text{mm}$		
Progressive cracks		Not permitted			

Appendix B

Inspection items and criteria for display defects

Items	Contents	Criteria		
Open segment or open common		Not permitted		
Short		Not permitted		
Wrong viewing angle		Not permitted		
Contrast ratio uneven		According to the limit specimen		
Crosstalk		According to the limit specimen		
Pin holes and cracks in segment (DOT)		Not counted	Max.3 dots allowed	Max.3 dots allowed
		$X < 0.1\text{mm}$	$0.1\text{mm} \leq X \leq 0.2\text{mm}$	
		$X = (a+b)/2$		Max.3 dots allowed
		Not counted	Max.2 dots allowed	
Black spot (in viewing area)		$A < 0.1\text{mm}$	$0.1\text{mm} \leq A \leq 0.2\text{mm}$	Max.3 spots (lines) allowed
		$D < 0.25\text{mm}$		
Black line (in viewing area)		Not counted	Max.3 spots allowed	Max.3 spots (lines) allowed
		$X < 0.1\text{mm}$	$0.1\text{mm} \leq X \leq 0.2\text{mm}$	
		$X = (a+b)/2$		Max.3 spots (lines) allowed
		Not counted	Max.3 lines allowed	
		$a < 0.02\text{mm}$	$0.02\text{mm} \leq a \leq 0.05\text{mm}$	Max.3 lines allowed
		$b \leq 0.5\text{mm}$		

Appendix B

Inspection items and criteria for display defects (continued)

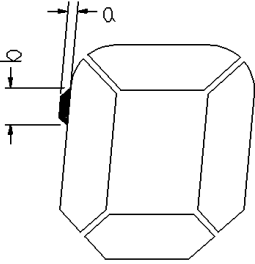
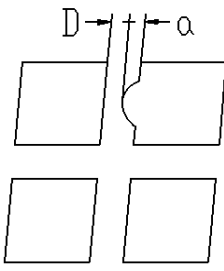
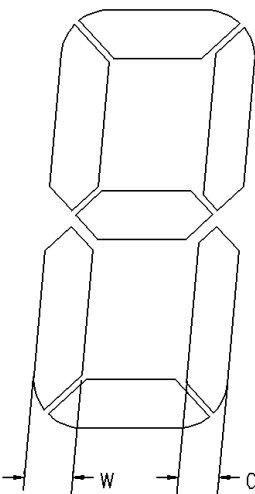
Items	Content	Criteria				
Transformation of segment		Not counted	Max. 2 defects allowed	Max.3 defects allowed		
		$x < 0.1\text{mm}$	$0.1\text{mm} \leq x \leq 0.2\text{mm}$			
		$x = (a+b)/2$				
		Not counted	Max. 1 defects allowed			
		$a < 0.1\text{mm}$	$0.1\text{mm} \leq a \leq 0.2\text{mm}$ $D > 0$			
		Max.2 defects allowed $0.8W \leq a \leq 1.2W$ $a = \text{measured value of width}$ $W = \text{nominal value of width}$				