

9000h at 105°C

- Extended Lifetime at 105°C
- High Ripple Current
- High Professional Industrial Power Supplies

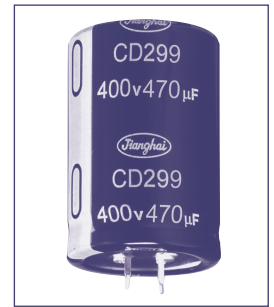
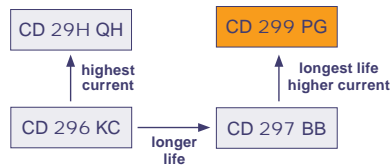

| Item  | Characteristics  |   |
|---|--|---|
| Operating Temperature Range (°C)                        | -40 ~ +105   | -25 ~ +105                                    |
| Voltage Range (V)                                       | 160 ~ 250  | 315 ~ 450                                     |
| Capacitance Range (µF)                                  | 39 ~ 2200  |   |
| Capacitance Tolerance (20°C, 120Hz)                     | ± 20%  |   |
| Leakage Current (µA)                                    | After 5 minutes at 20°C application of rated voltage, leakage current is not more than 0,01CV or 1,5mA, whichever is smaller<br>C: Nominal Capacitance (µF) V: Rated Voltage (V) |   |
| Dissipation Factor (20°C, 120Hz)                        | Rated Voltage (V)  | 160   180   200   250   315   350   400   450 |
|   | Tan δ (max)  | 0,15   0,20                                   |
| Stability at Low Temperature (Impedance Ratio at 120Hz) | Rated Voltage (V)  | ≤ 250   315 ~ 450                             |
|   | Z <sub>-25°C</sub> / Z <sub>+20°C</sub>  | 3   8   |
|   | Z <sub>-40°C</sub> / Z <sub>+20°C</sub>  | 12   -  |

|   | Useful Life  |   | Load Life   | Endurance Test                                | Shelf Life  |
|---|--|---|---|---|---|
| Lifetime  | 9000h  | >200000h  | 7000h   | 7000h   | 1000h   |
| Leakage Current   | Not more than specified value                                  |   | Not more than specified value                           | Not more than specified value                 | Not more than specified value   |
| Capacity Change   | Within ± 30% of initial value                                  |   | Within ± 20% of initial value                           | Within ± 20% of initial value                 | Within ± 20% of initial value   |
| Dissipation Factor  | Not more than 300% of specified value                          |   | Not more than 200% of specified value                   | Not more than 130% of specified value         | Not more than 200% of specified value   |
| Condition:<br>Applied Voltage<br>Applied Current<br>Applied Temperature<br>Failure Rate Level | U <sub>R</sub><br>I <sub>R</sub><br>105°C<br>≤ 1% Failure Rate | U <sub>R</sub><br>1,4 x I <sub>R</sub><br>50°C<br>≤ 1% Failure Rate | U <sub>R</sub><br>I <sub>R</sub><br>105°C<br>guaranteed | U <sub>R</sub><br>I <sub>R</sub> = 0<br>105°C | U <sub>R</sub> = 0<br>I <sub>R</sub> = 0<br>105°C<br>After test:<br>U <sub>R</sub> to be applied<br>for 30min<br>>24h before<br>measurement |

## Multiplier for Ripple Current

Frequency Coefficient

| Rated Voltage (V) | Frequency |      |       |       |      |        |
|-------------------|-----------|------|-------|-------|------|--------|
|                   | 50Hz      | 60Hz | 120Hz | 300Hz | 1kHz | ≥50kHz |
| 160 ~ 250         | 0,81      | 0,85 | 1,00  | 1,17  | 1,45 | 1,50   |
| 315 ~ 450         | 0,77      | 0,82 | 1,00  | 1,16  | 1,41 | 1,43   |

Lifetime Diagram

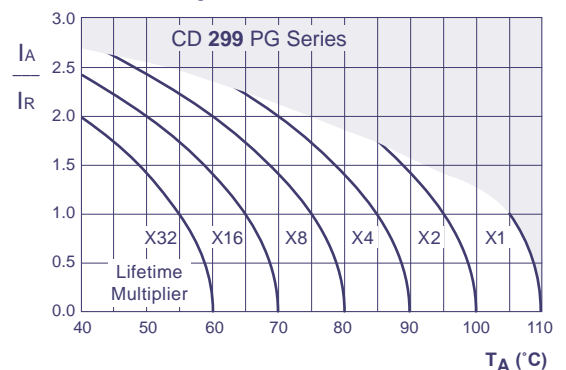

I<sub>A</sub> = actual ripple current at 120Hz, I<sub>R</sub> = rated ripple current at 120Hz, 105°C  
Multiplier of Useful Life as a function of ambient temperature and ripple current load

## Ratings for CD 299 PG Series

| V <sub>DC</sub><br>(Surge<br>Voltage)<br>Code | Rated<br>Capa-<br>cance | Max ESR<br>20°C,<br>120Hz | Typ ESR<br>20°C,<br>120Hz | Max<br>Ripple<br>Current<br>105°C,<br>120Hz | Size<br>Ø<br>D x L |
|---|-------------------------|---------------------------|---------------------------|---|--------------------|
| (V)   | (µF)                    | (mΩ)                      | (mΩ)                      | (Arms)                                      | (mm)               |
| <b>160<br/>(200)<br/>2C</b>                   | 270                     | 737                       | 516                       | 1,10  | 22 x 25            |
|   | 330                     | 603                       | 423                       | 1,20  | 22 x 30            |
|   | 390                     | 511                       | 358                       | 1,30  | 25 x 25            |
|   | 470                     | 424                       | 297                       | 1,40  | 22 x 35            |
|   |                         | 424                       | 297                       | 1,40  | 25 x 30            |
|   | 560                     | 356                       | 249                       | 1,50  | 22 x 40            |
|   |                         | 356                       | 249                       | 1,50  | 30 x 25            |
|   | 680                     | 293                       | 205                       | 1,70  | 22 x 45            |
|   |                         | 293                       | 205                       | 1,70  | 25 x 35            |
|   |                         | 293                       | 205                       | 1,70  | 30 x 30            |
|   | 820                     | 243                       | 170                       | 2,00  | 25 x 40            |
|   | 1000                    | 199                       | 140                       | 2,20  | 25 x 45            |
|   |                         | 199                       | 140                       | 2,20  | 30 x 35            |
|   | 1200                    | 166                       | 117                       | 2,30  | 25 x 50            |
|   |                         | 166                       | 117                       | 2,30  | 30 x 40            |
|   |                         | 166                       | 117                       | 2,30  | 35 x 35            |
|   | 1500                    | 133                       | 93                        | 2,50  | 30 x 45            |
|   |                         | 133                       | 93                        | 2,50  | 35 x 40            |
| 1800  | 111                     | 78                        | 2,70                      | 30 x 50                                     |                    |
|   | 111                     | 78                        | 2,70                      | 35 x 45                                     |                    |
| 2200  | 91                      | 64                        | 2,90                      | 35 x 50                                     |                    |
| <b>180<br/>(225)<br/>2K</b>                   | 220                     | 905                       | 634                       | 1,00  | 22 x 25            |
|   | 330                     | 603                       | 423                       | 1,20  | 22 x 30            |
|   |                         | 603                       | 423                       | 1,20  | 25 x 25            |
|   | 470                     | 424                       | 297                       | 1,40  | 22 x 35            |
|   |                         | 424                       | 297                       | 1,40  | 25 x 30            |
|   |                         | 424                       | 297                       | 1,40  | 30 x 25            |
|   | 560                     | 356                       | 249                       | 1,50  | 22 x 40            |
|   |                         | 356                       | 249                       | 1,50  | 25 x 35            |
|   | 680                     | 293                       | 205                       | 1,70  | 22 x 50            |
|   |                         | 293                       | 205                       | 1,70  | 25 x 40            |
|   |                         | 293                       | 205                       | 1,70  | 30 x 30            |
|   | 820                     | 243                       | 170                       | 2,00  | 25 x 45            |
|   |                         | 243                       | 170                       | 2,00  | 30 x 35            |
|   |                         | 243                       | 170                       | 2,00  | 35 x 30            |
|   | 1000                    | 199                       | 140                       | 2,20  | 30 x 40            |
|   | 1200                    | 166                       | 117                       | 2,30  | 30 x 45            |
|   |                         | 166                       | 117                       | 2,20  | 35 x 35            |
|   | 1500                    | 133                       | 93                        | 2,50  | 30 x 50            |
| 133   |                         | 93                        | 2,50                      | 35 x 40                                     |                    |
| 1800  | 111                     | 78                        | 2,70                      | 35 x 45                                     |                    |
| 2200  | 91                      | 64                        | 2,90                      | 35 x 50                                     |                    |
| <b>200<br/>(250)<br/>2D</b>                   | 220                     | 905                       | 634                       | 1,00  | 22 x 25            |
|   | 270                     | 737                       | 516                       | 1,10  | 22 x 30            |
|   |                         | 737                       | 516                       | 1,10  | 25 x 25            |
|   | 390                     | 511                       | 358                       | 1,30  | 22 x 35            |
|   |                         | 511                       | 358                       | 1,30  | 25 x 30            |
|   |                         | 511                       | 358                       | 1,30  | 30 x 25            |
|   | 470                     | 424                       | 297                       | 1,40  | 22 x 40            |
|   |                         | 424                       | 297                       | 1,40  | 25 x 35            |
|   |                         | 424                       | 297                       | 1,40  | 30 x 30            |
|   | 560                     | 356                       | 249                       | 1,50  | 22 x 45            |
|   | 680                     | 293                       | 205                       | 1,70  | 25 x 40            |
|   |                         | 293                       | 205                       | 1,70  | 30 x 35            |
|   |                         | 293                       | 205                       | 1,70  | 35 x 30            |
|   | 820                     | 243                       | 170                       | 2,00  | 25 x 50            |
|   |                         | 243                       | 170                       | 2,00  | 30 x 40            |
|   |                         | 243                       | 170                       | 2,00  | 35 x 30            |
|   | 1000                    | 199                       | 140                       | 2,20  | 30 x 45            |
|   | 1200                    | 199                       | 140                       | 2,20  | 35 x 35            |
| 166   |                         | 117                       | 2,30                      | 30 x 50                                     |                    |
| 1500  | 166                     | 117                       | 2,30                      | 35 x 40                                     |                    |
|   | 133                     | 93                        | 2,50                      | 35 x 50                                     |                    |
| 180   | 1106                    | 774                       | 0,90                      | 22 x 30                                     |                    |
| 220   | 905                     | 634                       | 1,00                      | 25 x 25                                     |                    |
| <b>250<br/>(300)<br/>2E</b>                   | 270                     | 737                       | 516                       | 1,10  | 22 x 35            |
|   |                         | 737                       | 516                       | 1,10  | 25 x 30            |
|   |                         | 737                       | 516                       | 1,10  | 30 x 25            |
|   | 330                     | 603                       | 423                       | 1,20  | 22 x 40            |
|   |                         | 603                       | 423                       | 1,20  | 25 x 35            |
|   | 390                     | 511                       | 358                       | 1,30  | 22 x 45            |
|   |                         | 511                       | 358                       | 1,30  | 25 x 40            |
|   |                         | 511                       | 358                       | 1,30  | 30 x 30            |
|   | 470                     | 424                       | 297                       | 1,40  | 25 x 45            |
|   |                         | 424                       | 297                       | 1,40  | 30 x 35            |
|   |                         | 424                       | 297                       | 1,40  | 35 x 30            |
|   | 560                     | 356                       | 249                       | 1,50  | 25 x 50            |
|   | 680                     | 293                       | 205                       | 1,70  | 30 x 45            |
|   |                         | 293                       | 205                       | 1,70  | 35 x 35            |
|   | 820                     | 243                       | 170                       | 2,00  | 30 x 50            |
|   |                         | 243                       | 170                       | 2,00  | 35 x 40            |
|   | 1000                    | 199                       | 140                       | 2,20  | 35 x 45            |
|   | 1200                    | 166                       | 117                       | 2,30  | 35 x 50            |
| <b>315<br/>(365)<br/>2F</b>                   | 82                      | 2427                      | 1335                      | 0,64  | 22 x 25            |
|   | 100                     | 1990                      | 1095                      | 0,69  | 22 x 30            |
|   | 120                     | 1658                      | 912                       | 0,75  | 25 x 25            |

| V <sub>DC</sub><br>(Surge<br>Voltage)<br>Code | Rated<br>Capa-<br>cance | Max ESR<br>20°C,<br>120Hz | Typ ESR<br>20°C,<br>120Hz | Max<br>Ripple<br>Current<br>105°C,<br>120Hz | Size<br>Ø<br>D x L |
|---|-------------------------|---------------------------|---------------------------|---|--------------------|
| (V)   | (µF)                    | (mΩ)                      | (mΩ)                      | (Arms)                                      | (mm)               |
| <b>315<br/>(365)<br/>2F</b>                   | 150                     | 1327                      | 730                       | 0,82  | 22 x 35            |
|   |                         | 1327                      | 730                       | 0,82  | 25 x 30            |
|   |                         | 1327                      | 730                       | 0,82  | 30 x 25            |
|   | 180                     | 1106                      | 608                       | 0,90  | 22 x 40            |
|   |                         | 1106                      | 608                       | 0,90  | 25 x 35            |
|   | 220                     | 905                       | 498                       | 1,00  | 22 x 45            |
|   |                         | 905                       | 498                       | 1,00  | 25 x 40            |
|   |                         | 905                       | 498                       | 1,00  | 30 x 30            |
|   | 270                     | 737                       | 406                       | 1,10  | 25 x 45            |
|   |                         | 737                       | 406                       | 1,10  | 30 x 35            |
|   |                         | 737                       | 406                       | 1,10  | 35 x 30            |
|   | 330                     | 603                       | 332                       | 1,20  | 25 x 50            |
|   |                         | 603                       | 332                       | 1,20  | 30 x 40            |
|   | 390                     | 511                       | 281                       | 1,30  | 30 x 45            |
|   |                         | 511                       | 281                       | 1,30  | 35 x 35            |
|   |                         | 424                       | 233                       | 1,40  | 30 x 50            |
|   | 470                     | 424                       | 233                       | 1,40  | 35 x 40            |
|   |                         | 356                       | 196                       | 1,50  | 35 x 45            |
| 680   | 293                     | 161                       | 1,70                      | 35 x 50                                     |                    |
| 82  | 2427                    | 1335                      | 0,64                      | 22 x 25                                     |                    |
| 100   | 1990                    | 1095                      | 0,69                      | 22 x 30                                     |                    |
|   | 1990                    | 1095                      | 0,69                      | 25 x 25                                     |                    |
| 120   | 1658                    | 912                       | 0,75                      | 22 x 35                                     |                    |
|   | 1658                    | 912                       | 0,75                      | 25 x 30                                     |                    |
| 150   | 1327                    | 730                       | 0,82                      | 22 x 40                                     |                    |
|   | 1327                    | 730                       | 0,82                      | 30 x 25                                     |                    |
|   | 1106                    | 608                       | 0,90                      | 22 x 45                                     |                    |
| 180   | 1106                    | 608                       | 0,90                      | 25 x 35                                     |                    |
|   | 1106                    | 608                       | 0,90                      | 30 x 30                                     |                    |
| 220   | 905                     | 498                       | 1,00                      | 22 x 50                                     |                    |
|   | 905                     | 498                       | 1,00                      | 25 x 40                                     |                    |
| 270   | 737                     | 406                       | 1,10                      | 25 x 50                                     |                    |
|   | 737                     | 406                       | 1,10                      | 30 x 35                                     |                    |
|   | 737                     | 406                       | 1,10                      | 35 x 30                                     |                    |
| 330   | 603                     | 332                       | 1,20                      | 30 x 45                                     |                    |
|   | 603                     | 332                       | 1,20                      | 35 x 35                                     |                    |
| 390   | 511                     | 281                       | 1,30                      | 30 x 50                                     |                    |
|   | 511                     | 281                       | 1,30                      | 35 x 40                                     |                    |
| 560   | 356                     | 196                       | 1,50                      | 35 x 50                                     |                    |
| 56  | 3553                    | 1954                      | 0,51                      | 22 x 25                                     |                    |
| 68  | 2926                    | 1610                      | 0,56                      | 22 x 30                                     |                    |
| 82  | 2926                    | 1610                      | 0,56                      | 25 x 25                                     |                    |
| 100   | 2427                    | 1335                      | 0,64                      | 22 x 35                                     |                    |
|   | 1990                    | 1095                      | 0,69                      | 25 x 30                                     |                    |
| 120   | 1658                    | 912                       | 0,75                      | 22 x 40                                     |                    |
|   | 1658                    | 912                       | 0,75                      | 25 x 35                                     |                    |
|   | 1658                    | 912                       | 0,75                      | 30 x 25                                     |                    |
| 150   | 1327                    | 730                       | 0,82                      | 22 x 50                                     |                    |
|   | 1327                    | 730                       | 0,82                      | 25 x 40                                     |                    |
|   | 1327                    | 730                       | 0,82                      | 30 x 30                                     |                    |
| 180   | 1106                    | 608                       | 0,90                      | 25 x 45                                     |                    |
|   | 1106                    | 608                       | 0,90                      | 30 x 35                                     |                    |
|   | 1106                    | 608                       | 0,90                      | 35 x 25                                     |                    |
| 220   | 905                     | 498                       | 1,00                      | 25 x 50                                     |                    |
|   | 905                     | 498                       | 1,00                      | 30 x 40                                     |                    |
|   | 905                     | 498                       | 1,00                      | 35 x 30                                     |                    |
| 270   | 737                     | 406                       | 1,10                      | 30 x 45                                     |                    |
|   | 737                     | 406                       | 1,10                      | 35 x 35                                     |                    |
|   | 737                     | 406                       | 1,10                      | 35 x 30                                     |                    |
| 330   | 603                     | 332                       | 1,20                      | 30 x 50                                     |                    |
|   | 603                     | 332                       | 1,20                      | 35 x 40                                     |                    |
| 390   | 511                     | 281                       | 1,30                      | 35 x 45                                     |                    |
| 470   | 424                     | 233                       | 1,40                      | 35 x 50                                     |                    |
| 39  | 6802                    | 3061                      | 0,37                      | 22 x 25                                     |                    |
| 47  | 5644                    | 2540                      | 0,40                      | 22 x 30                                     |                    |
| 56  | 4737                    | 2132                      | 0,47                      | 22 x 35                                     |                    |
|   | 4737                    | 2132                      | 0,47                      | 25 x 25                                     |                    |
| 68  | 3901                    | 1756                      | 0,53                      | 22 x 40                                     |                    |
|   | 3901                    | 1756                      | 0,53                      | 25 x 30                                     |                    |
| 82  | 3235                    | 1456                      | 0,56                      | 22 x 45                                     |                    |
|   | 3235                    | 1456                      | 0,56                      | 25 x 35                                     |                    |
|   | 3235                    | 1456                      | 0,56                      | 30 x 25                                     |                    |
| 100   | 2653                    | 1194                      | 0,64                      | 22 x 50                                     |                    |
|   | 2653                    | 1194                      | 0,64                      | 25 x 40                                     |                    |
|   | 2653                    | 1194                      | 0,64                      | 30 x 30                                     |                    |
| 120   | 2211                    | 995                       | 0,72                      | 25 x 45                                     |                    |
|   | 1769                    | 796                       | 0,79                      | 25 x 50                                     |                    |
| 150   | 1769                    | 796                       | 0,79                      | 30 x 40                                     |                    |
|   | 1769                    | 796                       | 0,79                      | 35 x 30                                     |                    |
|   | 1474                    | 664                       | 0,87                      | 30 x 45                                     |                    |
| 180   | 1474                    | 664                       | 0,87                      | 35 x 35                                     |                    |
|   | 1206                    | 543                       | 1,00                      | 30 x 50                                     |                    |
| 220   | 1206                    | 543                       | 1,00                      | 35 x 40                                     |                    |
|   | 983                     | 443                       | 1,19                      | 35 x 45                                     |                    |
| 330   | 804                     | 362                       | 1,38                      | 35 x 50                                     |                    |

Snap-In

Custom products are available on request.

## Order Code SMD, Radial, Snap-In

| EC                          | R                     | 1C  | PT           | 101                                  | M                     | FF  | 25                  | O611            | JE xxxxx          |
|-----------------------------|-----------------------|---|--------------|--------------------------------------|-----------------------|---|---------------------|-----------------|-------------------|
| Technology                  | Terminal Type         | Rated Voltage Code                              | Series Code  | Capacitance Code (in $\mu\text{F}$ ) | Capacitance Tolerance | Lead Form   | Terminal/Pitch Size | Dimension       | for Specials only |
| EC = Electrolytic Capacitor | SMD = V<br>Radial = R | For coding please refer to the pages of ratings | CD VS = BS   | 0,47 = R47                           | $\pm 20\%$ = M        | SMD:  |                     | 4x7 = 0407      |                   |
|                             |                       |   | CD VH = VH   | 1,0 = 010                            | $\pm 10\%$ = K        | Taped = FF  | Terminal = T2       | 5x11,5 = 0511   |                   |
| PC = Polymer Capacitor      | Snap-In = S           |   | CD VZ = VZ   | 2,2 = 2R2                            | +30 / -10% = Q        | Radial:   |                     | 6,3x11,5 = 0611 |                   |
|                             |                       |   | CD 261 = LK  | 100 = 101                            | +50 / -10% = T        | Long Lead = LL  | 2,0mm = 20          | 35x80 = 3580    |                   |
|                             |                       |   | CD 261X = QX | 1000 = 102                           |                       | Cut 5,0mm = CB  | 2,5mm = 25          | 45x100 = 45100  |                   |
|                             |                       |   | CD 262 = QM  | 10000 = 103                          |                       | Cut 4,5mm = CC  | 3,5mm = 35          |                 |                   |
|                             |                       |   | CD 263 = BK  |                                      |                       | Cut 4,0mm = CD  | 5,0mm = 50          |                 |                   |
|                             |                       |   | CD 269 = PH  |                                      |                       | Cut 3,5mm = CE  | 7,5mm = 75          |                 |                   |
|                             |                       |   | CD 281 = LL  |                                      |                       | Cut 3,0mm = CF  | 10,0mm = 10         |                 |                   |
|                             |                       |   | CD 284 = XY  |                                      |                       | on request: alternative lead forms (axial, 90° - angle, others) |                     |                 |                   |
|                             |                       |   | CD 287 = GC  |                                      |                       |   | 12,5mm = 12         |                 |                   |
|                             |                       |   | CD 28L = QL  |                                      |                       | Snap-In:  |                     |                 |                   |
|                             |                       |   | CD 293 = BZ  |                                      |                       | 4,0mm Pin Length = T4   | 2 Pin = P2          |                 |                   |
|                             |                       |   | CD 294 = BW  |                                      |                       | 6,3mm Pin Length = T6   | 3 Pin = P3          |                 |                   |
|                             |                       |   | CD 295 = BC  |                                      |                       | Soldering Pin = S4  | 4 Pin = P4          |                 |                   |
|                             |                       |   | CD 296 = KC  |                                      |                       |   | 5 Pin = P5          |                 |                   |
|                             |                       |   | CD 297 = BB  |                                      |                       | preferred   |                     |                 |                   |
|                             |                       |   | CD 299 = PG  |                                      |                       |   |                     |                 |                   |
|                             |                       |   | CD 29D = HR  |                                      |                       |   |                     |                 |                   |
|                             |                       |   | CD 29H = QH  |                                      |                       |   |                     |                 |                   |
|                             |                       |   | CD 29L = QL  |                                      |                       |   |                     |                 |                   |
|                             |                       |   | HCP = CP     |                                      |                       |   |                     |                 |                   |
|                             |                       |   | HPM = PM     |                                      |                       |   |                     |                 |                   |
|                             |                       |   | HVC = VC     |                                      |                       |   |                     |                 |                   |

## Technical Specification SMD Type

### Dimensions

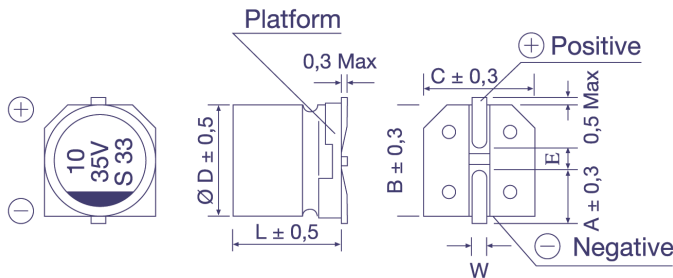

| Ø D x L | 4x5,4     | 5x5,4 | 6,3x5,4 | 6,3x7,7 | 8x10,5    | 8x11,8 | 10x10,5 | 10x12,7 |
|---------|-----------|-------|---------|---------|-----------|--------|---------|---------|
| A       | 1,8       | 2,1   | 2,4     | 2,5     | 2,9       | 2,9    | 3,2     | 3,2     |
| B       | 4,3       | 5,3   | 6,6     | 6,6     | 8,3       | 8,4    | 10,3    | 10,4    |
| C       | 4,3       | 5,3   | 6,6     | 6,6     | 8,3       | 8,4    | 10,3    | 10,4    |
| E       | 1,0       | 1,3   | 2,2     | 2,2     | 3,1       | 3,1    | 4,5     | 4,5     |
| L       | 5,4       | 5,4   | 5,4     | 7,7     | 10,5      | 11,8   | 10,5    | 12,7    |
| W       | 0,5 - 0,8 |       |         |         | 0,7 - 1,1 |        |         |         |

in mm

### Taping Dimensions

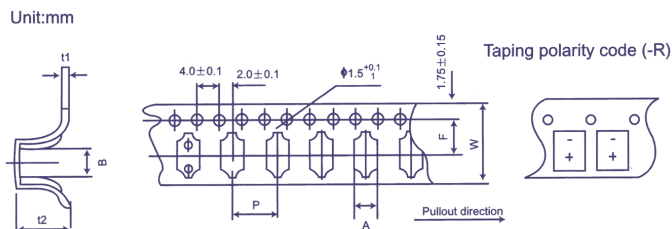

| Size (DxL) | w ± 0,3 | A ± 0,2 | B ± 0,2 | P ± 0,1 | t2 ± 0,2 | F ± 0,1 | t1 ± 0,1 |
|------------|---------|---------|---------|---------|----------|---------|----------|
| 4 x 5,4    | 12,0    | 5,0     | 5,0     | 8,0     | 5,8      | 5,5     | 0,4      |
| 5 x 5,4    | 12,0    | 6,0     | 6,0     | 12,0    | 5,8      | 5,5     | 0,4      |
| 6,3 x 5,4  | 16,0    | 7,0     | 7,0     | 12,0    | 5,8      | 7,5     | 0,4      |
| 6,3 x 7,7  | 16,0    | 7,0     | 7,0     | 12,0    | 8,4      | 7,5     | 0,4      |
| 8 x 10,5   | 24,0    | 8,7     | 8,7     | 16,0    | 11,0     | 11,5    | 0,5      |
| 8 x 11,8   | 24,0    | 8,7     | 8,7     | 16,0    | 12,3     | 11,5    | 0,5      |
| 10 x 10,5  | 24,0    | 10,7    | 10,7    | 16,0    | 11,0     | 11,5    | 0,5      |
| 10 x 12,7  | 24,0    | 10,7    | 10,7    | 16,0    | 14,0     | 11,5    | 0,5      |

in mm

### Soldering Profile (Aluminium Electrolytic Capacitors)

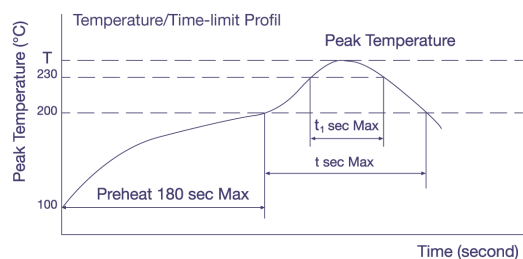

#### Allowable Range of Peak Temperature

| Size        | T (°C) | t (second) | t <sub>1</sub> (second) |
|-------------|--------|------------|-------------------------|
| Ø 4 ~ 6,3   | 250    | 90         | 40                      |
| Ø 8 x 10,5  | 240    | 90         | 30                      |
| Ø 10 x 10,5 | 235    | 60         | 30                      |

| Diameter | w      | D      |
|----------|--------|--------|
| 4; 5     | 14 ± 1 | 50 ± 1 |
| 6,3      | 18 ± 1 | 50 ± 1 |
| 8; 10    | 25 ± 1 | 50 ± 1 |
| Polymer  | 25 ± 1 | 80 ± 1 |

in mm

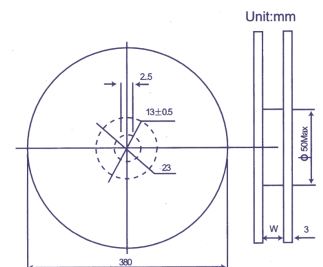

For more details or Soldering Profiles of Radials or Polymer-Capacitors please contact our local Sales Offices.

## Technical Specification Snap-In Type

**Pin Type: Snap-In**  
Order Code: T6, T4

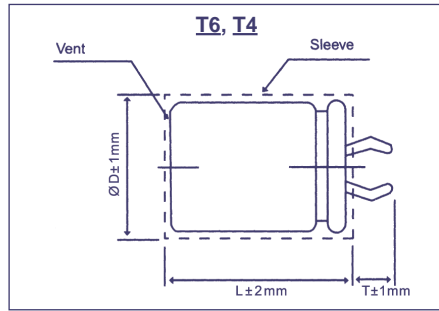

|              |     |     |
|--------------|-----|-----|
| Terminal     | T6  | T4  |
| Pin Length T | 6,3 | 4,0 |

**Pin Type: Soldering**  
Order Code: S4

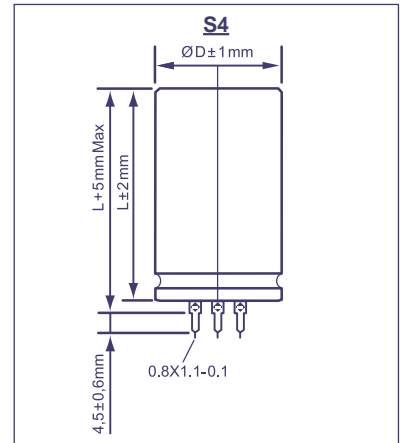

**Snap-In Terminal**  
Order Code: P2, P3, P4

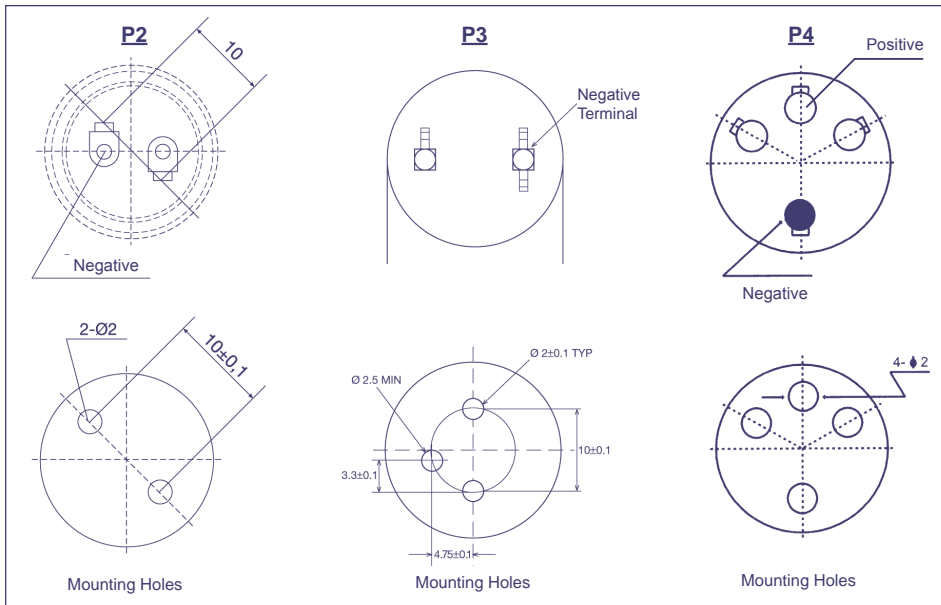

**Soldering Terminal**  
Order Code: P5

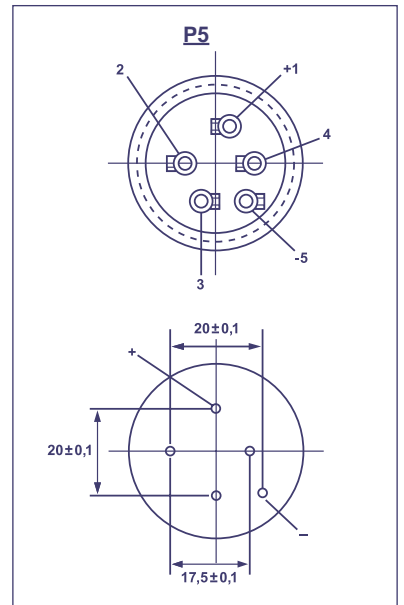

P3 only T4 Terminal

## Order Code Screw Type

| EC                          | G             | 1C  | BP          | 101              | M                                      | B                                     | E         | 160       | A361                               | JExxxxx           |
|-----------------------------|---------------|---|-------------|------------------|--|---------------------------------------|-----------|-----------|------------------------------------|-------------------|
| Technology                  | Terminal Type | Rated Voltage Code                              | Series Code | Capacitance Code | Capacitance Tolerance                  | Mounting                              | Diameter  | Length    | For Terminal Code see tables below | for Specials only |
| EC = Electrolytic Capacitor | Screw = G     | For coding please refer to the pages of ratings | CD 135 = BP | 100 = 101        | ±20% = M                               | Bolt = B                              | 36 = A    | 53 = 053  |                                    |                   |
|                             |               |   | CD 136 = PK | 1000 = 102       | ±10% = K                               | No double sleeve = N                  | 40 = B    | 65 = 065  |                                    |                   |
|                             |               |   | CD 137 = PX | 10000 = 103      | +30 / -10% = Q                         | 2 stoppers bracket+double sleeve* = I | 51 = C    | 96 = 096  |                                    |                   |
|                             |               |   | CD 138 = PC |                  | +20 / -0% = R                          | 3 stoppers bracket+double sleeve* = Y | 64 = D    | 100 = 100 |                                    |                   |
|                             |               |   | CD 139 = BL |                  | +50 / -10% = T                         | No bracket, but double sleeve* = D    | 77 = E    | 115 = 115 |                                    |                   |
|                             |               |   |             | <b>preferred</b> | * Double sleeve for diameter ≥ 51 only | 90 = F                                | 236 = 236 |           |                                    |                   |
|                             |               |   |             |                  |  | 101 = G                               |           |           |                                    |                   |

## Technical Specification Screw Type

### Dimensions

**Standard Housing**  
Order Code: I, Y, D, N

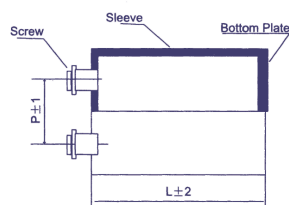
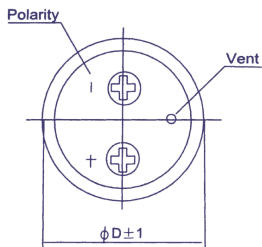

**Bolt Housing**  
Order Code: B

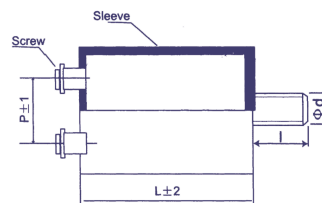

| Ø D    | Ø d | l  |
|--------|-----|----|
| Ø 36   | M8  | 12 |
| ≥ Ø 51 | M12 | 16 |

in mm