

**QUAD INTEGRATED LOW SIDE DRIVER**

**ADVANCE DATA**

- LOW ON RESISTANCE (0.25Ω EACH OUTPUT)
- VARIOUS FAULT SITUATION DETECTOR (SHORT CIRCUIT, OPEN LOAD)
- LOAD DUMP PROTECTION
- OVER-VOLTAGE PROTECTION
- INDIVIDUAL OUTPUT OVER-CURRENT PROTECTION
- CLAMPING VOLTAGE (HIGHER THAN 60V) FOR DRIVING INDUCTIVE LOAD

**DESCRIPTION**

The L9363 is a monolithic quad low side driver with DMOS outputs, designed for automotive environment especially in the injectors driving field.

Each output has a dedicated overcurrent protection and the device is overvoltage protected. The Status pin provides the microprocessor with the fault status feedback.

**BLOCK DIAGRAM**

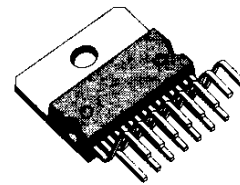
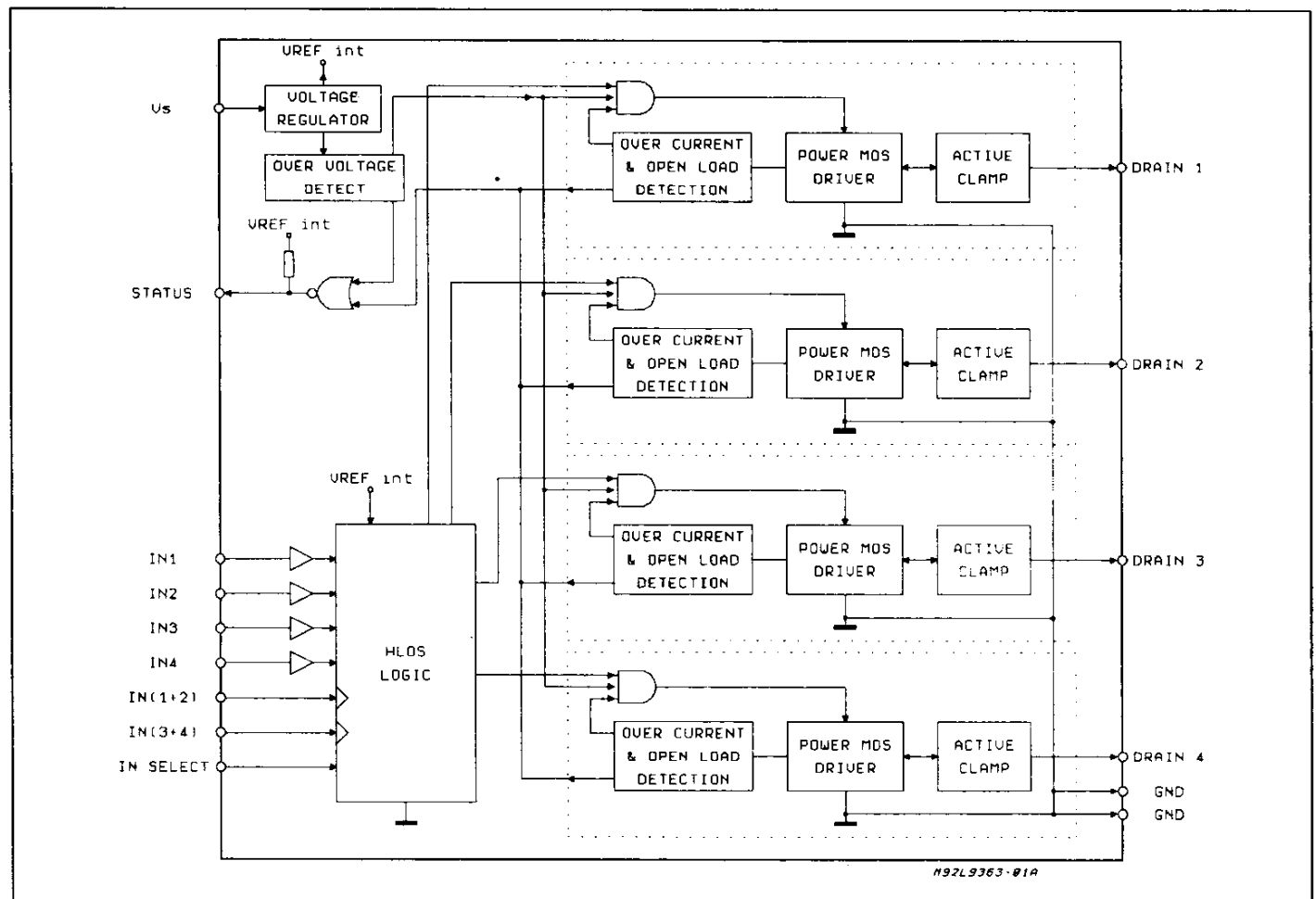

**MULTIWATT 15**

**ORDERING NUMBER: L9363**

The device is housed in a Multiwatt 15 pin package. An internal zener diode connected between the source and the drain of each power DMOS allows a fast recirculation with a clamping voltage higher than 60V.

## ABSOLUTE MAXIMUM RATINGS

Symbol	Parameter	Value	Unit
$V_S$	DC Supply Voltage	0 to 25	V
$V_{STR}$	Transient Supply Voltage	-1.5 to 60	V
$V_{Cp}$	Peak Clamping Voltage ( $I_d = 20mA$ )	60 to 80	V
$f_{max}$	Operating Frequency	400	Hz
$I_d$	Drain Current Self Limiting (min)	3	A
$V_{IN}$	Input Voltage	-0.5 to 7.5	V
$P_{tot}$	Total Power Dissipation (max 25 °C)	42	W
$T_j, T_{stg}$	Junction and Storage Temperature Range	-40 to 150	°C

## BLOCK DIAGRAM

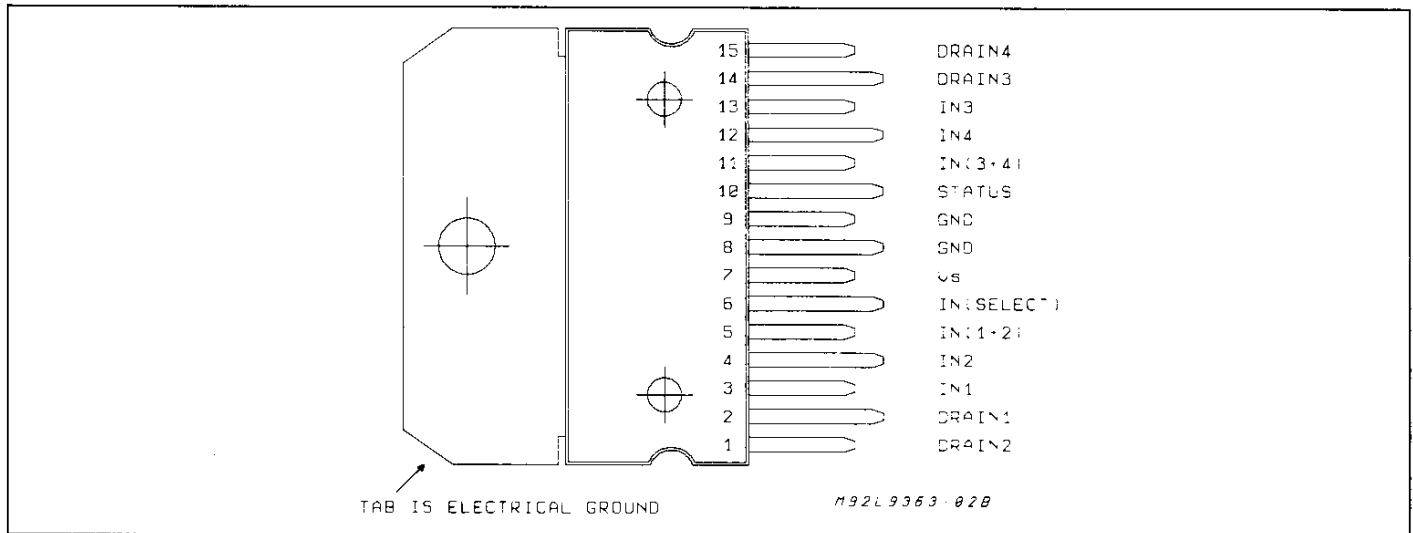

## THERMAL DATA

$R_{th\ j-amb}$	Thermal resistance junction to ambient	35	°C/W
$R_{th\ j-case}$	Thermal resistance junction to case	3	°C/W

## PIN FUNCTIONS

Pin	Symbols	Functions
1,2,14,15	DRAINS	Outputs 2, 1, 3, 4 respectively
3,4,13,12	IN	Input 1,2,3,4 respectively
5	IN (1+2)	This input pin drives output 1 and 2 in the same time when the IN select pin is "HIGH"
6	IN Select	This pin selects which input will be used to drive the outputs. When this pin is "LOW" the normal input pins drive the outputs. When it's "HIGH", the IN (x + y) (see below) drive the outputs.
7	$V_S$	This pin is connected to $V_{bat}$ .
8,9	GND	Ground
10	STATUS	This pin provides fault status information about the device. The following faults will be indicated by a low state on this pin: 1) Short to $V_{bat}$ or overcurrent condition on any output, 2) Open load condition on any output. 3) Over-voltage shutdown mode.
11	IN (3+4)	This input pin drives output 3 and 4 in the same time when the IN select pin is "HIGH"

**ELECTRICAL CHARACTERISTICS** ( $V_S = 5.5$  to  $14.5V$ ,  $T_j = -40$  to  $125^\circ C$  unless otherwise specified;

Symbol	Parameter	Test Condition	Min.	Typ.	Max.	Unit
$V_S$ & DRAIN	Operating Supply Voltage and Outputs		5.5		25	V
$V_{IH}$	Input High Voltage	$I_D = 1A$	3.0			V
$V_{Ihyst}$	Input High Voltage Hysteresis	$I_D = 1A$	0.4			V
$V_{IL}$	Input Low Voltage	$I_D = 80\mu A$			0.8	V
$I_{IH}$	Input High Current	$V_I = 3V$			50	$\mu A$
$I_{IL}$	Input Low Current	$V_I = 0.8V$			50	$\mu A$
$I_{DSS}$	Zero Input Voltage Drain Current	$V_S = 14.5V$ ; $V_{LD} = 25V$ $V_{LD} = 58V$			500 2	$\mu A$ mA
$I_S$	Logic Supply Current	$V_S = 13V$ ; $V_I = 0.4V$			7	mA
$I_{D(lim)}$	On State Limiting Current	$V_S = 13V$ ; $V_I = 5V$	3.0			A
$R_{dson}$	Drain Source On Resistance	$V_S = 13V$ ; $I_D = 1A$ ; $T_j = 25^\circ C$ $V_S = 8V$ ; $I_D = 0.7A$ ; $T_j = 25^\circ C$ $V_S = 5.5V$ ; $I_D = 0.4A$ ; $T_j = 25^\circ C$ $V_S = 13V$ ; $I_D = 1A$ ; $T_j = 125^\circ C$ $V_S = 13V$ ; $I_D = 1A$ ; $T_j = -40^\circ C$			0.25 0.4 0.5 0.5 0.25	$\Omega$ $\Omega$ $\Omega$ $\Omega$ $\Omega$
$t_{SS}$	Short Circuit Sense Time (fig 2 and 3)	$V_I = 5V$ ; $R_L = 0.05\Omega$ ; $V_S \geq 9V$ $t_{SSAND}$ , $t_{ref}$ must be set such that the short circuit duty cycle $t_{SS}/(t_{SS} + t_{ref})$ is less than 10%	10		250	$\mu s$
$t_{ref}$	Short Circuit Refresh Time (fig 2 and 3)	$V_I = 5V$ ; $R_L = 0.05\Omega$ ; $V_S \geq 9V$	1.5		7	ms
$t_{SOFF}$	Open Load Off Sense time (fig. 4)	$V_S = 13V$ ; $V_I = 5V$ ; Open Load	1.0	20	40	$\mu s$
$t_{SON}$	Open Load On Sense time (fig. 5)	$V_S = 13V$ ; $V_I = 5V$ ; Open Load	1.0	2	4.0	ms
$t_{STO}$	Fault Status Off Time (fig.2 and 3)	$V_S = 13V$ ; $V_I = 5V$ ; $R_L = 0.05\Omega$ ; or Open Load		3	10	$\mu s$
$t_{PHL}$	Turn on Delay Time (fig.1)	$V_S = 13V$ ; $R_L = 30\Omega$ ;		2	10	$\mu s$
$t_{PLH}$	Turn off Delay Time (fig.1)	$V_S = 13V$ ; $R_L = 30\Omega$ ;		7.5	15	$\mu s$
$t_r$	Rise Time (fig.1)	$V_S = 13V$ ; $R_L = 30\Omega$ ;		5.0	10	$\mu s$
$t_f$	Fall Time (fig.1)	$V_S = 13V$ ; $R_L = 30\Omega$ ;		5.0	10	$\mu s$
	Device Turn On Threshold			5		V
	Over Voltage Shutdown Threshold		30		38	V
	Over Voltage Reset Hysteresis			5	7	V
	Status Low Voltage	$I_{stl} = 10mA$ Open Load			0.4	V
	Status High Voltage	$I_{sth} = 30\mu A$ Open Load	3.0		5.5	V
$V_{off}$	Open Load "OFF" Detection Voltage	$V_S = 13V$ ; $V_I = 0V$ Open Load (fig. 4)	2.4		5	V
	Open Load Detection Current	$V_S = 13V$ ; $V_I = 5V$ Open Load (fig. 5) $T_j = 125^\circ C$ $T_j = 25^\circ C$ $T_j = 40^\circ C$		80 110 150	100 130 190	mA mA mA

**FAULT LOGIC OPERATION**

Faults conditions include fully shorted or partially shorted loads, open loads and overvoltage at  $V_S$ . An overvoltage condition will shutdown all the outputs while a shorted load will only shutdown the affected output. In either case the device shall resume normal operation when the fault situation no longer exists. The STATUS pin shall indicate a fault for any of the fault conditions described above. The fault status for overcurrent and open

load conditions acts individually for each output, while overvoltage shutdown acts independently from the input. The output and STATUS line operation for each type of fault is described in more detail below.

**SHORT TO  $V_S$  / OVER CURRENT FAULT**

The status line will switch to a low level as long as the input is high, if the output current corresponding to that input reaches the Current Limit,  $I_{D(lim)}$ ,

specified in the electrical specification for a period of time in excess of  $t_{ss}$ .

This condition indicates an over current fault and will cause that output to shutdown regardless of its input value, while other outputs will continue normal operation. As long as the input remains high, the device will continually retry energizing the load at a frequency defined by the Refresh Time,  $T_{ref}$ . The sense time and refresh time will determine the duty cycle at which a shorted load will be driven. This duty cycle must not cause the driver to exceed its thermal capabilities. During the overcurrent sense time the status  $C_{pin}$  will be at a high level and current limiting will take effect during the over current sense time. After the over current condition is removed, the output driver will operate normally and the Status line will remain high when that output is energized. Refer to Figure 2 & 3 for the over current condition waveforms.

#### OPEN LOAD FAULT

The status line will switch to a low level, if:

- 1) while all outputs are off, a drain voltage falls below the Open Load "OFF" Detection Voltage,  $V_{Ooff}$ , for a time exceeding the Open Load "OFF" Sense Time,  $t_{soff}$ , or

- 2) when an output is energized, that drain current fails to exceed the Open Load Detection Current,  $I_{oson}$ , after the Open Load On Sense Time,  $t_{oson}$ .

In case 1 the status line will remain low until the voltage level at that drain exceeds  $V_{Ooff}$  or until a non-faulted output is energized. In case 2 the Status line will remain low until the current is greater than  $I_{oson}$  or until that output is turned off. After the open condition is removed, the output will operate normally and the Status line will no longer indicate a fault.

Refer to Figure 4 & 5 for the open load condition waveforms.

#### OVER VOLTAGE SHUTDOWN

All outputs are disabled when  $V_s$  level exceeds the Overvoltage Shutdown threshold. In addition if any outputs are on when this condition occurs, it will shutdown and STATUS pin will switch to a low level.

When  $V_s$  has dropped the Over Voltage Hysteresis,  $V_{ovhyst}$ , it has returned to a normal operating voltage, the Status line will switch high, and the device will resume normal operation.

#### INTEGRATED DRIVER FUNCTION TABLE

MODE OF OPERATION	STATUS	IN SELECT	IN (1+2)	IN (3+4)	IN1 & IN2 (note 1)	OUT 1 & OUT 2 (note 1)	IN 3 & IN 4 (note 1)	OUT 3 & OUT 4 (note 1)
NORMAL OPERATION	H	L	X	X	L	H	L	H
	H	L	X	X	H	L	H	L
IN-SELECT MODE	H (note 2)	H	H	H	X	L	X	L
	H (note 2)	H	H	L	X	L	X	H
	H (note 2)	H	L	H	X	H	X	L
	H (note 2)	H	L	L	X	H	X	H
OVER VOLTAGE SHUTDOWN (note 3)	L	X	X	X	X	H (note 3)	X	H (note 3)
OPEN LOAD FAULT "ON" (OFF") (note 4)	H(L) (note 4)	X	X	X	L	?	L	?
	L	X	X	X	H	L	H	L
SHORT TO $V_{bat}$ OVER CURRENT (note 5)	H	X	X	X	L	H	L	H
	L	X	X	X	H	H	H	H

H = HIGH LEVEL    L = LOW LEVEL    X = IRRELEVANT    ? = UNKNOWN

#### NOTES;

1. Inputs and outputs 1-4 are independent in normal operation. when one output is faulted the other three outputs will operate normally.
2. IN Select Mode outputs 1 & 2 are driven by IN (1+2) and outputs 3 & 4 are driven by IN (3+4). Depending on the load type and its mode of operation, the IN (x+y) inputs can be high, low, or pulse width modulated. Status is high except under a fault condition.
3. Over-voltage shutdown occurs when  $V_s$  exceeds the normal operating range. This condition disables ALL outputs regardless of the input values and causes the Status to go low.
4. The Status pin reveals the Open Load fault when the drain current fails to exceed a minimum level when an output is on; or when all outputs are off and a drain voltage falls below the minimum level expected when the output is off. See figures 4 and 5.
5. Short to  $V_{bat}$ /Over Current Shutdown occurs when the energized output's drain current reaches the current limit and the Over Current Sense time has elapsed. The Status pin indicates this fault only when the faulted driver is energized.

**VOLTAGE CLAMP**

Each output of each device provides active clamping of positive voltage transients due to the specified inductive loads.

**IN SELECT OPERATION**

In Select mode the IN-Select pin will be pulled to a high level. The device will then disable the normal inputs and enable the IN (x+y) Inputs. IN (1+2) will control outputs 1 and 2, while IN (3+4) will control outputs 3 and 4.

**CURRENT LIMITING**

Current limiting protection is provided individually to each output. If a load becomes shorted causing full battery voltage to be applied to the drain or any over current condition, the maximum drain current will be limited as specified in the electrical specifications. Normal device functioning with no degradation will resume upon removal of the over current condition. This current limiting for the time period needed for a shorted load to be sensed,

t<sub>ss</sub>, shall provide additional protection to the output until the current shutdown can take effect.

**SYSTEM ACTUATOR**

The system actuators are typically  $13.8 \pm 0.5\Omega$  and  $6.8 \pm 0.7\text{mH}$  or  $14.5 \pm 0.72\Omega$  and  $7.2 \pm 0.7\text{mH}$  ( for fuel injectors and cold start injector). Other system actuators to be driven are variable cam timing solenoids which are  $14.5 \pm 0.72\Omega$  and  $20 \pm 1 \text{ mH}$ , shift solenoids which range from  $15.7 \pm 0.5\Omega$  to  $28 \pm 2\Omega$  and  $24 \pm 2 \text{ mH}$  to  $70 \pm 35\text{mH}$ , fuel pump relay of  $90 \pm 10\Omega$  and  $130 \pm 10\text{mH}$  and a GE194 incandescent light bulb ( $0.27\text{A}$  typ  $2.7\text{A}$  cold inrush).

All drain (outputs) have a  $0.001\mu\text{F}$  filter capacitor connected to case ground. The drains may also have an external high resistance (approximately  $200\text{K}\Omega$ ) to ground for more accurate open load detection. Unused drain pins require  $20\text{K}\Omega$  tied to  $V_s$  to prevent false "off state" open load detecting and reporting.

All loads must be powered by module  $V_s$  to protect the device from full transient on  $V_s$ .

**Figure 1: Response Times.**

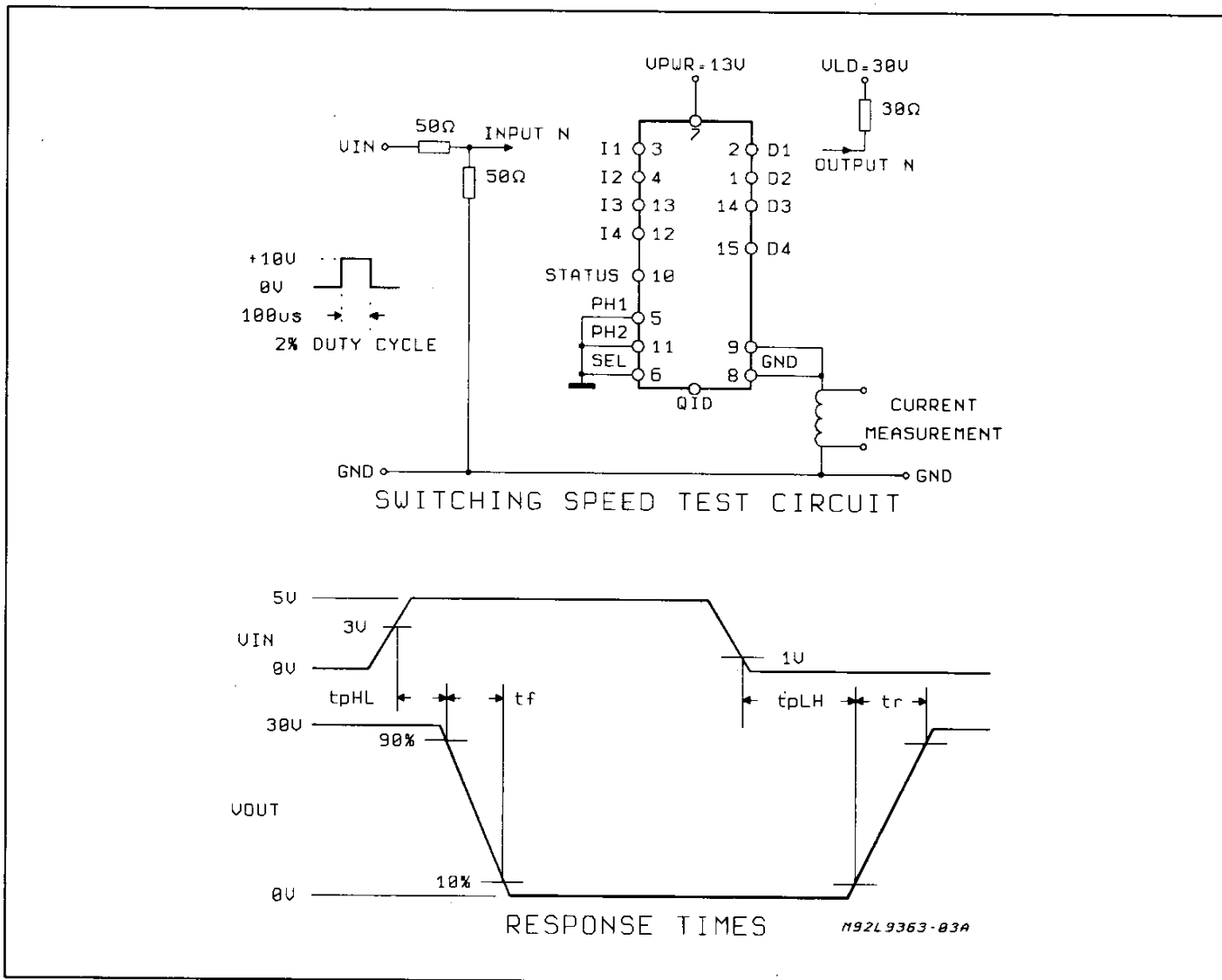

Figure 2: Over Current Status Operation

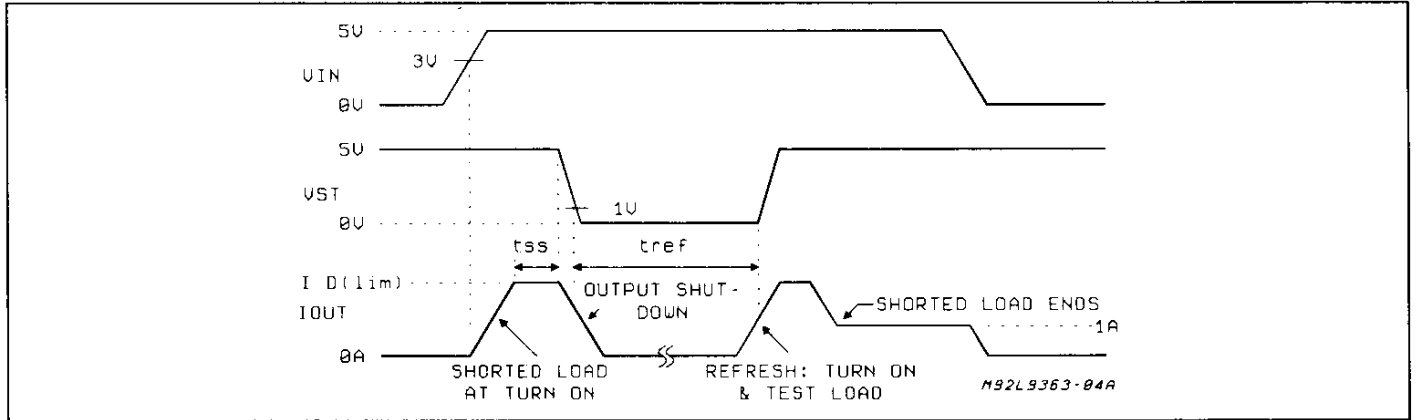

Figure 3: Over Current Status Operation

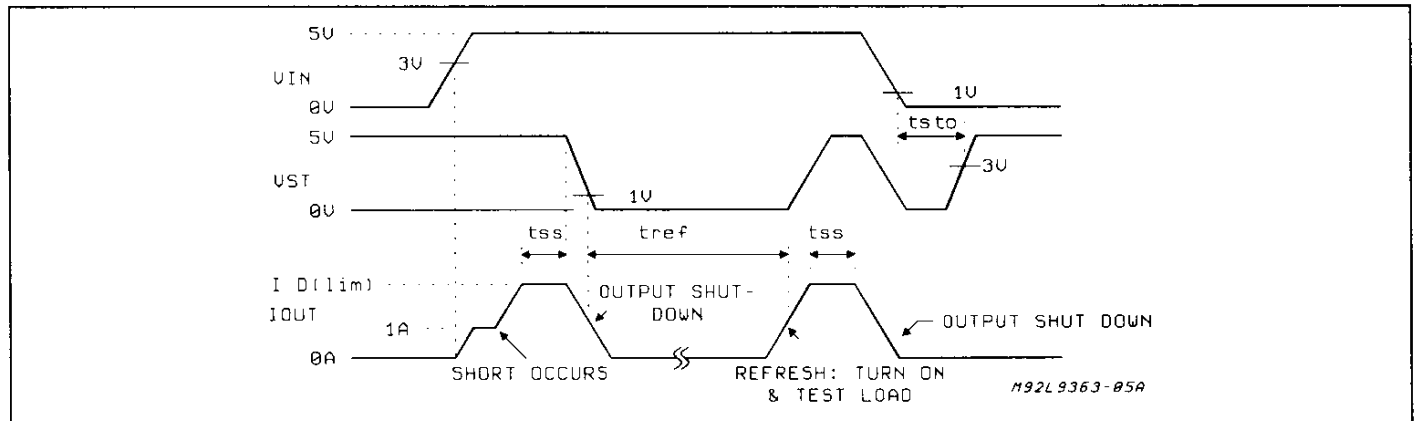

Figure 4: Off State Open Load Status Operation

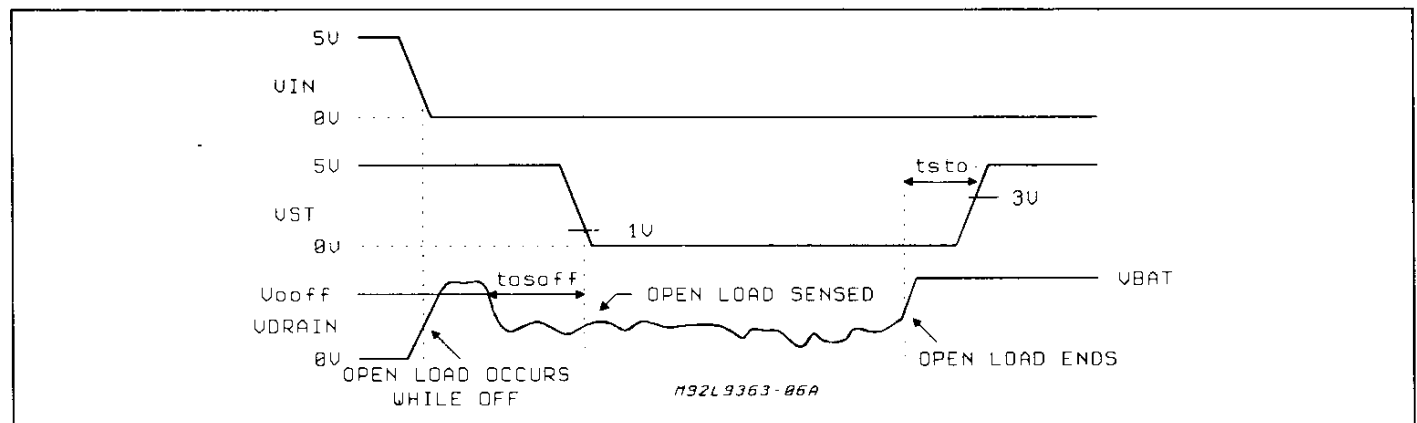

Figure 5: On State Open Load Status Operation

