



website:<http://biz.LGservice.com>
e-mail:<http://www.LGService.com/techsup.html>

LCD TV

SERVICE MANUAL

CHASSIS : LP61C

FACTORY MODEL : 26LC2R-TJ / 32LC2R-TJ

MODEL : 26LC2R / 32LC2R

CAUTION

BEFORE SERVICING THE CHASSIS,
READ THE SAFETY PRECAUTIONS IN THIS MANUAL.



CONTENTS

CONTENTS	2
SAFETY PRECAUTIONS	3
SPECIFICATION	6
ADJUSTMENT INSTRUCTION	12
TROUBLE SHOOTING	21
BLOCK DIAGRAM.....	28
WIRING	30
EXPLODED VIEW	31
REPLACEMENT PARTS LIST	35
SVC. SHEET	

SAFETY PRECAUTIONS

IMPORTANT SAFETY NOTICE

Many electrical and mechanical parts in this chassis have special safety-related characteristics. These parts are identified by \triangle in the Schematic Diagram and Replacement Parts List.

It is essential that these special safety parts should be replaced with the same components as recommended in this manual to prevent X-RADIATION, Shock, Fire, or other Hazards.

Do not modify the original design without permission of manufacturer.

General Guidance

An **isolation Transformer should always be used** during the servicing of a receiver whose chassis is not isolated from the AC power line. Use a transformer of adequate power rating as this protects the technician from accidents resulting in personal injury from electrical shocks.

It will also protect the receiver and its components from being damaged by accidental shorts of the circuitry that may be inadvertently introduced during the service operation.

If any fuse (or Fusible Resistor) in this TV receiver is blown, replace it with the specified.

When replacing a high wattage resistor (Oxide Metal Film Resistor, over 1W), keep the resistor 10mm away from PCB.

Keep wires away from high voltage or high temperature parts.

X-RAY Radiation

Warning:

The source of X-RAY RADIATION in this TV receiver is the High Voltage Section and the LCD PANEL.

For continued X-RAY RADIATION protection, the replacement panel must be the same type panel as specified in the Replacement Parts List.

To determine the presence of high voltage, use an accurate high impedance HV meter.

Adjust brightness, color, contrast controls to minimum.

Measure the high voltage.

The meter reading should indicate

23.5 \pm 1.5KV: 14-19 inch, 26 \pm 1.5KV: 19-21 inch,

29.0 \pm 1.5KV: 25-29 inch, 30.0 \pm 1.5KV: 32 inch

If the meter indication is out of tolerance, immediate service and correction is required to prevent the possibility of premature component failure.

Before returning the receiver to the customer,

always perform an **AC leakage current check** on the exposed metallic parts of the cabinet, such as antennas, terminals, etc., to be sure the set is safe to operate without damage of electrical shock.

Leakage Current Cold Check(Antenna Cold Check)

With the instrument AC plug removed from AC source, connect an electrical jumper across the two AC plug prongs. Place the AC switch in the on position, connect one lead of ohm-meter to the AC plug prongs tied together and touch other ohm-meter lead in turn to each exposed metallic parts such as antenna terminals, phone jacks, etc.

If the exposed metallic part has a return path to the chassis, the measured resistance should be between 1M Ω and 5.2M Ω .

When the exposed metal has no return path to the chassis the reading must be infinite.

An other abnormality exists that must be corrected before the receiver is returned to the customer.

Leakage Current Hot Check (See below Figure)

Plug the AC cord directly into the AC outlet.

Do not use a line Isolation Transformer during this check.

Connect 1.5K/10watt resistor in parallel with a 0.15uF capacitor between a known good earth ground (Water Pipe, Conduit, etc.) and the exposed metallic parts.

Measure the AC voltage across the resistor using AC voltmeter with 1000 ohms/volt or more sensitivity.

Reverse plug the AC cord into the AC outlet and repeat AC voltage measurements for each exposed metallic part. Any voltage measured must not exceed 0.75 volt RMS which corresponds to 0.5mA.

In case any measurement is out of the limits specified, there is possibility of shock hazard and the set must be checked and repaired before it is returned to the customer.

Leakage Current Hot Check circuit

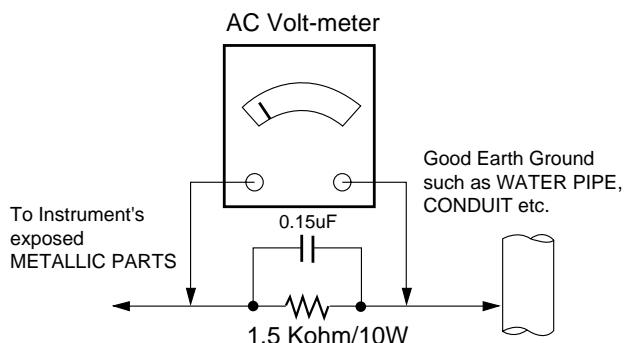

SERVICING PRECAUTIONS

CAUTION: Before servicing receivers covered by this service manual and its supplements and addenda, read and follow the *SAFETY PRECAUTIONS* on page 3 of this publication.

NOTE: If unforeseen circumstances create conflict between the following servicing precautions and any of the safety precautions on page 3 of this publication, always follow the safety precautions. Remember: Safety First.

General Servicing Precautions

1. Always unplug the receiver AC power cord from the AC power source before;
 - a. Removing or reinstalling any component, circuit board module or any other receiver assembly.
 - b. Disconnecting or reconnecting any receiver electrical plug or other electrical connection.
 - c. Connecting a test substitute in parallel with an electrolytic capacitor in the receiver.
CAUTION: A wrong part substitution or incorrect polarity installation of electrolytic capacitors may result in an explosion hazard.

2. Test high voltage only by measuring it with an appropriate high voltage meter or other voltage measuring device (DVM, FETVOM, etc) equipped with a suitable high voltage probe. Do not test high voltage by "drawing an arc".

3. Do not spray chemicals on or near this receiver or any of its assemblies.

4. Unless specified otherwise in this service manual, clean electrical contacts only by applying the following mixture to the contacts with a pipe cleaner, cotton-tipped stick or comparable non-abrasive applicator; 10% (by volume) Acetone and 90% (by volume) isopropyl alcohol (90%-99% strength)

CAUTION: This is a flammable mixture.

Unless specified otherwise in this service manual, lubrication of contacts is not required.

5. Do not defeat any plug/socket B+ voltage interlocks with which receivers covered by this service manual might be equipped.
6. Do not apply AC power to this instrument and/or any of its electrical assemblies unless all solid-state device heat sinks are correctly installed.
7. Always connect the test receiver ground lead to the receiver chassis ground before connecting the test receiver positive lead.
Always remove the test receiver ground lead last.

8. Use with this receiver only the test fixtures specified in this service manual.

CAUTION: Do not connect the test fixture ground strap to any heat sink in this receiver.

Electrostatically Sensitive (ES) Devices

Some semiconductor (solid-state) devices can be damaged easily by static electricity. Such components commonly are called *Electrostatically Sensitive (ES) Devices*. Examples of typical ES devices are integrated circuits and some field-effect transistors and semiconductor "chip" components. The following techniques should be used to help reduce the incidence of component damage caused by static by static electricity.

1. Immediately before handling any semiconductor component or semiconductor-equipped assembly, drain off any electrostatic charge on your body by touching a known earth ground. Alternatively, obtain and wear a commercially available discharging wrist strap device, which should be removed to prevent potential shock reasons prior to applying power to the

unit under test.

2. After removing an electrical assembly equipped with ES devices, place the assembly on a conductive surface such as aluminum foil, to prevent electrostatic charge buildup or exposure of the assembly.
3. Use only a grounded-tip soldering iron to solder or unsolder ES devices.
4. Use only an anti-static type solder removal device. Some solder removal devices not classified as "anti-static" can generate electrical charges sufficient to damage ES devices.
5. Do not use freon-propelled chemicals. These can generate electrical charges sufficient to damage ES devices.
6. Do not remove a replacement ES device from its protective package until immediately before you are ready to install it. (Most replacement ES devices are packaged with leads electrically shorted together by conductive foam, aluminum foil or comparable conductive material).
7. Immediately before removing the protective material from the leads of a replacement ES device, touch the protective material to the chassis or circuit assembly into which the device will be installed.
CAUTION: Be sure no power is applied to the chassis or circuit, and observe all other safety precautions.
8. Minimize bodily motions when handling unpackaged replacement ES devices. (Otherwise harmless motion such as the brushing together of your clothes fabric or the lifting of your foot from a carpeted floor can generate static electricity sufficient to damage an ES device.)

General Soldering Guidelines

1. Use a grounded-tip, low-wattage soldering iron and appropriate tip size and shape that will maintain tip temperature within the range or 500 °F to 600 °F.
2. Use an appropriate gauge of RMA resin-core solder composed of 60 parts tin/40 parts lead.
3. Keep the soldering iron tip clean and well tinned.
4. Thoroughly clean the surfaces to be soldered. Use a mall wire-bristle (0.5 inch, or 1.25cm) brush with a metal handle. Do not use freon-propelled spray-on cleaners.
5. Use the following unsoldering technique
 - a. Allow the soldering iron tip to reach normal temperature. (500 °F to 600 °F)
 - b. Heat the component lead until the solder melts.
 - c. Quickly draw the melted solder with an anti-static, suction-type solder removal device or with solder braid.
CAUTION: Work quickly to avoid overheating the circuitboard printed foil.
6. Use the following soldering technique.
 - a. Allow the soldering iron tip to reach a normal temperature (500 °F to 600 °F)
 - b. First, hold the soldering iron tip and solder the strand against the component lead until the solder melts.
 - c. Quickly move the soldering iron tip to the junction of the component lead and the printed circuit foil, and hold it there only until the solder flows onto and around both the component lead and the foil.
CAUTION: Work quickly to avoid overheating the circuit board printed foil.
 - d. Closely inspect the solder area and remove any excess or splashed solder with a small wire-bristle brush.

IC Remove/Replacement

Some chassis circuit boards have slotted holes (oblong) through which the IC leads are inserted and then bent flat against the circuit foil. When holes are the slotted type, the following technique should be used to remove and replace the IC. When working with boards using the familiar round hole, use the standard technique as outlined in paragraphs 5 and 6 above.

Removal

1. Desolder and straighten each IC lead in one operation by gently prying up on the lead with the soldering iron tip as the solder melts.
2. Draw away the melted solder with an anti-static suction-type solder removal device (or with solder braid) before removing the IC.

Replacement

1. Carefully insert the replacement IC in the circuit board.
2. Carefully bend each IC lead against the circuit foil pad and solder it.
3. Clean the soldered areas with a small wire-bristle brush.
(It is not necessary to reapply acrylic coating to the areas).

"Small-Signal" Discrete Transistor

Removal/Replacement

1. Remove the defective transistor by clipping its leads as close as possible to the component body.
2. Bend into a "U" shape the end of each of three leads remaining on the circuit board.
3. Bend into a "U" shape the replacement transistor leads.
4. Connect the replacement transistor leads to the corresponding leads extending from the circuit board and crimp the "U" with long nose pliers to insure metal to metal contact then solder each connection.

Power Output, Transistor Device

Removal/Replacement

1. Heat and remove all solder from around the transistor leads.
2. Remove the heat sink mounting screw (if so equipped).
3. Carefully remove the transistor from the heat sink of the circuit board.
4. Insert new transistor in the circuit board.
5. Solder each transistor lead, and clip off excess lead.
6. Replace heat sink.

Diode Removal/Replacement

1. Remove defective diode by clipping its leads as close as possible to diode body.
2. Bend the two remaining leads perpendicular y to the circuit board.
3. Observing diode polarity, wrap each lead of the new diode around the corresponding lead on the circuit board.
4. Securely crimp each connection and solder it.
5. Inspect (on the circuit board copper side) the solder joints of the two "original" leads. If they are not shiny, reheat them and if necessary, apply additional solder.

Fuse and Conventional Resistor

Removal/Replacement

1. Clip each fuse or resistor lead at top of the circuit board hollow stake.
2. Securely crimp the leads of replacement component around notch at stake top.
3. Solder the connections.

CAUTION: Maintain original spacing between the replaced component and adjacent components and the circuit board to prevent excessive component temperatures.

Circuit Board Foil Repair

Excessive heat applied to the copper foil of any printed circuit board will weaken the adhesive that bonds the foil to the circuit board causing the foil to separate from or "lift-off" the board. The following guidelines and procedures should be followed whenever this condition is encountered.

At IC Connections

To repair a defective copper pattern at IC connections use the following procedure to install a jumper wire on the copper pattern side of the circuit board. (Use this technique only on IC connections).

1. Carefully remove the damaged copper pattern with a sharp knife. (Remove only as much copper as absolutely necessary).
2. Carefully scratch away the solder resist and acrylic coating (if used) from the end of the remaining copper pattern.
3. Bend a small "U" in one end of a small gauge jumper wire and carefully crimp it around the IC pin. Solder the IC connection.
4. Route the jumper wire along the path of the out-away copper pattern and let it overlap the previously scraped end of the good copper pattern. Solder the overlapped area and clip off any excess jumper wire.

At Other Connections

Use the following technique to repair the defective copper pattern at connections other than IC Pins. This technique involves the installation of a jumper wire on the component side of the circuit board.

1. Remove the defective copper pattern with a sharp knife. Remove at least 1/4 inch of copper, to ensure that a hazardous condition will not exist if the jumper wire opens.
2. Trace along the copper pattern from both sides of the pattern break and locate the nearest component that is directly connected to the affected copper pattern.
3. Connect insulated 20-gauge jumper wire from the lead of the nearest component on one side of the pattern break to the lead of the nearest component on the other side. Carefully crimp and solder the connections.
CAUTION: Be sure the insulated jumper wire is dressed so the it does not touch components or sharp edges.

SPECIFICATION

NOTE : Specifications and others are subject to change without notice for improvement.

1. Application range

This specification is applied to LP61C chassis.

2. Requirement for Test

Testing for standard of each part must be followed in below condition.

- (1) Temperature : 25°C±5°C(77±9°F), CST : 40±5
- (2) Humidity : 65%±10%
- (3) Power : Standard input voltage (AC 100-240V, 50/60Hz)
*Standard Voltage of each products is marked by models
- (4) Specification and performance of each parts are followed each drawing and specification by part number in accordance with BOM.
- (5) The receiver must be operated for about 20 minutes prior to the adjustment.

3. Test method

- 3.1 Performance : LGE TV test method followed
- 3.2 Demanded other specification
Safety : CE, IEC Specification
EMC : CE, IEC

4. Electrical Specification

4.1 Module Specification

4.1.1 General Specification(26/32/37" LCD MODULE)

No	Item	Specification	Remark
1.	Display Screen Device	26/32inch wide Color Display Module	LCD
2.	Aspect Ratio	16:9	
3.	LCD Module	26/32 TFT WXGA LCD	MAKER : AUO/CMO/LPL
4.	Operating Environment	1) Temp. : 0 ~ 40 deg 2) Humidity : 0 ~ 85%	LGE SPEC
5.	Storage Environment	3) Temp. : -20 ~ 60 deg 4) Humidity : 0 ~ 85 %	
6.	Input Voltage	AC100 ~ 240V, 50/60Hz	
7.	Power Consumption	Power on (White) ≤ max 160W (32") ≤ max 130W (26") St-By (Red) : 1.0 W	Volume: 1/8 volume of sound distortion point

4.2 Model Specification
4.2.1 NON-EU / CHINA (TJ/CJ)

No	Item	Specification	Remark	
1.	Market	NON EU / CHINA	26/32LC2R-TJ 26/32/37LC2R-CJ	
2.	Broadcasting system	PAL BG/DK, PAL I/II, NTSC-M		
3.	Available Channel	BAND	PAL	NTSC
		VHF/UHF CATV	C1~C69 S1~S47	2~83 1~71
4.	Receiving system	Upper Heterodyne		
5.	Video Input (2EA)	PAL, SECAM, NTSC	4 System : PAL, SECAM, NTSC, PAL60	
6.	Monitor Output (1EA)	PAL, SECAM, NTSC	4 System : PAL, SECAM, NTSC, PAL60	
7.	S-Video Input (1EA)	PAL, SECAM, NTSC	4 System : PAL, SECAM, NTSC, PAL60	S-video Priority
8.	Component Input (2EA)	Y/Cb/Cr, Y/ Pb/Pr		
9.	RGB Input (1EA)	RGB-PC, RGB-DTV		
10.	HDMI Input (1EA)	HDMI-DTV	EXCEPT 26/32/37LC2R - CJ (CJ : NO HDMI - Spec. Out)	
11.	Audio Input (5 EA)	PC Audio, Component (2EA), AV (2EA)	L/R Input	
12.	Wired Control (1EA)			
13.	Variable Audio out(1EA)			

5. Chroma & Brightness (Optical)

5.1 LCD Module

No	Item	Min	Typ	Max	Unit	Maker	Remark
1	Luminance	350	500		cd/m ²	AUO 26", 32", 37"	-50cm from the surface - Full White Pattern
			550			LPL 26", 32"	
						CMO 27", 32"	
2	View angle (R/L, U/D)		176/176		degree	AUO 26"	- CR >10
			170/170			AUO 32"	
			176/176			AUO 37"	
			170/170			CMO 27"	- CR > 20
			176/176			CMO 32"	
			178/178			LPL 26", 32"	
3	Color Coordinate	Typ. -0.03	0.280	Typ. +0.03			- CIE 1393 AUO 26, 37" (32")
			0.290				
			0.640				
			0.330				
			0.290 (0.270)				
			0.600				
			0.150				
			0.060				

No	Item		Min	Typ	Max	Unit	Maker	Remark				
	White	X	Typ. -0.03	0.285	Typ. +0.03			CMO 27" (32")				
		Y		0.293								
	Red	X		0.646 (0.652)								
		Y		0.332								
	Green	X		0.269 (0.270)								
		Y		0.600 (0.589)								
	Blue	X		0.142 (0.141)								
		Y		0.072 (0.068)								
	White	X		Typ. -0.03				0.275 (0.285)	Typ. +0.03			LPL 26" (32")
		Y						0.279 (0.293)				
	Red	X						0.630 (0.640)				
		Y						0.338 (0.343)				
	Green	X						0.283 (0.280)				
		Y						0.607 (0.605)				
Blue	X	0.147 (0.145)										
	Y	0.064 (0.065)										
4	Contrast ratio				800 / 1200 / 1000							AUO 26" / 32" / 37"
					600 / 1000							CMO 27" / 32"
					800 (1600)							LPL 26, 32" (with AI)
5	Color Temperature	Normal	8300		9300	10300						- 85IRE Full White Pattern
		Warm	6200		7200	8200						
		Cool	10000		11000	12000						

6. Component Video Input (Y, PB, PR)

No	Resolution	H-freq(kHz)	V-freq.(kHz)	Pixel clock(MHz)	Proposed	Remarks
1.	720x480	15.73	59.94	13.500	SDTV, DVD 480I(525I)	
2.	720x480	15.75	60.00	13.514	SDTV, DVD 480I(525I)	
3.	720x576	15.625	50.00	13.500	SDTV, DVD 576I(625I), 50Hz	
4.	720x480	31.47	59.94	27.000	SDTV 480P	
5.	720x480	31.50	60.00	27.027	SDTV 480P	
6.	720x576	31.25	50.00	27.000	SDTV 576P 50Hz	
7.	1280x720	44.96	59.94	74.176	HDTV 720P	
8.	1280x720	45.00	60.00	74.250	HDTV 720P	
9.	1280x720	37.50	50.00	74.25	HDTV 720P 50Hz	
10.	1920x1080	33.72	59.94	74.176	HDTV 1080I	
11.	1920x1080	33.75	60.00	74.250	HDTV 1080I	
12.	1920x1080	28.125	50.00	74.250	HDTV 1080I 50Hz,	

7. RGB Input (Analog PC)

No	Resolution	H-freq(kHz)	V-freq.(kHz)	Pixel clock(MHz)	Proposed	Remarks
1.	640x350	31.468	70.80	25.17	EGA	
2.	720x400	31.469	70.80	28.321	DOS	
3.	640x480	31.469	59.94	25.17	VESA(VGA)	
4.	800x600	37.879	60.31	40.00	VESA(SVGA)	
5.	1024x768	48.363	60.00	65.00	VESA(XGA)	
6.	1280x768	47.776	59.87	79.50	WXGA	XGA only
7.	1360x768	47.720	59.799	84.75	WXGA	XGA only
8.	1366x768	47.720	59.799	84.75	WXGA	XGA only

8. RGB input (DTV)

No	Resolution	H-freq(kHz)	V-freq.(kHz)	Pixel clock(MHz)	Proposed	Remarks
1.	720x480	31.47	59.94	27.000	SDTV 480P	
2.	720x480	31.50	60.00	27.027	SDTV 480P	
3.	720x576	31.25	50.00	27.000	SDTV 576P 50Hz	
4.	1280x720	44.96	59.94	74.176	HDTV 720P	
5.	1280x720	45.00	60.00	74.250	HDTV 720P	
6.	1280x720	37.50	50.00	74.25	HDTV 720P 50Hz	
7.	1920x1080	33.72	59.94	74.176	HDTV 1080I	
8.	1920x1080	33.75	60.00	74.250	HDTV 1080I	
9.	1920x1080	28.125	50.00	74.250	HDTV 1080I 50Hz	

9. HDMI input (DTV)

No	Resolution	H-freq(kHz)	V-freq.(kHz)	Pixel clock(MHz)	Proposed	Remarks
1.	720x480	15.75	60.00	13.514	SDTV, DVD 480I(525I)	
2.	720x480	15.73	59.94	13.500	SDTV, DVD 480I(525I)	
3.	720x576	15.625	50.00	13.500	SDTV, DVD 576I(625I), 50Hz	
4.	720x480	31.47	59.94	27.000	SDTV 480P.	
5.	720x480	31.50	60.00	27.027	SDTV 480P	
6.	720x576	31.25	50.00	27.000	SDTV 576P 50Hz	
7.	1280x720	44.96	59.94	74.176	HDTV 720P	
8.	1280x720	45.00	60.00	74.250	HDTV 720P	
9.	1280x720	37.50	50.00	74.25	HDTV 720P 50Hz	
10.	1920x1080	33.72	59.94	74.176	HDTV 1080I	
11.	1920x1080	33.75	60.00	74.250	HDTV 1080I	
12.	1920x1080	28.125	50.00	74.250	HDTV 1080I 50Hz	

10. SET factoring condition

No	Item	Setting	Remarks		
1.	Station	Auto Programme	System	BG	
			Storage from	1	
			Search	To start	
		Manual Programme	Storage	1	
			System	BG	
			Band	V/UHF	
			Channel	69	
			Fine	◀ / ▶	
			Search	◀ / ▶	
			Name	-----	
		Programme Edit	To set		
		Favorite programme	-- -----		
Ch memory	TBD		TBD		
2.	Picture	PSM	Dynamic		
		CSM	Normal	For ZJ	
			Cool	For TJ, CJ	
				For MJ	
		XD	Auto		
		Advanced	Cinema : Off		
			Black Level : Low		
Reset					
3.	Sound	SSM	Flat		
		AVL	Off		
		TV Speaker	On		
4.	Time	Clock	--: --		
		Off Time	--: --		
			Off		
			On Time	--: --	
		PR 1			
		Vol. 30			
		Off			
Auto Sleep	Off				
5.	Special	Language	English	Following Buyer's demand, PR	
		Child Lock	Off		
		Set ID	1		
		XD Demo	To Start		
6.	Screen	Auto Config.		Available For RGB-PC mode	
		Manual Config.	Phase	0	Available For RGB-PC mode
			Clock	0	
			H-Position	0	Available For RGB mode
			V-Position	0	
		XGA Mode	1024x768	Available for RGB-PC XGA 60Hz	
		ARC	16:9		
Reset	To set				

11. Mechanical Specification

11.1 26LC2R

No	Item		Content				Remark
1.	Product		Width	Length	Height	Unit	
	Dimension	Before Packing	681	235	550	mm	SET(With Stand)
		After Packing	749	275	640	mm	
2.	Product	Only SET	16.8			Kg	
	Weight	With BOX	18.9			Kg	

11.2 32LC2R

No	Item		Content				Remark
1.	Product		Width	Length	Height	Unit	
	Dimension	Before Packing	811	235	630	mm	SET(With Stand)
		After Packing	896	300	720	mm	
2.	Product	Only SET	22			Kg	
	Weight	With BOX	25.5			Kg	

ADJUSTMENT INSTRUCTION

1. Application Range

This spec sheet is applied all of the 26/32" LCD TV, LP61A/C, LN61A chassis (HURRICANE 3 MIDDLE) by manufacturing LG TV Plant all over the world.

2. Specification

- 2.1 Because this is not a hot chassis, it is not necessary to use an isolation transformer. However, the use of isolation transformer will help protect test instrument.
- 2.2 Adjustment must be done in the correct order.
- 2.3 The adjustment must be performed in the circumstance of $25 \pm 5^\circ\text{C}$ of temperature and $65 \pm 10\%$ of relative humidity if there is no specific designation.
- 2.4 The input voltage of the receiver must keep 100~220V, 50/60Hz.
- 2.5 Before adjustment, execute Heat-Run for 30 minutes at RF no signal.

3. Adjustment items

3.1 PCB assembly adjustment items

- Download the VCTP main software (IC601, VCPT)
- Channel memory (IC603, EEPROM)
- Colorcarrier Adjustment

3.2 SET assembly adjustment items

- DDC Data input.
- Adjustment of White Balance.
- Factoring Option Data input.

4. PCB assembly adjustment

4.1 PCB assembly adjustment method (Using VCTP Download program)

4.1.1. Download program installation

(1) Extract a Zip file

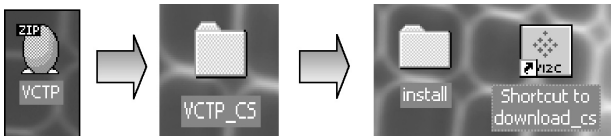

(2) Visual I2C & LPT Driver Installation

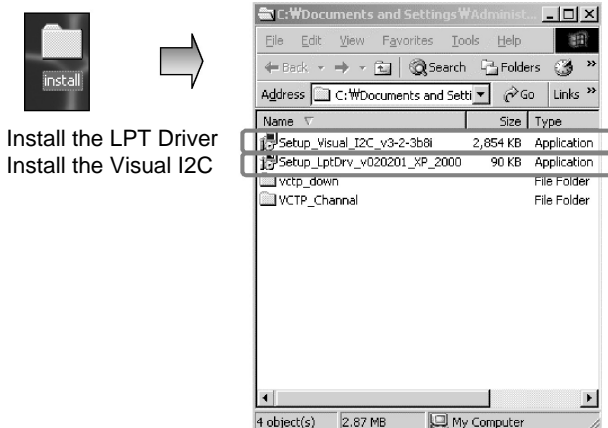

LPT Port Driver (LptDrv) Setups : Program Files > Micronas > Visual I2C > Port_Driver

*Use for Windows 95/98 : Setup_LptDrv_v0104_9x.exe

*Use for Windows 2000/XP : Setup_LptDrv_v0202_XP_2000.exe

*Use for Windows NT : Setup_LptDrv_v0104_NT.exe

(3) Verification (Start > Programs > Micronas > Visual I2C or LptDrv)

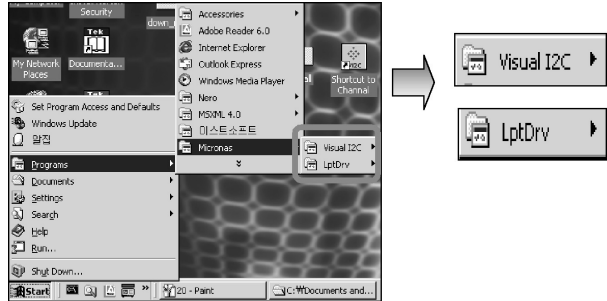

(4) LPT delay setting (File > Preference > LPT preferences)

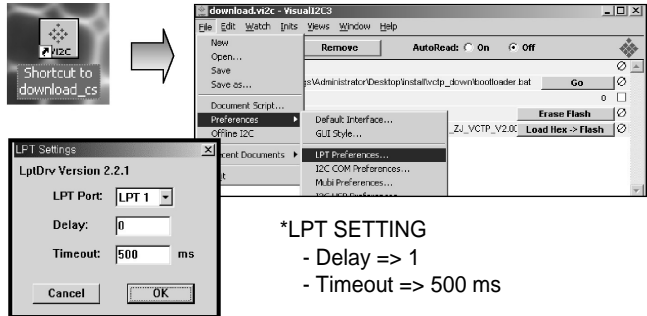

(5) Exchange the bootloader.bat file

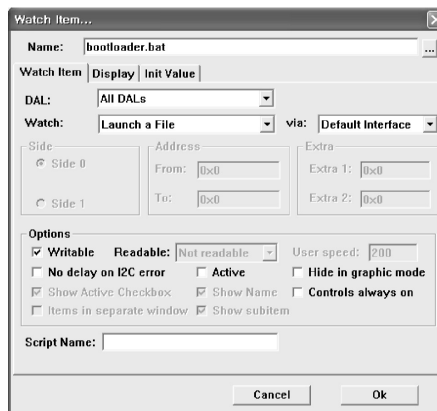
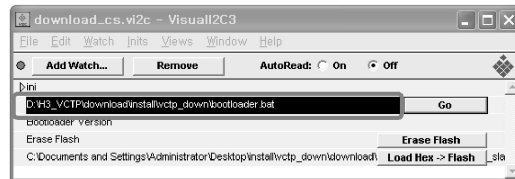

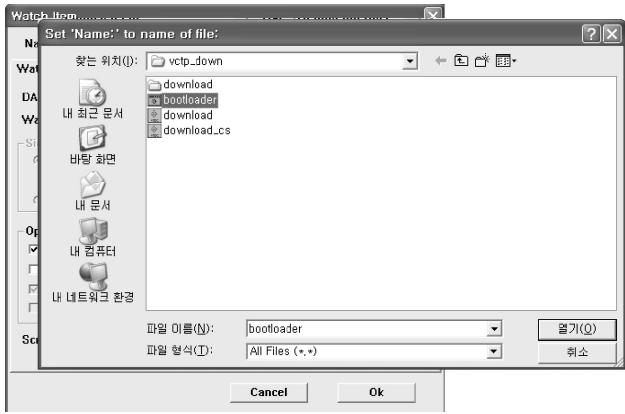

=> Select the "Bootloader.bat" file(install > VCTP_download > Bootloader)
=> Push "OK"

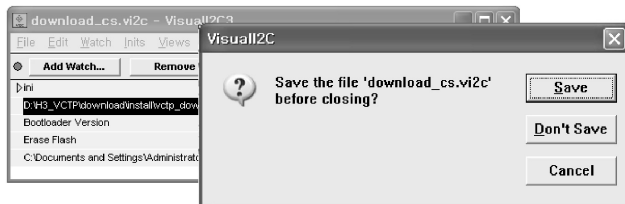

=> Finish the program, after saving the file "download_cs.vi2c" (if you click [X], the message appears automatically)

4.1.2. S/W program download

- Preliminary steps

4.1.2.1 Download method 1 (PCB Ass'y)

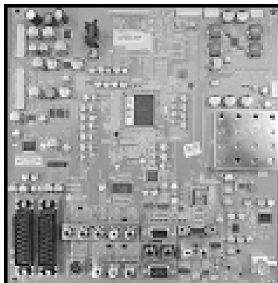

(1) Connect the download jig to D-sub jack

(2) Execute 'Download.vi2c' program in PC, then a main window will be opened

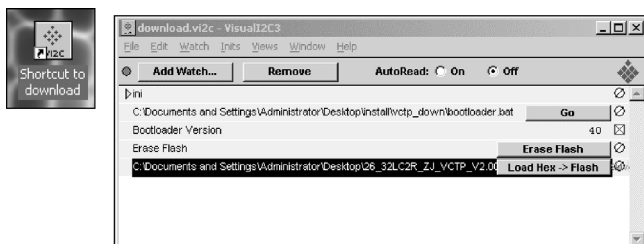

(3) Double click the blue box and confirm "Bootloader Version" as 40.

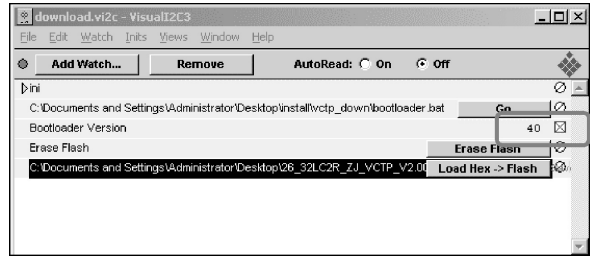

(4) Click the "Erase Flash" button

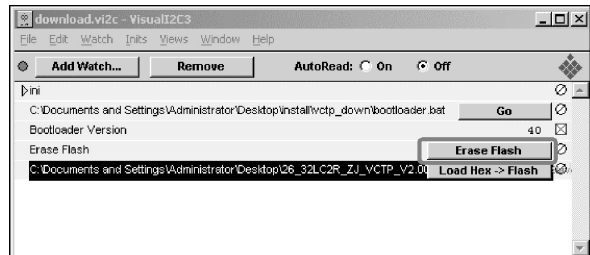

(5) Double click the download file low, then "edit" window will be opened

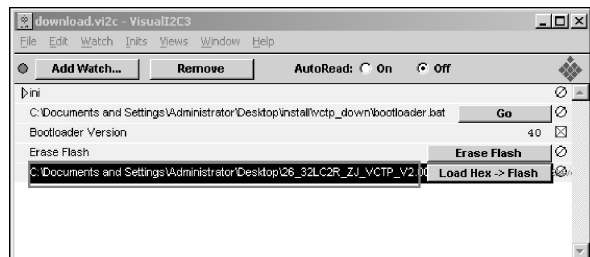

(6) Click the choice button in the "edit window", then "file choice window" will be opened

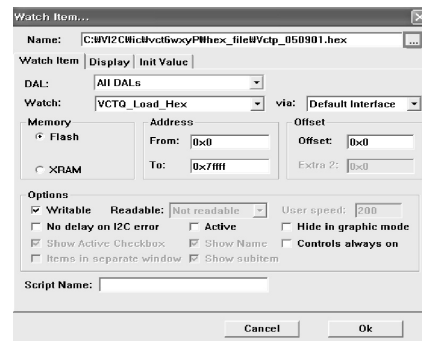

(7) Choose the Hex file in folder and execute downloading with click "open" button.

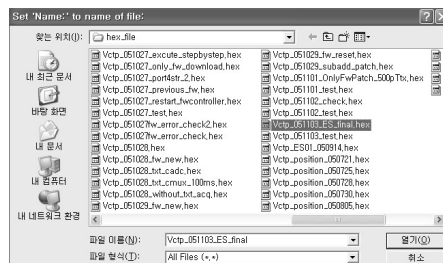

(8) Click OK button at the "edit window"

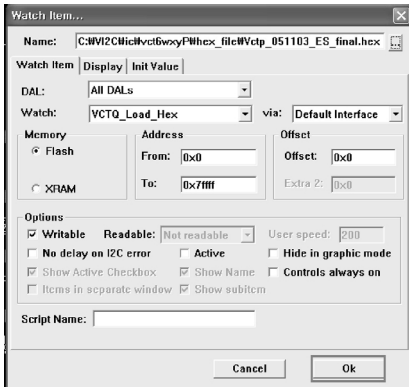

(9) Under Downloading process

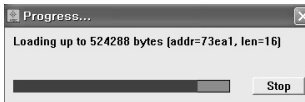

(10) If download is failed, for example "No acknowledge from slave". Execute download again from(1)

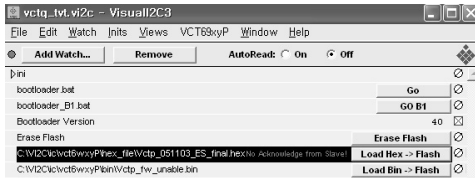

(2) Supply the power (Stand-by 5V) and wait for 3 seconds.

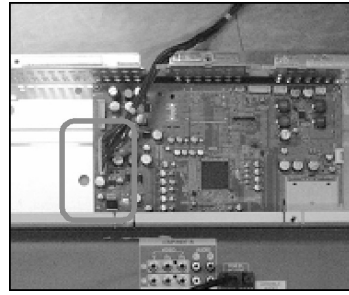

(3) Push the S/W off (Disconnect SCL to GND using switch at jig)

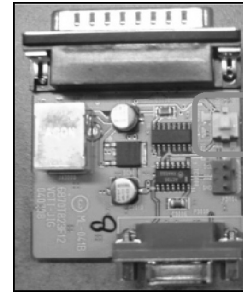

(4) Execute 'Download.vi2c' program in PC, then a main widow will be opened.



Double click

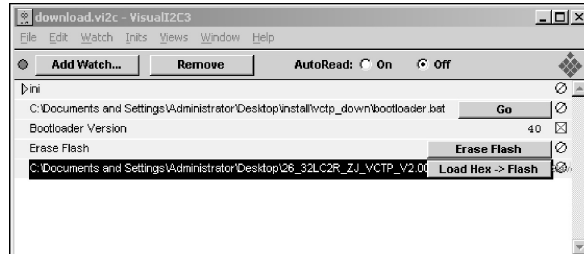

(5) Double click the blue box and confirm "Bootloader Version" as 40.



4.1.2.2 Download method 2 (AV Plate Ass'y)

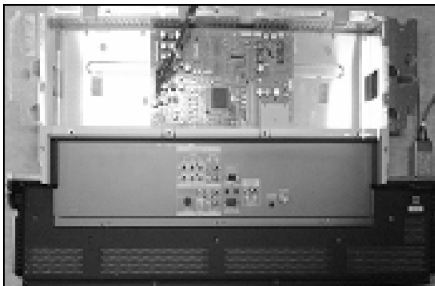

(1) Push S/W 'ON' (connect SCL to GND using switch at Jig) and connect the download jig to D-sub jack

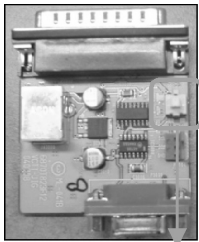

Push S/W

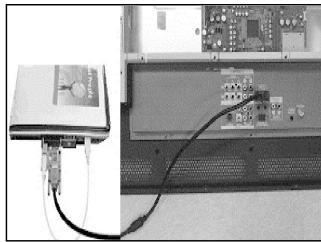

(6) Click the "Erase Flash" button

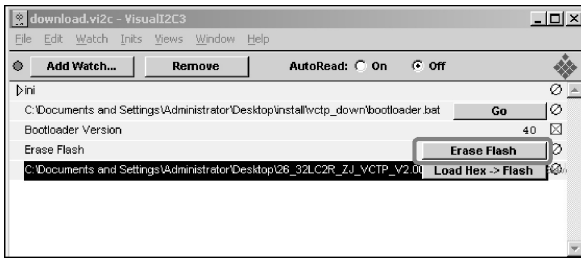

(7) Double click the download file low then, "edit" window will be opened

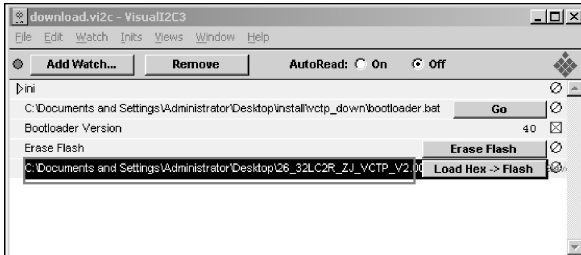

(8) Click the choice button in the "edit window", then "file choice window" will be opened

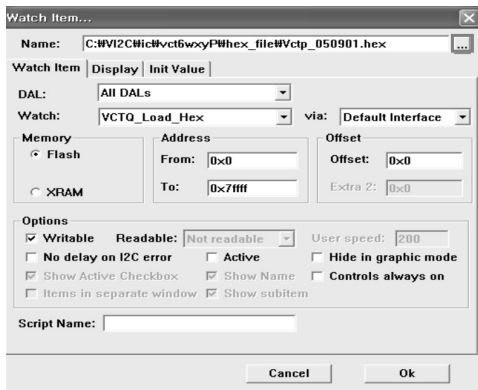

(9) Choose the Hex file in folder and execute downloading with click "open button"

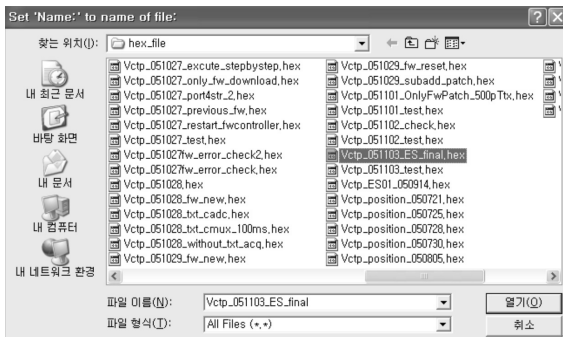

(10) Click OK button at the "edit window"

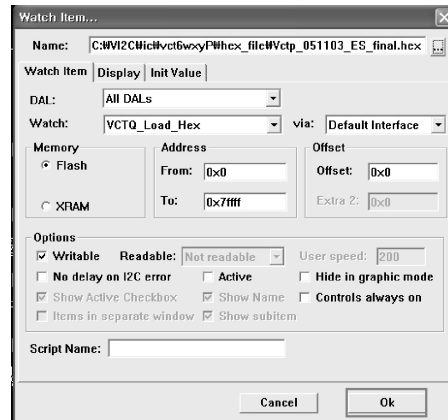

(11) Under Downloading progress

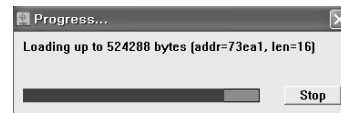

(12) If download is failed, for example "No acknowledge from slave", execute download again from (1)

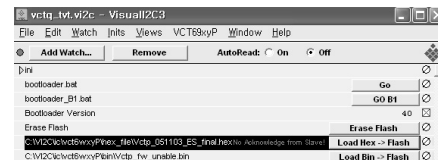

4.1.2.2 Download method 3 (SET)

(1) Push the "Tilt" button in an Adjust Remocon Then the LCD TV will change a "slave mode"

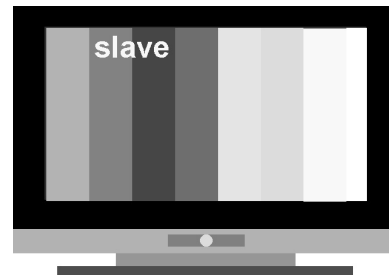

(2) Connect Zig to TV using a D-sub cable

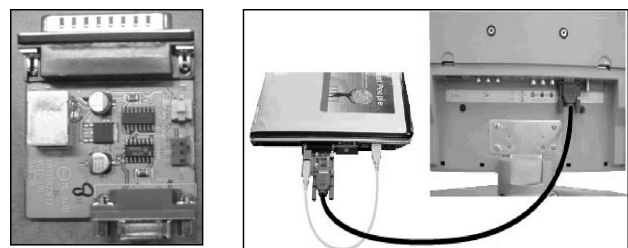

(3) Execute 'Download_CS.vi2c' program in PC, then a main widow will be opened.



Double click

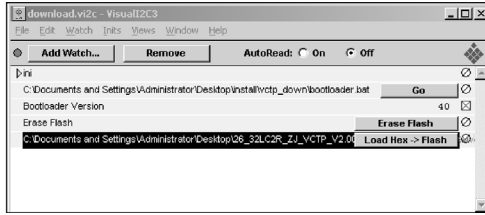

(4) Click "GO" button

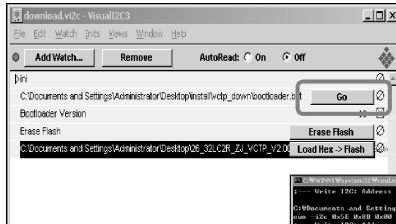

If you don't push the "go", the Hex file would not be downloaded although the download proceeds normally at first glance

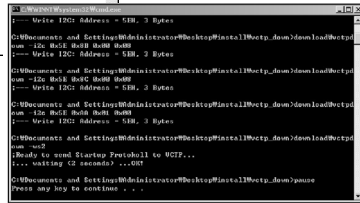

(5) Double click the blue box and confirm "Bootloader Version" as 40.

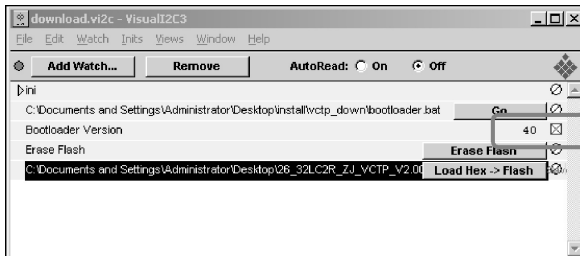

(6)Click the "Erase Flash" button

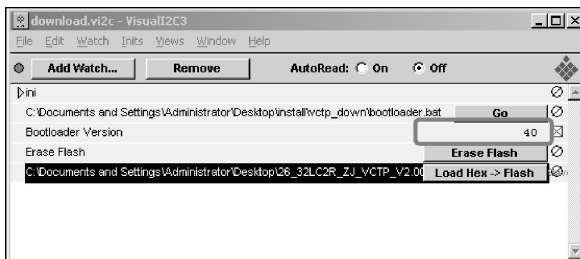

(7) Double click the download file low then, "edit" window will be opened

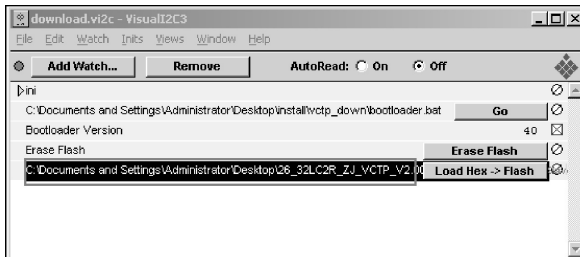

(8) Chk the choice button I n the "edit window", then "file choice window" will be opened

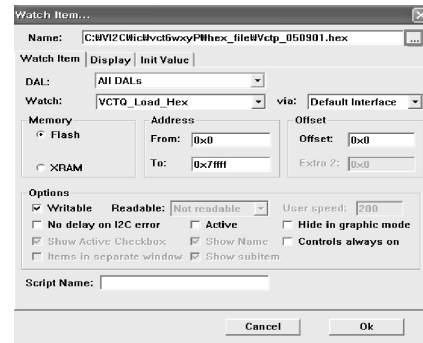

(9) Choose the Hex file in folder and execute downloading with click "open button"

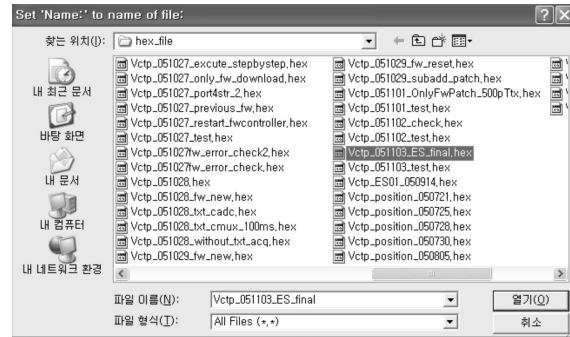

(10) Click OK button at the "edit window"

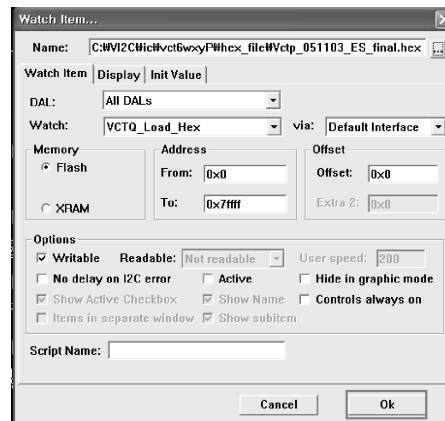

(11) Under Downloading progress

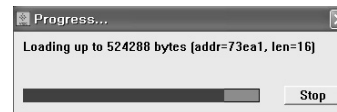

(12) if download is failed, for example "No acknowledge from slave", execute download again from (1)

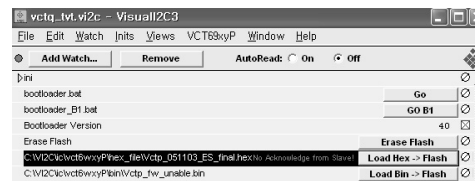

4.1.2. S/W program download

- (1) Connect the download jig to D-sub jack
- (2) Execute 'Channel.vi2c' program in PC, then a main widow will be opened.



- (3) Push the button change and select the Channel memory data

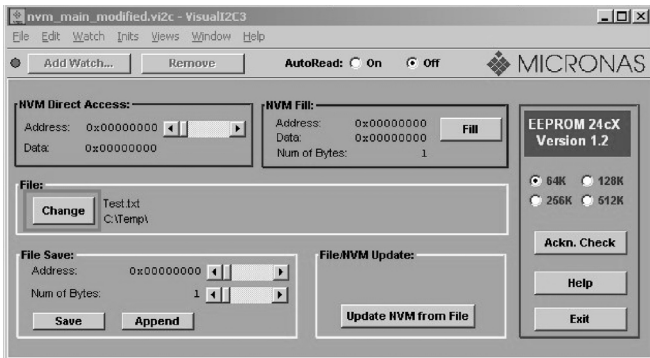

- (4) Check the communication is OK or not.
=> Push the Read area (Ackn. Check) and check Cyan area is OK message.

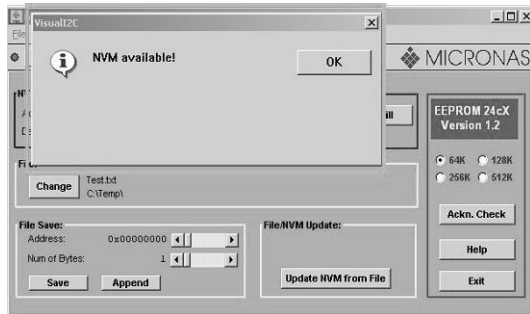

- (5) Push the Update NVM from File

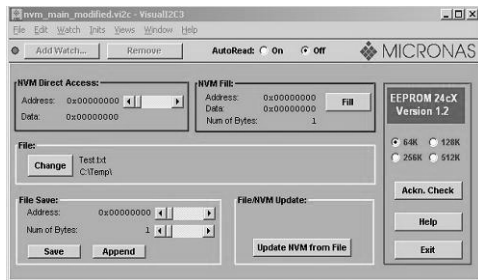

4.1.3. Colorcarrier Adjustment (inspection process)

- a. Tuning the RF signal
ZJ, TJ, CJ : PAL Philips Pattern (with Color Bar)
MJ : NTSC Digital Pattern (with Color Bar)

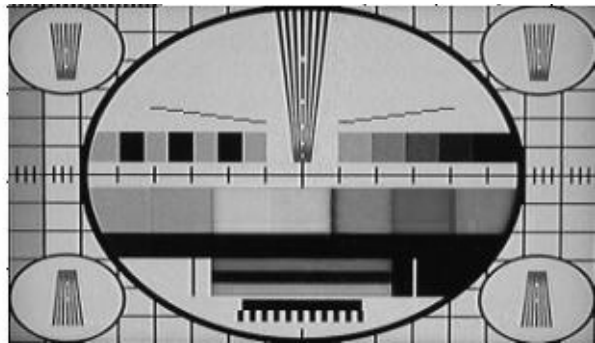
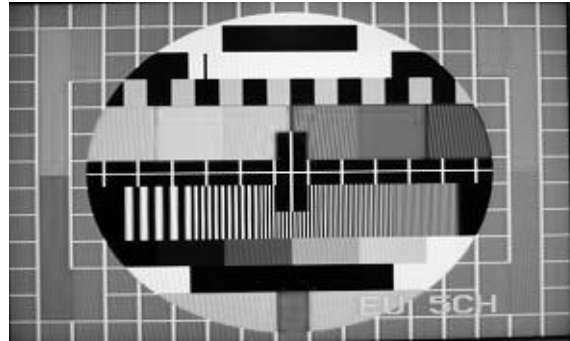

- b. push the "adj" key in the adjustment remocon.

4.2 SET assembly adjustment method

***Caution :** Each PCB assembly must be checked by check JIG set.(Because power PCB Assembly damages to LCD Module, especially be careful)

4.2.1 EDID(The Extended Display Identification Data) / DDC(Display Data Channel) download

- (1) Extract a Zip file

* Caution

- Use the proper signal cable for EDID Download

* Caution: - Never connect HDMI & D-SUB Cable at the same time.

- Use the proper cables below for EDID Writing

<EDID DATA Analog Set : 128bytes>

	0	1	2	3	4	5	6	7	8	9	A	B	C	D	E	F
00	00	FF	FF	FF	FF	FF	FF	00	1E	6D	(a)				(b)	
10	(c)	01	03	08	46	27	78	0A	D9	E0	A3	57	49	9C	25	
20	11	49	4B	A1	08	00	31	40	01	01	01	45	40	01	01	
30	61	40	01	01	01	01	1B	21	50	A0	51	00	1E	30	48	88
40	35	00	BC	88	21	00	00	1C	4E	1F	00	80	51	00	1E	30
50	40	80	37	00	BC	88	21	00	00	18	00	00	00	FD	00	38
60	3F	1F	32	09	00	0A	20	20	20	20	20	20	00	00	00	FC
70	00					(d)					0A	20	20	20	00	(e)

< EDID DATA HDMI Set : 256bytes>

	0	1	2	3	4	5	6	7	8	9	A	B	C	D	E	F
00	00	FF	FF	FF	FF	FF	00	1E	6D	(a)					(b)	
10	0F	48	01	03	80	5C	34	96	0A	F3	30	A7	54	42	AA	26
20	0F	48	4C	00	00	00	01	01	01	01	01	01	01	01	01	01
30	01	01	01	01	01	01	8C	0A	00	8A	20	E0	2D	10	10	3E
40	96	00	C4	8E	21	00	00	18	00	00	00	FC	00			
50			(d)				0A	20	20	20	00	00	00	FD	00	2D
60	41	19	32	08	00	0A	20	20	20	20	20	20	00	00	00	00
70	00	00	00	00	00	00	00	00	00	00	00	00	00	00	01	(e)
	0	1	2	3	4	5	6	7	8	9	A	B	C	D	E	F
00	02	03	1C	72	23	09	07	02	49	07	16	81	03	05	14	13
10	12	04	83	01	00	00	65	03	0C	00	10	00	01	1D	80	18
20	71	1C	16	20	58	2C	25	00	C4	8E	21	00	00	9E	01	1D
30	80	D0	72	1C	16	20	10	2C	25	80	C4	8E	21	00	00	9E
40	01	1D	00	BC	52	D0	1E	20	B8	28	55	40	C4	8E	21	00
50	00	1E	8C	0A	D0	90	20	40	31	20	0C	40	55	00	C4	8E
60	21	00	00	18	01	1D	00	72	51	D0	1E	20	6E	28	55	00
70	C4	8E	21	00	00	1E	00	00	00	00	00	00	00	00	00	2F

=> Detail EDID Options are below(a, b, c, d, e)

a. Product ID

Model Name	Product ID		
	Dec	Hex	EDID table
26C2R	22045(A)	561D	1D56
	22046(B)	561E	1E56
32LC2R	30057(A)	7569	6975
	30058(D)	756A	6A75
37LC2R	30059(A)	756B	6B75
	30060(D)	756C	6C75

b. Serial No: Controlled on production line

c. Month, Year: Controlled on production line:

ex) Montly: '03' => '03'

Year: '2005' => '0F'

d. Model Name(Hex) :

Model Name	Model Name(HEX)								
26LC2R-TJ	32	36	4C	43	32	52	2D	54	4A
32LC2R-TJ	33	32	4C	43	32	52	2D	54	4A

e. Checksum: Changeable by total EDID data

4.3 Adjustment of White Balance

* In case of White Balance rework, you have to RESET the previous White Balance data. (You can do that by pushing the "IN-START" key in adjust remocon and reset)

4.3.1 Required Equipment

- Remote controller for adjustment
- Color Analyzer (CA-110 or CA-210 or same product; ch : 9)
- Auto W/B adjustment instrument (only for Auto adjustment)
- AV Pattern Generator

ZJ, TJ, CJ – model : 202 (PAL-BDGI), pattern:78 (216 Gray)

MJ – model : 207 (NTSC-J), pattern : 78 (216 Gray)

4.3.2 Connecting diagram of equipment for measuring (For Automatic Adjustment)

[Push the "POWER ON" key at the Adjust Remocon before Adjustment of W/B, the Baud rate & PSM, CSM will change 115200bps, Standard (MJ: Optimum), Normal]

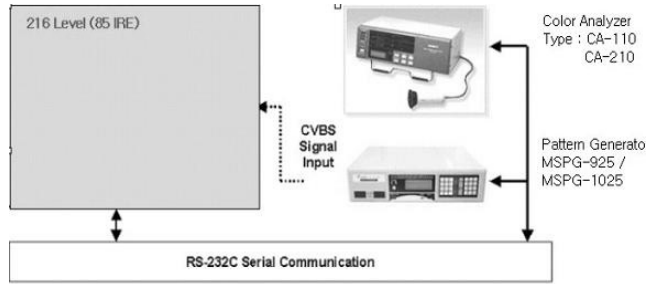

4.3.3 Adjustment of White Balance for Manual adjustment

- Operate the zero-calibration of the CA-110 or CA-210, then stick sensor to LCD module when you adjust.
- For manual adjustment, it is also possible by the following sequence

- 1) Select RF no signal by pressing "POWER ON" key on remote control for adjustment then operate heat run more than 15 minutes.
- 2) As below Fig. 7, Supply 216Level (85 IRE) Gray pattern to Video input.
 - 26/32LC2R-ZJ : AV3 or AV4(Input 50Hz)
 - 26/32LC2R-TJ : AV1or AV2(Input 50Hz),
 - 26/32/37LC2R-CJ : AV1 or AV2 (Input 50Hz)
 - 26,32LC2R-MJ : VIDEO1 or VIDEO2 (Input 60Hz)
- 3) Press the POWER ON KEY on R/C for converting input mode.
- 4) Enter the White Balance adjustment mode by pressing the IN-START key (White Balance) on R/C.
- 5) Stick sensor to center of the screen and select each items (Red/Green/Blue Gain and Offset) using ▲/▼(CH +/-) key on R/C..
- 6) Adjust Only High Light with R Gain / B Gain using ◀/▶ (VOL + / -) key on R/C.
- 7) Adjust it until color coordination becomes as below. (Initially, R/G/B gain and R/G/B offset values are fixed as below)

Red Gain : 80 , Green Gain : 80 , Blue Gain : 80
 Red Offset : 80, Green Offset : 80 , Blue Offset : 80

* Target Value [PSM: Standard(ZJ, TJ, CJ), Optimum(MJ), CSM: Normal]

-Normal (9300K) x ; 0.283±0.003 y ; 0.298±0.003

=> Reference Value(Automatically fixed)

-Cool(11000K): x:0.274±0.003, y: 0.286±0.003

-Warm(7200K) : x:0.303±0.003, y: 0.319±0.003

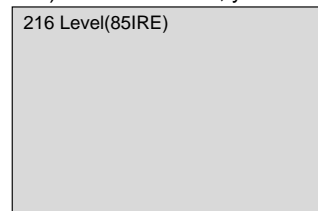

* Pattern for Adjustment of White Balance

- 8) When adjustment is completed, Exit adjustment mode using EXIT key on R/C.

7. Shipping Conditions

No	Item		Condition	Remark	
1	Power		Off		
2	Volume Level		30		
3	Main Picture Input		TV		
4	Main Last Channel		Pr 01		
5	Mute		Off		
6	ARC		16 : 9		
7	Station	Auto Programme			
		Manual Programme			
		Programme Edit			
		Favorite Programme	None		
8	Picture	PSM	Dynamic		
		Dynamic	Contrast	100	
			Brightness	50	
			Colour	50	
			Sharpness	50	
		CSM	Normal		
		XD	Auto		
		Advanced			
Reset					
9	Sound	SSM	Flat		
			Off		
		AVL	Off		
		Balance	0		
			50		
			50		
Speaker	On				
10	Time	Clock	--:--	User control	
		Off time	Off		
		On time	Off		
		Auto sleep	Off		
11	Special	Language	English	Area management	
		Child Lock	Off		
		Set ID	1		
		XD Demo	To start		
12	Screen	Auto config.	Variable by each mode		
		Manual config.			
		XGA/VGA mode			
		ARC			
		PFP Transparency			
		Reset			

SVC REMOCON

NO	KEY	FUNTION	REAMARK
1	POWER	To turn the TV on or off	
2	POWER ON	To turn the TV on automatically if the power is supplied to the TV. (Use the POWER key to deactivate): It should be deactivated when delivered.	
3	MUTE	To activate the mute function.	
4	P-CHECK	To check TV screen image easily.	Shortcut keys
5	S-CHECK	To check TV screen sound easily	Shortcut keys
6	ARC	To select size of the main screen (Normal, Spectacle, Wide or Zoom)	Shortcut keys
7	CAPTION	Switch to closed caption broadcasting	
8	TXT	To toggle on/off the teletext mode	
9	TV/AV	To select an external input for the TV screen	
10	TURBO SOUND	To start turbo sound	
11	TURBO PICTURE	To start turbo picture	
12	IN-START	To enter adjustment mode when manufacturing the TV sets.	Use the AV key to enter the screen W/B adjustment mode.
		To adjust the screen voltage (automatic): In-start → mute → Adjust → AV(Enter into W/B adjustment mode)	
		W/B adjustment (automatic): After adjusting the screen → W/B adjustment → Exit two times (Adjustment completed)	
13	ADJ	To enter into the adjustment mode. To adjust horizontal line and sub-brightness.	
14	MPX	To select the multiple sound mode (Mono, Stereo or Foreign language)	
15	EXIT	To release the adjustment mode	
16	APC(PSM)	To easily adjust the screen according to surrounding brightness	
17	ASC(SSM)	To easily adjust sound according to the program type	
18	MULTIMEDIA	To check component input	Shortcut keys
19	FRONT-AV	To check the front AV	Shortcut keys
20	CH±	To move channel up/down or to select a function displayed on the screen.	
21	VOL±	To adjust the volume or accurately control a specific function.	
22	ENTER	To set a specific function or complete setting.	
23	PIP CH-(OP1)	To move the channel down in the PIP screen. To use as a red key in the teletext mode	
24	PIP CH+(OP2)	To move the channel in the PIP screen To use as a green key in the teletext mode	
25	PIP SWAP(OP3)	To switch between the main and sub screens To use as a yellow key in the teletext mode	
26	PIP INPUT(OP4)	To select the input status in the PIP screen To use as a blue key in the teletext mode	
27	EYE	To set a function that will automatically adjust screen status to match the surrounding brightness so natural color can be displayed.	
28	MENU	To select the functions such as video, voice, function or channel.	
29	IN-STOP	To set the delivery condition status after manufacturing the TV set.	
30	STILL	To halt the main screen in the normal mode, or the sub screen at the PIP screen. Used as a hold key in the teletext mode (Page updating is stopped.)	
31	TIME	Displays the teletext time in the normal mode Enables to select the sub code in the teletext mode	
32	SIZE	Used as the size key in the PIP screen in the normal mode Used as the size key in the teletext mode	
33	MULTI PIP	Used as the index key in the teletext mode (Top index will be displayed if it is the top text.)	
34	POSITION	To select the position of the PIP screen in the normal mode Used as the update key in the teletext mode (Text will be displayed if the current page is updated.)	
35	MODE	Used as Mode in the teletext mode	
36	PIP	To select the simultaneous screen	
37	TILT	To adjust screen tilt	Shortcut keys
38	0~9	To manually select the channel.	

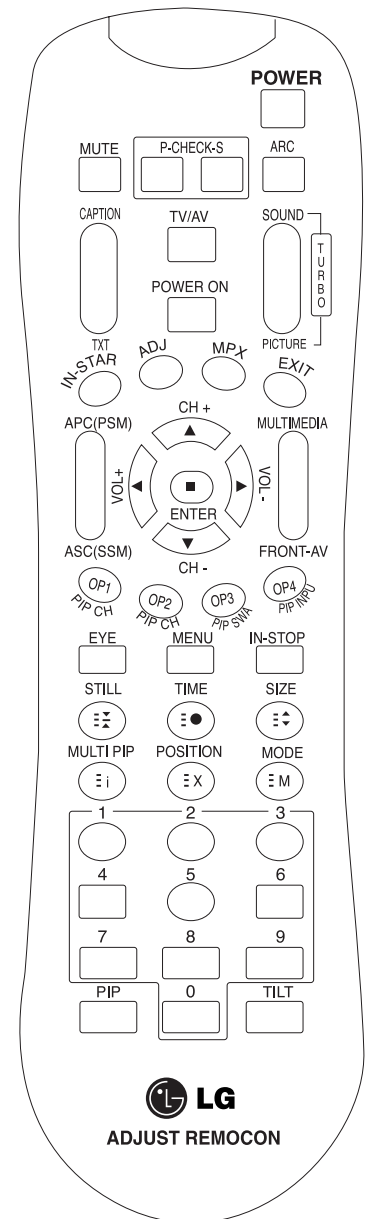

TROUBLESHOOTING

1. No power

(1) Symptom

- 1) Front LED is No light
- 2) The Set doesn't discharge little

(2) Check process

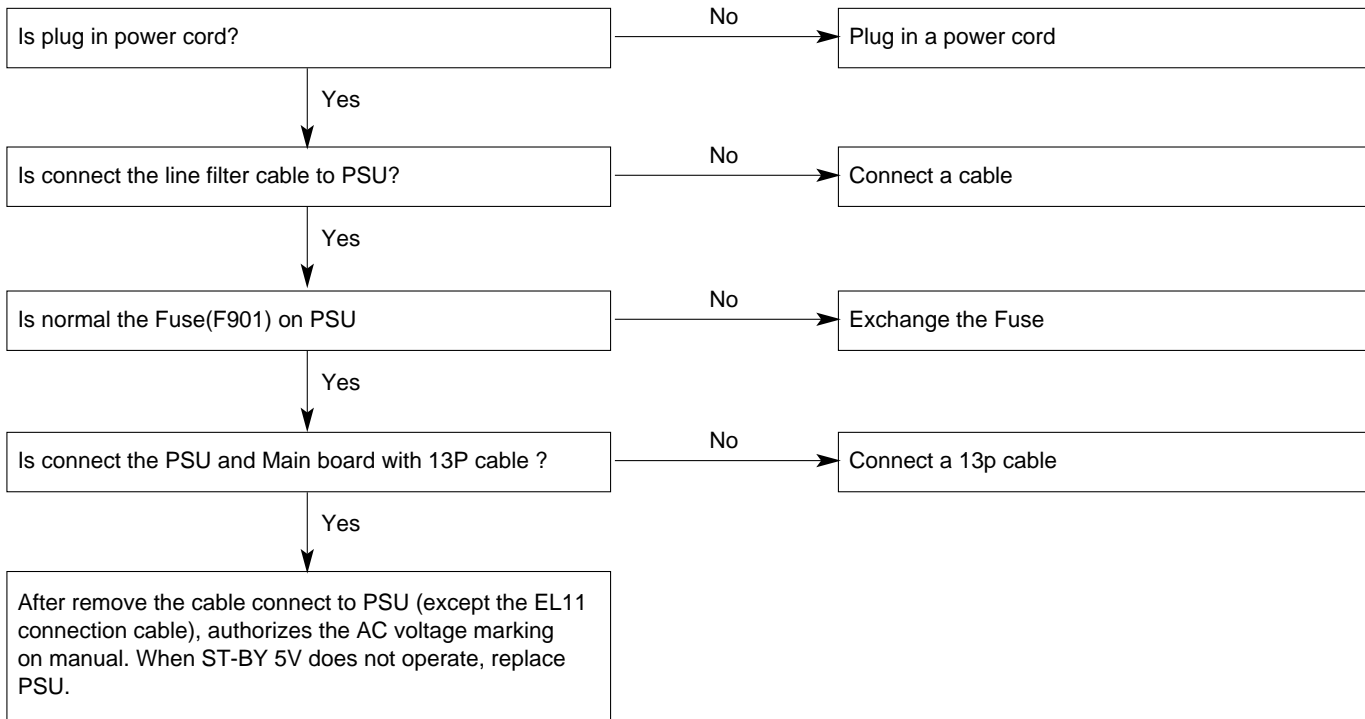

2. Cannot Power on

(1) Symptom

- 1) Front LED is Red, but doesn't change Green (Cannot turn on the SET)
- 2) Don't operate power on using a Remocon or Local key.

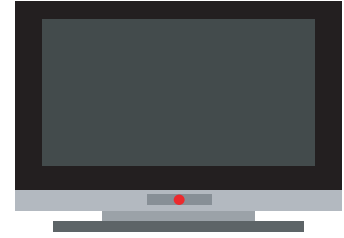

(2) Check process

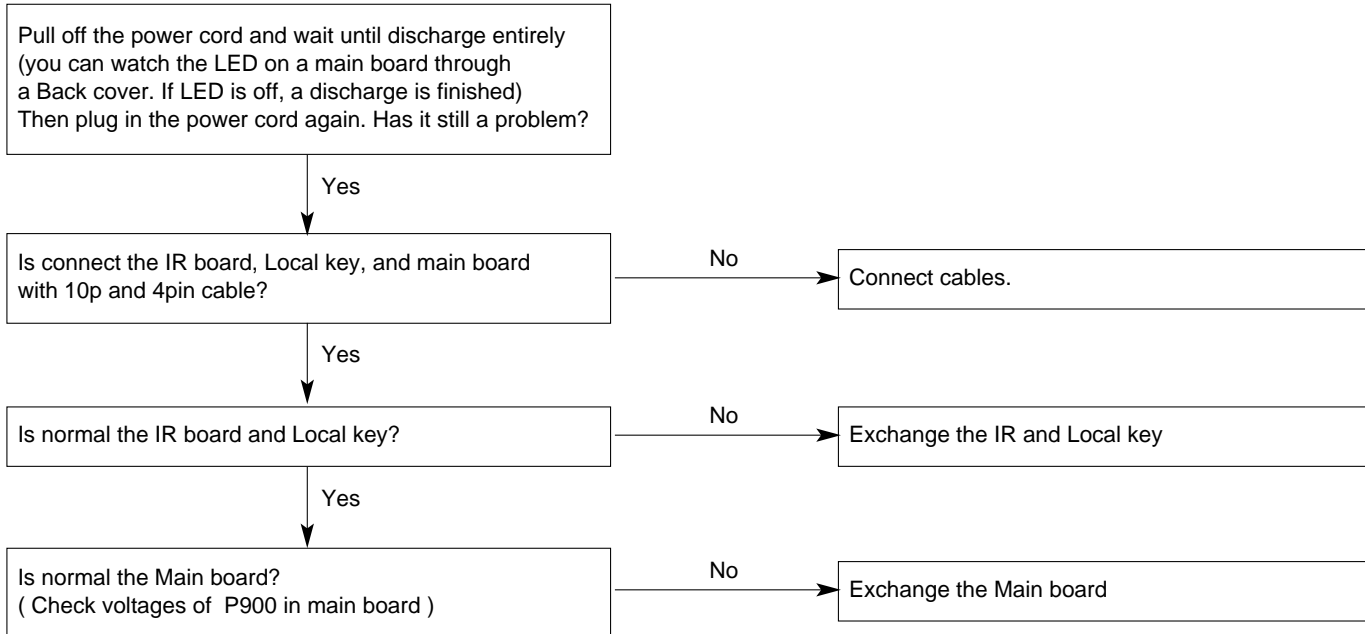

3. Protect mode

(1) Symptom

- 1) After once shining, it does not discharge minutely from module
- 2) The Relay falls down (The sound is audible "click")
- 3) The front LED turn Green to Red

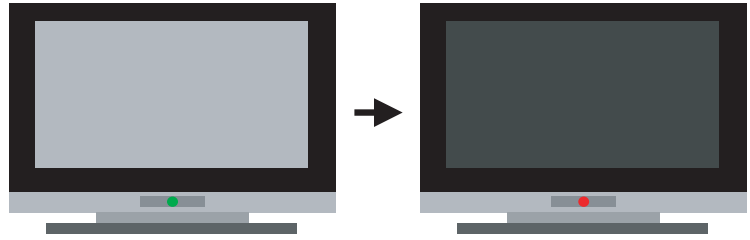

(2) Check process

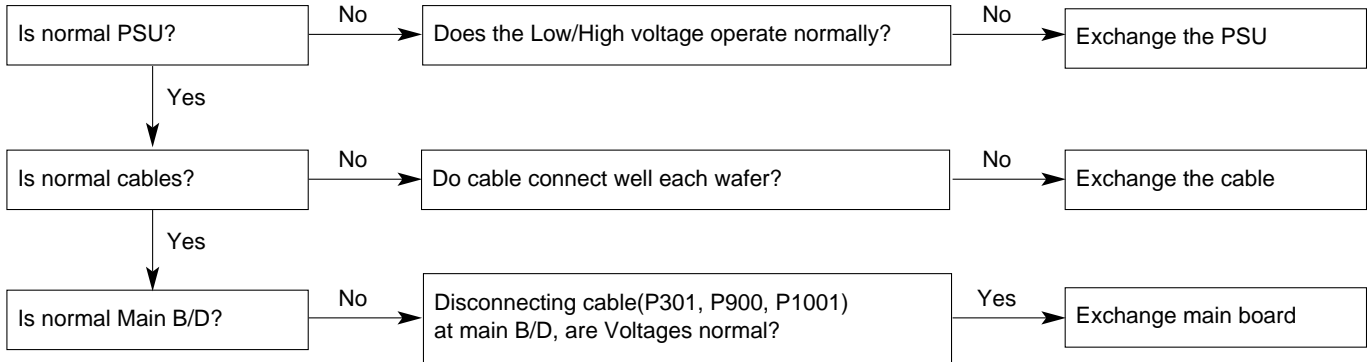

4. No raster

(1) Symptom

- 1) Front LED is Green
- 2) The Set doesn't discharge little



(2) Check process

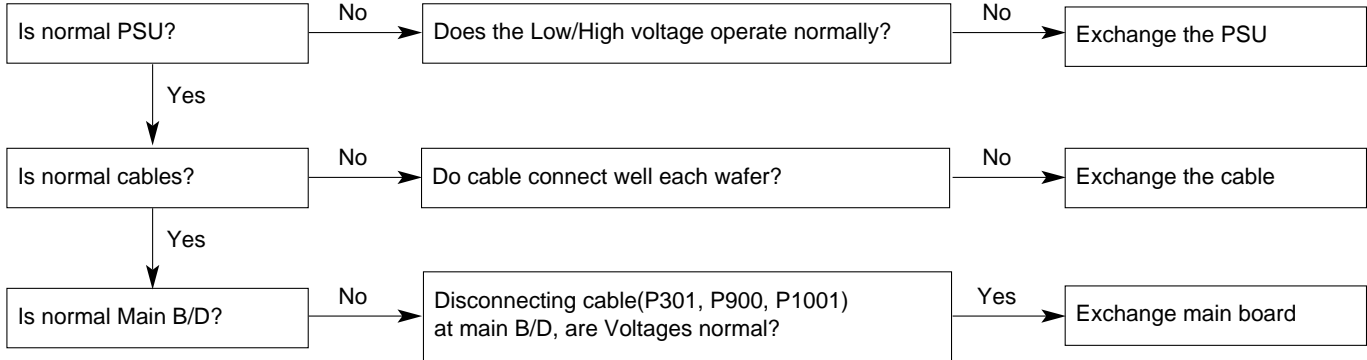

5. No Sound

(1) Symptom

- 1) Front LED is Green
- 2) The Set display a screen, but a sound doesn't output

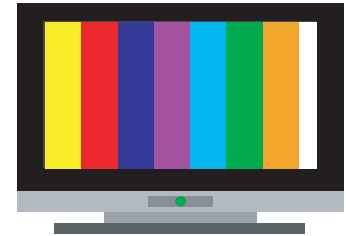

(2) Check process

1) Speaker part

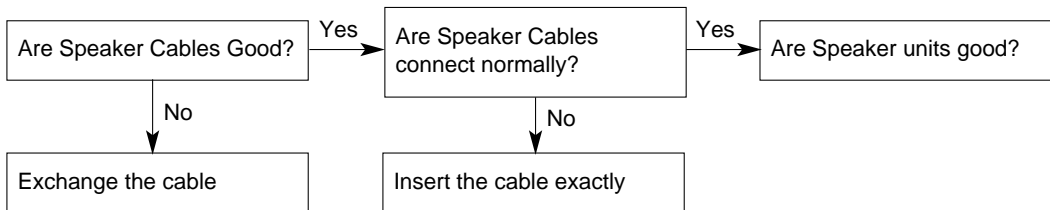

2) Main board part

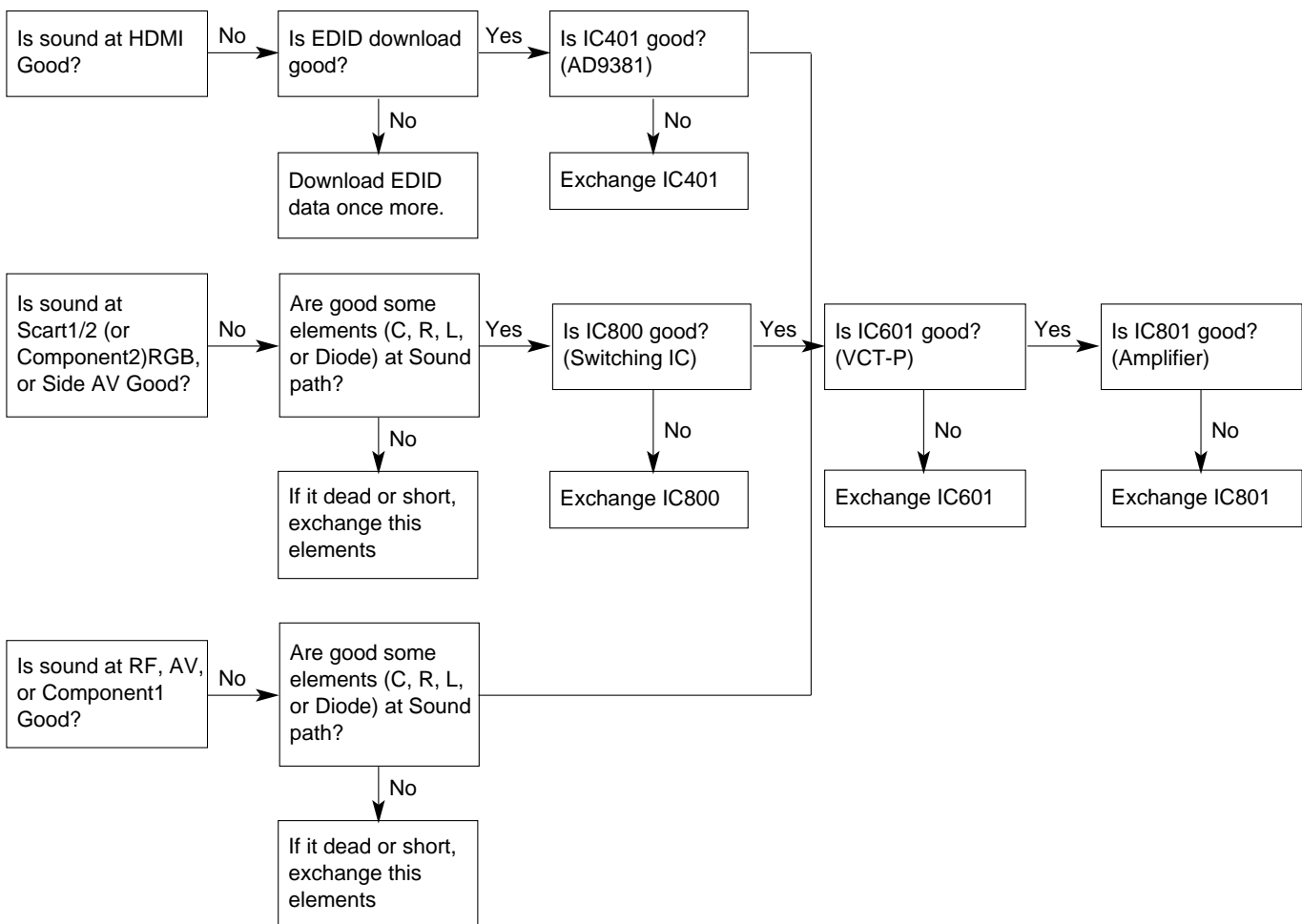

6. Display the screen abnormally

(1) Symptom

1) Display the screen abnormally at specific mode

(2) Check process

1) Noise appears at RF mode.

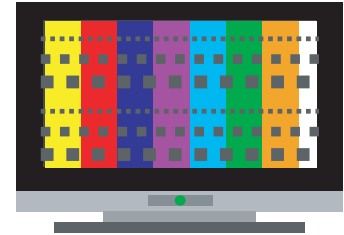
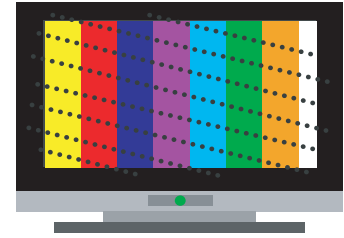
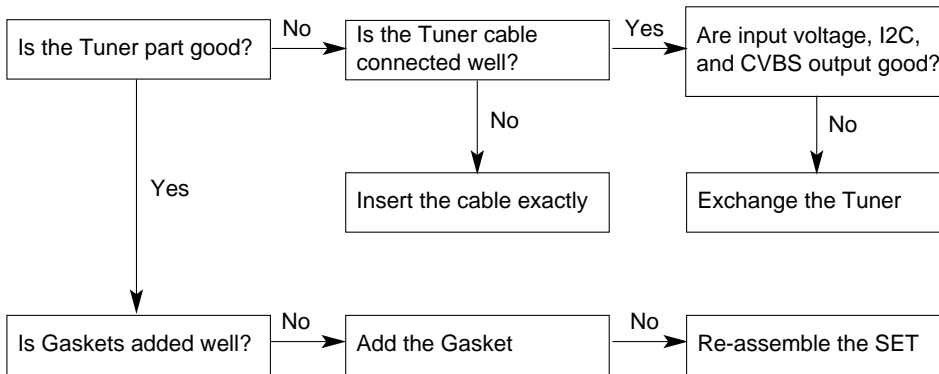

7. No picture

(1) Symptom

- 1) Some mode doesn't display.
- 2) Front LED is green
- 3) The set still discharge a little



(2) Check process

- 1) RF-mode doesn't display

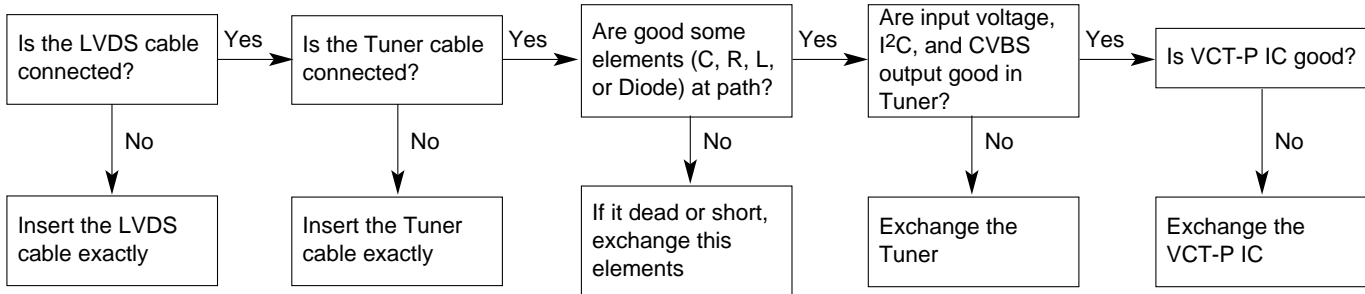

- 2) AV/Component-mode doesn't display

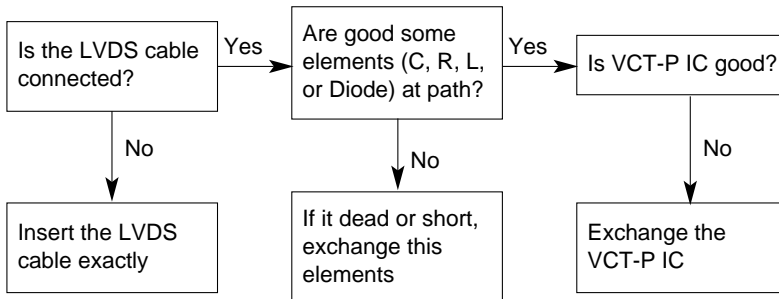

- 3) RGB/HDMI-mode doesn't

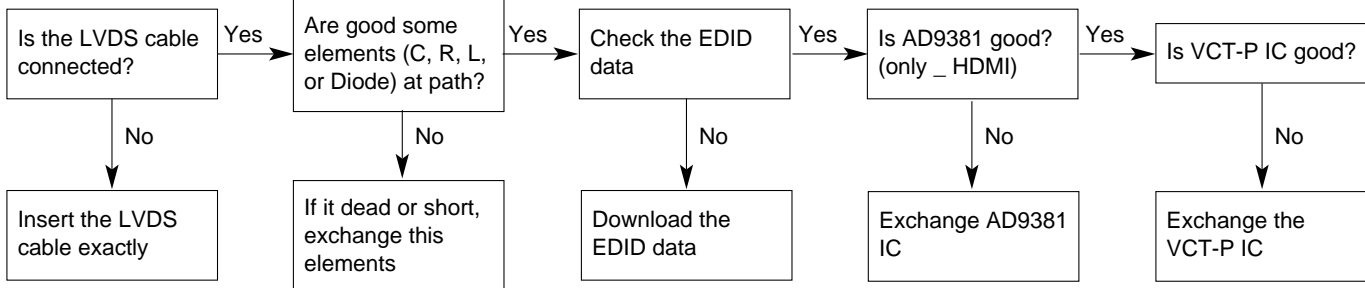

BLOCK DIAGRAM

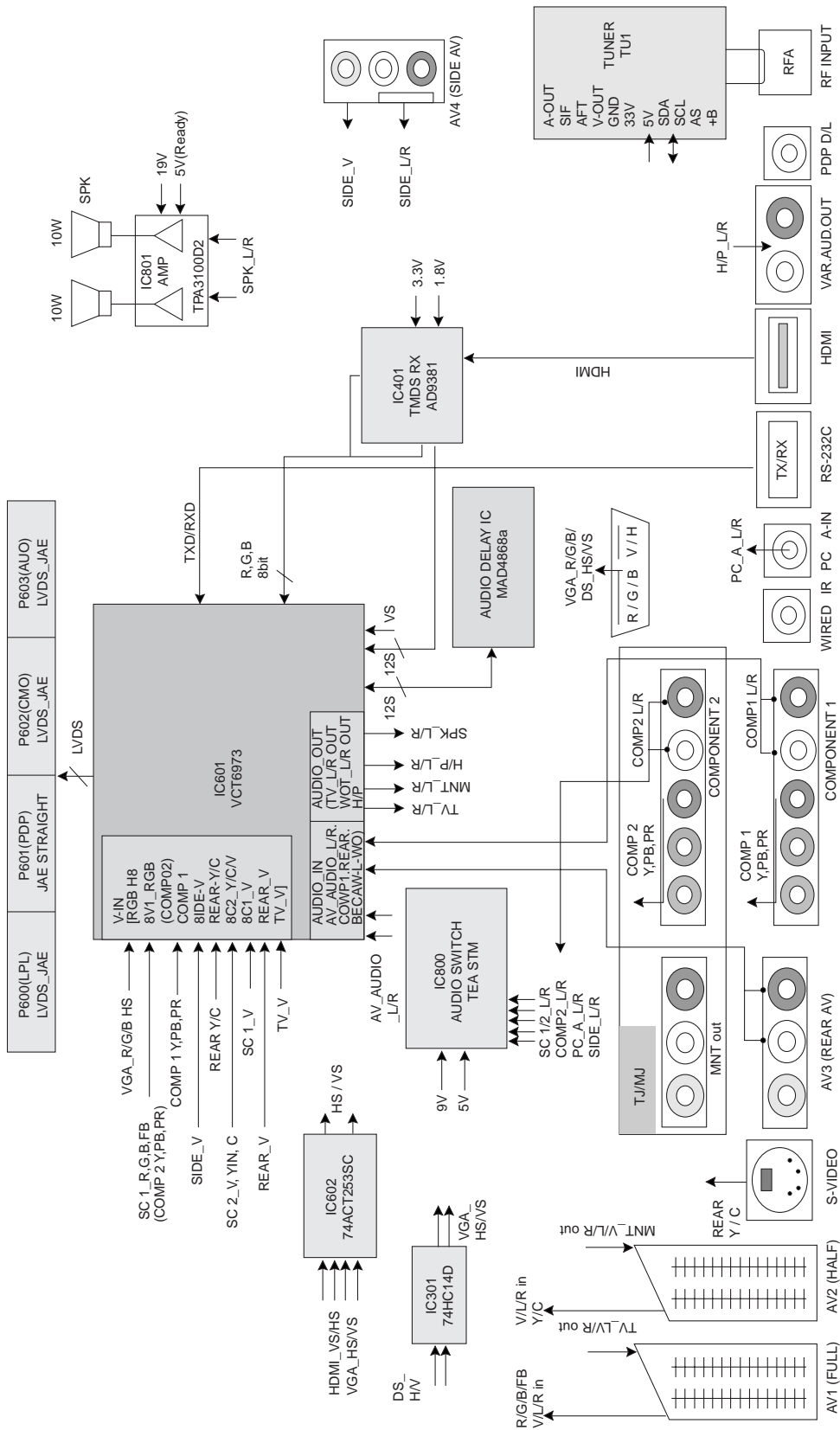

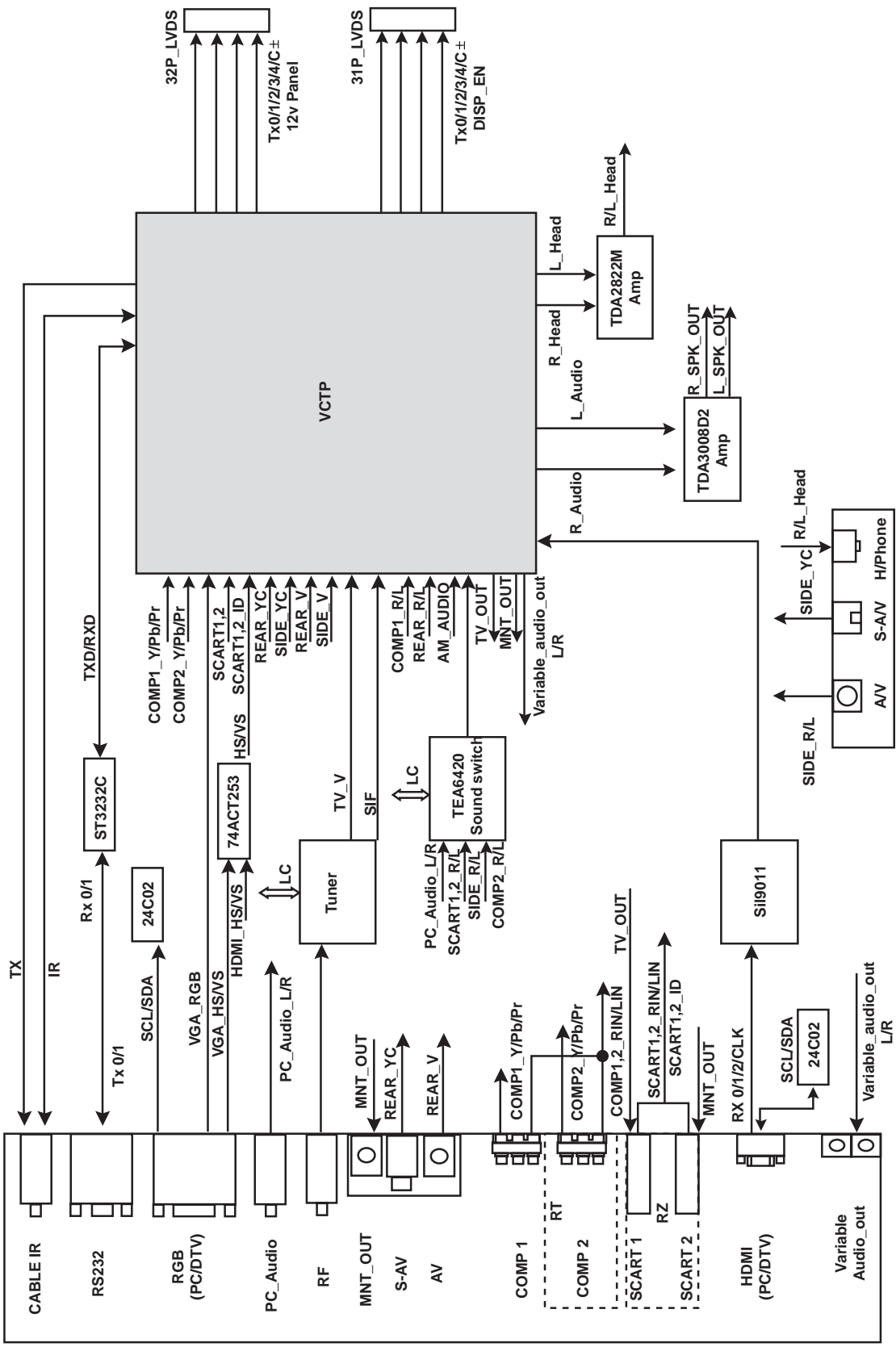

WIRING

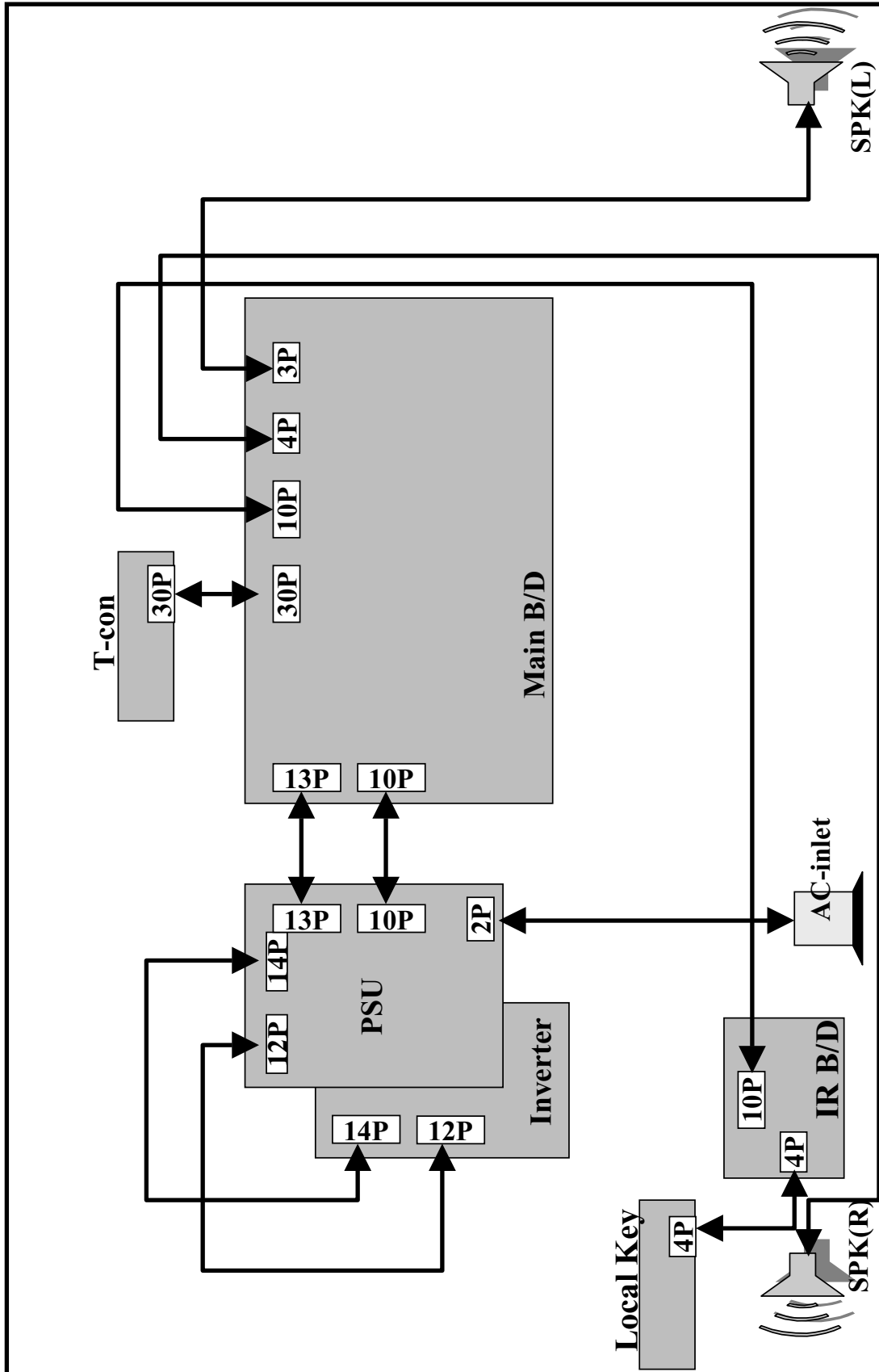

EXPLODED VIEW (26LC2R)

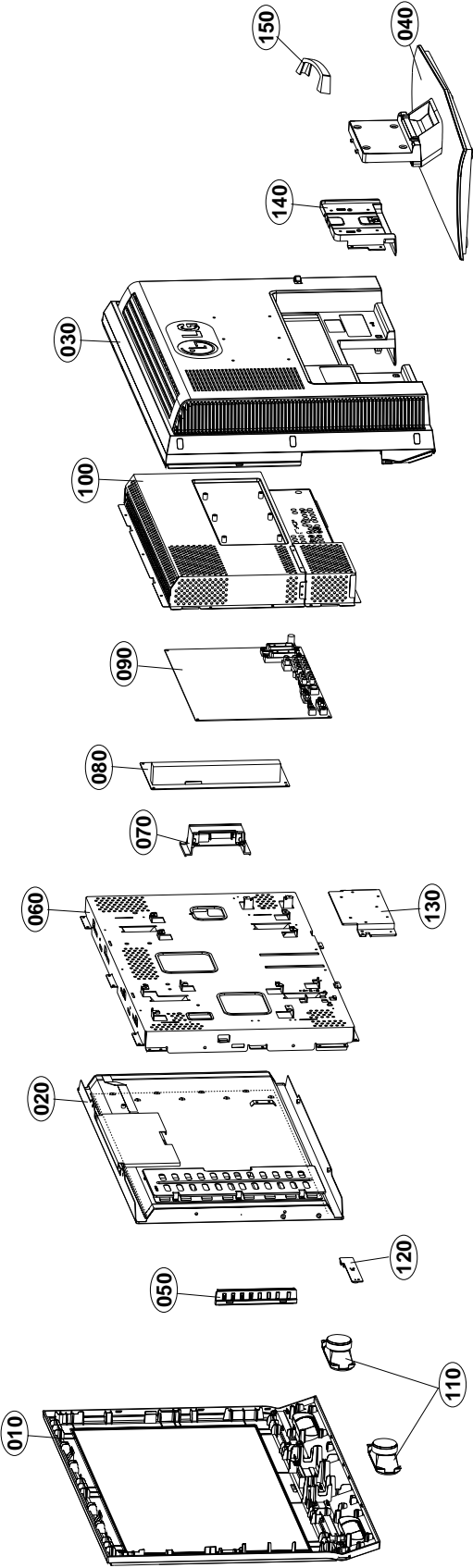

EXPLODED VIEW PARTS LIST(26LC2R)

No.	PART NO.	DESCRIPTION
010	⚠	30919E0027M Cover Assembly, 26LC2R-ZJ LP61C 26" HIPS 405AF(V0)-DMS
		30919E0027A Cover Assembly, 26LC2 BRAND 30909E0021 LG
		30919E0027N Cover Assembly, 26LC2R-ZJ LP61C 26" HIPS 405AF(V0),C/SKD-DMS
		30919E0027B Cover Assembly, 26LC2 BRAND 30909E0021 26LC2R -ZJ CSKD
020	⚠	6304FAU020B LCD,Module-TFT, T260XW02-V5 DRIVER 26.0INCH 1280X768 550CD COLOR - - - -
030	⚠	3809900134C Cover Assembly, 26LC2 NON LG BRAND 405AF-DMS
		3809900134A Cover Assembly, 26LC2 NON LG BRAND
		3809900134D Cover Assembly, 26LC2 NON LG BRAND 405AF(C/SKD)-DMS
		3809900134B Cover Assembly, 26LC2 NON LG BRAND CSKD
040	⚠	3043900029A Base Assembly, 26LC2R 3043900029A STAND TOTAL ASSY
		3043900026E Base Assembly, 32LC2R NONE STAND BOTTOM C/SKD WITH PRINTING
		3043900029B Base Assembly, 26LC2R 3043900029A STAND BODY ASSY C/SKD
050		68719ST934A PCB Assembly,Sub, SUB T.T LP61A 26LC2R ZJ LOCAL
060		49519S0021B Plate Assembly, FRAME 26LC2 BRAND(AUO MODULE)
		49519S0021D Plate Assembly, FRAME 26LC2 BRAND(AUO MODULE) CSKD
070		68719STA75A PCB Assembly,Sub, SUB T.T LP61C 26LC2R CJ(AUO) GUMI MFG
		EBR30397401 PCB Assembly,Sub, SUB PAKING LP61C 26LC2R TJ SIDE AV SKD
080	⚠	6709900016A Power Supply Assembly, FREE H3/E2 LCD MODEL LCD LG ELECTRONICS LB LC
090	⚠	33139L2017A Main Total Assembly, 26LC2R(AUO) BRAND LC61A -DMS
		33139L2017C Main Total Assembly, 26LC2R(AUO) BRAND LC61C for China Language support
100		49519S0030B Plate Assembly, REAR SHIELD MAIN B (26LC2R)
		49519S0030D Plate Assembly, REAR SHIELD MAIN B (26LC2R-TJ) CSKD
110		6400GESF01A Speaker,Fullrange, C112K01K1450 FERRITE 15W 8OHM 93DB 170HZ 116X42X38.5mM LUG
120		EBR30373401 PCB Assembly,Sub, SUB T.T LP61A 32LC2R . Preamp+LED for DMS
		68719ST940A PCB Assembly,Sub, SUB T.T LP61A 32LC2R ZJ PREAMP+LED
130		4810900046A Bracket, MOLD HIPS COVER 26LC2 AB HIPS 407AF LG BRAND
140		4811900063A Bracket Assembly, COVER 26LC2R LP61A BRACKET ASSY
150		35509K0197A Cover, MOLD HIPS 32LC2 CABLE MANAGEMENT

EXPLODED VIEW(32LC2R)

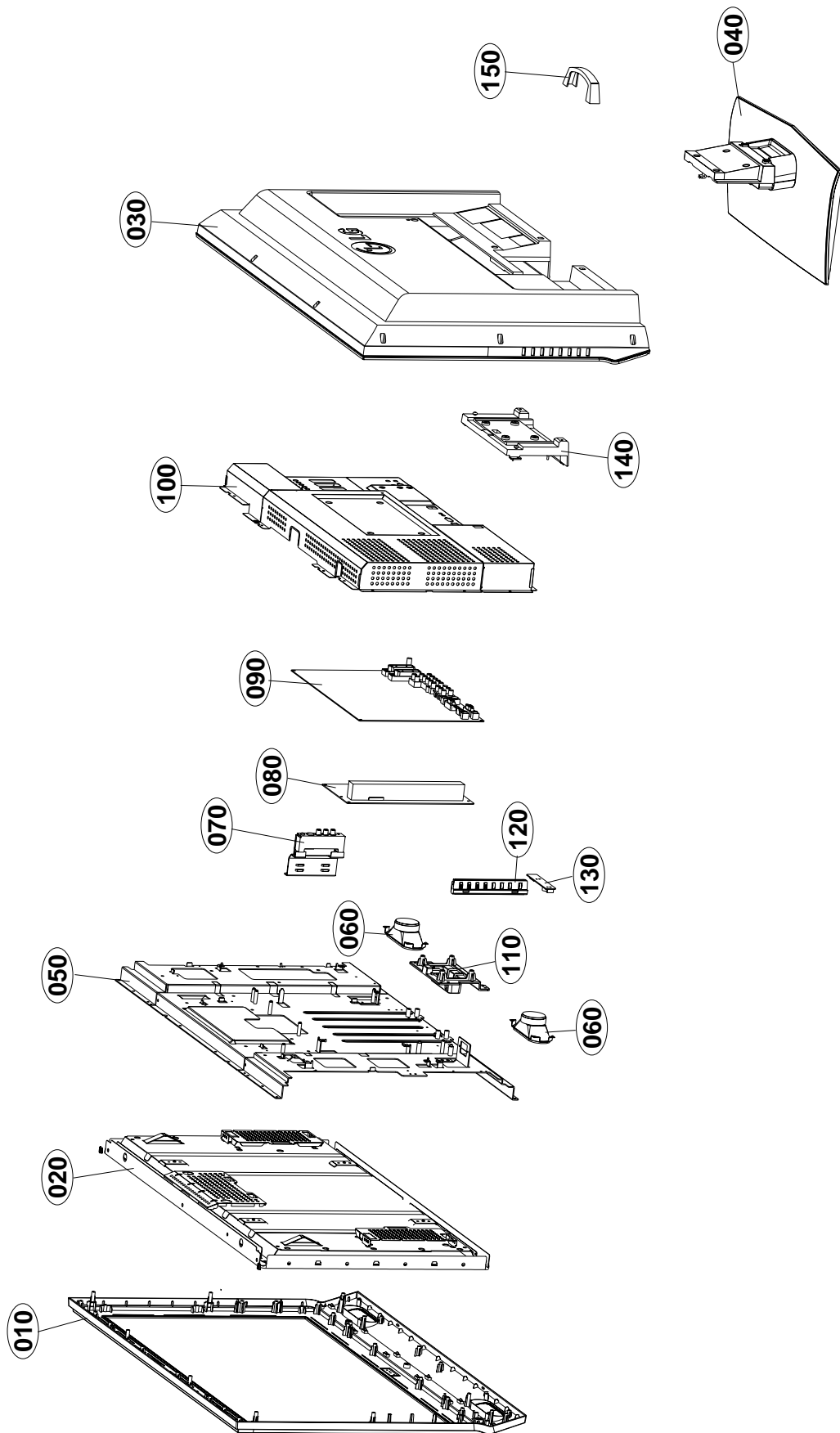

EXPLODED VIEW PARTS LIST(32LC2R)

No.	PART NO.	DESCRIPTION
010	⚠ 30919E0041X	Cover Assembly, 32LC2R-TJ LP61C 32" FOR AUSTRALIA MARKET
	⚠ 30919E0041A	Cover Assembly, 32LC2R-ZJ BRAND 30909E0019A HURRICANE3
	⚠ 30919E0041F	Cover Assembly, 32LC2R-ZJ BRAND 30909E0019A HURRICANE3 C/SKD
020	⚠ 6304FAU022A	LCD,Module-TFT, T315XW01-V5 XGA 31.5INCH 1366X768 500CD COLOR 72% 16/9 1200:1 SPREAD SPECTRUM
030	3809900159Q	Cover Assembly, 32LC2R-TJ LP61C 32" FOR AUSTRALIA MARKET
	3809900159K	Cover Assembly, 32LC2R-TJ NON HURRICANE3
	3809900159L	Cover Assembly, 32LC2R-TJ NON HURRICANE3 C/SKD
040	⚠ 3043900026B	Base Assembly, 32LC2D-ND NONE WITH PRINTING
	3043900026C	Base Assembly, 32LC2D NONE STAND NECK C/SKD
	⚠ 3043900026E	Base Assembly, 32LC2R NONE STAND BOTTOM C/SKD WITH PRINTING
050	49519S0031F	Plate Assembly, FRAME H3 32LC2R-ZJ AUO
	49519S0031J	Plate Assembly, FRAME H3 32LC2R-ZJ AUO C/SKD
060	6400GESF01A	Speaker,Fullrange, C112K01K1450 FERRITE 15W 8OHM 93DB 170HZ 116X42X38.5mM LUG
070	68719ST892A	PCB Assembly,Sub, SUB T.T LP61A 32LC2R Z SIDE AV
	EBR30375201	PCB Assembly,Sub, SUB T.T LP61A 32LC2R . SIDE AV for DMS
080	6709900016C	SMPS,AC/DC, LGLP2637HEP 90.0VTO264.0V 215W 47TO63HZ UL/CSA/SEMKO YY / AT / H&E
	or 6709900016A	Power Supply Assembly, FREE H3/E2 LCD MODEL LCD LG ELECTRONICS LB LC
090	33139L3028A	Main Total Assembly, 32LC2R(AUO) BRAND LC61A - Non EU
	33139L3028E	Main Total Assembly, 32LC2R(AUO) AUSTRALIA BRAND LP61C
	33139L3028B	Main Total Assembly, 32LC2R(AUO) BRAND LC61A- Southeast Asia(Language China, English)
100	49509K0157F	Plate, SHIELD, 32LC2R-TJ H3-M
110	49509K0195A	Plate, CASTING AL FRAME SUPPORT 32LC2
120	68719ST934A	PCB Assembly,Sub, SUB T.T LP61A 26LC2R ZJ LOCAL
	EBR30372601	PCB Assembly,Sub, SUB T.T LP61A 32LC2R . Local for DMS
130	68719ST940A	PCB Assembly,Sub, SUB T.T LP61A 32LC2R ZJ PREAMP+LED
	EBR30373401	PCB Assembly,Sub, SUB T.T LP61A 32LC2R . Preamp+LED for DMS
140	35509K0199A	Cover, MOLD HIPS 32LC2 REAR STAND SUPPORTER
150	35509K0197A	Cover, MOLD HIPS 32LC2 CABLE MANAGEMENT

REPLACEMENT PARTS LIST

For Capacitor & Resistors, the characters at 2nd and 3rd digit in the P/No. means as follows;

CC, CX, CK, CN, CH : Ceramic
CQ : Polyester
CE : Electrolytic
CF : Fixed Film

RD : Carbon Film
RS : Metal Oxide Film
RN : Metal Film
RH : CHIP, Metal Glazed(Chip)
RR : Drawing

DATE: 2006. 03. 25.				
*S	*AL	LOC. NO.	PART NO.	DESCRIPTION / SPECIFICATION
MAIN BOARD				
CAPACITOR				
			C1001	OCE107WF6DC MVK6.3TP16VC100M 100uF 20%
			C1003	OCE107WF6DC MVK6.3TP16VC100M 100uF 20%
			C1007	OCE107WF6DC MVK6.3TP16VC100M 100uF 20%
			C1009	OCE107WF6DC MVK6.3TP16VC100M 100uF 20%
			C1010	OCE107WF6DC MVK6.3TP16VC100M 100uF 20%
			C1017	OCE477WF6DC MVK10TP16VC470M 470uF 20% 1
			C1018	OCE227WF6DC MVK8.0TP16VC220M 220uF 20%
			C1019	OCE477WF6DC MVK10TP16VC470M 470uF 20% 1
			C1021	OCE227WF6DC MVK8.0TP16VC220M 220uF 20%
			C1031	OCE107WF6DC MVK6.3TP16VC100M 100uF 20%
			C1038	OCE477WF6DC MVK10TP16VC470M 470uF 20% 1
			C1040	OCE476WF6DC MVK6.3TP16VC47M 47uF 20% 16
			C1046	OCE477WF6DC MVK10TP16VC470M 470uF 20% 1
			C1047	OCE107WF6DC MVK6.3TP16VC100M 100uF 20%
			C1048	OCE107WF6DC MVK6.3TP16VC100M 100uF 20%
			C1064	OCE107WF6DC MVK6.3TP16VC100M 100uF 20%
			C1065	OCE107WF6DC MVK6.3TP16VC100M 100uF 20%
			C1066	OCE107WF6DC MVK6.3TP16VC100M 100uF 20%
			C1068	OCE107WF6DC MVK6.3TP16VC100M 100uF 20%
			C1070	OCE476WF6DC MVK6.3TP16VC47M 47uF 20% 16
			C1071	OCE227WF6DC MVK8.0TP16VC220M 220uF 20%
			C1074	OCE107WF6DC MVK6.3TP16VC100M 100uF 20%
			C160	OCE227WF6DC MVK8.0TP16VC220M 220uF 20%
			C161	OCE227WF6DC MVK8.0TP16VC220M 220uF 20%
			C170	OCE106WH6DC MVK5.0TP25VC10M 10uF 20% 25
			C171	OCE106WH6DC MVK5.0TP25VC10M 10uF 20% 25
			C313	OCE476WF6DC MVK6.3TP16VC47M 47uF 20% 16
			C340	OCE107WF6DC MVK6.3TP16VC100M 100uF 20%
			C343	OCE476WF6DC MVK6.3TP16VC47M 47uF 20% 16
			C345	OCE226WF6DC MVK5.0TP16VC22M 22uF 20% 16
			C346	OCE476WF6DC MVK6.3TP16VC47M 47uF 20% 16
			C401	OCE476WF6DC MVK6.3TP16VC47M 47uF 20% 16
			C500	OCE477WF6DC MVK10TP16VC470M 470uF 20% 1
			C502	OCE477WF6DC MVK10TP16VC470M 470uF 20% 1
			C503	OCE475SK6DC VMV475M050S0ANB010 4.7uF 20
			C513	OCE477WF6DC MVK10TP16VC470M 470uF 20% 1
			C519	OCE107WF6DC MVK6.3TP16VC100M 100uF 20%
			C523	OCE476WK6DC MVK8.0TP50VC47M 47uF 20% 50
			C525	OCE107WF6DC MVK6.3TP16VC100M 100uF 20%
			C629	OCE475WJ6DC MVK4.0TP35VC4.7M 4.7uF 20%
			C637	OCE335WK6D8 MVK4.0TP50VC3.3M 3.3uF 20%
			C657	OCE226WF6DC MVK5.0TP16VC22M 22uF 20% 16
			C658	OCE226WF6DC MVK5.0TP16VC22M 22uF 20% 16
			C659	OCE226WF6DC MVK5.0TP16VC22M 22uF 20% 16
			C660	OCE226WF6DC MVK5.0TP16VC22M 22uF 20% 16
			C676	OCE226WF6DC MVK5.0TP16VC22M 22uF 20% 16
			C677	OCE226WF6DC MVK5.0TP16VC22M 22uF 20% 16
			C682	OCE226WF6DC MVK5.0TP16VC22M 22uF 20% 16
			C683	OCE226WF6DC MVK5.0TP16VC22M 22uF 20% 16
			C684	OCE226WF6DC MVK5.0TP16VC22M 22uF 20% 16
			C685	OCE226WF6DC MVK5.0TP16VC22M 22uF 20% 16
			C686	OCE226WF6DC MVK5.0TP16VC22M 22uF 20% 16

DATE: 2006. 03. 25.				
*S	*AL	LOC. NO.	PART NO.	DESCRIPTION / SPECIFICATION
			C719	OCE226WF6DC MVK5.0TP16VC22M 22uF 20% 16
			C727	OCE226WF6DC MVK5.0TP16VC22M 22uF 20% 16
			C733	OCE226WF6DC MVK5.0TP16VC22M 22uF 20% 16
			C743	OCE226WF6DC MVK5.0TP16VC22M 22uF 20% 16
			C744	OCE226WF6DC MVK5.0TP16VC22M 22uF 20% 16
			C756	OCE476WF6DC MVK6.3TP16VC47M 47uF 20% 16
			C757	OCE106WH6DC MVK5.0TP25VC10M 10uF 20% 25
			C758	OCE476WF6DC MVK6.3TP16VC47M 47uF 20% 16
			C759	OCE476WF6DC MVK6.3TP16VC47M 47uF 20% 16
			C760	OCE476WF6DC MVK6.3TP16VC47M 47uF 20% 16
			C761	OCE476WF6DC MVK6.3TP16VC47M 47uF 20% 16
			C762	OCE476WF6DC MVK6.3TP16VC47M 47uF 20% 16
			C763	OCE476WF6DC MVK6.3TP16VC47M 47uF 20% 16
			C800	OCE107WF6DC MVK6.3TP16VC100M 100uF 20%
			C802	OCE226WF6DC MVK5.0TP16VC22M 22uF 20% 16
			C828	OCE107WK6DC MVK10TP50VC100M 100uF 20% 5
			C860	OCE227WJ6DC MVK10TP35VC220M 220uF 20% 3
			C861	OCE227WJ6DC MVK10TP35VC220M 220uF 20% 3
			C863	OCE106WH6DC MVK5.0TP25VC10M 10uF 20% 25
			C868	OCE475WJ6DC MVK4.0TP35VC4.7M 4.7uF 20%
			C869	OCE475WJ6DC MVK4.0TP35VC4.7M 4.7uF 20%
			C912	OCE476WF6DC MVK6.3TP16VC47M 47uF 20% 16
			C917	OCE477WF6DC MVK10TP16VC470M 470uF 20% 1
			C922	OCE476WF6DC MVK6.3TP16VC47M 47uF 20% 16
			C931	OCE476WF6DC MVK6.3TP16VC47M 47uF 20% 16
			C932	OCE476WF6DC MVK6.3TP16VC47M 47uF 20% 16
			C933	OCE477WF6DC MVK10TP16VC470M 470uF 20% 1
			C935	OCE477WF6DC MVK10TP16VC470M 470uF 20% 1
			C939	OCE477WF6DC MVK10TP16VC470M 470uF 20% 1
			C946	OCE107WF6DC MVK6.3TP16VC100M 100uF 20%
			C947	OCE107WF6DC MVK6.3TP16VC100M 100uF 20%
			C948	OCE107WF6DC MVK6.3TP16VC100M 100uF 20%
			C951	OCE477WF6DC MVK10TP16VC470M 470uF 20% 1
			C953	OCE477WF6DC MVK10TP16VC470M 470uF 20% 1
			C955	OCE107WF6DC MVK6.3TP16VC100M 100uF 20%
			C978	OCE476WF6DC MVK6.3TP16VC47M 47uF 20% 16
			C979	OCE476WF6DC MVK6.3TP16VC47M 47uF 20% 16
			C980	OCE476WF6DC MVK6.3TP16VC47M 47uF 20% 16
			C981	OCE476WF6DC MVK6.3TP16VC47M 47uF 20% 16
			C982	OCE476WF6DC MVK6.3TP16VC47M 47uF 20% 16
			C983	OCE476WF6DC MVK6.3TP16VC47M 47uF 20% 16
			C984	OCE476WF6DC MVK6.3TP16VC47M 47uF 20% 16
			C985	OCE476WF6DC MVK6.3TP16VC47M 47uF 20% 16
			C986	OCE476WF6DC MVK6.3TP16VC47M 47uF 20% 16
			C988	OCE106WH6DC MVK5.0TP25VC10M 10uF 20% 25
			C1016	OCE477EJ618 KMG5.0TP35VB470M 470uF 20%
			C1020	OCE477EJ618 KMG5.0TP35VB470M 470uF 20%
			C1000	OCK104CK56A 0603B104K500CT 100nF 10% 50
			C1002	OCK104CK56A 0603B104K500CT 100nF 10% 50
			C1004	OCK104CK56A 0603B104K500CT 100nF 10% 50
			C1005	OCK104CK56A 0603B104K500CT 100nF 10% 50
			C1006	OCK103CK56A 0603B103K500CT 10nF 10% 50V
			C1008	OCK103CK56A 0603B103K500CT 10nF 10% 50V
			C1011	OCK103CK56A 0603B103K500CT 10nF 10% 50V

DATE: 2006. 03. 25.				
*S	*AL	LOC. NO.	PART NO.	DESCRIPTION / SPECIFICATION
		C1012	0CK104CK56A	0603B104K500CT 100nF 10% 50
		C1013	0CK104CK56A	0603B104K500CT 100nF 10% 50
		C1014	0CK104CK56A	0603B104K500CT 100nF 10% 50
		C1015	0CK104CK56A	0603B104K500CT 100nF 10% 50
		C1022	0CK104CK56A	0603B104K500CT 100nF 10% 50
		C1023	0CK104CK56A	0603B104K500CT 100nF 10% 50
		C1024	0CK104CK56A	0603B104K500CT 100nF 10% 50
		C1025	0CK104CK56A	0603B104K500CT 100nF 10% 50
		C1026	0CK103CK56A	0603B103K500CT 10nF 10% 50V
		C1027	0CK104CK56A	0603B104K500CT 100nF 10% 50
		C1029	0CK103CK56A	0603B103K500CT 10nF 10% 50V
		C1036	0CK104CK56A	0603B104K500CT 100nF 10% 50
		C1037	0CK104CK56A	0603B104K500CT 100nF 10% 50
		C1039	0CK103CK56A	0603B103K500CT 10nF 10% 50V
		C1043	0CK104CK56A	0603B104K500CT 100nF 10% 50
		C1045	0CK104CK56A	0603B104K500CT 100nF 10% 50
		C1050	0CK104CK56A	0603B104K500CT 100nF 10% 50
		C1051	0CK104CK56A	0603B104K500CT 100nF 10% 50
		C1052	0CK104CK56A	0603B104K500CT 100nF 10% 50
		C1054	0CK104CK56A	0603B104K500CT 100nF 10% 50
		C1056	0CK103CK56A	0603B103K500CT 10nF 10% 50V
		C1057	0CK103CK56A	0603B103K500CT 10nF 10% 50V
		C1058	0CK103CK56A	0603B103K500CT 10nF 10% 50V
		C1061	0CK103CK56A	0603B103K500CT 10nF 10% 50V
		C1069	0CK104CK56A	0603B104K500CT 100nF 10% 50
		C1072	0CK104CK56A	0603B104K500CT 100nF 10% 50
		C1073	0CK103CK56A	0603B103K500CT 10nF 10% 50V
		C159	0CC102CK41A	C1608C0G1H102JT 1nF 5% 50V
		C162	0CC102CK41A	C1608C0G1H102JT 1nF 5% 50V
		C163	0CK103CK56A	0603B103K500CT 10nF 10% 50V
		C164	0CK103CK56A	0603B103K500CT 10nF 10% 50V
		C309	0CK103CK56A	0603B103K500CT 10nF 10% 50V
		C310	0CK103CK56A	0603B103K500CT 10nF 10% 50V
		C311	0CC470CK41A	C1608C0G1H470JT 47pF 5% 50V
		C312	0CK104CK56A	0603B104K500CT 100nF 10% 50
		C316	0CC120CK41A	C1608C0G1H120JT 12pF 5% 50V
		C317	0CC120CK41A	C1608C0G1H120JT 12pF 5% 50V
		C337	0CK104CK56A	0603B104K500CT 100nF 10% 50
		C338	0CK104CK56A	0603B104K500CT 100nF 10% 50
		C339	0CK104CK56A	0603B104K500CT 100nF 10% 50
		C350	0CK103CK56A	0603B103K500CT 10nF 10% 50V
		C351	0CK104CK56A	0603B104K500CT 100nF 10% 50
		C352	0CK104CK56A	0603B104K500CT 100nF 10% 50
		C400	0CK104CK56A	0603B104K500CT 100nF 10% 50
		C406	0CK104CK56A	0603B104K500CT 100nF 10% 50
		C407	0CK104CK56A	0603B104K500CT 100nF 10% 50
		C408	0CK104CK56A	0603B104K500CT 100nF 10% 50
		C409	0CK104CK56A	0603B104K500CT 100nF 10% 50
		C410	0CK102CK56A	0603B102K500CT 1nF 10% 50V
		C411	0CK102CK56A	0603B102K500CT 1nF 10% 50V
		C412	0CK104CK56A	0603B104K500CT 100nF 10% 50
		C413	0CK104CK56A	0603B104K500CT 100nF 10% 50
		C414	0CK104CK56A	0603B104K500CT 100nF 10% 50
		C415	0CK104CK56A	0603B104K500CT 100nF 10% 50
		C416	0CK104CK56A	0603B104K500CT 100nF 10% 50
		C417	0CK102CK56A	0603B102K500CT 1nF 10% 50V
		C419	0CK104CK56A	0603B104K500CT 100nF 10% 50
		C420	0CK102CK56A	0603B102K500CT 1nF 10% 50V
		C421	0CK104CK56A	0603B104K500CT 100nF 10% 50
		C424	0CK104CK56A	0603B104K500CT 100nF 10% 50
		C425	0CK104CK56A	0603B104K500CT 100nF 10% 50
		C426	0CK104CK56A	0603B104K500CT 100nF 10% 50

DATE: 2006. 03. 25.				
*S	*AL	LOC. NO.	PART NO.	DESCRIPTION / SPECIFICATION
		C506	0CK103CK56A	0603B103K500CT 10nF 10% 50V
		C507	0CK103CK56A	0603B103K500CT 10nF 10% 50V
		C508	0CC270CK41A	C1608C0G1H270JT 27pF 5% 50V
		C509	0CC270CK41A	C1608C0G1H270JT 27pF 5% 50V
		C511	0CK103CK56A	0603B103K500CT 10nF 10% 50V
		C512	0CC101CK41A	C1608C0G1H101JT 100pF 5% 50
		C514	0CK273CK56A	0603B273K500CT 27nF 10% 50V
		C515	0CK103CK56A	0603B103K500CT 10nF 10% 50V
		C516	0CK104CK56A	0603B104K500CT 100nF 10% 50
		C517	0CK273CK56A	0603B273K500CT 27nF 10% 50V
		C518	0CK104CK56A	0603B104K500CT 100nF 10% 50
		C520	0CK104CK56A	0603B104K500CT 100nF 10% 50
		C521	0CC271CK41A	C1608C0G1H271JT 270pF 5% 50
		C524	0CK104CK56A	0603B104K500CT 100nF 10% 50
		C638	0CK104CK56A	0603B104K500CT 100nF 10% 50
		C643	0CK332CK56A	C1608X7R1H332KT 3.3nF 10% 5
		C645	0CK332CK56A	C1608X7R1H332KT 3.3nF 10% 5
		C649	0CK104CK56A	0603B104K500CT 100nF 10% 50
		C652	0CC560CK41A	C1608C0G1H560JT 56pF 5% 50V
		C662	0CK225DK94A	CL21F225ZBFNNNE 2.2uF -20TO
		C663	0CK104CK56A	0603B104K500CT 100nF 10% 50
		C664	0CK104CK56A	0603B104K500CT 100nF 10% 50
		C665	0CK225DK94A	CL21F225ZBFNNNE 2.2uF -20TO
		C666	0CK225DD66A	LMK212JB225MG-T 2.2uF 20% 1
		C687	0CK104CK56A	0603B104K500CT 100nF 10% 50
		C693	0CK104CK56A	0603B104K500CT 100nF 10% 50
		C694	0CK104CK56A	0603B104K500CT 100nF 10% 50
		C695	0CK104CK56A	0603B104K500CT 100nF 10% 50
		C696	0CK104CK56A	0603B104K500CT 100nF 10% 50
		C697	0CK104CK56A	0603B104K500CT 100nF 10% 50
		C704	0CK104CK56A	0603B104K500CT 100nF 10% 50
		C705	0CK104CK56A	0603B104K500CT 100nF 10% 50
		C713	0CK104CK56A	0603B104K500CT 100nF 10% 50
		C721	0CK104CK56A	0603B104K500CT 100nF 10% 50
		C726	0CK104CK56A	0603B104K500CT 100nF 10% 50
		C729	0CK104CK56A	0603B104K500CT 100nF 10% 50
		C735	0CK104CK56A	0603B104K500CT 100nF 10% 50
		C739	0CK104CK56A	0603B104K500CT 100nF 10% 50
		C749	0CK104CK56A	0603B104K500CT 100nF 10% 50
		C750	0CK225DK94A	CL21F225ZBFNNNE 2.2uF -20TO
		C753	0CK104CK56A	0603B104K500CT 100nF 10% 50
		C764	0CK106EF56A	C3216X7R1C106KT 10uF 10% 16
		C765	0CK106EF56A	C3216X7R1C106KT 10uF 10% 16
		C766	0CK106EF56A	C3216X7R1C106KT 10uF 10% 16
		C801	0CK103CK56A	0603B103K500CT 10nF 10% 50V
		C816	0CK225DK94A	CL21F225ZBFNNNE 2.2uF -20TO
		C820	0CK225DK94A	CL21F225ZBFNNNE 2.2uF -20TO
		C827	0CC471CK41A	C1608C0G1H471JT 470pF 5% 50
		C829	0CC471CK41A	C1608C0G1H471JT 470pF 5% 50
		C830	0CK103CK56A	0603B103K500CT 10nF 10% 50V
		C836	0CK104CK56A	0603B104K500CT 100nF 10% 50
		C838	0CK104CK56A	0603B104K500CT 100nF 10% 50
		C839	0CK104CK56A	0603B104K500CT 100nF 10% 50
		C840	0CK102CK56A	0603B102K500CT 1nF 10% 50V
		C842	0CK102CK56A	0603B102K500CT 1nF 10% 50V
		C845	0CK474CH94A	0603F474Z250CT 470nF -20TO+
		C848	0CK104CK56A	0603B104K500CT 100nF 10% 50
		C849	0CK474CH94A	0603F474Z250CT 470nF -20TO+
		C850	0CK104CK56A	0603B104K500CT 100nF 10% 50
		C851	0CK105CF94A	0603F105Z160CT 1uF -20TO+80
		C853	0CK103CK56A	0603B103K500CT 10nF 10% 50V
		C856	0CK105CF94A	0603F105Z160CT 1uF -20TO+80

DATE: 2006. 03. 25.				
*S	*AL	LOC. NO.	PART NO.	DESCRIPTION / SPECIFICATION
		C859	0CK105CF94A	0603F105Z160CT 1uF -20TO+80
		C862	0CK105CF94A	0603F105Z160CT 1uF -20TO+80
		C866	0CK682CK51A	C1608Y5P1H682KT 6.8nF 10% 5
		C867	0CK682CK51A	C1608Y5P1H682KT 6.8nF 10% 5
		C906	0CK104CK56A	0603B104K500CT 100nF 10% 50
		C908	0CK474CH94A	0603F474Z250CT 470nF -20TO+
		C916	0CK104CK56A	0603B104K500CT 100nF 10% 50
		C919	0CK104CK56A	0603B104K500CT 100nF 10% 50
		C921	0CK103CK56A	0603B103K500CT 10nF 10% 50V
		C930	0CK104CK56A	0603B104K500CT 100nF 10% 50
		C934	0CK104CK56A	0603B104K500CT 100nF 10% 50
		C936	0CK104CK56A	0603B104K500CT 100nF 10% 50
		C937	0CK104CK56A	0603B104K500CT 100nF 10% 50
		C938	0CK104CK56A	0603B104K500CT 100nF 10% 50
		C941	0CK103CK56A	0603B103K500CT 10nF 10% 50V
		C942	0CK103CK56A	0603B103K500CT 10nF 10% 50V
		C943	0CK103CK56A	0603B103K500CT 10nF 10% 50V
		C945	0CK104CK56A	0603B104K500CT 100nF 10% 50
		C949	0CK103CK56A	0603B103K500CT 10nF 10% 50V
		C950	0CK104CK56A	0603B104K500CT 100nF 10% 50
		C957	0CK104CK56A	0603B104K500CT 100nF 10% 50
		C958	0CK104CK56A	0603B104K500CT 100nF 10% 50
		C959	0CK104CK56A	0603B104K500CT 100nF 10% 50
		C960	0CK104CK56A	0603B104K500CT 100nF 10% 50
		C961	0CK104CK56A	0603B104K500CT 100nF 10% 50
		C962	0CK104CK56A	0603B104K500CT 100nF 10% 50
		C963	0CK104CK56A	0603B104K500CT 100nF 10% 50
		C964	0CK104CK56A	0603B104K500CT 100nF 10% 50
		C965	0CK104CK56A	0603B104K500CT 100nF 10% 50
		C967	0CK103CK56A	0603B103K500CT 10nF 10% 50V
		C968	0CK103CK56A	0603B103K500CT 10nF 10% 50V
		C969	0CK103CK56A	0603B103K500CT 10nF 10% 50V
		C970	0CK103CK56A	0603B103K500CT 10nF 10% 50V
		C972	0CK103CK56A	0603B103K500CT 10nF 10% 50V
		C973	0CK103CK56A	0603B103K500CT 10nF 10% 50V
		C974	0CK103CK56A	0603B103K500CT 10nF 10% 50V
		C975	0CK103CK56A	0603B103K500CT 10nF 10% 50V
		C976	0CK103CK56A	0603B103K500CT 10nF 10% 50V
		C1059	0CK104CK56A	0603B104K500CT 100nF 10% 50
		C1063	0CK103CK56A	0603B103K500CT 10nF 10% 50V
		C172	0CK682CK51A	C1608Y5P1H682KT 6.8nF 10% 5
		C173	0CK682CK51A	C1608Y5P1H682KT 6.8nF 10% 5
		C174	0CK682CK51A	C1608Y5P1H682KT 6.8nF 10% 5
		C175	0CK682CK51A	C1608Y5P1H682KT 6.8nF 10% 5
		C332	0CK104CK56A	0603B104K500CT 100nF 10% 50
		C333	0CK104CK56A	0603B104K500CT 100nF 10% 50
		C334	0CK104CK56A	0603B104K500CT 100nF 10% 50
		C335	0CK104CK56A	0603B104K500CT 100nF 10% 50
		C336	0CK104CK56A	0603B104K500CT 100nF 10% 50
		C347	0CK104CF56A	0603B104K160CT 100nF 10% 16
		C429	0CK822CK46A	0603B822J500CT 8.2nF 5% 50V
		C430	0CK823CF56A	0603B823K160CT 82nF 10% 16V
		C522	0CC271CK41A	C1608C0G1H271JT 270pF 5% 50
		C609	0CK104CK56A	0603B104K500CT 100nF 10% 50
		C610	0CK104CK56A	0603B104K500CT 100nF 10% 50
		C611	0CK104CK56A	0603B104K500CT 100nF 10% 50
		C612	0CK104CK56A	0603B104K500CT 100nF 10% 50
		C613	0CK104CK56A	0603B104K500CT 100nF 10% 50
		C614	0CK104CK56A	0603B104K500CT 100nF 10% 50
		C615	0CK104CK56A	0603B104K500CT 100nF 10% 50
		C616	0CK104CK56A	0603B104K500CT 100nF 10% 50
		C617	0CK104CK56A	0603B104K500CT 100nF 10% 50

DATE: 2006. 03. 25.				
*S	*AL	LOC. NO.	PART NO.	DESCRIPTION / SPECIFICATION
		C618	0CK104CK56A	0603B104K500CT 100nF 10% 50
		C619	0CK104CK56A	0603B104K500CT 100nF 10% 50
		C620	0CK104CK56A	0603B104K500CT 100nF 10% 50
		C621	0CK104CK56A	0603B104K500CT 100nF 10% 50
		C622	0CK104CK56A	0603B104K500CT 100nF 10% 50
		C623	0CK104CK56A	0603B104K500CT 100nF 10% 50
		C624	0CK104CK56A	0603B104K500CT 100nF 10% 50
		C625	0CK104CK56A	0603B104K500CT 100nF 10% 50
		C626	0CK103CK56A	0603B103K500CT 10nF 10% 50V
		C627	0CK474CH94A	0603F474Z250CT 470nF -20TO+
		C628	0CK474CH94A	0603F474Z250CT 470nF -20TO+
		C630	0CK474CH94A	0603F474Z250CT 470nF -20TO+
		C631	0CK474CH94A	0603F474Z250CT 470nF -20TO+
		C632	0CK474CH94A	0603F474Z250CT 470nF -20TO+
		C633	0CK103CK56A	0603B103K500CT 10nF 10% 50V
		C634	0CK474CH94A	0603F474Z250CT 470nF -20TO+
		C635	0CK474CH94A	0603F474Z250CT 470nF -20TO+
		C636	0CK474CH94A	0603F474Z250CT 470nF -20TO+
		C647	0CK332CK56A	C1608X7R1H332KT 3.3nF 10% 5
		C648	0CK332CK56A	C1608X7R1H332KT 3.3nF 10% 5
		C650	0CK682CK51A	C1608Y5P1H682KT 6.8nF 10% 5
		C651	0CC560CK41A	C1608C0G1H560JT 56pF 5% 50V
		C653	0CK682CK51A	C1608Y5P1H682KT 6.8nF 10% 5
		C654	0CK103CK56A	0603B103K500CT 10nF 10% 50V
		C655	0CC220CK41A	C1608C0G1H220JT 22pF 5% 50V
		C661	0CK104CK56A	0603B104K500CT 100nF 10% 50
		C673	0CC220CK41A	C1608C0G1H220JT 22pF 5% 50V
		C674	0CC220CK41A	C1608C0G1H220JT 22pF 5% 50V
		C688	0CK104CK56A	0603B104K500CT 100nF 10% 50
		C803	0CK105CF94A	0603F105Z160CT 1uF -20TO+80
		C804	0CK105CF94A	0603F105Z160CT 1uF -20TO+80
		C806	0CK105CF94A	0603F105Z160CT 1uF -20TO+80
		C807	0CK105CF94A	0603F105Z160CT 1uF -20TO+80
		C821	0CK475EF67A	C3216X5R1C475MT 4.7uF 20% 1
		C822	0CK475EF67A	C3216X5R1C475MT 4.7uF 20% 1
		C823	0CK475EF67A	C3216X5R1C475MT 4.7uF 20% 1
		C824	0CK475EF67A	C3216X5R1C475MT 4.7uF 20% 1
		C825	0CK475EF67A	C3216X5R1C475MT 4.7uF 20% 1
		C831	0CK475EF67A	C3216X5R1C475MT 4.7uF 20% 1
		C832	0CK475EF67A	C3216X5R1C475MT 4.7uF 20% 1
		C833	0CK475EF67A	C3216X5R1C475MT 4.7uF 20% 1
		C834	0CK475EF67A	C3216X5R1C475MT 4.7uF 20% 1
		C835	0CK475EF67A	C3216X5R1C475MT 4.7uF 20% 1
		C854	0CK224CF56A	0603B224K160CT 220nF 10% 16
		C855	0CK224CF56A	0603B224K160CT 220nF 10% 16
		C857	0CK105CF94A	0603F105Z160CT 1uF -20TO+80
		C858	0CK105CF94A	0603F105Z160CT 1uF -20TO+80
		C864	0CK224CF56A	0603B224K160CT 220nF 10% 16
		C865	0CK224CF56A	0603B224K160CT 220nF 10% 16
		C915	0CK474CH94A	0603F474Z250CT 470nF -20TO+
		C926	0CK104CK56A	0603B104K500CT 100nF 10% 50
		C927	0CK104CK56A	0603B104K500CT 100nF 10% 50
		C928	0CK103CK56A	0603B103K500CT 10nF 10% 50V
		C929	0CK103CK56A	0603B103K500CT 10nF 10% 50V
		C989	0CK103CK56A	0603B103K500CT 10nF 10% 50V
DIODEs				
		D800	0DD184009AA	KDS184 KDS184 TP KEC - 85V
		D801	0DD184009AA	KDS184 KDS184 TP KEC - 85V
		D400	0DD184009AA	KDS184 KDS184 TP KEC - 85V
		D700	0DD184009AA	KDS184 KDS184 TP KEC - 85V

DATE: 2006. 03. 25.				
*S	*AL	LOC. NO.	PART NO.	DESCRIPTION / SPECIFICATION
		D905	0DD200009AF	RU2M 400V 1.2V 10UA 20A 400
		D906	0DD200009AF	RU2M 400V 1.2V 10UA 20A 400
		D907	0DD200009AF	RU2M 400V 1.2V 10UA 20A 400
		D1001	0DS226009AA	KDS226 1.2V 85V 300MA 2A 4N
		D1002	0DS226009AA	KDS226 1.2V 85V 300MA 2A 4N
		D1003	0DS226009AA	KDS226 1.2V 85V 300MA 2A 4N
		D116	0DS226009AA	KDS226 1.2V 85V 300MA 2A 4N
		D117	0DS226009AA	KDS226 1.2V 85V 300MA 2A 4N
		D118	0DS226009AA	KDS226 1.2V 85V 300MA 2A 4N
		D119	0DS226009AA	KDS226 1.2V 85V 300MA 2A 4N
		D120	0DS226009AA	KDS226 1.2V 85V 300MA 2A 4N
		D121	0DS226009AA	KDS226 1.2V 85V 300MA 2A 4N
		D124	0DS226009AA	KDS226 1.2V 85V 300MA 2A 4N
		D125	0DS226009AA	KDS226 1.2V 85V 300MA 2A 4N
		D126	0DS226009AA	KDS226 1.2V 85V 300MA 2A 4N
		D127	0DS226009AA	KDS226 1.2V 85V 300MA 2A 4N
		D128	0DS226009AA	KDS226 1.2V 85V 300MA 2A 4N
		D900	0DS226009AA	KDS226 1.2V 85V 300MA 2A 4N
		D902	0DS226009AA	KDS226 1.2V 85V 300MA 2A 4N
		D903	0DS226009AA	KDS226 1.2V 85V 300MA 2A 4N
		D500	0DS113379BA	1S133 1200MV 90V 400MA 600
		D300	0DS226009AA	KDS226 1.2V 85V 300MA 2A 4N
		D302	0DS226009AA	KDS226 1.2V 85V 300MA 2A 4N
		D303	0DS226009AA	KDS226 1.2V 85V 300MA 2A 4N
		ZD300	0DR050008AA	SD05.TC - 6V 14.5V 24A 350W
		ZD312	0DR050008AA	SD05.TC - 6V 14.5V 24A 350W
		ZD301	0DR050008AA	SD05.TC - 6V 14.5V 24A 350W
		ZD303	0DR050008AA	SD05.TC - 6V 14.5V 24A 350W
		ZD304	0DR050008AA	SD05.TC - 6V 14.5V 24A 350W
		ZD305	0DR050008AA	SD05.TC - 6V 14.5V 24A 350W
		ZD308	0DR050008AA	SD05.TC - 6V 14.5V 24A 350W
		ZD1000	0DZKE00048A	KDZ8.2V 8.2V 7.7TO8.7V 20OH
IC				
		IC303	0ISTL00031A	MC74HC4066ADR2G MC74HC4066A
		IC801	0IPRP00700A	TPA3100D2PHPR 10TO26V - . 2
		IC800	0IPRP00665A	TEA6420D 8TO10.2V 8mA - SO
		IC301	0IPH741400E	74HC14D 2TO6V 0.002mA SCHMI
		IC602	0IFA742530B	74ACT253SC 4.5TO5.5V 0.004m
		IC802	0IPRP00743A	MAD4868A 3TO5.25V - - PQFP
		IC300	0ICS240213A	CAT24WC02J-TE13 2KBIT 256X8
		IC400	0IMMRAL014C	AT24C02N-10SU-2.7 2KBIT 256
		IC603	0IMMRAL025A	AT24C32AN-10SI-2.7 32KBIT 4
		IC1001	0IPMGKE030A	KIA78R05F 6TO12V 5V 8W DPAK
		IC1002	0IPMG00027A	SC156515M-1.8TR 2.2TO5.5V 1
		IC900	0IMCRRH001A	BA033FP-E2 4.3TO25V 3.3V 1W
		IC902	0IPMG00027A	SC156515M-1.8TR 2.2TO5.5V 1
		IC903	0IMCRRH001A	BA033FP-E2 4.3TO25V 3.3V 1W
		IC601	0IPRP00689A	VCT6973G-FA-B2-000 0.3TO9.0
		IC401	0IPRP00701A	"AD9381KSTZ 3.15TO3.47,1.7TO"
		IC302	0IPRP00009A	ICL3232CBNZ 3.0TO5.5 - SSOP
		IC600	0IFA752700A	KA75270Z 2.55TO2.85V - 200M
		IC1003	0IMCRFA010A	KA7809R 11.5TO24V 9V 150W D
		IC500	0IPMGON013B	MC34063ADR2G 3TO40V 40V 625
COIL & CORE & INDUCTOR				
		L1004	6140VB0004B	LN-15A1 26uH - - 12X9MM LEA
		L910	6140VB0004B	LN-15A1 26uH - - 12X9MM LEA
		L1000	6210TCE001G	HH-1M3216-501JT 500OHM 3.2X
		L1001	6210TCE001G	HH-1M3216-501JT 500OHM 3.2X

DATE: 2006. 03. 25.				
*S	*AL	LOC. NO.	PART NO.	DESCRIPTION / SPECIFICATION
		L1002	6210TCE001G	HH-1M3216-501JT 500OHM 3.2X
		L1007	6210TCE001G	HH-1M3216-501JT 500OHM 3.2X
		L1008	6210TCE001G	HH-1M3216-501JT 500OHM 3.2X
		L1010	6210TCE001G	HH-1M3216-501JT 500OHM 3.2X
		L1011	6210TCE001G	HH-1M3216-501JT 500OHM 3.2X
		L1012	6210TCE001G	HH-1M3216-501JT 500OHM 3.2X
		L1015	6210TCE001G	HH-1M3216-501JT 500OHM 3.2X
		L1017	6210TCE001G	HH-1M3216-501JT 500OHM 3.2X
		L1018	6210TCE001G	HH-1M3216-501JT 500OHM 3.2X
		L112	6200J00005F	HB-1M1608-102JT 1000OHM 1.6
		L113	6200J00005F	HB-1M1608-102JT 1000OHM 1.6
		L114	6200J00005F	HB-1M1608-102JT 1000OHM 1.6
		L115	6200J00005F	HB-1M1608-102JT 1000OHM 1.6
		L300	6200JB8010L	MLB-201209-1000L-N2 1000OHM
		L301	6200JB8010L	MLB-201209-1000L-N2 1000OHM
		L303	6210TCE001G	HH-1M3216-501JT 500OHM 3.2X
		L305	6210TCE001G	HH-1M3216-501JT 500OHM 3.2X
		L401	6210TCE001G	HH-1M3216-501JT 500OHM 3.2X
		L402	6210TCE001G	HH-1M3216-501JT 500OHM 3.2X
		L500	6210TCE001G	HH-1M3216-501JT 500OHM 3.2X
		L501	6210TCE001G	HH-1M3216-501JT 500OHM 3.2X
		L502	6210TCE001G	HH-1M3216-501JT 500OHM 3.2X
		L806	6210TCE001G	HH-1M3216-501JT 500OHM 3.2X
		L904	6210TCE001G	HH-1M3216-501JT 500OHM 3.2X
		L913	6210TCE001G	HH-1M3216-501JT 500OHM 3.2X
		L914	6210TCE001G	HH-1M3216-501JT 500OHM 3.2X
		L915	6210TCE001G	HH-1M3216-501JT 500OHM 3.2X
		L916	6210TCE001G	HH-1M3216-501JT 500OHM 3.2X
		L917	6210TCE001G	HH-1M3216-501JT 500OHM 3.2X
		L918	6210TCE001G	HH-1M3216-501JT 500OHM 3.2X
		L919	6210TCE001G	HH-1M3216-501JT 500OHM 3.2X
		L920	6210TCE001G	HH-1M3216-501JT 500OHM 3.2X
		L921	6210TCE001G	HH-1M3216-501JT 500OHM 3.2X
		L923	6210TCE001P	HB-1S2012-121JT 120OHM 2X1.
		AR400	6210TCE002B	HB-4M3216-121JT 120OHM 3.2X
		AR401	6210TCE002B	HB-4M3216-121JT 120OHM 3.2X
		AR402	6210TCE002B	HB-4M3216-121JT 120OHM 3.2X
		AR403	6210TCE002B	HB-4M3216-121JT 120OHM 3.2X
		AR404	6210TCE002B	HB-4M3216-121JT 120OHM 3.2X
		AR405	6210TCE002B	HB-4M3216-121JT 120OHM 3.2X
		AR600	6210TCE002B	HB-4M3216-121JT 120OHM 3.2X
		AR601	6210TCE002B	HB-4M3216-121JT 120OHM 3.2X
		AR602	6210TCE002B	HB-4M3216-121JT 120OHM 3.2X
		L1016	6210TCE001G	HH-1M3216-501JT 500OHM 3.2X
		L302	6210TCE001G	HH-1M3216-501JT 500OHM 3.2X
		L304	6210TCE001E	HB-1M2012-800JT 800OHM 2X1.2
		L306	6210TCE001P	HB-1S2012-121JT 120OHM 2X1.
		L307	6210TCE001P	HB-1S2012-121JT 120OHM 2X1.
		L308	6210TCE001P	HB-1S2012-121JT 120OHM 2X1.
		L309	6210TCE001P	HB-1S2012-121JT 120OHM 2X1.
		L310	6210TCE001P	HB-1S2012-121JT 120OHM 2X1.
		L400	6210TCE001G	HH-1M3216-501JT 500OHM 3.2X
		L813	6210TCE001G	HH-1M3216-501JT 500OHM 3.2X
		L814	6210TCE001G	HH-1M3216-501JT 500OHM 3.2X
		L815	6210TCE001P	HB-1S2012-121JT 120OHM 2X1.
		L816	6210TCE001P	HB-1S2012-121JT 120OHM 2X1.
		L817	6210TCE001P	HB-1S2012-121JT 120OHM 2X1.
		L818	6210TCE001P	HB-1S2012-121JT 120OHM 2X1.
		L819	6210TCE001G	HH-1M3216-501JT 500OHM 3.2X
		L820	6210TCE001G	HH-1M3216-501JT 500OHM 3.2X
		L905	6210TCE001G	HH-1M3216-501JT 500OHM 3.2X
		L906	6210TCE001G	HH-1M3216-501JT 500OHM 3.2X

DATE: 2006. 03. 25.				
*S	*AL	LOC. NO.	PART NO.	DESCRIPTION / SPECIFICATION
		L924	6210TCE001G	HH-1M3216-501JT 500OHM 3.2X
		L118	0LCML00020G	MLI-201209-3R3K 3.3UH 10% -
		L119	0LCML00020G	MLI-201209-3R3K 3.3UH 10% -
		L120	0LCML00020G	MLI-201209-3R3K 3.3UH 10% -
		L121	0LCML00020G	MLI-201209-3R3K 3.3UH 10% -
		L804	0LCML00020C	MLI-201212-100K 10UH 10% -
		L805	0LCML00020C	MLI-201212-100K 10UH 10% -
		L503	0LCML00020G	MLI-201209-3R3K 3.3UH 10% -
		L504	0LC6461201A	D75C-646CY-121M=P3 120UH 20
		L801	6140VR0008A	SLF12575T-330M3R2 33UH 20%
		L802	6140VR0008A	SLF12575T-330M3R2 33UH 20%
		L808	6140VR0008A	SLF12575T-330M3R2 33UH 20%
		L809	6140VR0008A	SLF12575T-330M3R2 33UH 20%
FET & TRANSISTOR				
		Q401	0TR830009BA	BSS83 N-CHANNEL MOSFET 10V
		Q402	0TR830009BA	BSS83 N-CHANNEL MOSFET 10V
		Q508	0TR830009BA	BSS83 N-CHANNEL MOSFET 10V
		Q509	0TR830009BA	BSS83 N-CHANNEL MOSFET 10V
		Q108	0TR387500AA	2SC3875S(ALY) NPN 5V 60V 50
		Q109	0TR387500AA	2SC3875S(ALY) NPN 5V 60V 50
		Q110	0TR387500AA	2SC3875S(ALY) NPN 5V 60V 50
		Q300	0TR387500AA	2SC3875S(ALY) NPN 5V 60V 50
		Q400	0TR387500AA	2SC3875S(ALY) NPN 5V 60V 50
		Q502	0TR387500AA	2SC3875S(ALY) NPN 5V 60V 50
		Q503	0TR150400BA	2SA1504S(ASY) PNP -5V -50V
		Q504	0TR387500AA	2SC3875S(ALY) NPN 5V 60V 50
		Q505	0TR150400BA	2SA1504S(ASY) PNP -5V -50V
		Q605	0TR102009AM	KRA102S PNP -30V - -50V -0.
		Q606	0TR150400BA	2SA1504S(ASY) PNP -5V -50V
		Q607	0TR387500AA	2SC3875S(ALY) NPN 5V 60V 50
		Q608	0TR150400BA	2SA1504S(ASY) PNP -5V -50V
		Q801	0TR387500AA	2SC3875S(ALY) NPN 5V 60V 50
		Q802	0TR387500AA	2SC3875S(ALY) NPN 5V 60V 50
		Q111	0TR387500AA	2SC3875S(ALY) NPN 5V 60V 50
		Q112	0TR387500AA	2SC3875S(ALY) NPN 5V 60V 50
		Q113	0TR387500AA	2SC3875S(ALY) NPN 5V 60V 50
		Q301	0TR387500AA	2SC3875S(ALY) NPN 5V 60V 50
		Q512	0TR387500AA	2SC3875S(ALY) NPN 5V 60V 50
		Q513	0TR387500AA	2SC3875S(ALY) NPN 5V 60V 50
		Q611	0TR387500AA	2SC3875S(ALY) NPN 5V 60V 50
		Q613	0TR150400BA	2SA1504S(ASY) PNP -5V -50V
		Q901	0TR387500AA	2SC3875S(ALY) NPN 5V 60V 50
		Q902	0TR387500AA	2SC3875S(ALY) NPN 5V 60V 50
		Q903	0TR387500AA	2SC3875S(ALY) NPN 5V 60V 50
		Q904	0TR387500AA	2SC3875S(ALY) NPN 5V 60V 50
		Q905	0TR387500AA	2SC3875S(ALY) NPN 5V 60V 50
		Q906	0TR387500AA	2SC3875S(ALY) NPN 5V 60V 50
		Q907	0TR387500AA	2SC3875S(ALY) NPN 5V 60V 50
		Q908	0TR387500AA	2SC3875S(ALY) NPN 5V 60V 50
RESISTORS				
		R525	ORD0331H609	RD-92T1J3R30 3.3OHM 5% 1/2W
		R1001	0RJ0752D677	MCR03EZPJ750 75OHM 5% 1/10W
		R1002	0RJ0752D677	MCR03EZPJ750 75OHM 5% 1/10W
		R1007	0RJ0000D677	MCR03EZPJ000 0OHM 5% 1/10W
		R1011	0RJ0000D677	MCR03EZPJ000 0OHM 5% 1/10W
		R141	0RJ0752D677	MCR03EZPJ750 75OHM 5% 1/10W
		R149	0RJ2000D677	MCR03EZPJ201 200OHM 5% 1/10
		R174	0RJ2203D677	MCR03EZPJ224 220KOHM 5% 1/1

DATE: 2006. 03. 25.				
*S	*AL	LOC. NO.	PART NO.	DESCRIPTION / SPECIFICATION
		R175	0RJ2203D677	MCR03EZPJ224 220KOHM 5% 1/1
		R176	0RJ0752D677	MCR03EZPJ750 75OHM 5% 1/10W
		R177	0RJ0752D677	MCR03EZPJ750 75OHM 5% 1/10W
		R178	0RJ0752D677	MCR03EZPJ750 75OHM 5% 1/10W
		R179	0RJ2203D677	MCR03EZPJ224 220KOHM 5% 1/1
		R180	0RJ2203D677	MCR03EZPJ224 220KOHM 5% 1/1
		R181	0RJ0752D677	MCR03EZPJ750 75OHM 5% 1/10W
		R182	0RJ0752D677	MCR03EZPJ750 75OHM 5% 1/10W
		R183	0RJ0752D677	MCR03EZPJ750 75OHM 5% 1/10W
		R184	0RJ0752D677	MCR03EZPJ750 75OHM 5% 1/10W
		R185	0RJ2203D677	MCR03EZPJ224 220KOHM 5% 1/1
		R186	0RJ1001D677	MCR03EZPJ102 1KOHM 5% 1/10W
		R187	0RJ1001D677	MCR03EZPJ102 1KOHM 5% 1/10W
		R188	0RJ0000D677	MCR03EZPJ000 0OHM 5% 1/10W
		R189	0RJ0000D677	MCR03EZPJ000 0OHM 5% 1/10W
		R190	0RJ0000D677	MCR03EZPJ000 0OHM 5% 1/10W
		R191	0RJ0752D677	MCR03EZPJ750 75OHM 5% 1/10W
		R192	0RJ1001D677	MCR03EZPJ102 1KOHM 5% 1/10W
		R193	0RJ1001D677	MCR03EZPJ102 1KOHM 5% 1/10W
		R194	0RJ0000D677	MCR03EZPJ000 0OHM 5% 1/10W
		R195	0RJ0000D677	MCR03EZPJ000 0OHM 5% 1/10W
		R196	0RJ0000D677	MCR03EZPJ000 0OHM 5% 1/10W
		R197	0RJ2203D677	MCR03EZPJ224 220KOHM 5% 1/1
		R198	0RJ0752D677	MCR03EZPJ750 75OHM 5% 1/10W
		R199	0RJ0752D677	MCR03EZPJ750 75OHM 5% 1/10W
		R200	0RJ0000D677	MCR03EZPJ000 0OHM 5% 1/10W
		R201	0RJ1002D677	MCR03EZPJ103 10KOHM 5% 1/10
		R204	0RJ1002D677	MCR03EZPJ103 10KOHM 5% 1/10
		R206	0RJ1002D677	MCR03EZPJ103 10KOHM 5% 1/10
		R208	0RJ0000D677	MCR03EZPJ000 0OHM 5% 1/10W
		R209	0RJ0000D677	MCR03EZPJ000 0OHM 5% 1/10W
		R210	0RJ4703D677	MCR03EZPJ474 470KOHM 5% 1/1
		R211	0RJ4703D677	MCR03EZPJ474 470KOHM 5% 1/1
		R212	0RJ2203D677	MCR03EZPJ224 220KOHM 5% 1/1
		R213	0RJ2203D677	MCR03EZPJ224 220KOHM 5% 1/1
		R214	0RJ0000D677	MCR03EZPJ000 0OHM 5% 1/10W
		R215	0RJ0000D677	MCR03EZPJ000 0OHM 5% 1/10W
		R217	0RJ1001D677	MCR03EZPJ102 1KOHM 5% 1/10W
		R218	0RJ1001D677	MCR03EZPJ102 1KOHM 5% 1/10W
		R219	0RJ2001D677	MCR03EZPJ202 2KOHM 5% 1/10W
		R220	0RJ2001D677	MCR03EZPJ202 2KOHM 5% 1/10W
		R303	0RJ2203D677	MCR03EZPJ224 220KOHM 5% 1/1
		R304	0RJ2203D677	MCR03EZPJ224 220KOHM 5% 1/1
		R307	0RJ0752D677	MCR03EZPJ750 75OHM 5% 1/10W
		R308	0RJ1002D677	MCR03EZPJ103 10KOHM 5% 1/10
		R309	0RJ0000D677	MCR03EZPJ000 0OHM 5% 1/10W
		R310	0RJ1001D677	MCR03EZPJ102 1KOHM 5% 1/10W
		R311	0RJ1001D677	MCR03EZPJ102 1KOHM 5% 1/10W
		R312	0RJ0000D677	MCR03EZPJ000 0OHM 5% 1/10W
		R313	0RJ2001D677	MCR03EZPJ202 2KOHM 5% 1/10W
		R314	0RJ0000D677	MCR03EZPJ000 0OHM 5% 1/10W
		R315	0RJ1002D677	MCR03EZPJ103 10KOHM 5% 1/10
		R316	0RJ0752D677	MCR03EZPJ750 75OHM 5% 1/10W
		R317	0RJ0000D677	MCR03EZPJ000 0OHM 5% 1/10W
		R320	0RJ0752D677	MCR03EZPJ750 75OHM 5% 1/10W
		R321	0RJ4701D677	MCR03EZPJ472 4.7KOHM 5% 1/1
		R322	0RJ4701D677	MCR03EZPJ472 4.7KOHM 5% 1/1
		R323	0RJ1002D677	MCR03EZPJ103 10KOHM 5% 1/10
		R326	0RJ0000D677	MCR03EZPJ000 0OHM 5% 1/10W
		R327	0RJ0000D677	MCR03EZPJ000 0OHM 5% 1/10W
		R328	0RJ0000D677	MCR03EZPJ000 0OHM 5% 1/10W
		R329	0RJ0000D677	MCR03EZPJ000 0OHM 5% 1/10W

DATE: 2006. 03. 25.				
*S	*AL	LOC. NO.	PART NO.	DESCRIPTION / SPECIFICATION
		R330	0RJ1001D677	MCR03EZPJ102 1KOHM 5% 1/10W
		R331	0RJ0000D677	MCR03EZPJ000 0OHM 5% 1/10W
		R332	0RJ1001D677	MCR03EZPJ102 1KOHM 5% 1/10W
		R333	0RJ0000D677	MCR03EZPJ000 0OHM 5% 1/10W
		R334	0RJ0000D677	MCR03EZPJ000 0OHM 5% 1/10W
		R335	0RJ0000D677	MCR03EZPJ000 0OHM 5% 1/10W
		R338	0RJ1000D677	MCR03EZPJ101 100OHM 5% 1/10
		R339	0RJ1000D677	MCR03EZPJ101 100OHM 5% 1/10
		R344	0RJ2002D677	MCR03EZPJ203. 20KOHM 5% 1/1
		R349	0RJ2202D677	MCR03EZPJ223 22KOHM 5% 1/10
		R350	0RJ2202D677	MCR03EZPJ223 22KOHM 5% 1/10
		R351	0RJ0000D677	MCR03EZPJ000 0OHM 5% 1/10W
		R352	0RJ0000D677	MCR03EZPJ000 0OHM 5% 1/10W
		R355	0RJ4700D677	MCR03EZPJ471 470OHM 5% 1/10
		R358	0RJ0000D677	MCR03EZPJ000 0OHM 5% 1/10W
		R360	0RJ0000D677	MCR03EZPJ000 0OHM 5% 1/10W
		R370	0RJ0000D677	MCR03EZPJ000 0OHM 5% 1/10W
		R372	0RJ1001D677	MCR03EZPJ102 1KOHM 5% 1/10W
		R373	0RJ1001D677	MCR03EZPJ102 1KOHM 5% 1/10W
		R402	0RJ1002D677	MCR03EZPJ103 10KOHM 5% 1/10
		R404	0RJ1001D677	MCR03EZPJ102 1KOHM 5% 1/10W
		R405	0RJ1001D677	MCR03EZPJ102 1KOHM 5% 1/10W
		R417	0RJ4702D677	MCR03EZPJ473 47KOHM 5% 1/10
		R418	0RJ4702D677	MCR03EZPJ473 47KOHM 5% 1/10
		R423	0RJ1002D677	MCR03EZPJ103 10KOHM 5% 1/10
		R424	0RJ1002D677	MCR03EZPJ103 10KOHM 5% 1/10
		R502	0RJ1002D677	MCR03EZPJ103 10KOHM 5% 1/10
		R503	0RJ0222D677	MCR03EZPJ220 22OHM 5% 1/10W
		R506	0RJ1001D677	MCR03EZPJ102 1KOHM 5% 1/10W
		R507	0RJ0000D677	MCR03EZPJ000 0OHM 5% 1/10W
		R508	0RJ2200D677	MCR03EZPJ221 220OHM 5% 1/10
		R509	0RJ2200D677	MCR03EZPJ221 220OHM 5% 1/10
		R510	0RJ4701D677	MCR03EZPJ472 4.7KOHM 5% 1/1
		R511	0RJ4700D677	MCR03EZPJ471 470OHM 5% 1/10
		R512	0RJ0822D677	MCR03EZPJ820 82OHM 5% 1/10W
		R513	0RJ0000D677	MCR03EZPJ000 0OHM 5% 1/10W
		R514	0RJ0000D677	MCR03EZPJ000 0OHM 5% 1/10W
		R515	0RJ1000D677	MCR03EZPJ101 100OHM 5% 1/10
		R516	0RJ1001D677	MCR03EZPJ102 1KOHM 5% 1/10W
		R517	0RJ4701D677	MCR03EZPJ472 4.7KOHM 5% 1/1
		R521	0RJ1001D677	MCR03EZPJ102 1KOHM 5% 1/10W
		R532	0RJ3002D677	MCR03EZPJ303 30KOHM 5% 1/10
		R533	0RJ2201D677	MCR03EZPJ222 2.2KOHM 5% 1/1
		R539	0RJ2702D677	MCR03EZPJ273 27KOHM 5% 1/10
		R540	0RJ7501D677	MCR03EZPJ752 7.5KOHM 5% 1/1
		R603	0RJ1000D677	MCR03EZPJ101 100OHM 5% 1/10
		R646	0RJ0000D677	MCR03EZPJ000 0OHM 5% 1/10W
		R656	0RJ1000D677	MCR03EZPJ101 100OHM 5% 1/10
		R657	0RJ0000D677	MCR03EZPJ000 0OHM 5% 1/10W
		R658	0RJ0000D677	MCR03EZPJ000 0OHM 5% 1/10W
		R673	0RJ6201D677	MCR03EZPJ622 6.2KOHM 5% 1/1
		R736	0RJ1000D677	MCR03EZPJ101 100OHM 5% 1/10
		R747	0RJ1000D677	MCR03EZPJ101 100OHM 5% 1/10
		R748	0RJ1000D677	MCR03EZPJ101 100OHM 5% 1/10
		R749	0RJ1000D677	MCR03EZPJ101 100OHM 5% 1/10
		R762	0RJ1001D677	MCR03EZPJ102 1KOHM 5% 1/10W
		R763	0RJ1001D677	MCR03EZPJ102 1KOHM 5% 1/10W
		R764	0RJ1001D677	MCR03EZPJ102 1KOHM 5% 1/10W
		R765	0RJ1001D677	MCR03EZPJ102 1KOHM 5% 1/10W
		R766	0RJ1001D677	MCR03EZPJ102 1KOHM 5% 1/10W
		R767	0RJ1001D677	MCR03EZPJ102 1KOHM 5% 1/10W
		R768	0RJ1001D677	MCR03EZPJ102 1KOHM 5% 1/10W

DATE: 2006. 03. 25.				
*S	*AL	LOC. NO.	PART NO.	DESCRIPTION / SPECIFICATION
		R769	0RJ1001D677	MCR03EZPJ102 1KOHM 5% 1/10W
		R771	0RJ2200D677	MCR03EZPJ221 220OHM 5% 1/10
		R776	0RJ0000D677	MCR03EZPJ000 0OHM 5% 1/10W
		R781	0RJ3001D677	MCR03EZPJ302 30KOHM 5% 1/10W
		R782	0RJ3001D677	MCR03EZPJ302 30KOHM 5% 1/10W
		R783	0RJ0000D677	MCR03EZPJ000 0OHM 5% 1/10W
		R784	0RJ0000D677	MCR03EZPJ000 0OHM 5% 1/10W
		R800	0RJ1000D477	MCR03EZPF101 100OHM 1% 1/10
		R801	0RJ1000D477	MCR03EZPF101 100OHM 1% 1/10
		R802	0RJ1000D477	MCR03EZPF101 100OHM 1% 1/10
		R803	0RJ1000D477	MCR03EZPF101 100OHM 1% 1/10
		R804	0RJ1000D477	MCR03EZPF101 100OHM 1% 1/10
		R805	0RJ1000D477	MCR03EZPF101 100OHM 1% 1/10
		R806	0RJ1000D477	MCR03EZPF101 100OHM 1% 1/10
		R807	0RJ1000D477	MCR03EZPF101 100OHM 1% 1/10
		R808	0RJ1000D477	MCR03EZPF101 100OHM 1% 1/10
		R809	0RJ1000D477	MCR03EZPF101 100OHM 1% 1/10
		R810	0RJ1000D477	MCR03EZPF101 100OHM 1% 1/10
		R811	0RJ1000D477	MCR03EZPF101 100OHM 1% 1/10
		R812	0RJ1000D477	MCR03EZPF101 100OHM 1% 1/10
		R813	0RJ1000D477	MCR03EZPF101 100OHM 1% 1/10
		R816	0RJ1000D677	MCR03EZPJ101 100OHM 5% 1/10
		R822	0RJ2001D677	MCR03EZPJ202 2KOHM 5% 1/10W
		R823	0RJ2001D677	MCR03EZPJ202 2KOHM 5% 1/10W
		R828	0RJ4703D677	MCR03EZPJ474 470KOHM 5% 1/1
		R829	0RJ4703D677	MCR03EZPJ474 470KOHM 5% 1/1
		R833	0RJ0000D677	MCR03EZPJ000 0OHM 5% 1/10W
		R834	0RJ0000D677	MCR03EZPJ000 0OHM 5% 1/10W
		R838	0RJ2001D677	MCR03EZPJ202 2KOHM 5% 1/10W
		R839	0RJ2001D677	MCR03EZPJ202 2KOHM 5% 1/10W
		R843	0RJ1002D677	MCR03EZPJ103 10KOHM 5% 1/10
		R844	0RJ1002D677	MCR03EZPJ103 10KOHM 5% 1/10
		R847	0RJ1003D677	MCR03EZPJ104 100KOHM 5% 1/1
		R848	0RJ1000D677	MCR03EZPJ101 100OHM 5% 1/10
		R849	0RJ1001D677	MCR03EZPJ102 1KOHM 5% 1/10W
		R850	0RJ1001D677	MCR03EZPJ102 1KOHM 5% 1/10W
		R851	0RJ4701D677	MCR03EZPJ472 4.7KOHM 5% 1/1
		R852	0RJ4701D677	MCR03EZPJ472 4.7KOHM 5% 1/1
		R856	0RJ0000D677	MCR03EZPJ000 0OHM 5% 1/10W
		R857	0RJ0000D677	MCR03EZPJ000 0OHM 5% 1/10W
		R861	0RJ0000D677	MCR03EZPJ000 0OHM 5% 1/10W
		R865	0RJ0000D677	MCR03EZPJ000 0OHM 5% 1/10W
		R866	0RJ0000D677	MCR03EZPJ000 0OHM 5% 1/10W
		R867	0RJ0000D677	MCR03EZPJ000 0OHM 5% 1/10W
		R868	0RJ0000D677	MCR03EZPJ000 0OHM 5% 1/10W
		R872	0RJ0000D677	MCR03EZPJ000 0OHM 5% 1/10W
		R876	0RJ0000D677	MCR03EZPJ000 0OHM 5% 1/10W
		R900	0RJ1002D677	MCR03EZPJ103 10KOHM 5% 1/10
		R902	0RJ1001D677	MCR03EZPJ102 1KOHM 5% 1/10W
		R909	0RJ1001D677	MCR03EZPJ102 1KOHM 5% 1/10W
		R910	0RJ1001D677	MCR03EZPJ102 1KOHM 5% 1/10W
		R916	0RJ1002D677	MCR03EZPJ103 10KOHM 5% 1/10
		R918	0RJ1002D677	MCR03EZPJ103 10KOHM 5% 1/10
		R919	0RJ1002D677	MCR03EZPJ103 10KOHM 5% 1/10
		R922	0RJ1102D677	MCR03EZPJ113 11KOHM 5% 1/10
		R923	0RJ2002D677	MCR03EZPJ203. 20KOHM 5% 1/1
		R926	0RJ1001D677	MCR03EZPJ102 1KOHM 5% 1/10W
		R927	0RJ1002D677	MCR03EZPJ103 10KOHM 5% 1/10
		R930	0RJ0000D677	MCR03EZPJ000 0OHM 5% 1/10W
		R932	0RJ0000D677	MCR03EZPJ000 0OHM 5% 1/10W
		R933	0RH0000D622	MCR10EZHJ000 0OHM 5% 1/8W 2
		R934	0RH0000D622	MCR10EZHJ000 0OHM 5% 1/8W 2

DATE: 2006. 03. 25.				
*S	*AL	LOC. NO.	PART NO.	DESCRIPTION / SPECIFICATION
		R935	ORH0000D622	MCR10EZHJ000 0OHM 5% 1/8W 2
		R937	ORJ0000D677	MCR03EZPJ000 0OHM 5% 1/10W
		R938	ORJ0000D677	MCR03EZPJ000 0OHM 5% 1/10W
		C644	ORJ0000D677	MCR03EZPJ000 0OHM 5% 1/10W
		C646	ORJ0000D677	MCR03EZPJ000 0OHM 5% 1/10W
		L922	ORH0332D622	MCR10EZHJ330 33OHM 5% 1/8W
		R1000	ORJ1201D677	MCR03EZPJ122 1.2KOHM 5% 1/1
		R1003	ORJ1002D677	MCR03EZPJ103 10KOHM 5% 1/10
		R1004	ORJ1002D677	MCR03EZPJ103 10KOHM 5% 1/10
		R1005	ORJ1002D677	MCR03EZPJ103 10KOHM 5% 1/10
		R1006	ORJ2002D677	MCR03EZPJ203. 20KOHM 5% 1/1
		R1009	ORJ0000D677	MCR03EZPJ000 0OHM 5% 1/10W
		R222	ORJ1001D677	MCR03EZPJ102 1KOHM 5% 1/10W
		R223	ORJ1001D677	MCR03EZPJ102 1KOHM 5% 1/10W
		R224	ORJ1001D677	MCR03EZPJ102 1KOHM 5% 1/10W
		R225	ORJ1001D677	MCR03EZPJ102 1KOHM 5% 1/10W
		R226	ORJ4701D677	MCR03EZPJ472 4.7KOHM 5% 1/1
		R227	ORJ4701D677	MCR03EZPJ472 4.7KOHM 5% 1/1
		R228	ORJ4701D677	MCR03EZPJ472 4.7KOHM 5% 1/1
		R229	ORJ4701D677	MCR03EZPJ472 4.7KOHM 5% 1/1
		R300	ORJ0000D677	MCR03EZPJ000 0OHM 5% 1/10W
		R301	ORJ0000D677	MCR03EZPJ000 0OHM 5% 1/10W
		R302	ORJ0000D677	MCR03EZPJ000 0OHM 5% 1/10W
		R306	ORJ1001D677	MCR03EZPJ102 1KOHM 5% 1/10W
		R318	ORJ1000D677	MCR03EZPJ101 100OHM 5% 1/10
		R319	ORJ1000D677	MCR03EZPJ101 100OHM 5% 1/10
		R343	ORJ2002D677	MCR03EZPJ203. 20KOHM 5% 1/1
		R345	ORJ1000D677	MCR03EZPJ101 100OHM 5% 1/10
		R346	ORJ1000D677	MCR03EZPJ101 100OHM 5% 1/10
		R347	ORJ3001D677	MCR03EZPJ302 3KOHM 5% 1/10W
		R348	ORJ3001D677	MCR03EZPJ302 3KOHM 5% 1/10W
		R361	ORJ1000D677	MCR03EZPJ101 100OHM 5% 1/10
		R362	ORJ1000D677	MCR03EZPJ101 100OHM 5% 1/10
		R366	ORJ1000D677	MCR03EZPJ101 100OHM 5% 1/10
		R367	ORJ1000D677	MCR03EZPJ101 100OHM 5% 1/10
		R380	ORJ0000D677	MCR03EZPJ000 0OHM 5% 1/10W
		R381	ORJ0000D677	MCR03EZPJ000 0OHM 5% 1/10W
		R382	ORJ0000D677	MCR03EZPJ000 0OHM 5% 1/10W
		R383	ORJ0000D677	MCR03EZPJ000 0OHM 5% 1/10W
		R384	ORJ4701D677	MCR03EZPJ472 4.7KOHM 5% 1/1
		R386	ORJ0000D677	MCR03EZPJ000 0OHM 5% 1/10W
		R387	ORJ0000D677	MCR03EZPJ000 0OHM 5% 1/10W
		R388	ORJ0000D677	MCR03EZPJ000 0OHM 5% 1/10W
		R389	ORJ4700D677	MCR03EZPJ471 470OHM 5% 1/10
		R401	ORJ0000D677	MCR03EZPJ000 0OHM 5% 1/10W
		R406	ORJ1000D677	MCR03EZPJ101 100OHM 5% 1/10
		R407	ORJ1000D677	MCR03EZPJ101 100OHM 5% 1/10
		R421	ORJ1000D677	MCR03EZPJ101 100OHM 5% 1/10
		R422	ORJ1000D677	MCR03EZPJ101 100OHM 5% 1/10
		R425	ORJ4990D477	MCR03EZPF4990 499OHM 1% 1/1
		R426	ORJ0222D677	MCR03EZPJ220 22OHM 5% 1/10W
		R427	ORJ0222D677	MCR03EZPJ220 22OHM 5% 1/10W
		R428	ORJ0222D677	MCR03EZPJ220 22OHM 5% 1/10W
		R433	ORJ1000D677	MCR03EZPJ101 100OHM 5% 1/10
		R434	ORJ1000D677	MCR03EZPJ101 100OHM 5% 1/10
		R435	ORJ0222D677	MCR03EZPJ220 22OHM 5% 1/10W
		R436	ORJ0222D677	MCR03EZPJ220 22OHM 5% 1/10W
		R437	ORJ0222D677	MCR03EZPJ220 22OHM 5% 1/10W
		R438	ORJ0222D677	MCR03EZPJ220 22OHM 5% 1/10W
		R441	ORJ1002D677	MCR03EZPJ103 10KOHM 5% 1/10
		R442	ORJ1002D677	MCR03EZPJ103 10KOHM 5% 1/10
		R451	ORJ1501D677	MCR03EZPJ152 1.5KOHM 5% 1/1

DATE: 2006. 03. 25.				
*S	*AL	LOC. NO.	PART NO.	DESCRIPTION / SPECIFICATION
		R519	ORJ2700D677	MCR03EZPJ271 270OHM 5% 1/10
		R520	ORJ2200D677	MCR03EZPJ221 220OHM 5% 1/10
		R528	ORJ1800D677	MCR03EZPJ181 180OHM 5% 1/10
		R534	ORJ1001D677	MCR03EZPJ102 1KOHM 5% 1/10W
		R535	ORJ4702D677	MCR03EZPJ473 47KOHM 5% 1/10
		R536	ORJ1001D677	MCR03EZPJ102 1KOHM 5% 1/10W
		R600	ORJ0000D677	MCR03EZPJ000 0OHM 5% 1/10W
		R601	ORJ1000D677	MCR03EZPJ101 100OHM 5% 1/10
		R615	ORJ0000D677	MCR03EZPJ000 0OHM 5% 1/10W
		R616	ORJ0000D677	MCR03EZPJ000 0OHM 5% 1/10W
		R617	ORJ0000D677	MCR03EZPJ000 0OHM 5% 1/10W
		R620	ORJ1000D677	MCR03EZPJ101 100OHM 5% 1/10
		R621	ORJ0000D677	MCR03EZPJ000 0OHM 5% 1/10W
		R627	ORJ0000D677	MCR03EZPJ000 0OHM 5% 1/10W
		R628	ORJ0000D677	MCR03EZPJ000 0OHM 5% 1/10W
		R629	ORJ1500D677	MCR03EZPJ151 150OHM 5% 1/10
		R630	ORJ4700D677	MCR03EZPJ471 470OHM 5% 1/10
		R631	ORJ1500D677	MCR03EZPJ151 150OHM 5% 1/10
		R632	ORJ1802D677	MCR03EZPJ183 18KOHM 5% 1/10
		R633	ORJ1000D677	MCR03EZPJ101 100OHM 5% 1/10
		R634	ORJ1000D677	MCR03EZPJ101 100OHM 5% 1/10
		R635	ORJ1000D677	MCR03EZPJ101 100OHM 5% 1/10
		R636	ORJ1000D677	MCR03EZPJ101 100OHM 5% 1/10
		R637	ORJ1000D677	MCR03EZPJ101 100OHM 5% 1/10
		R638	ORJ1001D677	MCR03EZPJ102 1KOHM 5% 1/10W
		R640	ORJ1000D677	MCR03EZPJ101 100OHM 5% 1/10
		R645	ORJ1000D677	MCR03EZPJ101 100OHM 5% 1/10
		R647	ORJ1002D677	MCR03EZPJ103 10KOHM 5% 1/10
		R648	ORJ1002D677	MCR03EZPJ103 10KOHM 5% 1/10
		R649	ORJ1002D677	MCR03EZPJ103 10KOHM 5% 1/10
		R650	ORJ1002D677	MCR03EZPJ103 10KOHM 5% 1/10
		R651	ORJ1002D677	MCR03EZPJ103 10KOHM 5% 1/10
		R652	ORJ1002D677	MCR03EZPJ103 10KOHM 5% 1/10
		R653	ORJ1000D677	MCR03EZPJ101 100OHM 5% 1/10
		R654	ORJ1000D677	MCR03EZPJ101 100OHM 5% 1/10
		R660	ORJ8201D677	MCR03EZPJ822 8.2KOHM 5% 1/1
		R662	ORJ1002D677	MCR03EZPJ103 10KOHM 5% 1/10
		R663	ORJ1002D677	MCR03EZPJ103 10KOHM 5% 1/10
		R664	ORJ1001D677	MCR03EZPJ102 1KOHM 5% 1/10W
		R665	ORJ1001D677	MCR03EZPJ102 1KOHM 5% 1/10W
		R666	ORJ4701D677	MCR03EZPJ472 4.7KOHM 5% 1/1
		R667	ORJ1000D677	MCR03EZPJ101 100OHM 5% 1/10
		R668	ORJ1000D677	MCR03EZPJ101 100OHM 5% 1/10
		R670	ORJ1000D677	MCR03EZPJ101 100OHM 5% 1/10
		R671	ORJ4701D677	MCR03EZPJ472 4.7KOHM 5% 1/1
		R672	ORJ1000D677	MCR03EZPJ101 100OHM 5% 1/10
		R675	ORJ1000D677	MCR03EZPJ101 100OHM 5% 1/10
		R676	ORJ1000D677	MCR03EZPJ101 100OHM 5% 1/10
		R677	ORJ1000D677	MCR03EZPJ101 100OHM 5% 1/10
		R678	ORJ1000D677	MCR03EZPJ101 100OHM 5% 1/10
		R679	ORJ1000D677	MCR03EZPJ101 100OHM 5% 1/10
		R680	ORJ1000D677	MCR03EZPJ101 100OHM 5% 1/10
		R681	ORJ2001D677	MCR03EZPJ202 2KOHM 5% 1/10W
		R686	ORJ1000D677	MCR03EZPJ101 100OHM 5% 1/10
		R687	ORJ1000D677	MCR03EZPJ101 100OHM 5% 1/10
		R689	ORJ2200D677	MCR03EZPJ221 220OHM 5% 1/10
		R690	ORJ1000D677	MCR03EZPJ101 100OHM 5% 1/10
		R691	ORJ2200D677	MCR03EZPJ221 220OHM 5% 1/10
		R692	ORJ1000D677	MCR03EZPJ101 100OHM 5% 1/10
		R693	ORJ2200D677	MCR03EZPJ221 220OHM 5% 1/10
		R694	ORJ1000D677	MCR03EZPJ101 100OHM 5% 1/10
		R695	ORJ0222D677	MCR03EZPJ220 22OHM 5% 1/10W

DATE: 2006. 03. 25.				
*S	*AL	LOC. NO.	PART NO.	DESCRIPTION / SPECIFICATION
		R697	0RJ2001D677	MCR03EZPJ202 2KOHM 5% 1/10W
		R699	0RJ1000D677	MCR03EZPJ101 100OHM 5% 1/10
		R700	0RJ1000D677	MCR03EZPJ101 100OHM 5% 1/10
		R702	0RJ1000D677	MCR03EZPJ101 100OHM 5% 1/10
		R703	0RJ1000D677	MCR03EZPJ101 100OHM 5% 1/10
		R704	0RJ6202D677	MCR03EZPJ623 62KOHM 5% 1/10
		R705	0RJ2402D677	MCR03EZPJ243 24KOHM 5% 1/10
		R708	0RJ1501D677	MCR03EZPJ152 1.5KOHM 5% 1/1
		R709	0RJ4700D677	MCR03EZPJ471 470OHM 5% 1/10
		R711	0RJ0222D677	MCR03EZPJ220 22OHM 5% 1/10W
		R712	0RJ0222D677	MCR03EZPJ220 22OHM 5% 1/10W
		R713	0RJ0222D677	MCR03EZPJ220 22OHM 5% 1/10W
		R714	0RJ2200D677	MCR03EZPJ221 220OHM 5% 1/10
		R715	0RJ2200D677	MCR03EZPJ221 220OHM 5% 1/10
		R718	0RJ4701D677	MCR03EZPJ472 4.7KOHM 5% 1/1
		R721	0RJ4701D677	MCR03EZPJ472 4.7KOHM 5% 1/1
		R728	0RJ1000D677	MCR03EZPJ101 100OHM 5% 1/10
		R729	0RJ1000D677	MCR03EZPJ101 100OHM 5% 1/10
		R730	0RJ1000D677	MCR03EZPJ101 100OHM 5% 1/10
		R732	0RJ1000D677	MCR03EZPJ101 100OHM 5% 1/10
		R733	0RJ1000D677	MCR03EZPJ101 100OHM 5% 1/10
		R734	0RJ1000D677	MCR03EZPJ101 100OHM 5% 1/10
		R735	0RJ0000D677	MCR03EZPJ000 0OHM 5% 1/10W
		R737	0RJ1000D677	MCR03EZPJ101 100OHM 5% 1/10
		R742	0RJ6201D677	MCR03EZPJ622 6.2KOHM 5% 1/1
		R744	0RJ1001D677	MCR03EZPJ102 1KOHM 5% 1/10W
		R750	0RJ0000D677	MCR03EZPJ000 0OHM 5% 1/10W
		R751	0RJ1000D677	MCR03EZPJ101 100OHM 5% 1/10
		R752	0RJ1000D677	MCR03EZPJ101 100OHM 5% 1/10
		R753	0RJ1000D677	MCR03EZPJ101 100OHM 5% 1/10
		R756	0RJ1000D677	MCR03EZPJ101 100OHM 5% 1/10
		R757	0RJ1000D677	MCR03EZPJ101 100OHM 5% 1/10
		R758	0RJ1001D677	MCR03EZPJ102 1KOHM 5% 1/10W
		R759	0RJ1001D677	MCR03EZPJ102 1KOHM 5% 1/10W
		R760	0RJ1001D677	MCR03EZPJ102 1KOHM 5% 1/10W
		R761	0RJ1001D677	MCR03EZPJ102 1KOHM 5% 1/10W
		R772	0RJ2200D677	MCR03EZPJ221 220OHM 5% 1/10
		R778	0RJ0000D677	MCR03EZPJ000 0OHM 5% 1/10W
		R780	0RJ0000D677	MCR03EZPJ000 0OHM 5% 1/10W
		R785	0RJ0000D677	MCR03EZPJ000 0OHM 5% 1/10W
		R855	0RJ0000D677	MCR03EZPJ000 0OHM 5% 1/10W
		R858	0RJ0000D677	MCR03EZPJ000 0OHM 5% 1/10W
		R862	0RJ0000D677	MCR03EZPJ000 0OHM 5% 1/10W
		R863	0RJ0000D677	MCR03EZPJ000 0OHM 5% 1/10W
		R864	0RJ0000D677	MCR03EZPJ000 0OHM 5% 1/10W
		R869	0RJ0000D677	MCR03EZPJ000 0OHM 5% 1/10W
		R870	0RJ0000D677	MCR03EZPJ000 0OHM 5% 1/10W
		R871	0RJ0000D677	MCR03EZPJ000 0OHM 5% 1/10W
		R873	0RJ1002D677	MCR03EZPJ103 10KOHM 5% 1/10
		R874	0RJ0000D677	MCR03EZPJ000 0OHM 5% 1/10W
		R875	0RJ0000D677	MCR03EZPJ000 0OHM 5% 1/10W
		R905	0RJ2000D677	MCR03EZPJ201 200OHM 5% 1/10
		R906	0RJ0000D677	MCR03EZPJ000 0OHM 5% 1/10W
		R912	0RJ1002D677	MCR03EZPJ103 10KOHM 5% 1/10
		R913	0RJ1002D677	MCR03EZPJ103 10KOHM 5% 1/10
		R921	0RJ1002D677	MCR03EZPJ103 10KOHM 5% 1/10
		R924	0RJ4701D677	MCR03EZPJ472 4.7KOHM 5% 1/1
		R925	0RJ0000D677	MCR03EZPJ000 0OHM 5% 1/10W
		R928	0RJ1002D677	MCR03EZPJ103 10KOHM 5% 1/10
		R929	0RJ1002D677	MCR03EZPJ103 10KOHM 5% 1/10

DATE: 2006. 03. 25.				
*S	*AL	LOC. NO.	PART NO.	DESCRIPTION / SPECIFICATION
OTHERS				
		X600	6202VDT002P	HC-49/SM 20.25000MHZ 20.25M-26LC2R
		X600	6202VDT002E	SX-1 20.25MHZ 20.25MHZ 30PP-32LC2R
		D1004	0DL233309AC	SAM2333 RED/Y-GREEN 2.7V 2.
		D750	0DL233309AC	SAM2333 RED/Y-GREEN 2.7V 2.
		SW501	6600VR1004A	SKHMPWE010 1C1P 12VDC 0.05A
CONTROL BOARD				
		SW101	140-313B	KPT-1115AM 1C1P 12VDC 0.05A
		SW102	140-313B	KPT-1115AM 1C1P 12VDC 0.05A
		SW103	140-313B	KPT-1115AM 1C1P 12VDC 0.05A
		SW104	140-313B	KPT-1115AM 1C1P 12VDC 0.05A
		SW105	140-313B	KPT-1115AM 1C1P 12VDC 0.05A
		SW106	140-313B	KPT-1115AM 1C1P 12VDC 0.05A
		SW107	140-313B	KPT-1115AM 1C1P 12VDC 0.05A
		SW108	140-313B	KPT-1115AM 1C1P 12VDC 0.05A
		R101	0RH9101D622	MCR10EZHJ912 9.1KOHM 5% 1/8
		R102	0RH3301D622	MCR10EZHJ332 3.3KOHM 5% 1/8
		R103	0RH1101D622	MCR10EZHJ112 1.1KOHM 5% 1/8
		R104	0RH0000D622	MCR10EZHJ000 0OHM 5% 1/8W 2
		R105	0RH9101D622	MCR10EZHJ912 9.1KOHM 5% 1/8
		R106	0RH3301D622	MCR10EZHJ332 3.3KOHM 5% 1/8
		R107	0RH1101D622	MCR10EZHJ112 1.1KOHM 5% 1/8
		R108	0RH0000D622	MCR10EZHJ000 0OHM 5% 1/8W 2
SIDE A/V BOARD				
		C300	0CH5101K416	C2012C0G1H101JT 100pF 5% 50
		C301	0CH5101K416	C2012C0G1H101JT 100pF 5% 50
		R300	0RH2203D622	MCR10EZHJ224 220KOHM 5% 1/8
		R301	0RH2203D622	MCR10EZHJ224 220KOHM 5% 1/8
		R302	0RH0752D622	MCR10EZHJ750 750OHM 5% 1/8W
		R303	0RH4700D622	MCR10EZHJ471 470OHM 5% 1/8W
		R304	0RH4700D622	MCR10EZHJ471 470OHM 5% 1/8W
		R305	0RH0000D622	MCR10EZHJ000 0OHM 5% 1/8W 2
PREAMP&LED BOARD				
		C200	0CH5101K416	C2012C0G1H101JT 100pF 5% 50
		C201	0CH5330K416	C2012C0G1H330JT 33pF 5% 50V
		L200	0LC1032101A	FI-C3216-103KJT 10UH 10% -
		Q200	0TR387500AA	2SC3875S(ALY) NPN 5V 60V 50
		Q201	0TR387500AA	2SC3875S(ALY) NPN 5V 60V 50
		Q202	0TR387500AA	2SC3875S(ALY) NPN 5V 60V 50
		R200	0RH0000D622	MCR10EZHJ000 0OHM 5% 1/8W 2
		R201	0RH0000D622	MCR10EZHJ000 0OHM 5% 1/8W 2
		R202	0RH6800D622	MCR10EZHJ681 680OHM 5% 1/8W
		R203	0RH0000D622	MCR10EZHJ000 0OHM 5% 1/8W 2
		R204	0RH6801D622	MCR10EZHJ682 6.8KOHM 5% 1/8
		R205	0RH0000D622	MCR10EZHJ000 0OHM 5% 1/8W 2
		R206	0RH0000D622	MCR10EZHJ000 0OHM 5% 1/8W 2
		R207	0RH0000D622	MCR10EZHJ000 0OHM 5% 1/8W 2
		R208	0RH3901D622	MCR10EZHJ392 3.9KOHM 5% 1/8
		C202	0CE4763F618	ESF476M016T1A5E05G 47uF 20%
		C203	0CE4763F618	ESF476M016T1A5E05G 47uF 20%
		D200	0DLAU0410AA	SAW5670 ROUND 5mm AMBER/WHI
		IC201	6712000013A	TSOP4438SO1 4.5TO5.5V 1.5MA

1. INPUT-1

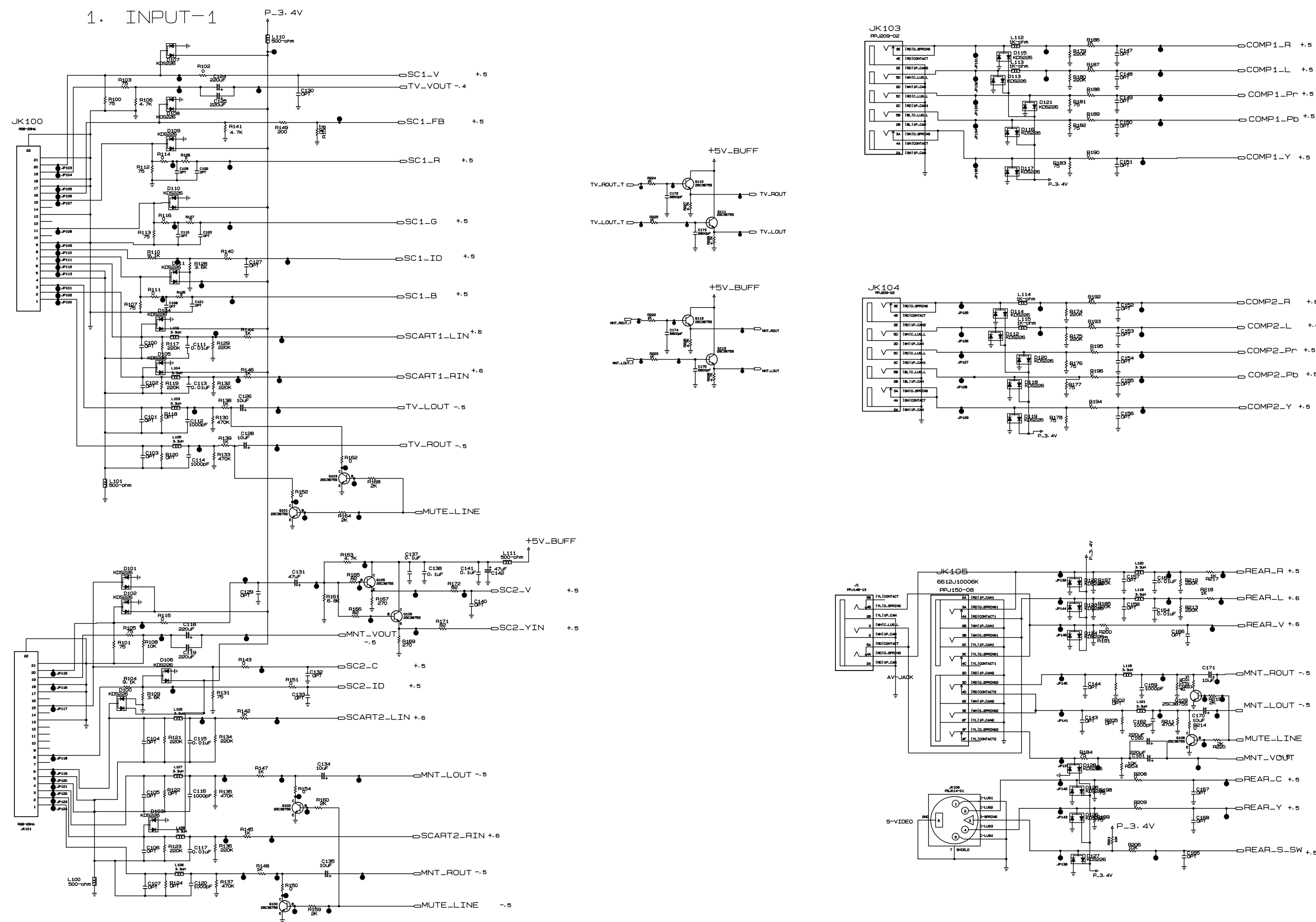

THE Δ SYMBOL MARK OF THIS SCHEMATIC DIAGRAM INCORPORATES SPECIAL FEATURES IMPORTANT FOR PROTECTION FROM X-RADIATION, FIRE AND ELECTRICAL SHOCK HAZARDS. WHEN SERVICING IT IS ESSENTIAL THAT ONLY MANUFACTURER SPECIFIED PARTS BE USED FOR THE CRITICAL COMPONENTS IN THE Δ SYMBOL MARK OF THE SCHEMATIC.

2. INPUT-2

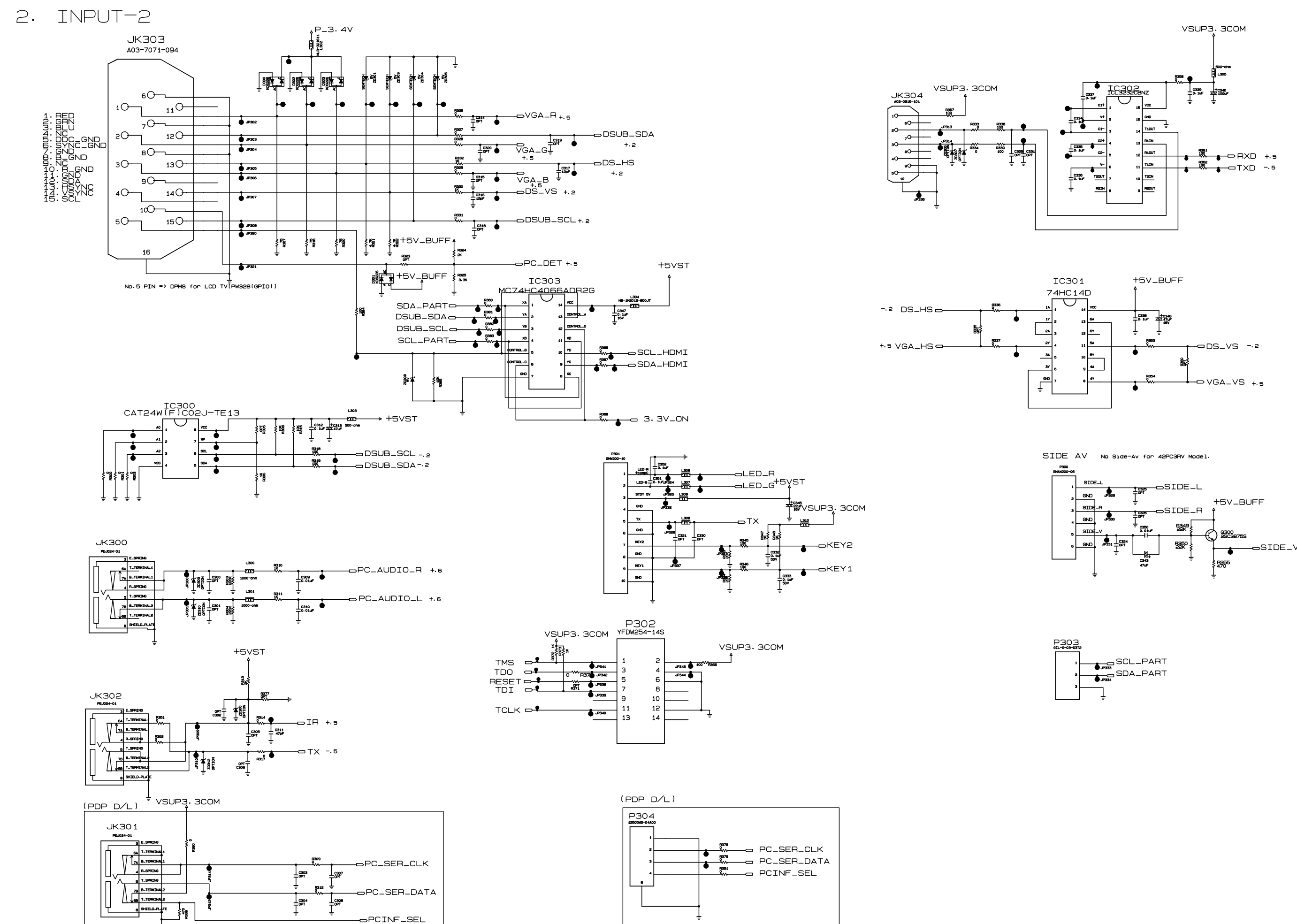

THE Δ SYMBOL MARK OF THIS SCHEMATIC DIAGRAM INCORPORATES SPECIAL FEATURES IMPORTANT FOR PROTECTION FROM X-RADIATION, FIRE AND ELECTRICAL SHOCK HAZARDS. WHEN SERVICING IT IS ESSENTIAL THAT ONLY MANUFACTURER SPECIFIED PARTS BE USED FOR THE CRITICAL COMPONENTS IN THE Δ SYMBOL MARK OF THE SCHEMATIC.

3. HDMI

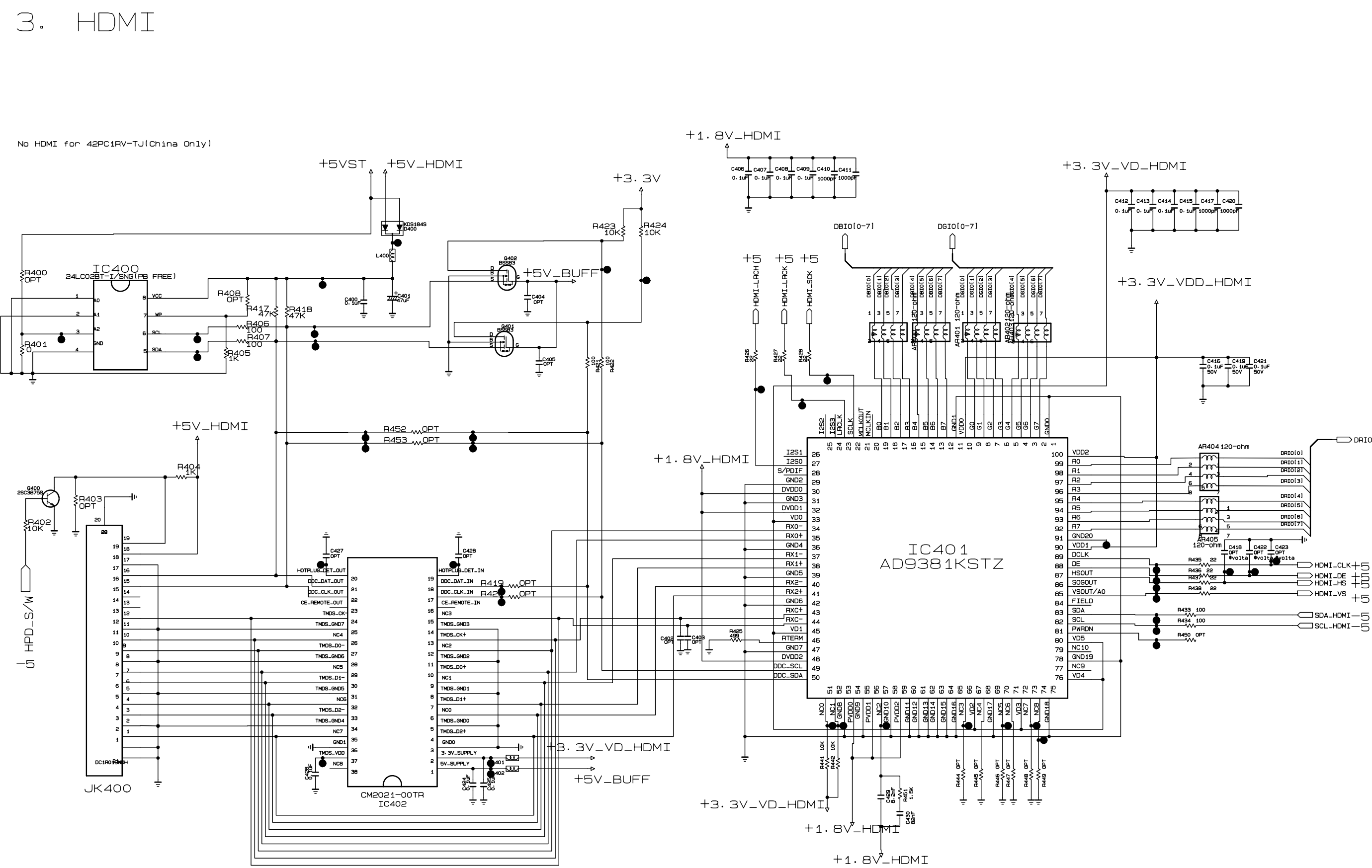

THE Δ SYMBOL MARK OF THIS SCHEMATIC DIAGRAM INCORPORATES SPECIAL FEATURES IMPORTANT FOR PROTECTION FROM X-RADIATION, FIRE AND ELECTRICAL SHOCK HAZARDS. WHEN SERVICING IT IS ESSENTIAL THAT ONLY MANUFACTURER SPECIFIED PARTS BE USED FOR THE CRITICAL COMPONENTS IN THE Δ SYMBOL MARK OF THE SCHEMATIC.

4. TUNER

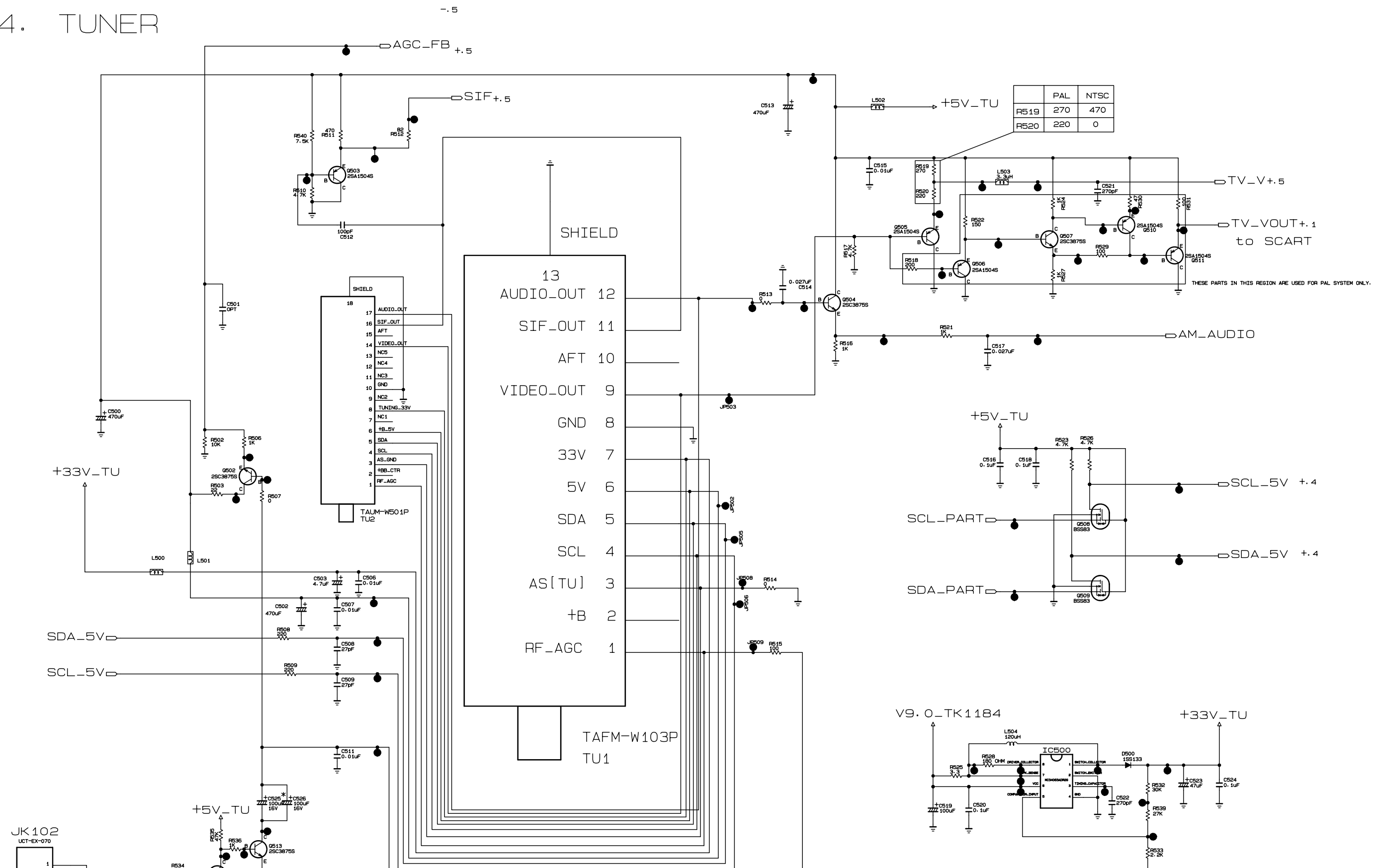



P/NO : MFL30105597

Jun., 2006
Printed in Korea