

PLEASE CHECK WWW.MOLEX.COM FOR LATEST PART INFORMATION

Part Number: [0358571649](#)
Status: **Active**
Overview:
Description: 1.00mm (.039") Pitch FFC Connector, Vertical, Non-ZIF, 16 Circuits, 2.80mm (.110")
 Straight PC Tail, Tube Packaging

Agency Certification

CSA LR19980
 UL E29179

General

Product Family FFC/FPC Connectors
 Series 35857
 Overview ffc_fpc_throughhole
 Product Name N/A

Physical

Circuits (Loaded) 16
 Color - Resin Black
 Contact Position N/A
 Durability (mating cycles max) 10
 Entry Angle Vertical
 Flammability 94V-0
 Mated Height (in) 0.205 In
 Mated Height (mm) 5.20 mm
 Material - Metal Phosphor Bronze
 Material - Plating Mating Tin
 Material - Plating Termination Tin
 Material - Resin Nylon
 Number of Rows 1
 Orientation Vertical
 PC Tail Length (in) 0.110 In
 PC Tail Length (mm) 2.80 mm
 PCB Locator No
 PCB Retention None
 Packaging Type Tube
 Pitch - Mating Interface (in) 0.039 In
 Pitch - Mating Interface (mm) 1.00 mm
 Plating min: Mating (µin) 32.00
 Plating min: Mating (µm) 0.800
 Plating min: Termination (µin) 32.00
 Plating min: Termination (µm) 0.80
 Polarized to PCB No
 Stackable No
 Temperature Range - Operating -20°C to +80°C
 Termination Interface: Style Through Hole
 Wire/Cable Type FFC/FPC

Electrical

Current - Maximum per Contact 0.5A
 Voltage - Maximum 50V

Material Info

Reference - Drawing Numbers

Packaging Specification PK-35857-001
 Product Specification PS-35857-001

EU RoHS
ELV and RoHS
Compliant
REACH SVHC
Contains SVHC: No
Halogen-Free
Status
Not Halogen-Free

China RoHS



Need more information on product environmental compliance?

Email productcompliance@molex.com
 For a multiple part number RoHS Certificate of Compliance, [click here](#)

Please visit the [Contact Us](#) section for any non-product compliance questions.

Search Parts in this Series
[35857Series](#)

This document was generated on 06/04/2010

PLEASE CHECK WWW.MOLEX.COM FOR LATEST PART INFORMATION

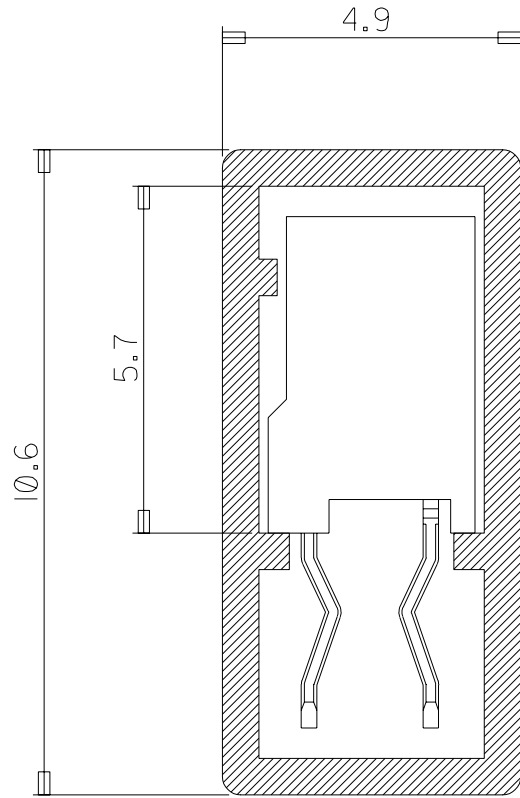

NOTE

1. ENG NO.

HSG ASS'Y	PACKING	SHAPE	
		TAIL	KINK
35857-***11	35857-***19	3.2	0
35857-***21	35857-***29	3.2	X
35857-***31	35857-***39	2.8	0
35857-***41	35857-***49	2.8	X

2. MATERIAL : PVC

3. TUBE LENGTH : 550mm

NEW RELEASED
 KOR2003-0277
 HSSHIN 20030630
 J.K.OH
 C.W.LEE

8-1 X

H.S.SHIN 99.2.26

J.K.OH 99.2.26

C.W.LEE 99.2.26

3

1

15	30	40	10
16	29	43	9
	28	47	8
17	27	52	7
	26	57	6
18	25	65	5
19	24	74	4
	23	85	3
Q'TY	CKT	Q'TY	CKT

X

TUBE PACKING
 FOR 35857 SERIES

SD-35857-***41

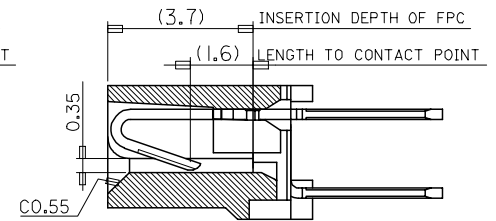
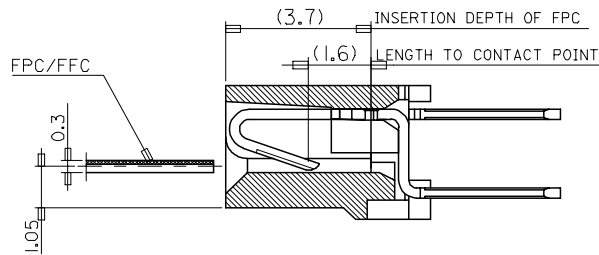
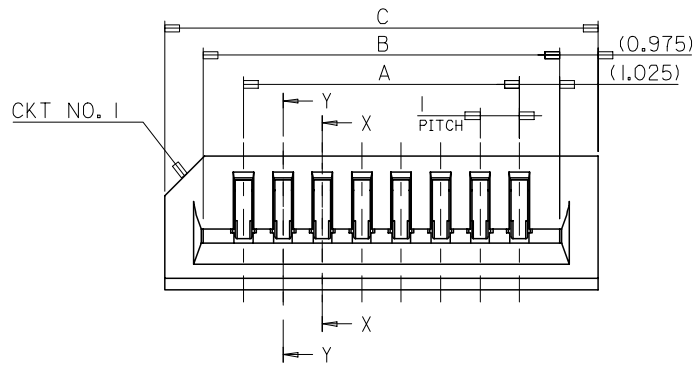

SECTION X-X
(ODD CKT)

SECTION Y-Y
(EVEN CKT)

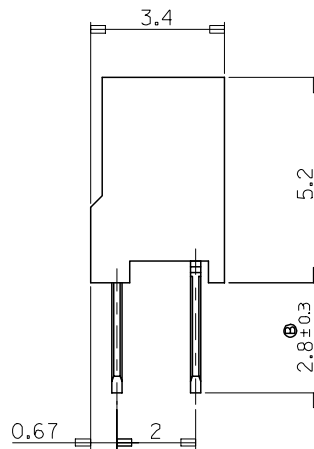
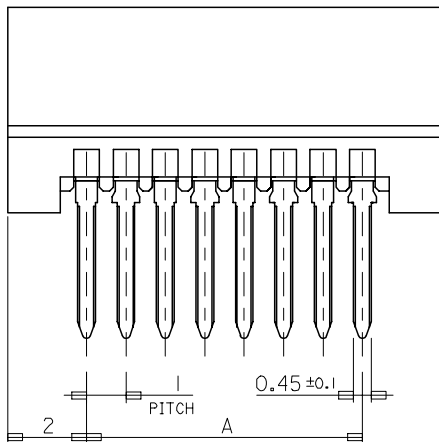

NOTES

- 1. MATERIAL
- HOUSING : NYLON66 (UL 94V-0)
(COLOR:BLACK)
- TERMINAL : PHOSPHOR BRONZE
TIN-PLATED

33	31.05	29	35857-3041	30
32	30.05	28	-2941	29
31	29.05	27	-2841	28
30	28.05	26	-2741	27
29	27.05	25	-2641	26
28	26.05	24	-2541	25
27	25.05	23	-2441	24
26	24.05	22	-2341	23
25	23.05	21	-2241	22
24	22.05	20	-2141	21
23	21.05	19	-2041	20
22	20.05	18	-1941	19
21	19.05	17	-1841	18
20	18.05	16	-1741	17
19	17.05	15	-1641	16
18	16.05	14	-1541	15
17	15.05	13	-1441	14
16	14.05	12	-1341	13
15	13.05	11	-1241	12
14	12.05	10	-1141	11
13	11.05	9	-1041	10
12	10.05	8	-0941	9
11	9.05	7	-0841	8
10	8.05	6	-0741	7
9	7.05	5	-0641	6
8	6.05	4	-0541	5
7	5.05	3	-0441	4
6	4.05	2	35857-0341	3
C	B	A	ENG. NO.	CKT. NO.

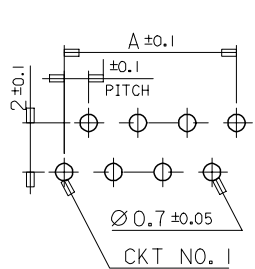

P.C. BOARD LAYOUT
(MOUNTING SIDE)
(THK. : 1.6+)

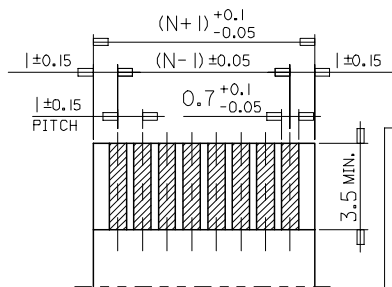

APPLICABLE FPC
(THK. : 0.3 ± 0.03)

ENTER DESCRIPTION
EC NO: KOR2007-0095
DRWN: JHLEE05 2007/02/23
CHKD: KSKIM 2007/02/23
APPR: YUNSIKKIM 2007/02/26

QUALITY SYMBOLS
▽=0
△=0

GENERAL TOLERANCES (UNLESS SPECIFIED)	
mm	INCH
4 PLACES ± ---	± ---
3 PLACES ± ---	± ---
2 PLACES ± ---	± ---
1 PLACE ± 0.2	± ---
ANGULAR ± 1 °	
DRAFT WHERE APPLICABLE MUST REMAIN WITHIN DIMENSIONS	

DIMENSION STYLE
IN/MM

DRAWN BY HS. SHIN DATE 1999/02/26
CHECKED BY JK. OH DATE 1999/02/26
APPROVED BY CW. LEE DATE 1999/02/26

MATERIAL NO.
ENTER PART

SIZE A3

SCALE 1:1

DESIGN UNITS METRIC

THIRD ANGLE PROJECTION

MOLEX

DOCUMENT NO. SD-35857-***41

1.0 FFC CONN.
NON-ZIF ST. SERIES
(03~30 CKTS)

MOLEX INCORPORATED

SHEET NO. 1 OF 00

THIS DRAWING CONTAINS INFORMATION THAT IS PROPRIETARY TO MOLEX INCORPORATED AND SHOULD NOT BE USED WITHOUT WRITTEN PERMISSION