

PLEASE CHECK WWW.MOLEX.COM FOR LATEST PART INFORMATION

Part Number: [0877590465](#)
Status: **Active**
Overview: milligrid
Description: 2.00mm (.079") Pitch Milli-Grid™ Header, Surface Mount, Vertical, 4 Circuits, 0.76µm (30µ") Gold (Au) Selective Plating, with Pick-and-Place Cap, Tube Packaging, without Press-fit Plastic Pegs, Lead-free

Documents:

[3D Model](#) [Product Specification PS-87761-100 \(PDF\)](#)
[Drawing \(PDF\)](#) [RoHS Certificate of Compliance \(PDF\)](#)

Agency Certification

UL E29179

General

Product Family PCB Headers
 Series [87759](#)
 Application Board-to-Board
 Overview [milligrid](#)
 Product Name Milli-Grid™

Physical

Breakaway Yes
 Circuits (Loaded) 4
 Circuits (maximum) 4
 Color - Resin Black
 Durability (mating cycles max) 100
 First Mate / Last Break No
 Flammability 94V-0
 Glow-Wire Compliant No
 Guide to Mating Part No
 Keying to Mating Part None
 Lock to Mating Part None
 Mated Height (in) 0.150 In
 Mated Height (mm) 3.80 mm
 Material - Metal Phosphor Bronze
 Material - Plating Mating Gold
 Material - Plating Termination Tin
 Material - Resin High Temperature Thermoplastic
 Number of Rows 2
 Orientation Vertical
 PCB Locator No
 PCB Retention None
 Packaging Type Tube
 Pitch - Mating Interface (in) 0.079 In
 Pitch - Mating Interface (mm) 2.00 mm
 Pitch - Term. Interface (in) 0.079 In
 Pitch - Term. Interface (mm) 2.00 mm
 Plating min: Mating (µin) 30
 Plating min: Mating (µm) 0.76
 Polarized to Mating Part No
 Polarized to PCB No
 Robotic Placement Pick and Place Cap
 Shrouded No
 Stackable Yes
 Temperature Range - Operating -55°C to +105°C

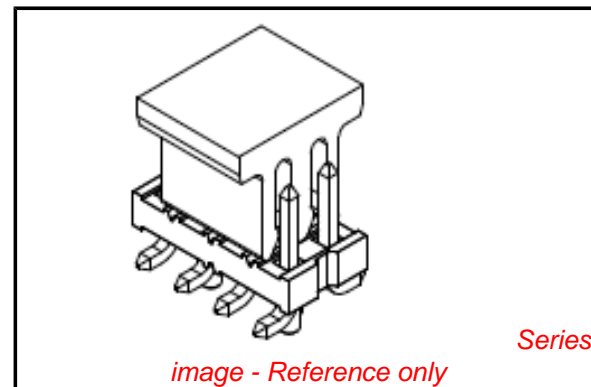

EU RoHS

ELV and RoHS Compliant
REACH SVHC
 Not Reviewed
Halogen-Free Status
Not Reviewed

China RoHS



Need more information on product environmental compliance?

Email productcompliance@molex.com
 For a multiple part number RoHS Certificate of Compliance, [click here](#)

Please visit the [Contact Us](#) section for any non-product compliance questions.

Search Parts in this Series

[87759Series](#)

Mates With

[79107](#) Milli-Grid™ Receptacle, Vertical, Through Hole. [79108](#) Milli-Grid™ Flex-to-Board, Vertical Receptacle. Milli-Grid™ Receptacle, Surface Mount. [79109](#). [87381](#)

Termination Interface: Style Surface Mount

Electrical

Current - Maximum per Contact 2A
Voltage - Maximum 125V

Solder Process Data

Duration at Max. Process Temperature (seconds) 10
Lead-free Process Capability Reflow Capable (SMT only)
Max. Cycles at Max. Process Temperature 3
Process Temperature max. C 260

Material Info

Reference - Drawing Numbers

Packaging Specification PK-89990-476
Product Specification PS-87761-100
Sales Drawing SD-87759-118

This document was generated on 05/25/2010

PLEASE CHECK WWW.MOLEX.COM FOR LATEST PART INFORMATION

10 9 8 7 6 5 4 3 2 1

F

E

D

C

B

A

F

E

D

C

B

A



NOTE:

1. MATERIAL:
HSG & CAP - LCP,
UL 94V-0, COLOUR BLACK
- PIN - 0.50 SQ PHOSPHOR BRONZE
2. PLATING:
0.76µm MIN GOLD PLATE AT CONTACT AREA,
TIN PLATE AT SOLDER AREA,
BOTH OVER NICKEL UNDERPLATE
3. PIN PUSHOUT FORCE: 1KG MIN IN EITHER DIRECTION
4. PRODUCT SPEC PS-87761-100 APPLIES.
5. BEND DEPRESSION IS ACCEPTABLE SO LONG AS IT DOES NOT AFFECT THE OVERALL COPLANARITY OF TAIL.
6. COPLANARITY IS TO BE MEASURED BY RESTING THE SOLDER TAIL ON A FLAT SURFACE.
7. CAP TO BE LOCATED AS CENTRAL OF PART AS POSSIBLE
TOP SURFACE OF CAP TO BE FLAT FOR THE PURPOSE OF PICK & PLACE BY VACUUM SUCTION NOZZLE.
8. FOR ILLUSTRATION PURPOSES, 12CKT IS SHOWN.
9. CKT 4 & 6 IS CUT FROM CKT 8 & 12 RESPECTIVELY
ROUGH EDGES ARE EXPECTED ALONG THE CUTTING EDGES.
10. PART TO BE PACKED IN TRAY 10 ONLY.
11. TUBE LENGTH IS 560MM REF STANDARD.

REVISED TUBE SPEC EC NO: S2007-0829 DRWNS:SKLIM01 CHKD:CLAM APPR:KWLEE	2007/04/10 2007/04/12 2007/04/17	DESCRIPTION REV	QUALITY SYMBOLS	GENERAL TOLERANCES (UNLESS SPECIFIED)		DIMENSION STYLE MM ONLY		SCALE NTS	DESIGN UNITS METRIC	THIRD ANGLE PROJECTION																				
			▽=0 ∇=0	<table border="1"> <thead> <tr> <th></th> <th>mm</th> <th>INCH</th> </tr> </thead> <tbody> <tr> <td>4 PLACES</td> <td>± ---</td> <td>± ---</td> </tr> <tr> <td>3 PLACES</td> <td>± ---</td> <td>± ---</td> </tr> <tr> <td>2 PLACES</td> <td>± 0.2</td> <td>± ---</td> </tr> <tr> <td>1 PLACE</td> <td>± ---</td> <td>± ---</td> </tr> <tr> <td colspan="3">ANGULAR ± 3 °</td> </tr> </tbody> </table>			mm	INCH	4 PLACES	± ---	± ---	3 PLACES	± ---	± ---	2 PLACES	± 0.2	± ---	1 PLACE	± ---	± ---	ANGULAR ± 3 °			DRAWN BY KSEE		DATE 2003/12/17	TITLE MGRID, 2MM DUAL ROW HEADER, SMT			
				mm	INCH																									
			4 PLACES	± ---	± ---																									
3 PLACES	± ---	± ---																												
2 PLACES	± 0.2	± ---																												
1 PLACE	± ---	± ---																												
ANGULAR ± 3 °																														
			CHECKED BY KCLING		DATE 2004/01/12	APPROVED BY SKTOH		DATE 2004/01/12	MOLEX INCORPORATED																					
			DRAFT WHERE APPLICABLE MUST REMAIN WITHIN DIMENSIONS		SEE TABLE		MATERIAL NO. DOCUMENT NO.		SHEET NO. 1 OF 4																					

9 8 7 6 5 4 3 2 1

10 9 8 7 6 5 4 3 2 1

F

E

D

C

B

A

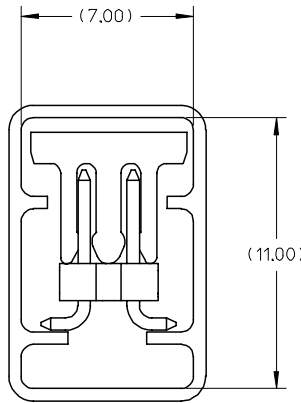
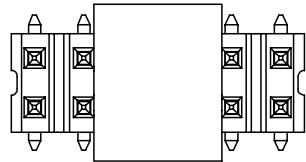
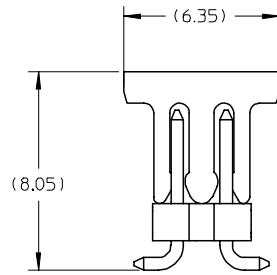
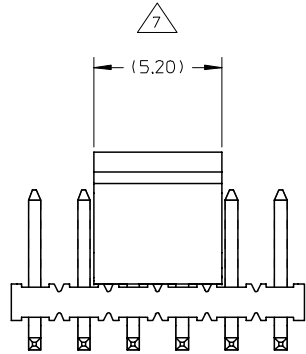

PART WITH CAP IN TUBE ORIENTATION

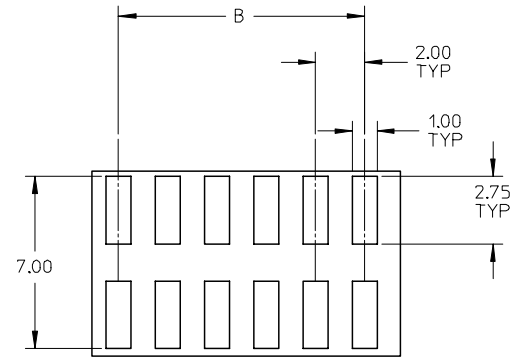

RECOMMENDED SOLDER PAD LAYOUT

REVISED TUBE SPEC	DESCRIPTION
EC NO: S2007-0829	2007/04/10
DRWN:SKL/M01	2007/04/12
CHKD:C/LAM	2007/04/17
APPR:K/LEE	
REV	REV

QUALITY SYMBOLS	DESCRIPTION
▽=0	
▽C=0	

GENERAL TOLERANCES (UNLESS SPECIFIED)		
	mm	INCH
4 PLACES	± .005	± .0004
3 PLACES	± .008	± .0003
2 PLACES	± 0.015	± .0006
1 PLACE	± .025	± .0010
ANGULAR ± 3°		
DRAFT WHERE APPLICABLE MUST REMAIN WITHIN DIMENSIONS		

DIMENSION STYLE		SCALE	DESIGN UNITS	THIRD ANGLE PROJECTION
MM ONLY		NTS	METRIC	
DRAWN BY	DATE	TITLE		
KSEE	2003/12/17	MGRID, 2MM DUAL ROW HEADER, SMT		
CHECKED BY	DATE			
KCLING	2004/01/12			
APPROVED BY	DATE			
SKTOH	2004/01/12			
MATERIAL NO.		DOCUMENT NO.	SHEET NO.	
		SD-87759-118	2 OF 4	
SIZE	THIS DRAWING CONTAINS INFORMATION THAT IS PROPRIETARY TO MOLEX INCORPORATED AND SHOULD NOT BE USED WITHOUT WRITTEN PERMISSION			
A3				

SCALE		DESIGN UNITS	THIRD ANGLE PROJECTION
NTS		METRIC	
DRAWN BY		DATE	TITLE
KSEE		2003/12/17	MGRID, 2MM DUAL ROW HEADER, SMT
CHECKED BY		DATE	
KCLING		2004/01/12	
APPROVED BY		DATE	
SKTOH		2004/01/12	
MATERIAL NO.		DOCUMENT NO.	SHEET NO.
		SD-87759-118	2 OF 4
SIZE	THIS DRAWING CONTAINS INFORMATION THAT IS PROPRIETARY TO MOLEX INCORPORATED AND SHOULD NOT BE USED WITHOUT WRITTEN PERMISSION		
A3			

9 8 7 6 5 4 3 2 1

EMBOSSED CARRIER TAPE TYPE "A"

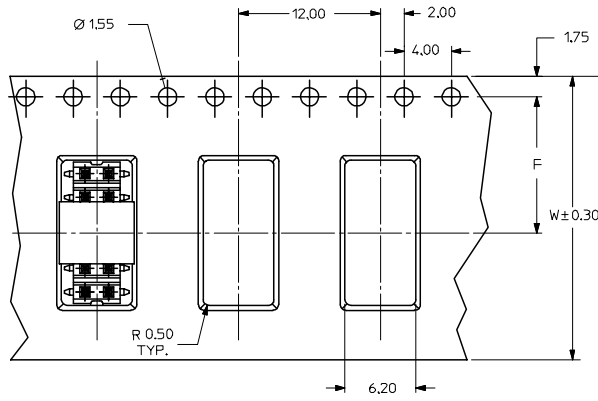

EMBOSSED CARRIER TAPE TYPE "C"

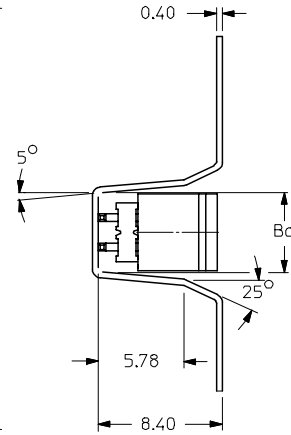

EMBOSSED CARRIER TAPE TYPE "B"

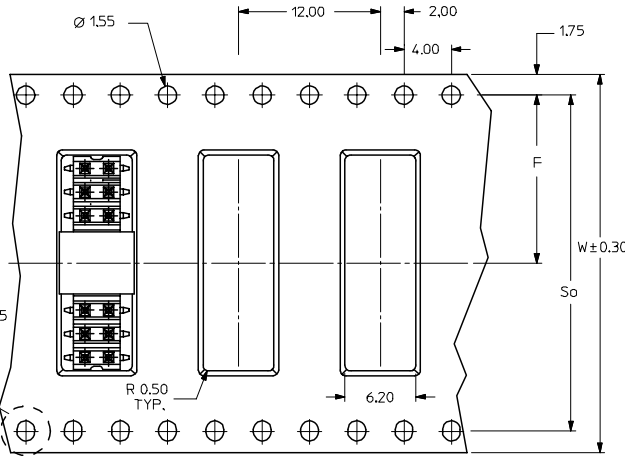
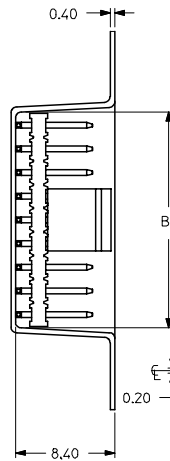

THIS TYPE OF CARRIER IS FOR CKT SIZE 8 AND BELOW.



REVISED TUBE SPEC	2007/04/10
EC NO: S2007-0829	2007/04/12
DRWN:SKL/M01	2007/04/12
CHKD:CLAM	2007/04/17
APPR:KWLEE	2007/04/17
REV	DESCRIPTION
B	



QUALITY SYMBOLS	▽=0
	▽C=0

GENERAL TOLERANCES (UNLESS SPECIFIED)	
	MM ONLY
	INCH
4 PLACES	± ---
3 PLACES	± ---
2 PLACES	± 0.2
1 PLACE	± ---
ANGULAR ± 3 °	
DRAFT WHERE APPLICABLE MUST REMAIN WITHIN DIMENSIONS	

DIMENSION STYLE	
MM ONLY	
DRAWN BY	DATE
KSEE	2003/12/17
CHECKED BY	DATE
KCLING	2004/01/12
APPROVED BY	DATE
SKTOH	2004/01/12
MATERIAL NO.	
SEE TABLE	
SIZE	A3

SCALE	DESIGN UNITS	THIRD ANGLE PROJECTION
NTS	METRIC	
TITLE		
MGRID, 2MM DUAL ROW HEADER, SMT		
MOLEX INCORPORATED		
DOCUMENT NO.	SHEET NO.	
SD-87759-118	3 OF 4	
THIS DRAWING CONTAINS INFORMATION THAT IS PROPRIETARY TO MOLEX INCORPORATED AND SHOULD NOT BE USED WITHOUT WRITTEN PERMISSION		

	10	9	8	7	6	5	4	3	2	1	
	PART NUMBER WITHOUT CAP IN TUBE	PART NUMBER WITH CAP IN TUBE	PART NUMBER WITH CAP IN TAPE AND REEL.	CKT SIZE	A	B	Bo	F	So	W	EMBOSSSED TYPE
F	87759-0415  	87759-0465	87759-0475	4	NA	2.00	5.40	11.50	-	24.00	C
	87759-0615 	87759-0665	87759-0675	6	NA	4.00	7.20	11.50	-	24.00	C
	87759-0815	87759-0865	87759-0875	8	7.90	6.00	8.20	11.50	-	24.00	C
	87759-1015	87759-1065	87759-1075	10	9.90	8.00	10.20	11.50	-	24.00	A
	87759-1215	87759-1265	87759-1275	12	11.90	10.00	12.20	11.50	-	24.00	A
E	87759-1415	87759-1465	87759-1475	14	13.90	12.00	14.20	11.50	-	24.00	A
	87759-1615	87759-1665	87759-1675	16	15.90	14.00	16.20	14.20	28.40	32.00	B
	87759-1815	87759-1865	87759-1875	18	17.90	16.00	18.20	14.20	28.40	32.00	B
	87759-2015	87759-2065	87759-2075	20	19.90	18.00	20.20	14.20	28.40	32.00	B
	87759-2215	87759-2265	87759-2275	22	21.90	20.00	22.20	20.20	40.40	44.00	B
	87759-2415	87759-2465	87759-2475	24	23.90	22.00	24.20	20.20	40.40	44.00	B
D	87759-2615	87759-2665	87759-2675	26	25.90	24.00	26.20	20.20	40.40	44.00	B
	87759-2815	87759-2865	87759-2875	28	27.90	26.00	28.20	20.20	40.40	44.00	B
	87759-3015	87759-3065	87759-3075	30	29.90	28.00	30.20	20.20	40.40	44.00	B
	87759-3215	87759-3265	87759-3275	32	31.90	30.00	32.20	20.20	40.40	44.00	B
	87759-3415	87759-3465	87759-3475	34	33.90	32.00	34.20	26.20	52.40	56.00	B
	87759-3615	87759-3665	87759-3675	36	35.90	34.00	36.20	26.20	52.40	56.00	B
	87759-3815	87759-3865	87759-3875	38	37.90	36.00	38.20	26.20	52.40	56.00	B
C	87759-4015	87759-4065	87759-4075	40	39.90	38.00	40.20	26.20	52.40	56.00	B
	87759-4215	87759-4265	87759-4275	42	41.90	40.00	42.20	26.20	52.40	56.00	B
	87759-4415	87759-4465	87759-4475	44	43.90	42.00	44.20	26.20	52.40	56.00	B
	87759-4615	87759-4665	87759-4675	46	45.90	44.00	46.20	26.20	52.40	56.00	B
	87759-4815	87759-4865	87759-4875	48	47.90	46.00	48.20	26.20	52.40	56.00	B
B	87759-5015	87759-5065	87759-5075	50	49.90	48.00	50.20	34.20	68.40	72.00	B

REVISED TUBE SPEC EC NO: S2007-0829 DRWNS:KLI M01 2007/04/10 CHKD:CWAM 2007/04/12 APPR:KWLEE 2007/04/17	DESCRIPTION REV	QUALITY SYMBOLS	GENERAL TOLERANCES (UNLESS SPECIFIED)	DIMENSION STYLE	SCALE	DESIGN UNITS	THIRD ANGLE PROJECTION																
		$\nabla = 0$ $\nabla \square = 0$	<table border="1"> <tr> <th></th> <th>mm</th> <th>INCH</th> </tr> <tr> <td>4 PLACES</td> <td>± ---</td> <td>± ---</td> </tr> <tr> <td>3 PLACES</td> <td>± ---</td> <td>± ---</td> </tr> <tr> <td>2 PLACES</td> <td>± 0.2</td> <td>± ---</td> </tr> <tr> <td>1 PLACE</td> <td>± ---</td> <td>± ---</td> </tr> </table>		mm	INCH	4 PLACES	± ---	± ---	3 PLACES	± ---	± ---	2 PLACES	± 0.2	± ---	1 PLACE	± ---	± ---	MM ONLY	NTS	METRIC		
			mm	INCH																			
		4 PLACES	± ---	± ---																			
3 PLACES	± ---	± ---																					
2 PLACES	± 0.2	± ---																					
1 PLACE	± ---	± ---																					
	<table border="1"> <tr> <td>DRAWN BY</td> <td>DATE</td> <td>TITLE</td> </tr> <tr> <td>KSEE</td> <td>2003/12/17</td> <td>MGRID, 2MM DUAL ROW HEADER, SMT</td> </tr> <tr> <td>CHECKED BY</td> <td>DATE</td> <td></td> </tr> <tr> <td>KCLING</td> <td>2004/01/12</td> <td></td> </tr> <tr> <td>APPROVED BY</td> <td>DATE</td> <td></td> </tr> <tr> <td>SKTOH</td> <td>2004/01/12</td> <td></td> </tr> </table>	DRAWN BY	DATE	TITLE	KSEE	2003/12/17	MGRID, 2MM DUAL ROW HEADER, SMT	CHECKED BY	DATE		KCLING	2004/01/12		APPROVED BY	DATE		SKTOH	2004/01/12					 MOLEX INCORPORATED
DRAWN BY	DATE	TITLE																					
KSEE	2003/12/17	MGRID, 2MM DUAL ROW HEADER, SMT																					
CHECKED BY	DATE																						
KCLING	2004/01/12																						
APPROVED BY	DATE																						
SKTOH	2004/01/12																						
		DRAFT WHERE APPLICABLE MUST REMAIN WITHIN DIMENSIONS	SEE TABLE			DOCUMENT NO. SD-87759-118	SHEET NO. 4 OF 4																