



MICROWAVE CORPORATION v00.0407



HMC512LP5 / 512LP5E

MMIC VCO w/ HALF FREQUENCY OUTPUT & DIVIDE-BY-4, 9.6 - 10.8 GHz

Typical Applications

Low noise MMIC VCO w/Half Frequency, Divide-by-4 Outputs for:

- Point to Point/Multipoint Radio
- Test Equipment & Industrial Controls
- SATCOM
- Military End-Use

Features

Triple Output: $F_o = 9.6 - 10.8$ GHz
 $F_o/2 = 4.8 - 5.4$ GHz
 $F_o/4 = 2.4 - 2.7$ GHz

Pout: +9 dBm

Phase Noise: -110 dBc/Hz @100 kHz Typ.

No External Resonator Needed

QFN Leadless SMT Package, 25 mm²

Functional Diagram

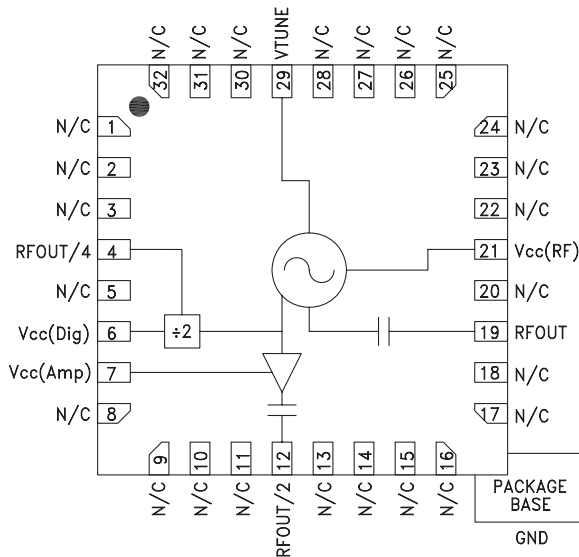

General Description

The HMC512LP5 & HMC512LP5E are GaAs InGaP Heterojunction Bipolar Transistor (HBT) MMIC VCOs. The HMC512LP5 & HMC512LP5E integrate resonators, negative resistance devices, varactor diodes and feature half frequency and divide-by-4 outputs. The VCO's phase noise performance is excellent over temperature, shock, and process due to the oscillator's monolithic structure. Power output is +9 dBm typical from a +5V supply voltage. The prescaler and RF/2 functions can be disabled to conserve current if not required. The voltage controlled oscillator is packaged in a leadless QFN 5x5 mm surface mount package, and requires no external matching components.

Electrical Specifications, $T_A = +25^\circ C$, $V_{cc} (Dig)$, $V_{cc} (Amp)$, $V_{cc} (RF) = +5V$

Parameter	Min.	Typ.	Max.	Units	
Frequency Range	F_o $F_o/2$	9.6 - 10.8 4.8 - 5.4		GHz GHz	
Power Output	RFOUT RFOUT/2 RFOUT/4	+3 +6 -8	+15 +14 -3	dBm dBm dBm	
SSB Phase Noise @ 100 kHz Offset, Vtune= +5V @ RFOUT		-110		dBc/Hz	
Tune Voltage	Vtune	2	13	V	
Supply Current	$I_{cc}(Dig) + I_{cc}(Amp) + I_{cc}(RF)$	250	330	370	mA
Tune Port Leakage Current (Vtune= 12V)			10	μA	
Output Return Loss		3		dB	
Harmonics/Subharmonics	1/2 2nd 3rd	33 25 35		dBc dBc dBc	
Pulling (into a 2.0:1 VSWR)		5		MHz pp	
Pushing @ Vtune= 5V		30		MHz/V	
Frequency Drift Rate		1.2		MHz/ $^\circ C$	

For price, delivery, and to place orders, please contact Hittite Microwave Corporation:
 20 Alpha Road, Chelmsford, MA 01824 Phone: 978-250-3343 Fax: 978-250-3373
 Order On-line at www.hittite.com



HMC512LP5 / 512LP5E

**MMIC VCO w/ HALF FREQUENCY OUTPUT
& DIVIDE-BY-4, 9.6 - 10.8 GHz**

Frequency vs. Tuning Voltage, Vcc = +5V

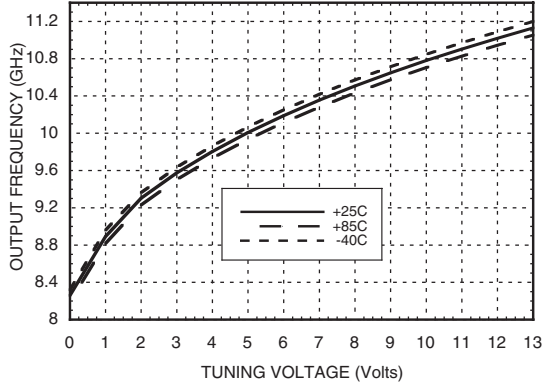

Frequency vs. Tuning Voltage, T = 25°C

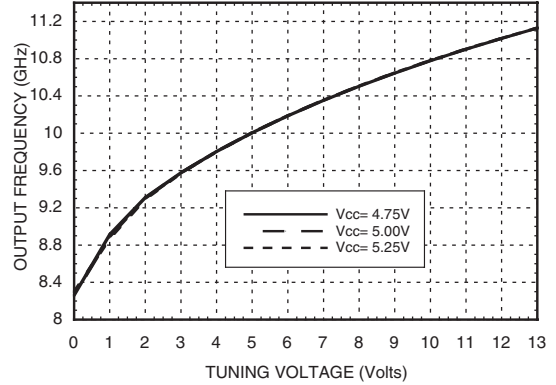

Sensitivity vs. Tuning Voltage, Vcc = +5V

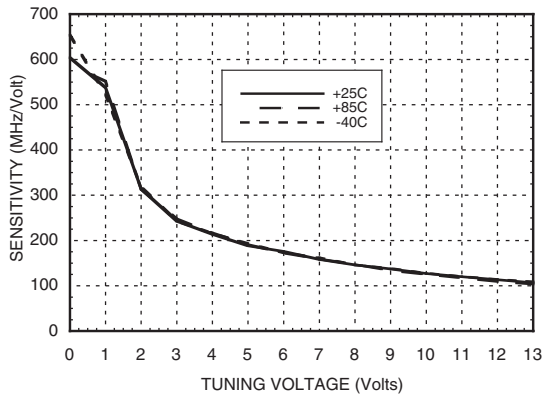

Output Power vs. Tuning Voltage, Vcc = +5V

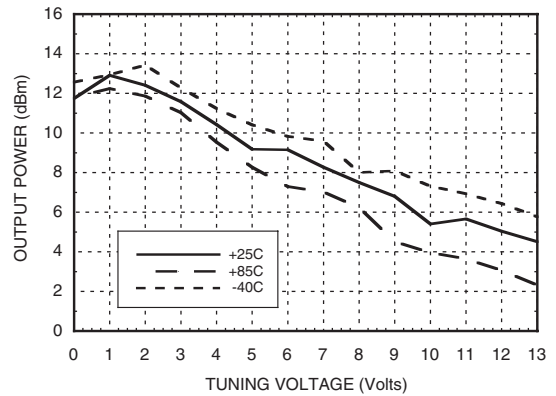

SSB Phase Noise vs. Tuning Voltage

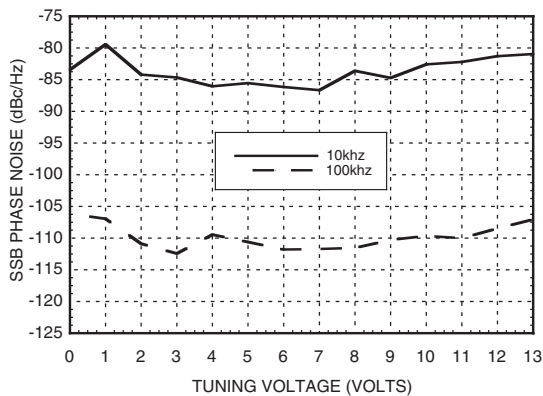

SSB Phase Noise @ Vtune = +5V

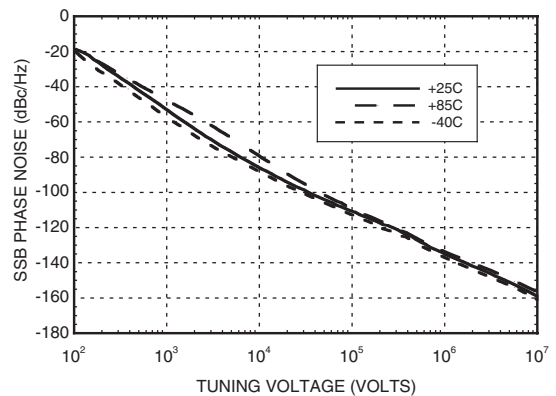



HMC512LP5 / 512LP5E

**MMIC VCO w/ HALF FREQUENCY OUTPUT
& DIVIDE-BY-4, 9.6 - 10.8 GHz**

**RFOUT/2 Frequency
vs. Tuning Voltage, Vcc = +5V**

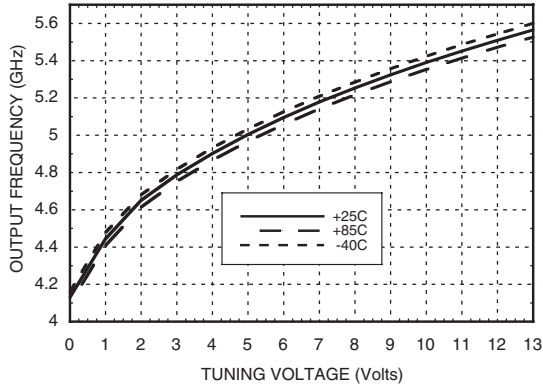

**RFOUT/2 Output Power
vs. Tuning Voltage, Vcc = +5V**

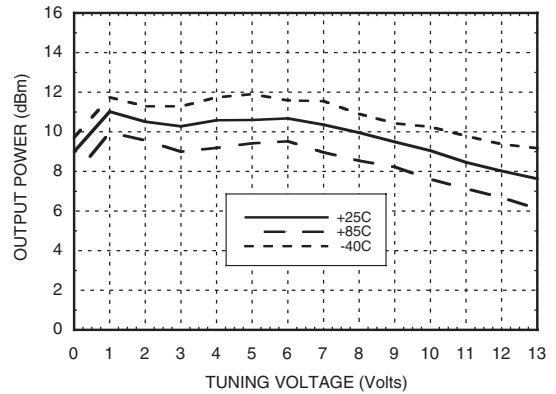

**Divide-by-4 Frequency
vs. Tuning Voltage, Vcc = +5V**

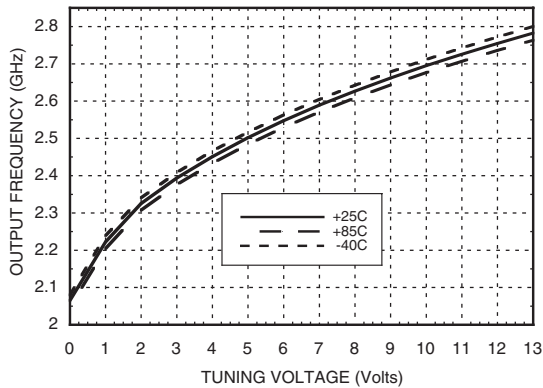

**Divide-by-4 Output Power
vs. Tuning Voltage, Vcc = +5V**

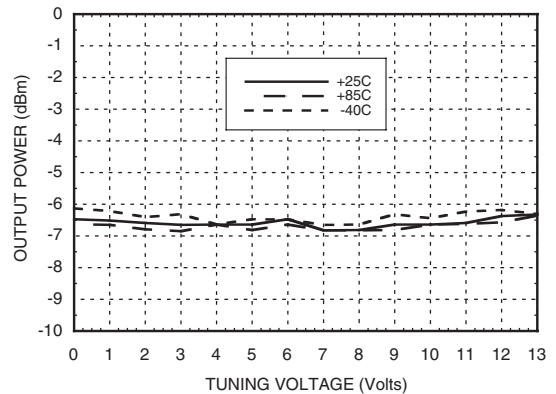



MICROWAVE CORPORATION v00.0407



HMC512LP5 / 512LP5E

MMIC VCO w/ HALF FREQUENCY OUTPUT & DIVIDE-BY-4, 9.6 - 10.8 GHz

Absolute Maximum Ratings

Vcc(Dig), Vcc(Amp), Vcc(RF)	+5.5 Vdc
Vtune	0 to +15V
Junction Temperature	135 °C
Continuous Pdiss (T=85 °C) (derate 43.5 mW/C above 85 °C)	2.17 W
Thermal Resistance (junction to ground paddle)	23 °C/W
Storage Temperature	-65 to +150 °C
Operating Temperature	-40 to +85 °C
ESD Sensitivity (HBM)	Class 1A

Typical Supply Current vs. Vcc

Vcc (V)	Icc (mA)
4.75	300
5.00	330
5.25	360

Note: VCO will operate over full voltage range shown above.



ELECTROSTATIC SENSITIVE DEVICE
OBSERVE HANDLING PRECAUTIONS

Outline Drawing

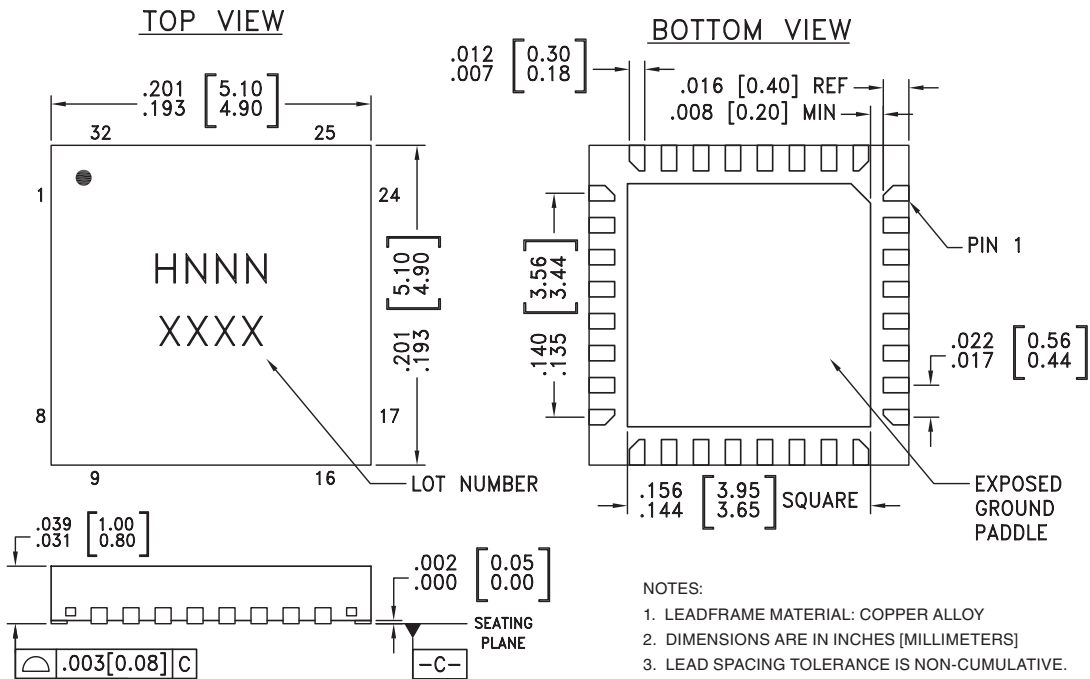

Package Information

Part Number	Package Body Material	Lead Finish	MSL Rating	Package Marking ^[3]
HMC512LP5	Low Stress Injection Molded Plastic	Sn/Pb Solder	MSL1 ^[1]	H512 XXXX
HMC512LP5E	RoHS-compliant Low Stress Injection Molded Plastic	100% matte Sn	MSL1 ^[2]	H512 XXXX

[1] Max peak reflow temperature of 235 °C

[2] Max peak reflow temperature of 260 °C



[3] 4-Digit lot number XXXX

For price, delivery, and to place orders, please contact Hittite Microwave Corporation:
20 Alpha Road, Chelmsford, MA 01824 Phone: 978-250-3343 Fax: 978-250-3373
Order On-line at www.hittite.com

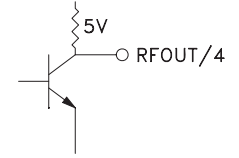
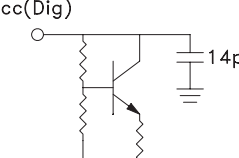
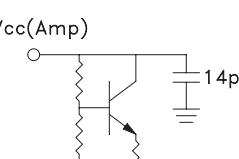
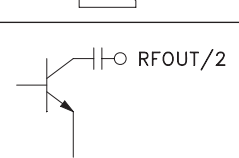
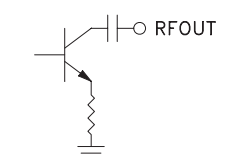
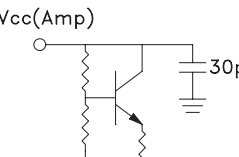
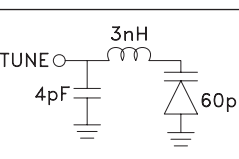

**MMIC VCO w/ HALF FREQUENCY OUTPUT
& DIVIDE-BY-4, 9.6 - 10.8 GHz**

Pin Descriptions

Pin Number	Function	Description	Interface Schematic
1-3, 5, 8-11, 13-18, 20, 22-28, 30-32	N/C	No Connection. These pins may be connected to RF/DC ground. Performance will not be affected.	
4	RFOUT/4	Divide-by-4 output. DC block required.	
6	Vcc (Dig)	Supply voltage for prescaler. If prescaler is not required, this pin may be left open to conserve approximately 65 mA of current.	
7	Vcc (Amp)	Supply voltage for RFOUT/2 output. If RFOUT/2 is not required, this pin may be left open to conserve approximately 30 mA of current.	
12	RFOUT/2	Half frequency output (AC coupled).	
19	RF OUT	RF output (AC coupled).	
21	Vcc (RF)	Supply Voltage, +5V	
29	VTUNE	Control voltage and modulation input. Modulation bandwidth dependent on drive source impedance. See "Determining the FM Bandwidth of a Wideband Varactor Tuned VCO" application note.	
	GND	Package bottom has an exposed metal paddle that must be connected to RF/DC ground.	

Evaluation PCB

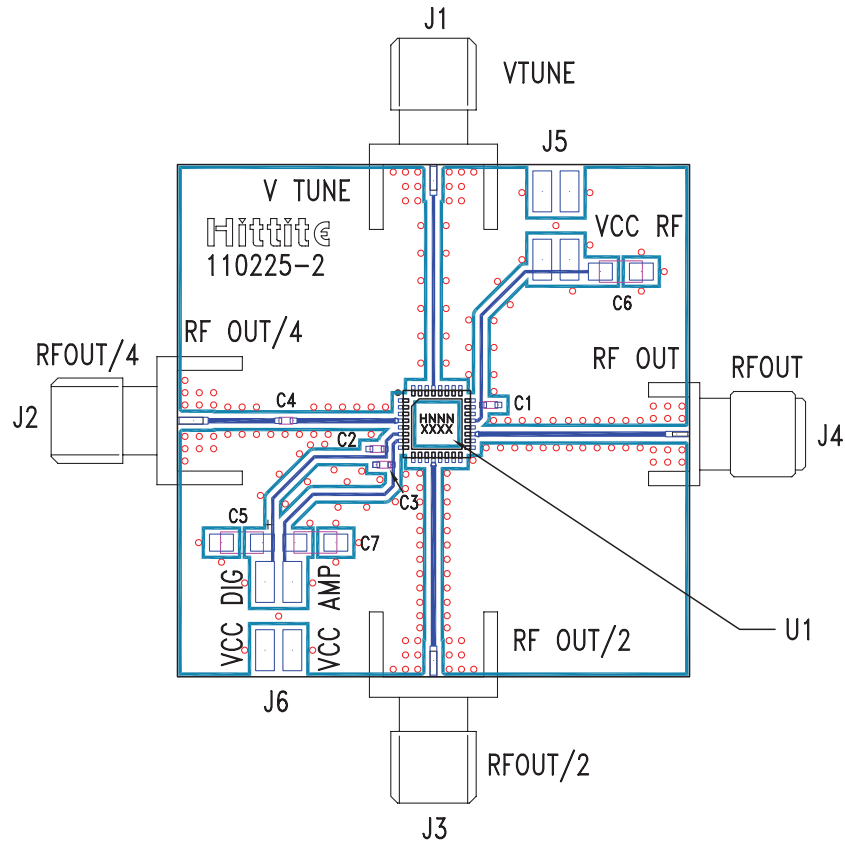

List of Materials for Evaluation PCB 110227 [1]

Item	Description
J1 - J4	PCB Mount SMA RF Connector
J5 - J6	2 mm DC Header
C1 - C3	100 pF Capacitor, 0402 Pkg.
C4	1,000 pF Capacitor, 0402 Pkg.
C5 - C7	2.2 μ F Tantalum Capacitor
U1	HMC512LP5 / HMC512LP5E VCO
PCB [2]	110225 Eval Board

[1] Reference this number when ordering complete evaluation PCB

[2] Circuit Board Material: Rogers 4350

The circuit board used in the final application should use RF circuit design techniques. Signal lines should have 50 ohm impedance while the package ground leads and backside ground paddle should be connected directly to the ground plane similar to that shown. A sufficient number of via holes should be used to connect the top and bottom ground planes. The evaluation circuit board shown is available from Hittite upon request.



MICROWAVE CORPORATION v00.0407



HMC512LP5 / 512LP5E

MMIC VCO w/ HALF FREQUENCY OUTPUT & DIVIDE-BY-4, 9.6 - 10.8 GHz

Typical Application Circuit

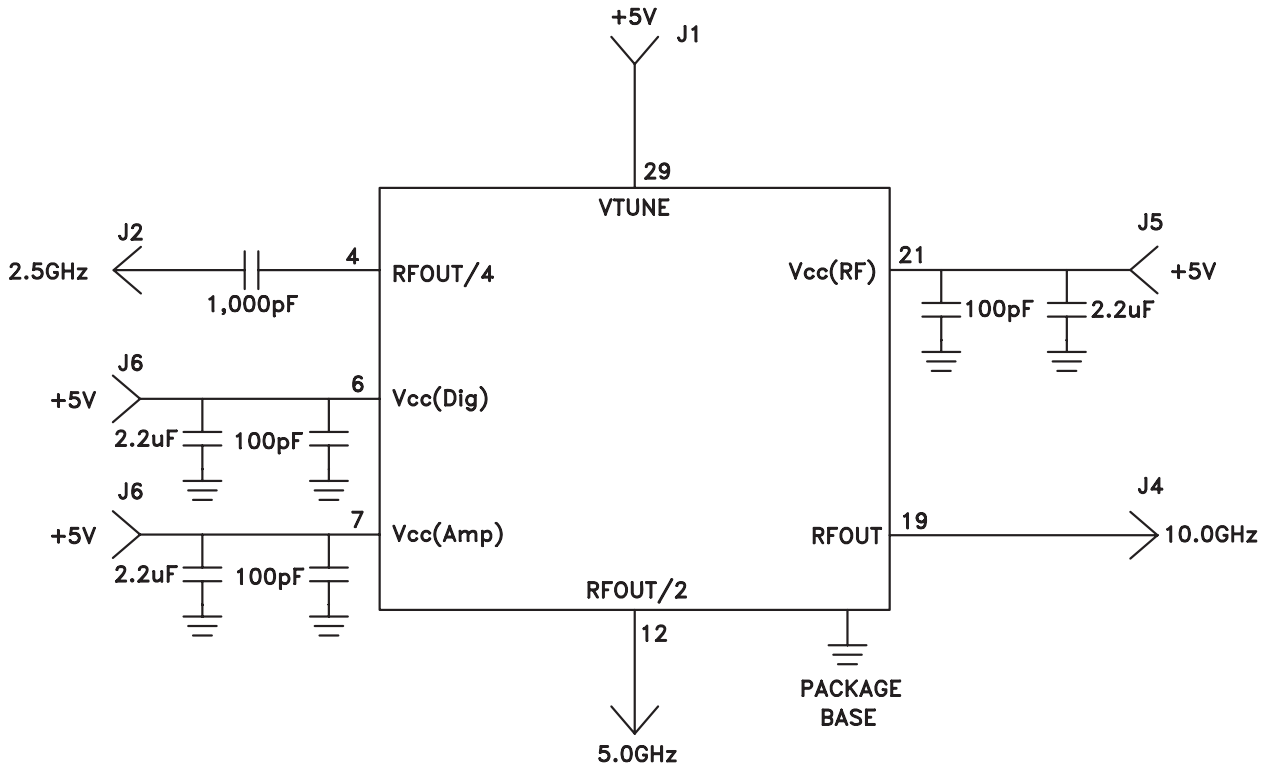

10

VCOs & PLOs - SMT



v00.0407

HMC512LP5 / 512LP5E

**MMIC VCO w/ HALF FREQUENCY OUTPUT
& DIVIDE-BY-4, 9.6 - 10.8 GHz**

Notes: