

# M52327SP

## WIDEBAND 3-CHANNEL VIDEO AMPLIFIER

### DESCRIPTION

M52327SP semiconductor integrated circuit is a wideband video amplifier. Its family products include M51392P, M51399P and M51387P. This IC has a 100 MHz band and 3 built-in channels. Each channel is provided with a wideband amplifier, contrast controls (main and sub), and brightness controls (main and sub). This IC is optimal for high-resolution color displays.

### FEATURES

- Produced by a new bipolar wafer processing method, this IC has 3 built-in channels, and operates with low power dissipation. ( $V_{cc}=12V$ ,  $I_{cc}=63mA$ )
- Input: 0.7VP-P(typ)  
Output: 4.5VP-P(max)  
Frequency band: 100 MHz(3VP-P)
- Contrast and brightness can be controlled with a main control and sub control. The main control changes contrast or brightness of 3 channels simultaneously. The sub control changes contrast or brightness of each channel independently.
- This IC has a built-in feedback circuit, ensuring stable DC output from IC output pin.

### APPLICATION

Cathode-ray tube displays

### PIN CONFIGURATION (TOP VIEW)

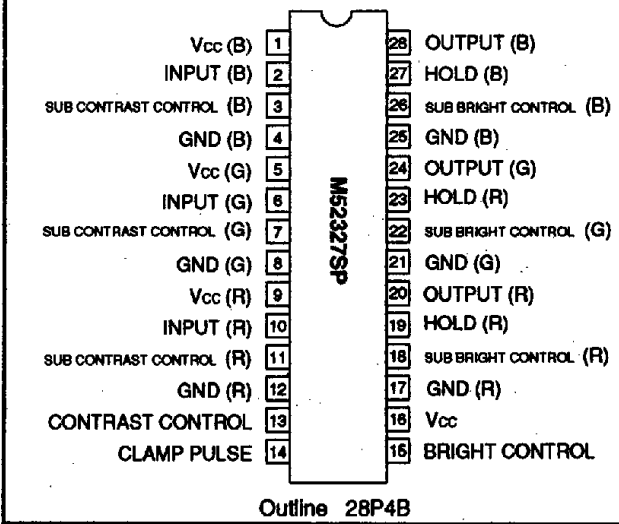

### RECOMMENDED OPERATING CONDITION

Supply voltage range	11.5~12.5V
Rated supply voltage	12.0V

DataSheet4U.com

DataShee

### BLOCK DIAGRAM

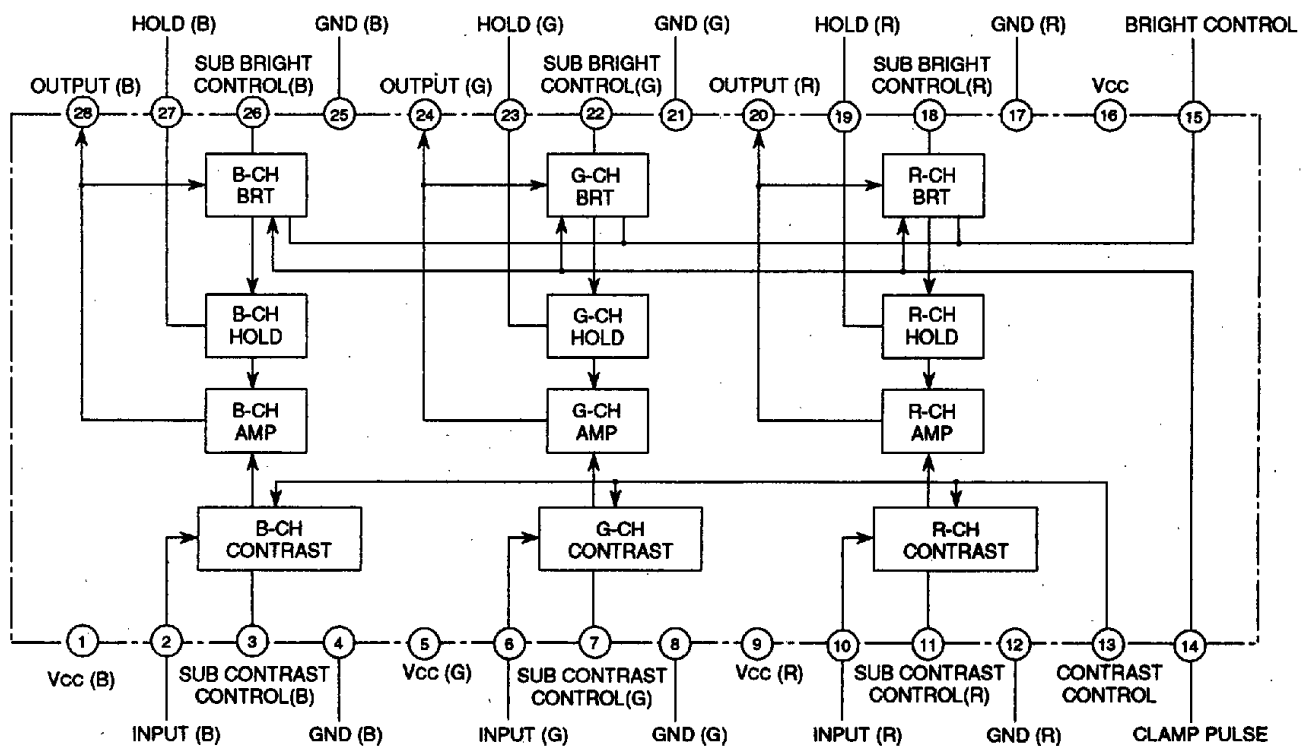

## WIDEBAND 3-CHANNEL VIDEO AMPLIFIER

## ABSOLUTE MAXIMUM RATINGS

Symbol	Parameter	Ratings	Unit
Vcc	Supply voltage	13.0	V
Pd	Power dissipation	1580	mW
Topr	Operating temperature	-20~+85	°C
Tstg	Storage temperature	-40~+150	°C
Vopr	Recommended operating supply voltage	12.0	V
Vopr	Recommended operating supply voltage range	11.5~12.5	V
Surge	Electrostatic discharge	±200	V

## ELECTRICAL CHARACTERISTICS (Ta=25°C, Vcc=12V, unless otherwise noted.)

Symbol	Parameter	Test point	Input			External Supply(V)				Pulse input	Limits			Unit
			SW10 R-ch	SW6 G-ch	SW2 B-ch	V3	V13	V15	V26		SW14	Min.	Typ.	
Icc	Circuit current	A	a —	a —	a —	12.0	12.0	5.0	—	b SG6	45	72	110	mA
Vomax	Output dynamic range	T.P20 T.P24 T.P28	b SG1	b SG1	b SG1	12.0	12.0	Variable	—	a —	5.8	6.8	9.0	Vp-p
Vimax	Maximum allowable input	T.P20 T.P24 T.P28	b SG1	b SG1	b SG1	12.0	6.0	Variable	—	a —	1.9	2.4	2.9	Vp-p
Gv	Maximum gain	T.P20 T.P24 T.P28	b SG1	b SG1	b SG1	12.0	12.0	VT	—	a —	13.0	17.0	20.0	dB
ΔGv	Relative maximum gain		Relative values to the measurements above								0.8	1.0	1.2	—
VCR1	Contrast control characteristic (typ)	T.P20 T.P24 T.P28	b SG1	b SG1	b SG1	12.0	6.0	VT	—	a —	4.0	7.4	10.1	dB
ΔVCR1	Relative contrast control characteristic (typ)		Relative values to the measurements above								0.8	1.0	1.2	—
VCR2	Contrast control characteristic (min)	T.P20 T.P24 T.P28	b SG1	b SG1	b SG1	12.0	3.5	VT	—	a —	5	30.0	70.0	mVp-p
ΔVCR2	Relative contrast control characteristic (min)		Relative values to the measurements above								0.8	1.0	1.3	—
VSCR1	Sub contrast control characteristic (typ)	T.P20 T.P24 T.P28	b SG1	b SG1	b SG1	6.0	12.0	VT	—	a —	9.9	14.0	18.1	dB
ΔVSCR1	Relative sub contrast control characteristic (typ)		Relative values to the measurements above								0.8	1.0	1.2	—
VSCR2	Sub contrast control characteristic (min)	T.P20 T.P24 T.P28	b SG1	b SG1	b SG1	3.0	12.0	VT	—	a —	100.0	300.0	860.0	mVp-p
ΔVSCR2	Relative sub contrast control characteristic (min)		Relative values to the measurements above								0.8	1.0	1.2	—
VCR3	Contrast/Sub contrast control characteristic (typ)	T.P20 T.P24 T.P28	b SG1	b SG1	b SG1	6.0	6.0	VT	—	a —	900	1300	1700	mVp-p
ΔVCR3	Relative contrast/sub contrast control characteristic (typ)		Relative values to the measurements above								0.8	1.0	1.2	—

## WIDEBAND 3-CHANNEL VIDEO AMPLIFIER

## ELECTRICAL CHARACTERISTICS (cont.)

Symbol	Parameter	Test point	Input			External Supply (v)				Pulse input SW14	Limits			Unit
			SW10 R-ch	SW6 G-ch	SW B-ch	V3	V13	V15	V26		Min.	Typ.	Max.	
VB1	Brightness control characteristic (max)	T.P20 T.P24 T.P28	a —	a —	a —	12.0	12.0	5.5	—	b SG6	3.6	4.3	5.0	V
$\Delta$ VB1	Relative brightness control characteristic (max)		Relative values to the measurements above								-100	0.0	100.0	mV
VB2	Brightness control characteristic (typ)	T.P20 T.P24 T.P28	a —	a —	a —	12.0	12.0	5.0	—	b SG6	3.0	3.7	4.4	V
$\Delta$ VB2	Relative brightness control characteristic (typ)		Relative values to the measurements above								-100	0.0	100.0	mV
VB3	Brightness control characteristic (min)	T.P20 T.P24 T.P28	a —	a —	a —	12.0	12.0	4.5	—	b SG6	2.5	3.2	4.0	Vdc
$\Delta$ VB3	Relative brightness control characteristic (min)		Relative values to the measurements above								-100	0.0	100.0	mV
VSB1	Sub brightness control characteristic (max)	T.P20 T.P24 T.P28	a —	a —	a —	12.0	12.0	5.0	4.0	b SG6	2.3	3.1	3.9	Vdc
VSB2	Sub brightness control characteristic (min)	T.P20 T.P24 T.P28	a —	a —	a —	12.0	12.0	5.0	3.5	b SG6	2.2	3.0	3.8	Vdc
Fc1	Frequency characteristic I (f=50MHz,maximum)	T.P20 T.P24 T.P28	b SG3	b SG3	b SG3	12.0	7.5	V <sub>T</sub>	—	a —	-2	-1	3	dB
$\Delta$ Fc1	Relative frequency characteristic I (f=50MHz,maximum)		Relative values to the measurements above								-1.0	0.0	1.0	dB
Fc1'	Frequency characteristic I (f=100MHz,maximum)	T.P20 T.P24 T.P28	b SG4	b SG4	b SG4	12.0	7.5	V <sub>T</sub>	—	a —	-3	-2	3	dB
$\Delta$ Fc1'	Relative frequency characteristic I (f=100MHz,maximum)		Relative values to the measurements above								-1.0	0.0	1.0	dB
Fc2	Frequency characteristic II (f=50MHz,maximum)	T.P20 T.P24 T.P28	b SG3	b SG3	b SG3	12.0	6.5	V <sub>T</sub>	—	a —	-1	0	3	dB
Fc2'	Frequency characteristic II (f=100MHz,maximum)	T.P20 T.P24 T.P28	b SG4	b SG4	b SG4	12.0	6.5	V <sub>T</sub>	—	a —	-2.5	0	3	dB
Fc5	Frequency characteristic III (f=50MHz,maximum)	T.P20 T.P24 T.P28	b SG3	b SG3	b SG3	12.0	5.0	V <sub>T</sub>	—	a —	-0.5	0	2	dB
Fc5'	Frequency characteristic III (f=100MHz,maximum)	T.P20 T.P24 T.P28	b SG4	b SG4	b SG4	12.0	5.0	V <sub>T</sub>	—	a —	-0.5	0	2	dB
C.T.1	Cross talk I (f=50MHz)	T.P20 T.P24 T.P28	b SG3	a —	a —	12.0	12.0	V <sub>T</sub>	—	a —	—	-32	-20	dB
C.T.1'	Cross talk I (f=100MHz)	T.P20 T.P24 T.P28	b SG4	a —	a —	12.0	12.0	V <sub>T</sub>	—	a —	—	-22	-15	dB
C.T.2	Cross talk II (f=50MHz)	T.P20 T.P24 T.P28	a —	b SG3	a —	12.0	12.0	V <sub>T</sub>	—	a —	—	-32	-20	dB
C.T.2'	Cross talk II (f=100MHz)	T.P20 T.P24 T.P28	a —	b SG4	a —	12.0	12.0	V <sub>T</sub>	—	a —	—	-22	-15	dB

## WIDEBAND 3-CHANNEL VIDEO AMPLIFIER

## ELECTRICAL CHARACTERISTICS (cont.)

Symbol	Parameter	Test point	Input			External Supply (v)				Pulse input	Limits			Unit
			SW10 R-ch	SW6 G-ch	SW2 B-ch	V3	V13	V15	V26	SW14	Min.	Typ.	Max.	
C.T.3	Cross talk III (f=50MHz)	T.P20 T.P24 T.P28	a —	a —	b SG3	12.0	12.0	V <sub>T</sub>	—	a —	—	-32	-20	dB
C.T.3'	Cross talk III (f=100MHz)	T.P20 T.P24 T.P28	a —	a —	b SG4	12.0	12.0	V <sub>T</sub>	—	a —	—	-22	-15	dB
Tr	Pulse characteristic I	T.P20 T.P24 T.P28	b SG5	b SG5	b SG5	12.0	7.0	3.0	—	b SG6	—	2	6	nsec
Tf	Pulse characteristic II	T.P20 T.P24 T.P28	b SG5	b SG5	b SG5	12.0	7.0	3.0	—	b SG6	—	5	8	nsec
V <sub>14th</sub>	Clamp pulse threshold voltage	T.P20 T.P24 T.P28	a —	a —	a —	12.0	12.0	3.0	—	b SG6	0.7	1.5	2.5	V <sub>DC</sub>
W <sub>14</sub>	Clamp pulse operating minimum width	T.P20 T.P24 T.P28	a —	a —	a —	12.0	12.0	3.0	—	b SG6	—	0.3	1.5	μsec
V <sub>27</sub>	Hold voltage	T.P20 T.P24 T.P28	a —	a —	a —	12.0	12.0	3.0	—	b SG6	4.0	5.2	6.4	V <sub>DC</sub>

Note 1. Only external power supply switch numbers will be mentioned in the electrical characteristic testing procedure described below, because the signal input pin switch numbers and pulse input pin switch numbers are specified in the electrical characteristic table.  
2. Sub brightness voltages V18, V22, V26 are always set to the same level, and V26 represents the other two in the electrical characteristic table. Sub contrast voltages V3, V7, V11 are also always set to the same level, therefore V3 represents the other two in the table.

## ELECTRICAL CHARACTERISTIC TEST METHOD

I<sub>CC</sub>

- Set SW18, SW22, SW26 to "b."
- Set other conditions as specified in the electrical characteristic table. Set SW1 to "a" and measure current with ammeter A.

V<sub>O</sub> max

- Set SW18, SW22, SW26 to "b."
- Set V15 in the following procedure.
  - Input SG1 to pin ⑩ (pin ⑥, pin ②). Increase V15 gradually, and read V15 when T.P20(T.P24, T.P28) output waveform peak distortion starts. This voltage is referred to as V<sub>TR1</sub>(V<sub>TG1</sub>, V<sub>TB1</sub>).  
Next, decrease V15 gradually, and read V15 when T.P20(T.P24, T.P28) output waveform pedestal distortion starts. This voltage is referred to as V<sub>TR2</sub>(V<sub>TG2</sub>, V<sub>TB2</sub>).

b) V<sub>T</sub> (V<sub>TR</sub>, V<sub>TG</sub>, V<sub>TB</sub>) can be calculated with the measured voltages, as follows:

$$V_{TR} (V_{TG}, V_{TB}) = \frac{V_{TR1}(V_{TG1}, V_{TB1}) + V_{TR2}(V_{TG1}, V_{TB1})}{2}$$

Use adequate voltages according to the output pin:250

T.P20 output is tested → V<sub>TR1</sub>

T.P24 output is tested → V<sub>TG1</sub>

T.P28 output is tested → V<sub>TB</sub>

- After setting V<sub>TR</sub> (V<sub>TG</sub>, V<sub>TB</sub>), increase SG1 amplitude gradually starting from 700mV, and read output amplitude when T.P20(T.P24, T.P28) output waveform peak and pedestal distortion starts.

V<sub>I</sub> max

Starting from a V<sub>O</sub> max state, change V13 to 6.0 V as specified in the electrical characteristic table. Increase input signal amplitude gradually, starting from 700 mV<sub>P-P</sub>, and read input signal amplitude when output signal distortion starts.

G<sub>v</sub> and ΔG<sub>v</sub>

- SW18, SW22, SW26 are all set to "b." Other conditions are as specified in the electric characteristic table.
- Input SG1 to pin ⑩ (pin ⑥, pin ②), and read output amplitude of T.P20 (T.P24, T.P28). The amplitude is referred to as V<sub>OR1</sub> (V<sub>OG1</sub> or V<sub>OB1</sub>).

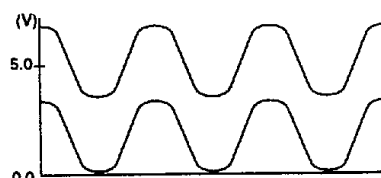

T.P20 Output Waveform (T.P24 and T.P28 waveforms are the same.)

## WIDEBAND 3-CHANNEL VIDEO AMPLIFIER

3. Maximum gain  $G_v$  is calculated using the equation shown below:

$$G_v = 20 \log \frac{V_{OR1}(V_{OG1}, V_{OB1})[VP-P]}{0.7[VP-P]}$$

4. Relative maximum gain  $\Delta G_v$  is calculated using the equation shown below:

**VCR1 and  $\Delta VCR1$** 

1. Test conditions are the same as specified in the electrical characteristic table, except that V13 is set to 6.0 V.
2. Read T.P20(T.P24, T.P28) amplitude. This amplitude is referred to as  $V_{OR2}$  ( $V_{OG2}, V_{OB2}$ ).
3. Contrast control characteristic  $V_{CR1}$  and relative contrast control characteristic  $\Delta V_{CR1}$  are calculated as shown below:

$$V_{CR1} = 20 \log \frac{V_{OR2}(V_{OG2}, V_{OB2})[VP-P]}{0.7[VP-P]}$$

$$\Delta V_{CR1} = V_{OR2}/V_{OG2}, V_{OG2}/V_{OB2}, V_{OB2}/V_{OR1}$$

**VCR2 and  $\Delta VCR2$** 

1. Test conditions are the same as specified in the electrical characteristic table, except that V13 is set to 3.0 V.
2. Read T.P20(T.P24, T.P28) amplitude. This amplitude is referred to as  $V_{OR3}$  ( $V_{OG3}, V_{OB3}$ ), and is evaluated as  $V_{CR2}$ .
3. Relative contrast control characteristic  $\Delta V_{CR2}$  is calculated as follows:

$$\Delta V_{CR2} = V_{OR3}/V_{OG3}, V_{OG3}/V_{OB3}, V_{OB3}/V_{OR3}$$

**VSCR1 and  $\Delta VSCR1$** 

1. Test conditions are the same as specified in the electrical characteristic table, except that V3, V7 and V11 are set to 6.0 V.
2. Read T.P20(T.P24, T.P28) amplitude. This amplitude is called  $V_{OR4}$  ( $V_{OG4}, V_{OB4}$ ).
3. Sub contrast control characteristic  $V_{SCR1}$  and relative sub contrast control characteristic  $\Delta V_{SCR1}$  are calculated as shown below:

$$V_{SCR1} = 20 \log \frac{V_{OR4}(V_{OG4}, V_{OB4})[VP-P]}{0.7[VP-P]}$$

$$\Delta V_{SCR1} = V_{OR4}/V_{OG4}, V_{OG4}/V_{OB4}, V_{OB4}/V_{OR4}$$

**VSCR2 and  $\Delta VSCR2$** 

1. Test conditions are the same as specified in the electrical characteristic table, except that V3, V7 and V11 are set to 3.0 V.
2. Read T.P20(T.P24, T.P28) amplitude. This amplitude is called  $V_{OR5}$  ( $V_{OG5}, V_{OB5}$ ), is evaluated as  $V_{SCR2}$ .
3. Relative contrast control characteristic  $\Delta V_{SCR2}$  is calculated as shown below:

$$\Delta V_{SCR2} = V_{OR5}/V_{OG5}, V_{OG5}/V_{OB5}, V_{OB5}/V_{OR5}$$

**VCR3 and  $\Delta VCR3$** 

1. Test conditions are the same as specified in the electrical characteristic table, except that V3, V7 and V11 are set to 6.0 V and V13 to 6.0 V.
2. Read T.P20(T.P24, T.P28) amplitude. This amplitude is called  $V_{OR6}$  ( $V_{OG6}, V_{OB6}$ ).
3. The gain and relative gain of contrast and sub contrast controls at the standard level are calculated as shown below:

$$V_{CR3} = 20 \log \frac{V_{OR6}(V_{OG6}, V_{OB6})[VP-P]}{0.7[VP-P]}$$

$$\Delta V_{CR3} = V_{OR6}/V_{OG6}, V_{OG6}/V_{OB6}, V_{OB6}/V_{OR6}$$

**VB1 and  $\Delta VB1$** 

1. SW18, SW22 and SW26 are set to "b." Other test conditions are the same as specified in the electrical characteristic table.
2. Read T.P20(T.P24, T.P28) output amplitude. This amplitude is called  $V_{OR7}$  ( $V_{OG7}, V_{OB7}$ ), and is evaluated as  $V_{B1}$ .
3. The relative brightness control characteristic is obtained by calculating the difference among the channels with  $V_{OR7}$ ,  $V_{OG7}$  and  $V_{OB7}$ .

$$\begin{aligned} \Delta V_{B1} &= V_{OR7} - V_{OG7} \text{ [mV]} \\ &= V_{OG7} - V_{OB7} \\ &= V_{OB7} - V_{OR7} \end{aligned}$$

**VB2 and  $\Delta VB2$** 

1. SW18, SW22 and SW26 are set to "b." Other test conditions are the same as specified in the electrical characteristic table.
2. Read T.P20(T.P24, T.P28) output amplitude. This amplitude is called  $V_{OR7'}$  ( $V_{OG7'}, V_{OB7'}$ ), and is evaluated as  $V_{B2}$ .
3. Relative brightness control characteristic  $\Delta V_{B2}$  is obtained by calculating the difference among the channels with  $V_{OR7'}$ ,  $V_{OG7'}$  and  $V_{OB7'}$ .

$$\begin{aligned} \Delta V_{B2} &= V_{OR7'} - V_{OG7'} \text{ [mV]} \\ &= V_{OG7'} - V_{OB7'} \\ &= V_{OB7'} - V_{OR7'} \end{aligned}$$

**VB3 and  $\Delta VB3$** 

1. SW18, SW22 and SW26 are set to "b." Other test conditions are as specified in the electrical characteristic table.
2. Read T.P20(T.P24, T.P28) output amplitude. This amplitude is called  $V_{OR7''}$  ( $V_{OG7''}, V_{OB7''}$ ), and is evaluated as  $V_{B3}$ .
3. The relative brightness control characteristic is obtained by calculating the difference among the channels with  $V_{OR7''}$ ,  $V_{OG7''}$  and  $V_{OB7''}$ .

$$\begin{aligned} \Delta V_{B3} &= V_{OR7''} - V_{OG7''} \\ &= V_{OG7''} - V_{OB7''} \\ &= V_{OB7''} - V_{OR7''} \end{aligned}$$

## WIDEBAND 3-CHANNEL VIDEO AMPLIFIER

**VSB1 and VSB2**

Set SW18, SW22 and SW26 to "a.", and set SUB BRIGHT (V18, V22 and V26) to 4.0 V or 3.5 V. Other conditions are the same as for VB1 and  $\Delta VB1$  test conditions, except that step 3 in the VB1 and  $\Delta VB1$  test procedure does not apply.

**Fc1,  $\Delta Fc1$ , Fc1' and  $\Delta Fc1'$** 

- Set SW18, SW22 and SW26 to "b." Other test conditions are as specified in the electrical characteristic table.
- SG3 and SG4 are input. Measure T.P20 (T.P24 or T.P28) output amplitude in the same way as Gv and  $\Delta Gv$  testing procedure.
- This measured value is referred to as:  
Output amplitude VOR1 (VOG1, VOB1) (when SG1 is input),  
Output amplitude VOR3 (VOG3, VOB3) (when SG3 is input), or  
Output amplitude VOR9 (VOG9, VOB9) (when SG4 is input),  
Frequency characteristics Fc1 and Fc1' are calculated as follows:

$$Fc1 = 20 \log \frac{VOR3(VOG3, VOB3)[VP-P]}{VOR1(VOG1, VOB1)[VP-P]}$$

$$Fc1' = 20 \log \frac{VOR9(VOG9, VOB9)[VP-P]}{VOR1(VOG1, VOB1)[VP-P]}$$

- To obtain relative frequency characteristics  $\Delta Fc1$  and  $\Delta Fc1'$ , calculate difference between Fc1 and Fc1' for each channel.

**Fc2 and Fc2'**

The testing conditions are the same as those for testing Fc1,  $\Delta Fc1$ , Fc1' and  $\Delta Fc1'$ , except that CONTRAST (V13) is set to 6.5 V.

**Fc5 and Fc5'**

The testing conditions are the same as those for testing in the Fc1,  $\Delta Fc1$ , Fc1' and  $\Delta Fc1'$ , except that CONTRAST (V13) is set to 4.5 V.

**C.T.1 and C.T.1'**

- Set SW18, SW22 and SW26 to "b." Other test conditions are as specified in the electrical characteristic table.
- Input SG3 (or SG4) to pin ⑩ (R-ch) only, and measure T.P20 (T.P24, T.P28) output waveform amplitude. The measurement is called VOR (VOG, VOB).
- Cross talk C.T.1 is calculated as shown below:

$$\text{C.T.1} = 20 \log \frac{VOG \text{ or } VOB [VP-P]}{VOR [VP-P]} \text{ [dB]} \\ (\text{C.T.1}')$$

**C.T.2 and C.T.2'**

- Change input from pin ⑩ (R-ch) to pin ⑥ (G-ch). Read output in the same manner as that for C.T.1 and C.T.1'.
- Cross talk C.T.2 is calculated as shown below:

$$\text{C.T.2} = 20 \log \frac{VOR \text{ or } VOB [VP-P]}{VOG [VP-P]} \text{ [dB]} \\ (\text{C.T.2}')$$

**C.T.3 and C.T.3'**

- Change input from pin ⑩ (R-ch) to pin ② (B-ch). Read output in the same manner as that for C.T.1 and C.T.1'.

$$\text{C.T.3} = 20 \log \frac{VOR \text{ or } VOG [VP-P]}{VOB [VP-P]} \text{ [dB]} \\ (\text{C.T.3}')$$

**Tr and Tf**

- SW18, SW22 and SW26 are set to "b." Other test conditions are as specified in the electrical characteristic table.
- Read rise time Tr1 and fall time Tf1 with an active probe, while input pulse is fluctuating between 10%~90%.
- Read rise time Tr2 and fall time Tf2 with an active probe, while changing output pulse between 10%~90%.
- Pulse characteristics Tr and Tf are calculated as follows:

$$Tr \text{ (ns)} = \sqrt{(Tr2)^2 - (Tr1)^2}$$

$$Tf \text{ (ns)} = \sqrt{(Tf2)^2 - (Tf1)^2}$$

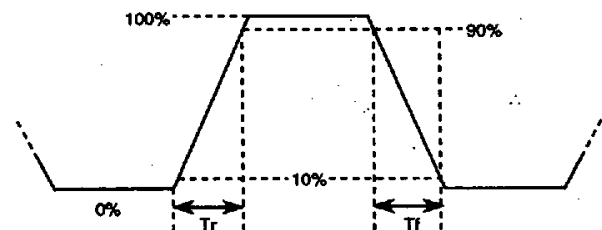
**V14th**

- SW18, SW22 and SW26 are set to "b." Other test conditions are as specified in the electrical characteristic table.
- Monitoring output (2.0 Vdc), lower the SG6 level, and measure the level when output is 0 V.

## M52327SP

## WIDEBAND 3-CHANNEL VIDEO AMPLIFIER



## W14

Under the same conditions as for V14th measurement, decrease SG6 pulse gradually, monitoring output.  
Measure the SG6 pulse width when output is 0 V.

## V27

1. Set SW18, SW22 and SW26 to "b."
2. Read T.P19, T.P23 and T.P27 outputs with voltmeter.

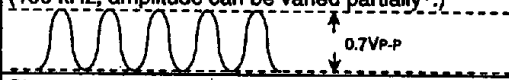
## INPUT SIGNAL

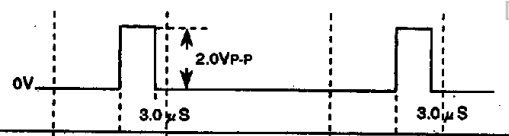
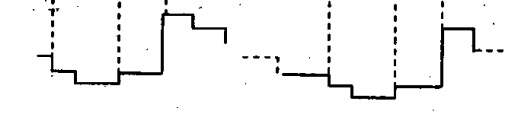
SG No.	Input signal
SG1	Sine wave with amplitude 0.7V <sub>P-P</sub> (100 kHz, amplitude can be varied partially*) 
SG2	Sine wave with amplitude 0.7V <sub>P-P</sub> (f = 10MHz)
SG3	Sine wave with amplitude 0.7V <sub>P-P</sub> (f = 50MHz)
SG4	Sine wave with amplitude 0.7V <sub>P-P</sub> (f = 100MHz)
SG5	Square wave with amplitude 0.7 V <sub>P-P</sub> (f = 1 MHz, duty = 50%) 
SG6	Pulse (amplitude 2.0 V <sub>P-P</sub> and pulse width 3.0 μs). Synchronous with standard video staircase. 
SG7 standard video staircase	

\*Refer to the electrical characteristic test procedure.





# M52327SP

## WIDEBAND 3-CHANNEL VIDEO AMPLIFIER

### TYPICAL CHARACTERISTICS

**THERMAL DERATING (MAXIMUM RATING)**

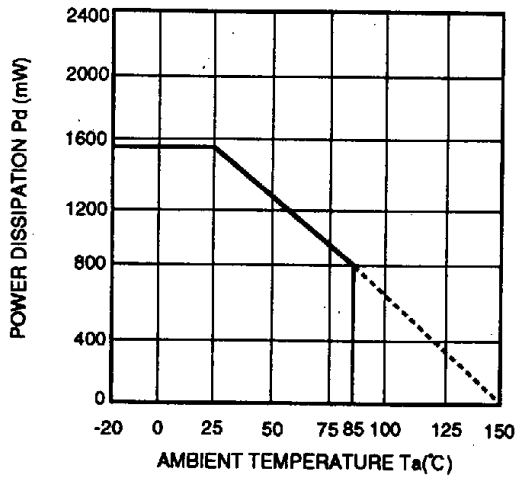

**SUB CONTRAST CHARACTERISTIC**

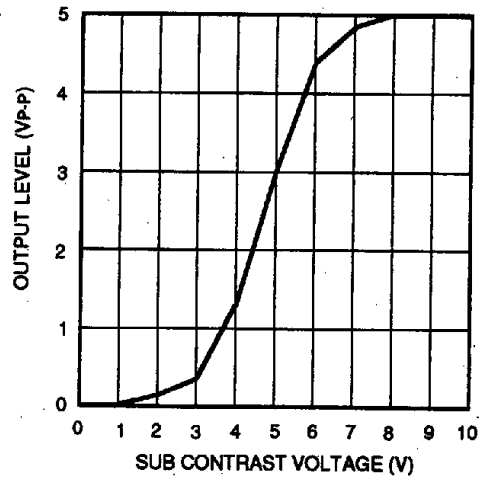

**Vcc**                    12V  
**Main contrast**        12V  
**Main brightness**     3.2V  
**Sub brightness**       0V  
**Input signal level**    0.7Vp-P

**MAIN CONTRAST CHARACTERISTIC**

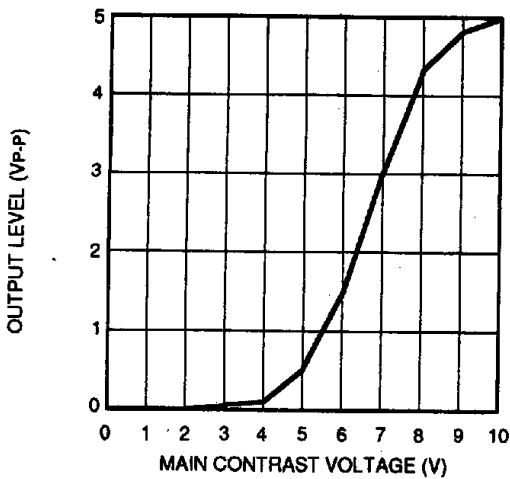

**Vcc**                    12V  
**Sub contrast**        12V  
**Main brightness**     3.2V  
**Sub brightness**       0V  
**Input signal level**    0.7Vp-P

**M52327SP RISE**

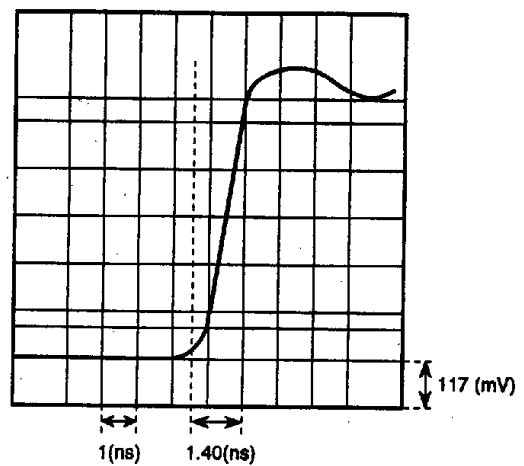

**Input signal**  
 Square wave  
**Input amplitude**    0.70 (Vp-P)  
**Tr in**                    1.40 (ns)

## WIDEBAND 3-CHANNEL VIDEO AMPLIFIER

## TYPICAL CHARACTERISTICS (cont.)

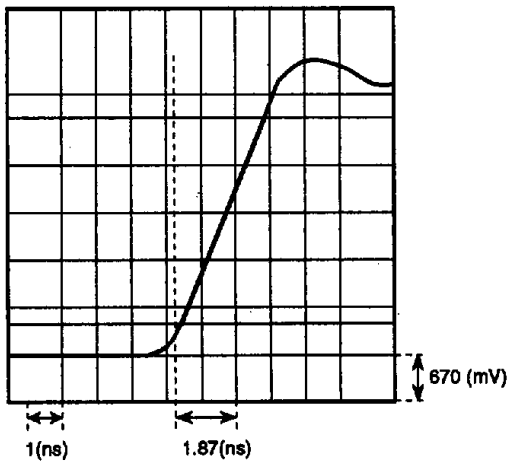

## Output signal

Output amplitude	4.0 (V <sub>P-P</sub> )
Tr out	1.87 (ns)
V <sub>CC</sub> =12V	
Main contrast	7.5V
Sub contrast	12V
Main brightness	3.2V
Sub brightness	Open

## M52327SP FALL

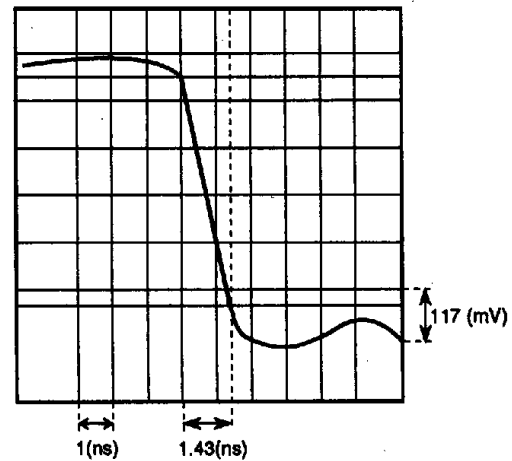

## Input signal

Square wave	
Input amplitude	0.70 (V <sub>P-P</sub> )
Tf in	1.43 (ns)

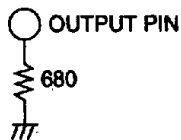

$$\begin{aligned}
 Tr &= \sqrt{(Tr \text{ out})^2 - (Tr \text{ in})^2} \\
 &= \sqrt{1.87^2 - 1.4^2} \\
 &\approx 1.24(\text{ns})
 \end{aligned}$$

## WIDEBAND 3-CHANNEL VIDEO AMPLIFIER

## TYPICAL CHARACTERISTICS (cont.)

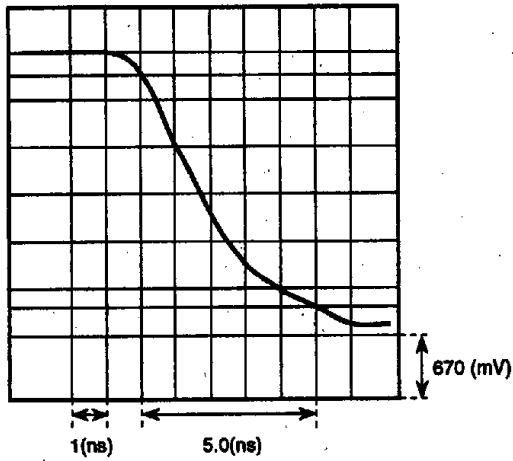

## Output signal

Output amplitude	4.0(V <sub>P-P</sub> )
Tr out	5.0(ns)
V <sub>CC</sub>	12V
Main contrast	7.5V
Sub contrast	12V
Main brightness	3.2V
Sub brightness	Open

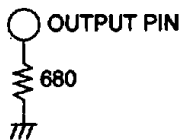

$$\begin{aligned}
 Tr &= \sqrt{(Tf \text{ out})^2 - (Tf \text{ in})^2} \\
 &= \sqrt{5^2 - 1.43^2} \\
 &= 4.8(\text{ns})
 \end{aligned}$$

WIDEBAND 3-CHANNEL VIDEO AMPLIFIER

APPLICATION EXAMPLE 1

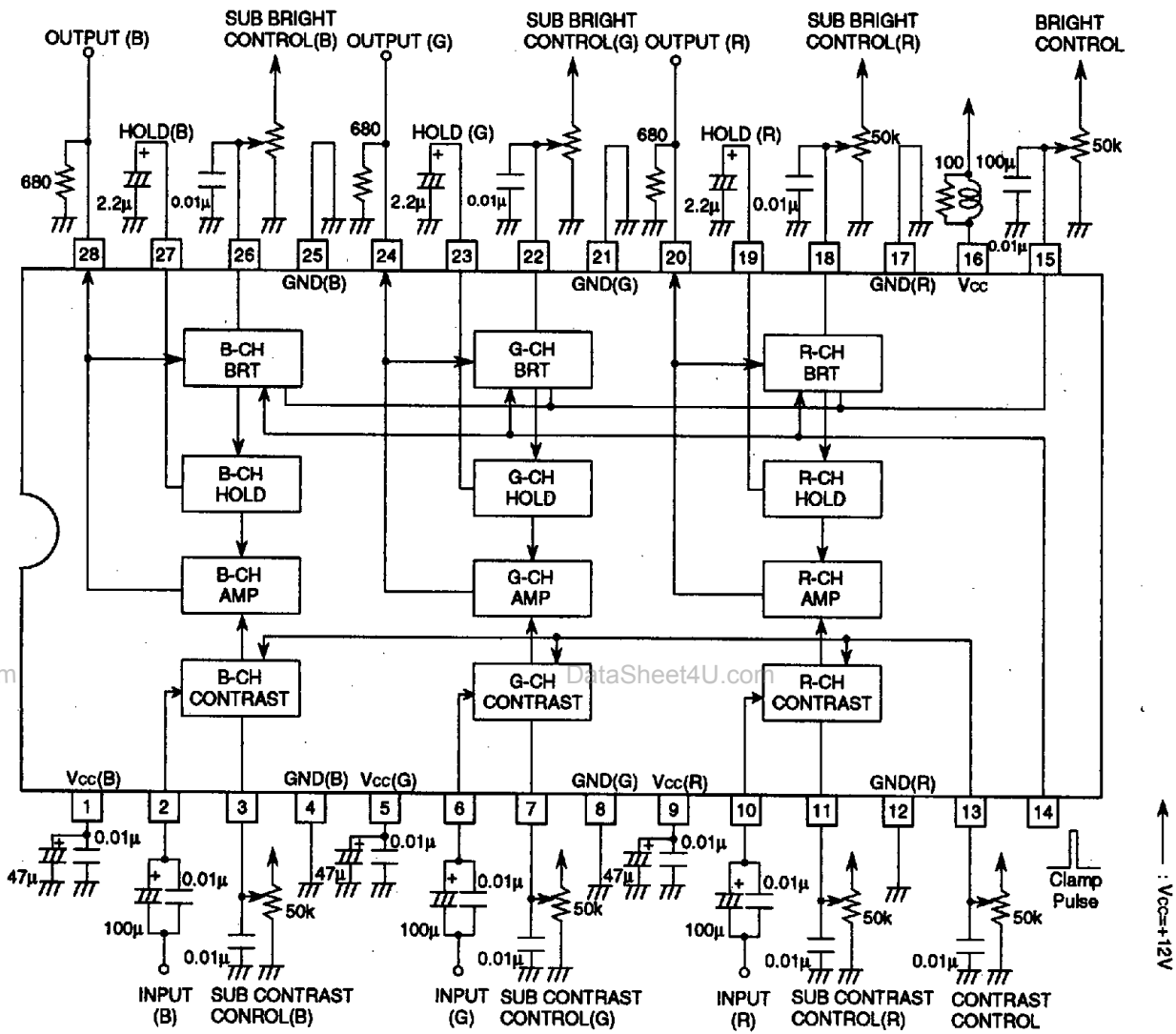

Units Resistance: Ω  
Capacitance: F

WIDEBAND 3-CHANNEL VIDEO AMPLIFIER

APPLICATION EXAMPLE 2

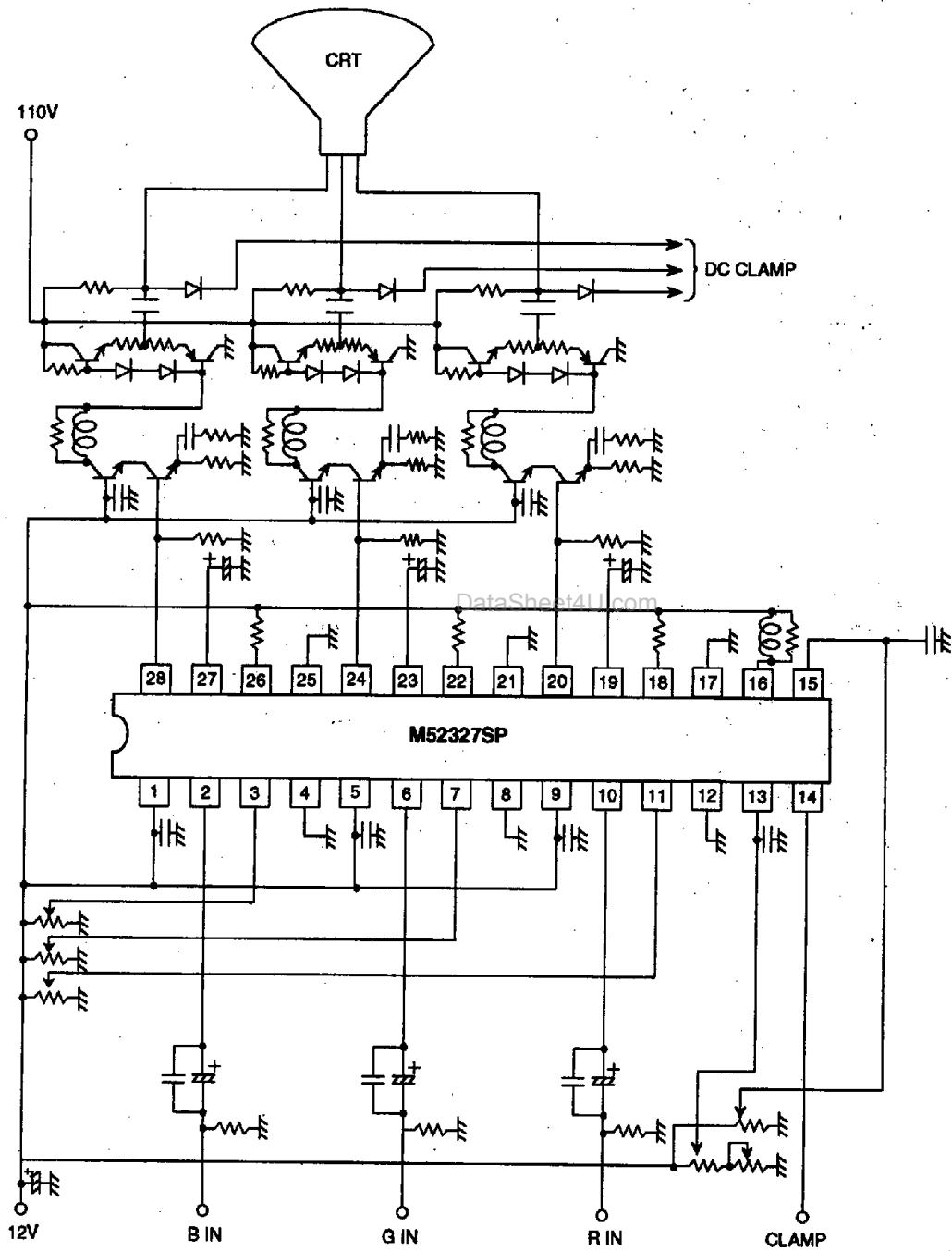

Units Resistance:  $\Omega$   
Capacitance: F

## M52327SP

## WIDEBAND 3-CHANNEL VIDEO AMPLIFIER

## DESCRIPTION OF PIN

Pin No.	Name	Voltage and wave information	Peripheral circuit of pins	Remark
① ⑤ ⑨	VCC (B-ch) VCC (G-ch) VCC (R-ch)	12V	—	Apply equivalent voltage to 3 channels.
② ⑥ ⑩	B-IN G-IN R-IN	2.9V		—
③ ⑦ ⑪	B SUB CONTRAST G SUB CONTRAST R SUB CONTRAST	4.0V		—
④ ⑤ ⑧ ⑨ ⑫ ⑬	GND(B-ch) GND(G-ch) GND(R-ch)	GND	—	—
⑬	CONTRAST	6.9V		—
⑭	CLAMP PULSE	—		—

**M52327SP****WIDEBAND 3-CHANNEL VIDEO AMPLIFIER****DESCRIPTION OF PIN (cont.)**

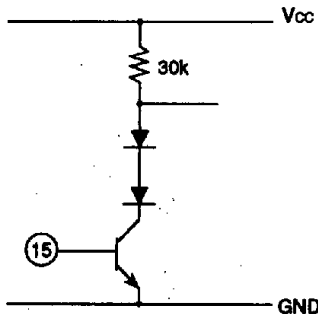
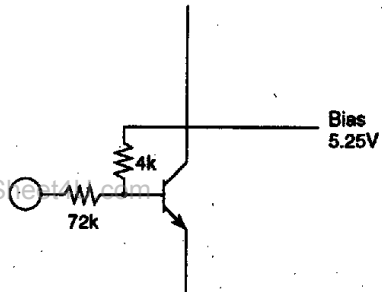
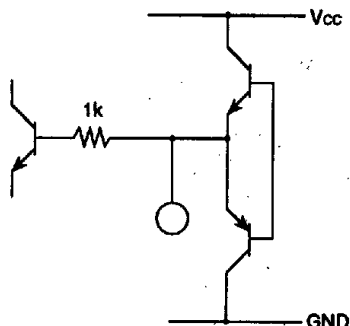
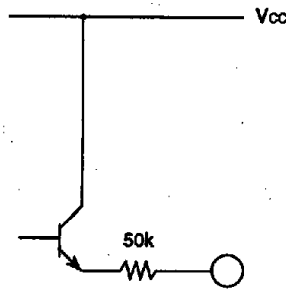
Pin No.	Name	Voltage and wave information	Peripheral circuit of pins	Remark
⑮	BRIGHT	—		—
⑯	Vcc	12V	—	—
⑰ ⑳ ㉑	R SUB BRIGHT G SUB BRIGHT B SUB BRIGHT	—		—
⑲ ㉒ ㉓	R HOLD G HOLD B HOLD	Variable		—
㉔ ㉕ ㉖	R OUT G OUT B OUT	Variable		Resistance is necessary on the GND side. Set the resistance for current to be no more than 15mA, according to the driver capacity.

WIDEBAND 3-CHANNEL VIDEO AMPLIFIER

APPLICATION INSTRUCTIONS

1) Clamp pulse input

The clamp pulse is wired as shown in the illustration.

The inputs are:

$V_{TH} = 2.2V - \text{Diode} \times 1$

$V_{TH} = 1.5V$

Voltage in excess of 2.2V is suppressed. The recommended voltage level is as shown in the illustration.

The recommended pulse width is as follows:

1.0  $\mu$  sec or more at 15 kHz

0.5  $\mu$  sec or more at 30 kHz

0.3  $\mu$  sec or more at 64 kHz

The clamp pulse wiring is usually long in TV sets. It is sometimes led from the high voltage side, or connected indirectly to an external pin.

Under such conditions, the wiring may possibly be exposed to high surge voltage. It is recommended that a safety circuit be provided as shown in the illustration on the right.

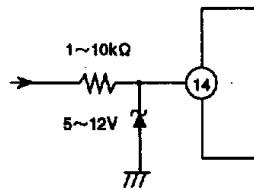
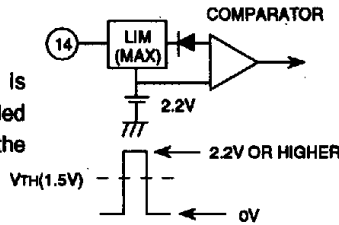

2-2) Sub brightness pin

As described above, this pin's internal layout is completely different from that of M51387P.

a) When sub brightness control is set to be unvariable:

Set all control pins to Vcc. If external voltage may interfere with the sub brightness pin due to the circuit board layout and this may influence IC output, consider adding bypass capacitors.

b) When sub brightness control is set to be variable:

Control characteristics are as shown below:

SUB BRIGHT CONTROL CHARACTERISTICS

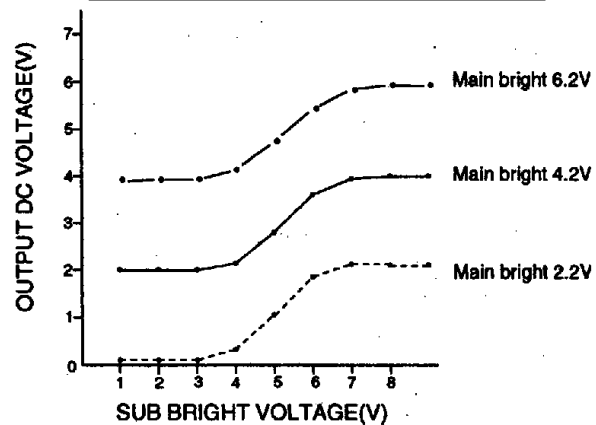

2) Main/sub brightness control

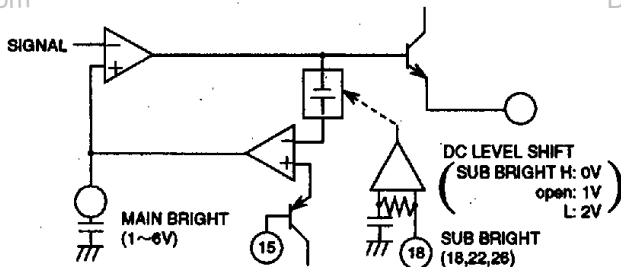

The mechanism is as shown in the illustration above. While M51387P has a sub brightness pin built directly in the signal feedback group, this IC has the pin built indirectly, preventing signal output to the sub brightness pin.

2-1) Main brightness pin

Use in a range between 1V~6V.

The control characteristics are as shown below:

MAIN BRIGHT CONTROL CHARACTERISTICS

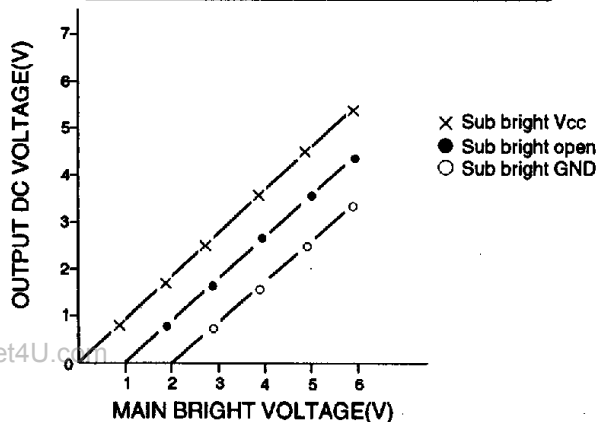

2-3) Hold capacitor capacitance

Capacitance of no less than 1,000 pF is required when f<sub>H</sub> is 15 kHz. However, the required capacitance varies depending on the hold period (operating period except during clamping). Larger capacitance may be necessary if the hold period is longer.

The smaller the capacitance, the quicker the response, and the larger the capacitance, the stable the response. Set the capacitance according to clamp pulse conditions (especially vertical sync timing pulse conditions).

M52327SP Cross talk

Measuring conditions

Main: Contrast pin voltage 12V

Sub: Contrast pin voltage 12V

Main: Brightness pin voltage 5V

Sub: Brightness pin voltage Open

Input signal 0.7 V<sub>P-P</sub> sine wave

		Input frequency				Unit
		10MHz	50MHz	75MHz	100MHz	
CT1	R→G	-45	-29	-23	-18	dB
	R→B	-60	-38	-30	-20	
CT2	G→R	-60	-34	-23	-18	dB
	G→B	-45	-26	-20	-18	
CT3	B→R	-65	-35	-23	-19	dB
	B→G	-60	-40	-29	-26	



## WIDEBAND 3-CHANNEL VIDEO AMPLIFIER

Cross talk CT1 inputs signals only to pin ⑩ (R-ch). The output waveform amplitudes at pin ④, ⑥ and ⑧ are called, respectively, VOR, VOG and VOB.

$$CT1 = 20 \log_{10} \frac{V_{OG} \text{ or } V_{OB}}{V_{OR}} \quad [\text{dB}]$$

Cross talk CT2 can be calculated in the same way, except that signals are input to pin ⑥ (G-ch).

$$CT2 = 20 \log_{10} \frac{V_{OR} \text{ or } V_{OB}}{V_{OG}} \quad [\text{dB}]$$

Cross talk CT3 can be calculated in the same way, except that signals are input to pin ④ (B-ch).

$$CT3 = 20 \log_{10} \frac{V_{OR} \text{ or } V_{OG}}{V_{OB}} \quad [\text{dB}]$$

## CIRCUIT BOARD PRODUCTION INSTRUCTIONS

This IC has a built-in wideband amplifier, therefore oscillation may be generated depending on the circuit board wiring layout. Follow the instructions listed below to prevent it.

- Make wiring between output pin and resistance as short as possible.
- Minimize output pin loading capacitance.
- Provide Vcc-GND-line and DC-line bypass capacitors close to the pin.
- Use a stable supply for Vcc. (The four supplies are desired to be independent of each other.)
- To reduce oscillation, connect a resistance of dozens of ohms between each output pin and the next stage.
- Connecting a coil and a resistor to pin ⑩ Vcc may also be effective depending on the circuit board.

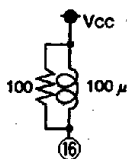

- Check if signals are not deviated from the power stage.
- GND should be as wide as possible. It should be an all-over spread GND pattern as a matter of rule.
- Hold capacitance should be connected to stable GND to be as close to the pin as possible.

## IC OPERATION REMARKS

- It is recommended to control pedestal voltage between 2V ~ 3V for reduction of distortion.
- Apply sufficiently low impedance to each input.