



36V-Capable Overvoltage Protector with Regulated Output Voltage

MAX14562

General Description

The MAX14562 protects valuable consumer circuits against voltage faults of up to +36V. This robust protection is implemented in a three-step scheme for a superior result. If the input is below the preset regulated output-voltage (VPROV) threshold, the output tracks the input minus the voltage drop (RON x ILOAD) across the pass FET. If the input exceeds VPROV, the output is regulated to VPROV. If the input rises further and exceeds the overvoltage lockout cutoff threshold (VOVLO), the output is disconnected from the input.

A low resistance 160mΩ (typ) FET is integrated in the MAX14562, effectively reducing the component count and application footprint. The MAX14562 also features thermal shutdown protection against a short-circuit event.

The MAX14562 is specified over the extended -40°C to +85°C temperature range and is available in 8-pin TDFN (2mm x 2mm) package.

Applications

- | | |
|-----------------------|------------------------|
| Mobile Phones | Digital Cameras |
| Smartphones | Bluetooth Headset |
| Portable Media Player | E-Book |
| PDAs | Mobile Internet Device |

Features

- ◆ Input Voltage Protection Up to +36V
- ◆ Preset Regulated Output Voltage (+5.15V typ)
- ◆ Integrated 160mΩ (typ) N-Channel MOSFET Switch
- ◆ Soft-Start to Minimize In-Rush Current
- ◆ Overvoltage Cutoff Protection +8V (typ)
- ◆ Thermal Shutdown Protection
- ◆ -40°C to +85°C Operating Temperature Range

Ordering Information

PART	TEMP RANGE	PIN-PACKAGE	TOP MARK
MAX14562ETA+T	-40°C to +85°C	8 TDFN-EP*	ADI

+ Denotes a lead(Pb)-free/RoHS-compliant package.

T = Tape and reel.

*EP = Exposed pad.

Typical Operating Circuit

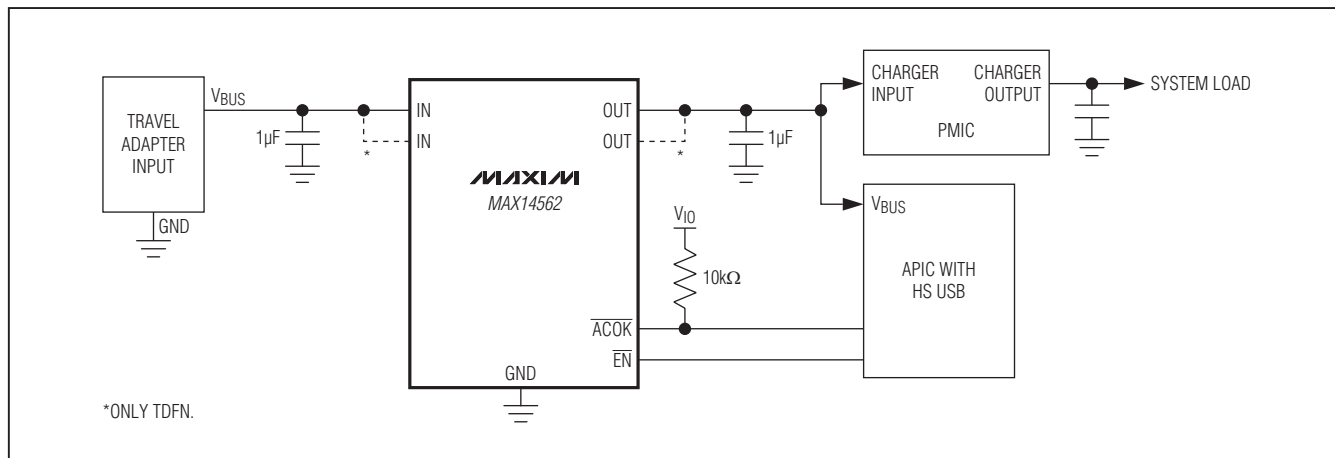

36V-Capable Overvoltage Protector with Regulated Output Voltage

ABSOLUTE MAXIMUM RATINGS

(Voltages referenced to GND.)

IN	-0.3V to +40V
OUT	-0.3V to +6V
EN, ACOK	-0.3V to +6V
Continuous Current Through IN/OUT	
8-Pin TDFN	±1.6A
10ms Current Through IN/OUT	
8-Pin TDFN	±2A

Continuous Power Dissipation ($T_A = +70^\circ\text{C}$):

8-Pin TDFN (derate 11.9mW/ $^\circ\text{C}$ above $+70^\circ\text{C}$)	953mW
Operating Temperature Range	-40°C to $+85^\circ\text{C}$
Storage Temperature Range	-65°C to $+150^\circ\text{C}$
Junction Temperature	$+150^\circ\text{C}$
Lead Temperature (soldering, 10s)	$+300^\circ\text{C}$
Soldering Temperature (reflow)	$+260^\circ\text{C}$

Stresses beyond those listed under "Absolute Maximum Ratings" may cause permanent damage to the device. These are stress ratings only, and functional operation of the device at these or any other conditions beyond those indicated in the operational sections of the specifications is not implied. Exposure to absolute maximum rating conditions for extended periods may affect device reliability.

PACKAGE THERMAL CHARACTERISTICS (Note 1)

TDFN

Junction-to-Ambient Thermal Resistance (θ_{JA}) 83.9 $^\circ\text{C}/\text{W}$

Junction-to-Case Thermal Resistance (θ_{JC}) 37 $^\circ\text{C}/\text{W}$

Note 1: Package thermal resistances were obtained using the method described in JEDEC specification JESD51-7, using a four-layer board. For detailed information on package thermal considerations, refer to www.maxim-ic.com/thermal-tutorial.

ELECTRICAL CHARACTERISTICS

($V_{IN} = +2.2\text{V}$ to $+36\text{V}$, $T_A = -40^\circ\text{C}$ to $+85^\circ\text{C}$, unless otherwise noted. Typical values are at $V_{IN} = +5.0\text{V}$ and $T_A = +25^\circ\text{C}$.) (Note 2)

PARAMETER	SYMBOL	CONDITIONS	MIN	TYP	MAX	UNITS	
Input Voltage	V_{IN}		2.2		36	V	
Preset Regulated Output Voltage	V_{PROV}	$I_{OUT} = 0\text{mA}$, $V_{IN} = 6.5\text{V}$	4.85	5.15	5.45	V	
		$I_{OUT} = 200\text{mA}$, $V_{IN} = 6.5\text{V}$	4.75	5.15	5.45		
		$I_{OUT} = 800\text{mA}$, $V_{IN} = 6\text{V}$ (Note 3)	4.75	5.15	5.45		
Output Voltage	V_{OUT}	$I_{OUT} = 0\text{mA}$, $V_{IN} > V_{PROV}$	V_{PROV}			V	
		$V_{IN} < V_{PROV}$ (Note 4)	V_{IN}			V	
Overvoltage Lockout Cutoff Threshold Rising	V_{OVLO}	IN rising	7.44	8	8.56	V	
Overvoltage Lockout Hysteresis		% of typ V_{OVLO}	1			%	
Input Supply Current	I_{IN}	$\overline{EN} = \text{low}$, $V_{IN} = 4.5\text{V}$, $I_{OUT} = 0\text{mA}$	120			260	μA
		$\overline{EN} = \text{low}$, $V_{IN} = 7\text{V}$, $I_{OUT} = 0\text{mA}$	300			550	
Input Shutdown Current	I_{IN_Q}	$\overline{EN} = \text{high}$, $V_{IN} = 3\text{V}$	2.5			5	μA
OUT Shutdown Current		$V_{IN} = 5\text{V}$, $V_{OUT} = 4\text{V}$, $\overline{EN} = \text{high}$	-1			+1	μA
On-Resistance	R_{ON}	$V_{IN} = 4.75\text{V}$, $I_{OUT} = 100\text{mA}$				280	$\text{m}\Omega$
LDO Load Capacitance		I_{OUT} up to 0.8A	10			μF	
DIGITAL SIGNALS (\overline{EN}, \overline{ACOK})							
\overline{EN} Input High Voltage	V_{IH}		1.4			V	
\overline{EN} Input Low Voltage	V_{IL}					0.4	V
\overline{EN} Input Leakage Current	I_{LEAK}	$\overline{VEN} = 0\text{V}$ or 5.5V	-150			+150	nA
\overline{ACOK} Output Low Voltage	V_{OL}	$V_{IO} = 3.3\text{V}$, $I_{SINK} = 1\text{mA}$ (see <i>Typical Operating Circuit</i>)				0.4	V
\overline{ACOK} Leakage Current		$V_{IO} = 3.3\text{V}$, \overline{ACOK} deasserted (see <i>Typical Operating Circuit</i>)	-200			+200	nA

36V-Capable Overvoltage Protector with Regulated Output Voltage

MAX14562

ELECTRICAL CHARACTERISTICS (continued)

($V_{IN} = +2.2V$ to $+36V$, $T_A = -40^{\circ}C$ to $+85^{\circ}C$, unless otherwise noted. Typical values are at $V_{IN} = +5.0V$ and $T_A = +25^{\circ}C$.) (Note 2)

PARAMETER	SYMBOL	CONDITIONS	MIN	TYP	MAX	UNITS
TIMING CHARACTERISTICS (Note 4)						
Input Debounce Time	t_{DEB}	$V_{IN_MIN} < V_{IN} < V_{OVLO}$ until charge pump turns on, see Figure 1	10	20	35	ms
\overline{ACOK} Time	$t_{\overline{ACOK}}$	$V_{IN_MIN} < V_{IN} < V_{OVLO}$ to \overline{ACOK} low until charge pump turns on, see Figure 1	20	40	70	ms
Turn-on Time During Soft-Start	t_{ON}	$R_{LOAD} = 100\Omega$, $C_{LOAD} = 1\mu F$, $V_{OUT} = 20\%$ of V_{IN} to 80% of V_{IN} , see Figure 1		48		μs
Overvoltage Turn-Off Time	t_{OFF}	$V_{IN} > V_{OVLO}$ to $V_{OUT} = 80\%$ of V_{PROV} , $R_{LOAD} = 100\Omega$, see Figure 1		1		μs
THERMAL PROTECTION						
Thermal Shutdown	T_{SHDN}			150		$^{\circ}C$
Thermal Hysteresis	T_{HYST}			20		$^{\circ}C$

Note 2: All devices are 100% production tested at $T_A = +25^{\circ}C$. Limits over the operating temperature range are guaranteed by design and not production tested.

Note 3: Thermally limited, guaranteed by design, and not production tested.

Note 4: In linear mode, as I_{OUT} increases, the OUT voltage drops due to a voltage across Q1 (see *Functional Diagram*).

Note 5: All timing characteristics are measured using 20% and 80% levels unless otherwise specified.

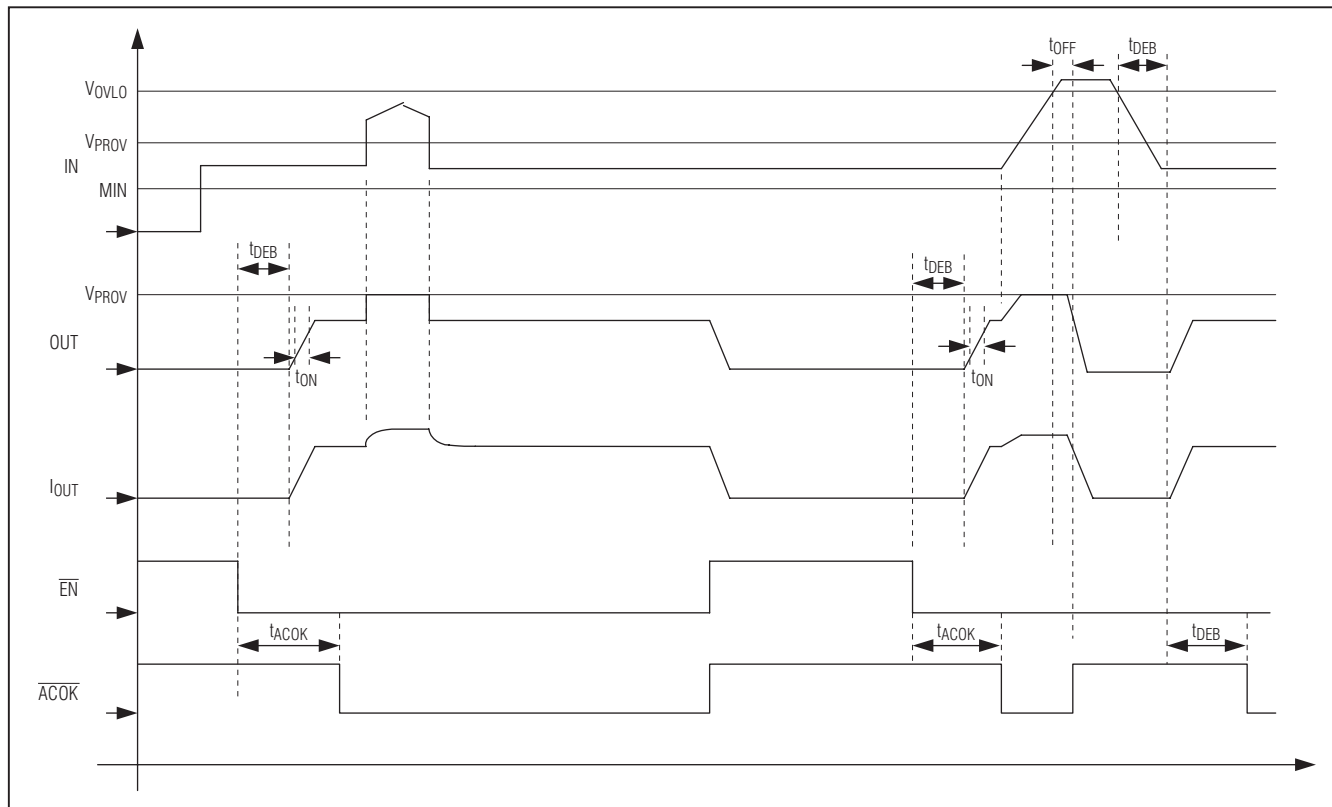
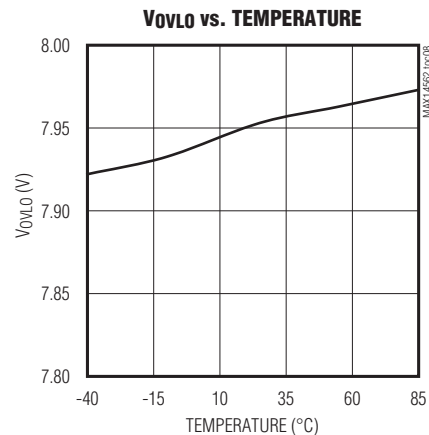
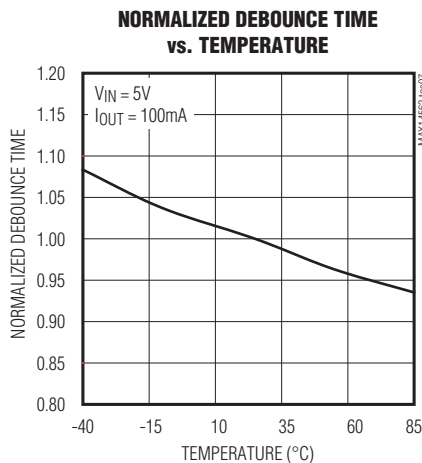
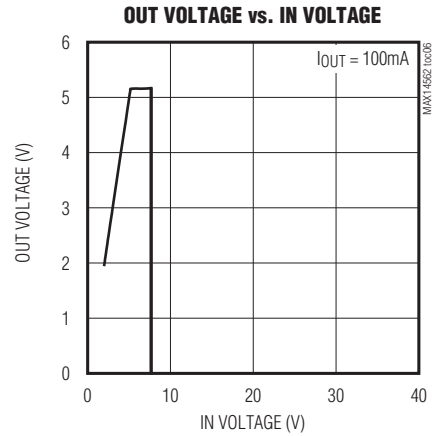
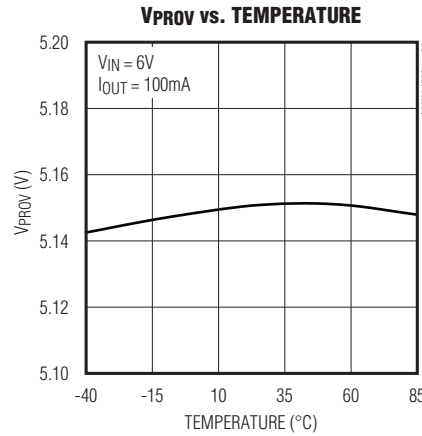
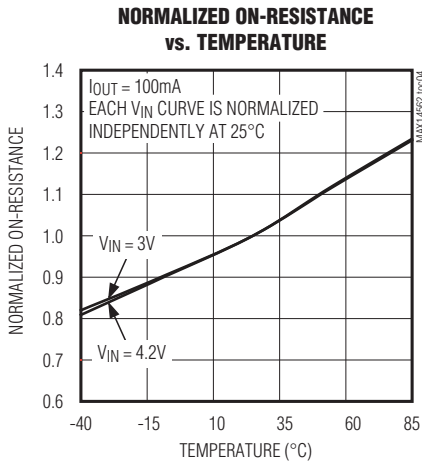
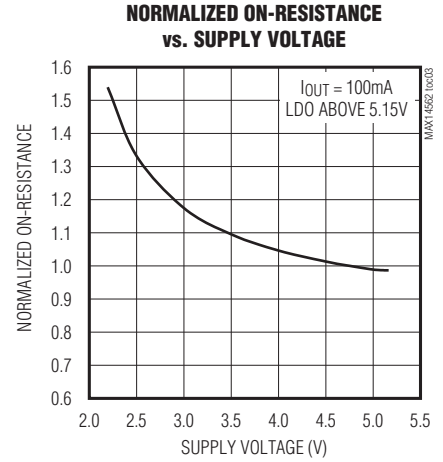
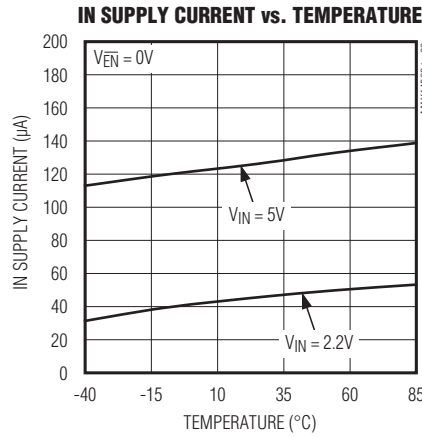
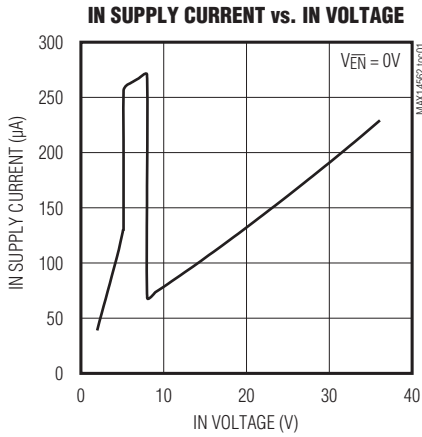

Figure 1. Enable/Select Time

36V-Capable Overvoltage Protector with Regulated Output Voltage

Typical Operating Characteristics

($C_{IN} = 1\mu F$, $C_{OUT} = 4.7\mu F$, $T_A = +25^\circ C$, unless otherwise noted.)



36V-Capable Overvoltage Protector with Regulated Output Voltage

Typical Operating Characteristics (continued)

($C_{IN} = 1\mu\text{F}$, $C_{OUT} = 4.7\mu\text{F}$, $T_A = +25^\circ\text{C}$, unless otherwise noted.)

MAX14562

IN RISE TRANSIENT RESPONSE
($I_{OUT} = 10\text{mA}$)

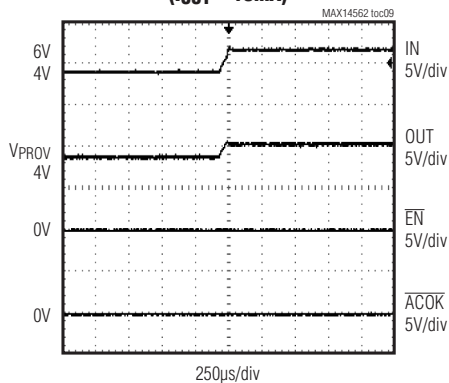

IN FALL TRANSIENT RESPONSE
($I_{OUT} = 10\text{mA}$)

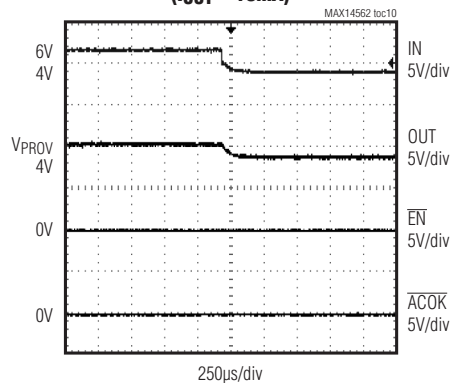

LOAD TRANSIENT
($V_{EN} = 0\text{V}$)

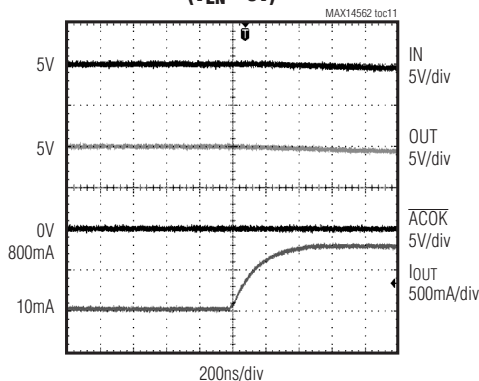

LOAD TRANSIENT
($V_{EN} = 0\text{V}$)

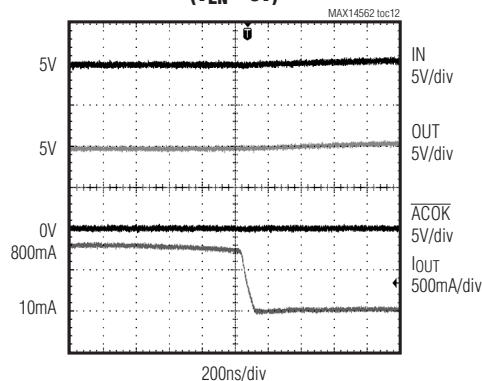

SWITCH TURN-ON TIME RESPONSE
($R_{LOAD} = 100\Omega$)

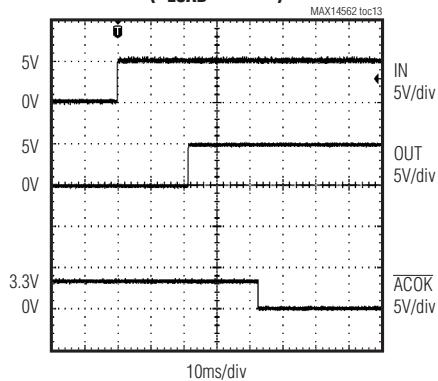

SWITCH TURN-OFF TIME RESPONSE
($R_{LOAD} = 100\Omega$)

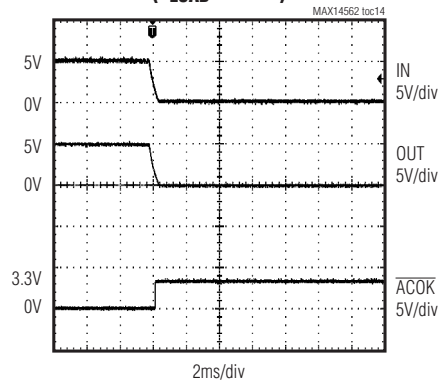

36V-Capable Overvoltage Protector with Regulated Output Voltage

Typical Operating Characteristics (continued)

(C_{IN} = 1μF, C_{OUT} = 4.7μF, T_A = +25°C, unless otherwise noted.)

**POWER-UP RESPONSE
(C_{LOAD} = 470μF)**

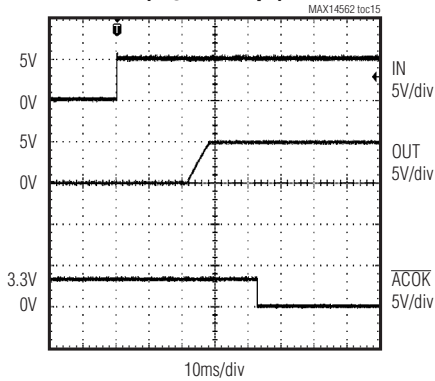

**POWER-UP RESPONSE
(C_{LOAD} = 470μF)**

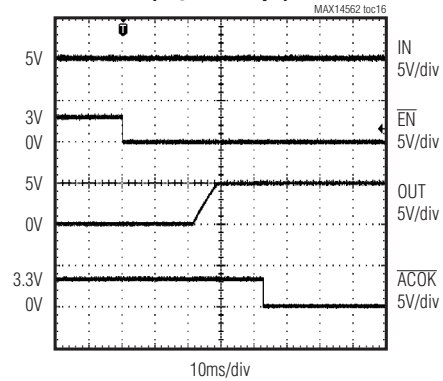

**ACOK RESPONSE (OVERVOLTAGE CONDITION)
(R_{LOAD} = 50Ω)**

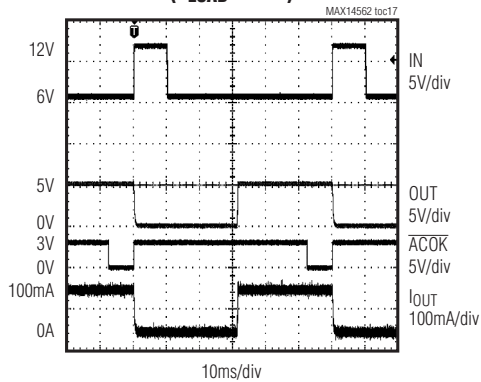

**OUT SHORT SHUTDOWN
(THERMAL)**

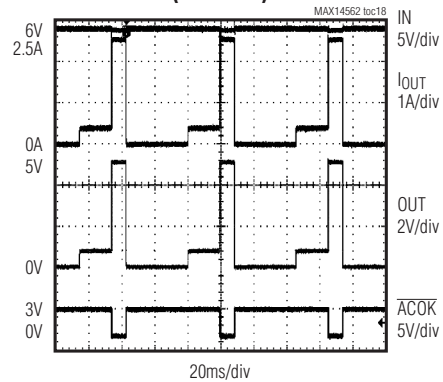

36V-Capable Overvoltage Protector with Regulated Output Voltage

Pin Configuration

MAX14562

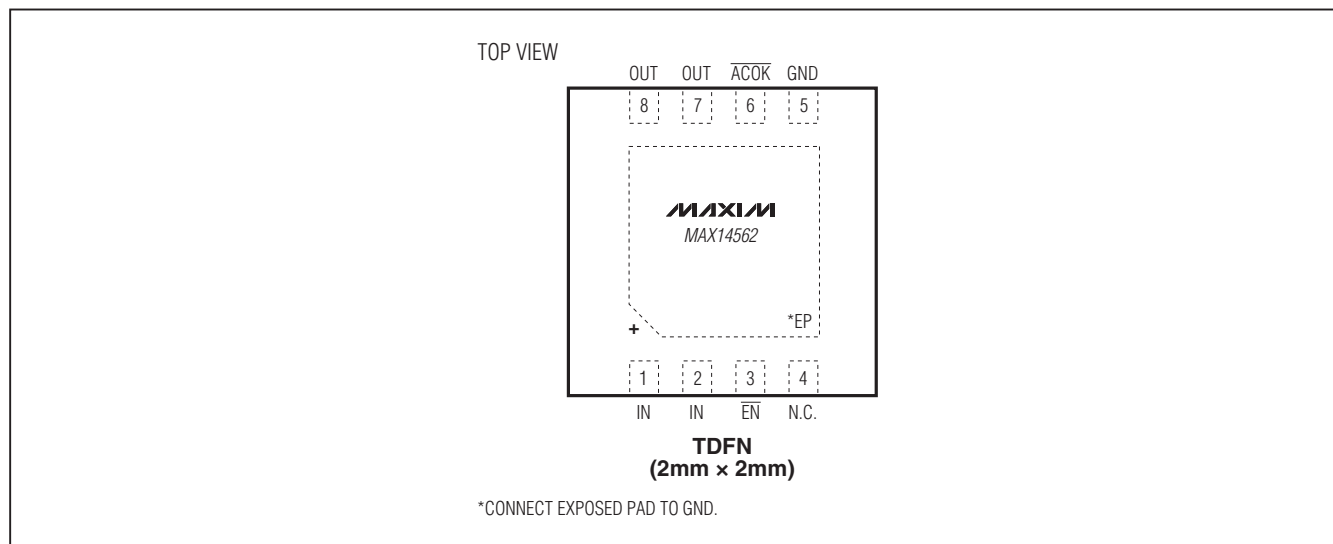

Pin Description

PIN	NAME	FUNCTION
1,2	IN	Overvoltage Protection Input. Bypass IN with a 1 μ F ceramic capacitor to get \pm 15kV HBM ESD protection. No capacitor is required for \pm 2kV HBM ESD protection. Externally connect both IN pins together.
3	$\overline{\text{EN}}$	Active-Low Enable Input. Drive $\overline{\text{EN}}$ low to turn on the device. Drive $\overline{\text{EN}}$ high to turn off the device.
4	N.C.	No Connection. Not internally connected.
5	GND	Ground
6	$\overline{\text{ACOK}}$	Open-Drain Flag Output. $\overline{\text{ACOK}}$ is driven low after input voltage is stable between minimum V_{IN} and V_{OVLO} after soft-start time (double of debounce time). Connect a pullup resistor from $\overline{\text{ACOK}}$ to the logic I/O voltage of the host system.
7,8	OUT	Overvoltage Protection Output. Bypass OUT with a 1 μ F or larger ceramic capacitor (see Table 1). Externally connect both OUT pins together.
—	EP	Exposed Pad. Connect EP to GND.

36V-Capable Overvoltage Protector with Regulated Output Voltage

Functional Diagram

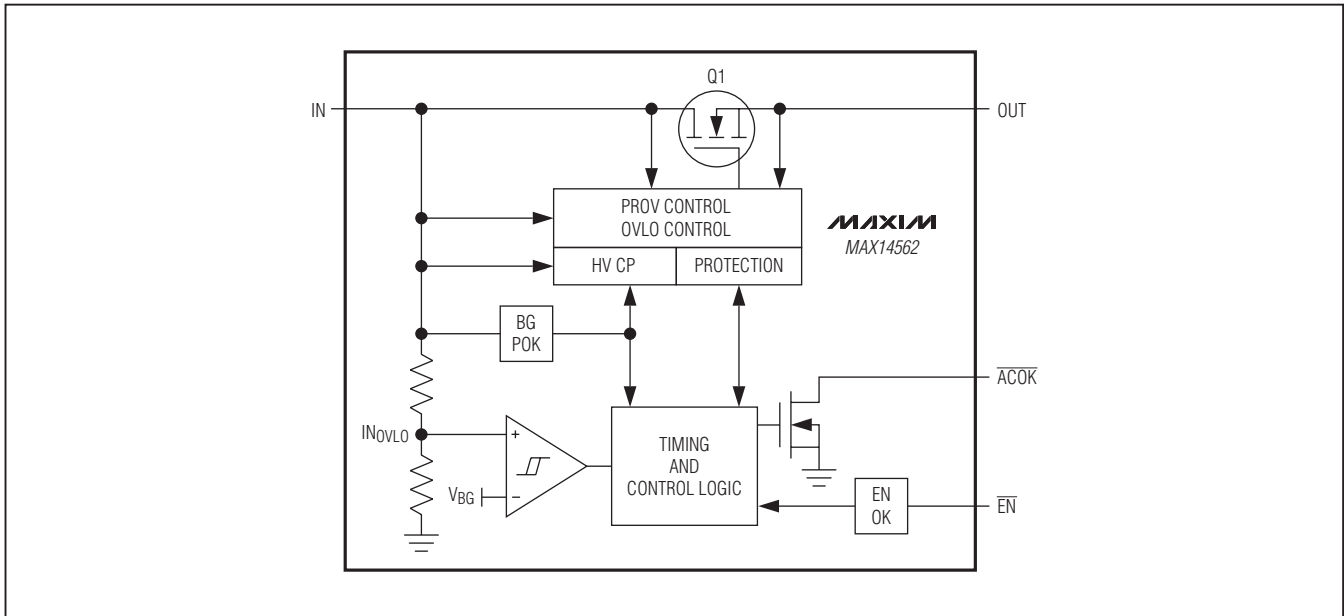

Detailed Description

The MAX14562 features the overvoltage protection to the charger input V_{BUS} line when a travel adapter (TA) is used. In addition, the MAX14562 features a low 160m Ω (typ) on-resistance internal FET (Q1) and protects the low-voltage system against voltage faults up to +36V.

The MAX14562 features three-step overvoltage protection. When the input is below the preset regulated output-voltage (V_{PROV}) threshold, the output follows the input minus the voltage drop across the pass FET ($R_{ON} \times I_{LOAD}$). When the input exceeds V_{PROV} , the output is regulated to V_{PROV} . If the input rises further and exceeds the overvoltage lockout cutoff (V_{OVLO}) threshold, the output is disconnected from the input. The MAX14562 also features thermal shutdown protection against short-circuit events.

Soft-Start

To minimize inrush current, the MAX14562 features a soft-start capability to slowly turn on Q1.

Soft-start function permits the device to charge the load capacitor up to 1000 μ F by controlled current. The soft-start is initiated when the debounce time ends (OUT

starts charging) and ends when \overline{ACOK} is asserted low, 15ms (typ).

Linear Mode

When the input voltage exceeds the minimum IN voltage but is below V_{PROV} , OUT follows IN with a minimum voltage drop ($R_{ON} \times I_{LOAD}$) across pass FET after the debounce time, t_{DEB} , and \overline{ACOK} is asserted.

The LDO mode needs a capacitor on OUT. The recommended value is 10 μ F for load currents up to 800mA (Table 1).

Preset Regulated Output-Voltage Mode (PROV)

When IN goes above the preset regulated output voltage (V_{PROV}), Q1 provides a constant voltage of V_{PROV} at OUT, and \overline{ACOK} is asserted.

Table 1. Recommended Load Capacitance

LOAD CURRENT (mA)	LOAD CAP (μ F)
10	1
50	2.2
100	4.7
800	10

36V-Capable Overvoltage Protector with Regulated Output Voltage

MAX14562

Overvoltage Lockout Mode (OVLO)

When IN goes above the overvoltage lockout threshold (VOVLO), OUT is disconnected from IN and $\overline{\text{ACOK}}$ is deasserted. Power dissipation increases when the input goes higher than VPROV. The overvoltage lockout threshold is set to further the power dissipation. When IN drops below VOVLO, the debounce time starts counting. After the debounce time (2 x tDEB), OUT follows IN again and $\overline{\text{ACOK}}$ is asserted.

Thermal Shutdown

The MAX14562 features a thermal shutdown function necessary to protect the device. The device turns off and $\overline{\text{ACOK}}$ is deasserted when the junction temperature exceeds +150°C (typ). When the temperature drops 20°C (typ) below 150°C (typ), the device turns back on and Q1 is turned on after the debounce time.

Applications Information

Power-Supply Decoupling

Bypass IN pin(s) to ground with a 1 μ F or larger ceramic capacitor placed as close as possible to the device.

Chip Information

PROCESS: BiCMOS

Package Information

For the latest package outline information and land patterns, go to www.maxim-ic.com/packages. Note that a "+", "#", or "-" in the package code indicates RoHS status only. Package drawings may show a different suffix character, but the drawing pertains to the package regardless of RoHS status.

PACKAGE TYPE	PACKAGE CODE	OUTPUT NO.	LAND PATTERN NO.
8 TDFN-EP	T822+1	21-0168	90-0064

36V-Capable Overvoltage Protector with Regulated Output Voltage

Revision History

REVISION NUMBER	REVISION DATE	DESCRIPTION	PAGES CHANGED
0	9/10	Initial release	—
1	8/11	Removed SC70 pin information from data sheet. Added additional conditions to Preset Regulated Output Voltage parameter in the <i>Electrical Characteristics</i> table	1, 2, 3, 7, 9

Maxim cannot assume responsibility for use of any circuitry other than circuitry entirely embodied in a Maxim product. No circuit patent licenses are implied. Maxim reserves the right to change the circuitry and specifications without notice at any time. The parametric values (min and max limits) shown in the Electrical Characteristics table are guaranteed. Other parametric values quoted in this data sheet are provided for guidance.

10 **Maxim Integrated Products, 120 San Gabriel Drive, Sunnyvale, CA 94086 408-737-7600**