

PREPARED BY: DATE

APPROVED BY: DATE

SHARP

LIQUID CRYSTAL DISPLAY GROUP
SHARP CORPORATION

SPECIFICATION

SPEC No. LC90531C

FILE No.

ISSUE 28. JUN. 1990

PAGE 23 Pages

REPRESENTATIVE DIVISION

Nara FACTORY

Tenri FACTORY

液晶之友 电话: 020-33819057
Http://www.lcdfriends.com

DEVICE SPECIFICATION for
640×480 Dot Graphic LCD Unit

Model No.

LM64P70

CUSTOMER'S APPROVAL

DATE _____

BY _____

PRESENTED

BY 

H. Uede

Department General Manager

Engineering Department 2

Nara FACTORY

LCD GROUP

SHARP CORPORATION

SHARP

MODEL No

LM64P70

RECORDS OF REVISION

DOC. FIRST ISSUE

28-JUN-1990

IDENT. DATA No

DATE	REF. PAGE PARAGRAPH DRAWING No	REVISED No	SUMMARY	CHECK & APPROVAL
A 16-JUL-1990	Page.17 Fig.10	△	Connector position:Addition	<i>[Signature]</i>
C 15.OCT.1990	Page.18	△	Page replaced	

SHARP**1. Application**

This data sheet is to introduce the specification of the Dot-Matrix LCD Unit LM64P70 .

2. Construction and Outline

Construction: 640×480 full dot graphic display unit consisting of an LCD panel, PWB (printed wiring board) with electric components mounted onto, TAB (tape automated bonding) to connect the LCD panel and PWB electrically, and plastic chassis with CCFT backlight and bezel to fix them mechanically.

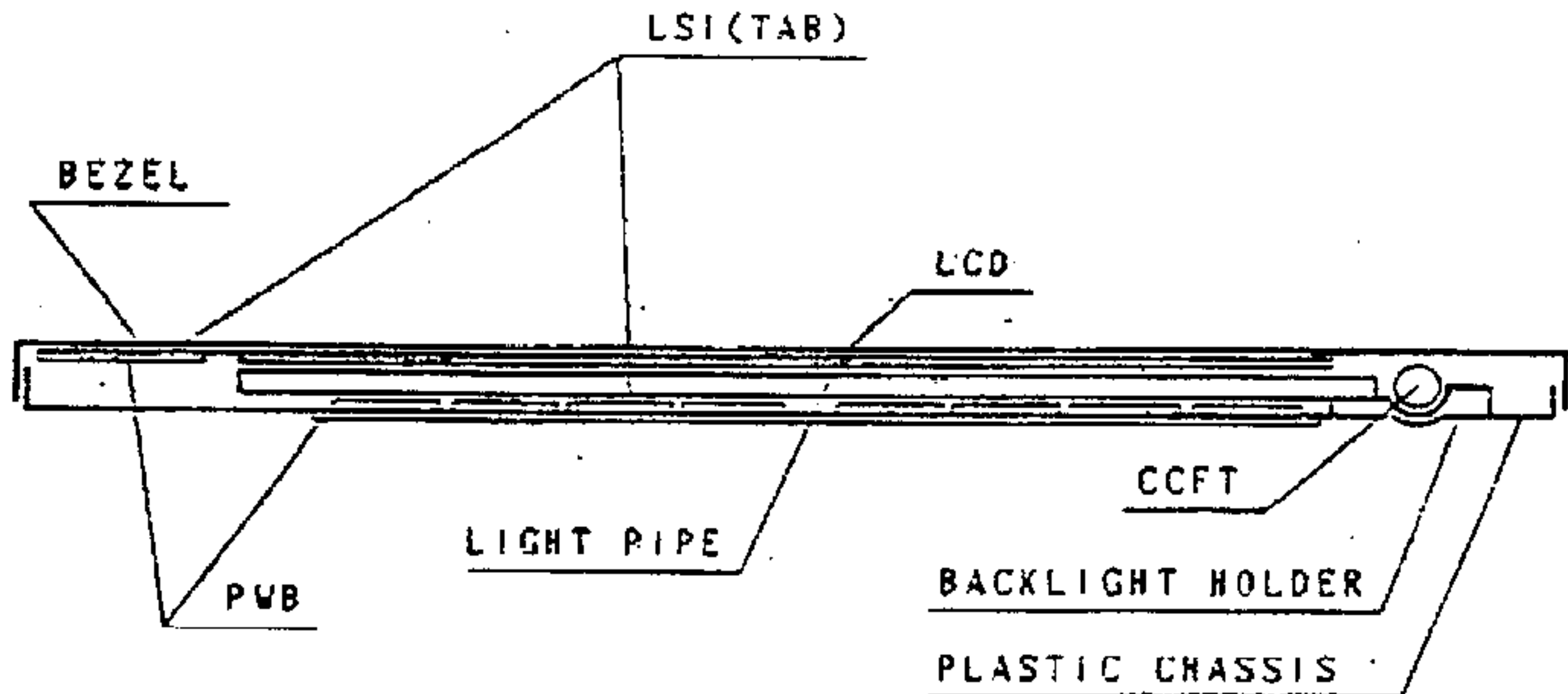

Outline : See Fig. 10

Connection : See Fig. 10 and Table 6

SHARP**3. Mechanical Specifications**Table 1

Parameter	Specifications	Unit
Outline dimensions	257 (W) × 153.5 (H) × 9.5 MAX (D)	mm
Effective viewing Area	180 (W) × 133 (H)	mm
Display format	640 (W) × 480 (H) full dot	—
Dot size	0.24 × 0.24	mm
Dot spacing	0.03	mm
*1 Dot color	White*2	—
*1 Background color	Black*2	—
Weight	Approx. 420	g

*1 Due to the characteristics of the LC material, the colors vary with environmental temperature.

***2 Negative-type display**

Displayed data "H": Dots ON : White

Displayed data "L": Dots OFF: Black

4. Absolute Maximum Ratings**4-1 Electrical absolute maximum ratings**Table 2

Parameter	Symbol	MIN.	MAX.	Unit	Remark
Supply voltage (Logic)	$V_{DD}-V_{SS}$	0	6.0	V	Ta=25°C
Supply voltage (LCD drive)	$V_{DD}-V_{EE}$	0	28.0	V	Ta=25°C
Input voltage	V_{IN}	0	V_{DD}	V	Ta=25°C

SHARP

4-2 Environmental Conditions

Table 3

Item	Tstg		Topr		Remark
	MIN.	MAX.	MIN.	MAX.	
Ambient temperatuer	-25℃	+60℃	0℃	+45℃	Note 4
Humidity	Note 1		Note 1		No condensation
Vibration	Note 2		Note 2		3 directions (X/Y/Z)
Shock	Note 3		Note 3		6 directions (±X±Y±Z)

Note 1) $T_a \leq 40^\circ\text{C}$95% RH Max

$T_a > 40^\circ\text{C}$Absolute humidity shall be less than $T_a=40^\circ\text{C}/95\%$ RH.

Note 2)

Frequency	5Hz~23Hz	23Hz~500Hz
Vibration level	—	1.0G
Vibration width	1.0mm	—
Interval	5Hz~500Hz~5Hz/26.6min	

2 hours for each direction of X/Y/Z (6 hours as total)

Note 3) Accerelation: 50G

Pulse width : 1ms

3 times for each direction of ± X / ± Y / ± Z

Note 4) Care should be taken so that the LCD Unit may not be subjected to the temperature out of this specification.

SHARP

5. Electrical Specifications

5-1 Electrical characteristics

Table 4 $T_a=25^\circ\text{C}, V_{cc}=5V\pm 10\%$

Parameter	Symbol	Conditions	Min.	Typ.	Max.	Unit
Supply voltage (Logic)	$V_{DD}-V_{SS}$	Note 1)	4.5	5.0	5.5	V
Supply voltage (LCD drive)	$V_{EE}-V_{SS}$	Note 2) Note 3)	-21.0	-16.2	-12.9	V
Input signal voltage	V_{IN}	"H" level	$0.8V_{cc}$	—	V_{cc}	V
		"L" level	0	—	$0.2V_{cc}$	V
Input leakage current	I_{IL}	"H" level	—	—	50	μA
		"L" level	-50	—	—	μA
Supply current (Logic)	I_{DD}	$V_{EE} = -16.2\text{V}$ $V_{DD} = 5\text{V}$	—	20	30	mA
Supply current (LCD drive)	I_{EE}	Frame frequency* 85Hz	—	15	25	mA
Power consumption	P_d	Display high frequency pattern	—	350	600	mW

Note 1) V_{cc} to be applied according to the specifications shall be regulated and sudden fluctuation of V_{cc} , even if the fluctuation is within the specifications, shall be strictly avoided.

Note 2) The viewing angle θ at which the optimum contrast is obtained can be set by adjusting $V_{EE}-V_{SS}$. Refer to Fig.4 for the definition of θ .

Note 3) Max. and Min. values are specified as the Max. and Min. voltage within the condition of operational temperature range ($0\sim 45^\circ\text{C}$). Typ. values are specified as the typical voltage at 25°C .

5-2 Input capacitance

Table 5

Signal	Input capacitance
S	40pF TYP
CP1	250pF TYP
CP2	200pF TYP
DU0~DU3	200pF TYP
DL0~DL3	200pF TYP

SHARP

5-3 Interface signals

Table 6

○LCD

Pin No	Symbol	Description	Level
1	S	Scan start-up signal	"H"
2	CP1	Input data latch signal	H→L
3	CP2	Data input clock signal	H→L
4	V _{DD}	Power supply for logic and LCD (+5V)	-
5	V _{SS}	Ground potential	-
6	V _{EE}	Power supply for LCD (-)	-
7	DU0	Display data signal (Upper half)	H (ON), L (OFF)
8	DU1		
9	DU2		
10	DU3		
11	DL0	Display data signal (Lower half)	H (ON), L (OFF)
12	DL1		
13	DL2		
14	DL3		

○CCFT

Pin No	Symbol	Description	Level
1	GND	Ground line (from Inverter)	-
2	NC	-	-
3	NC	-	-
4	HV	High voltage line (from Inverter)	-

Note) Pin No. and its location are shown in Fig. 10.

○LCD

Used connector: 52103-1417 (MOLEX)

Correspondable connector: 1mm Pitch FFC or FPC

Conductor width 0.7mm

length 2.7mm

○CCFT

Used connector: M62M83-04 (MITSUMI)

Correspondable connector: M60-04-30-114P (MITSUMI)

M60-04-30-134P (MITSUMI)

M61M73-04 (MITSUMI)

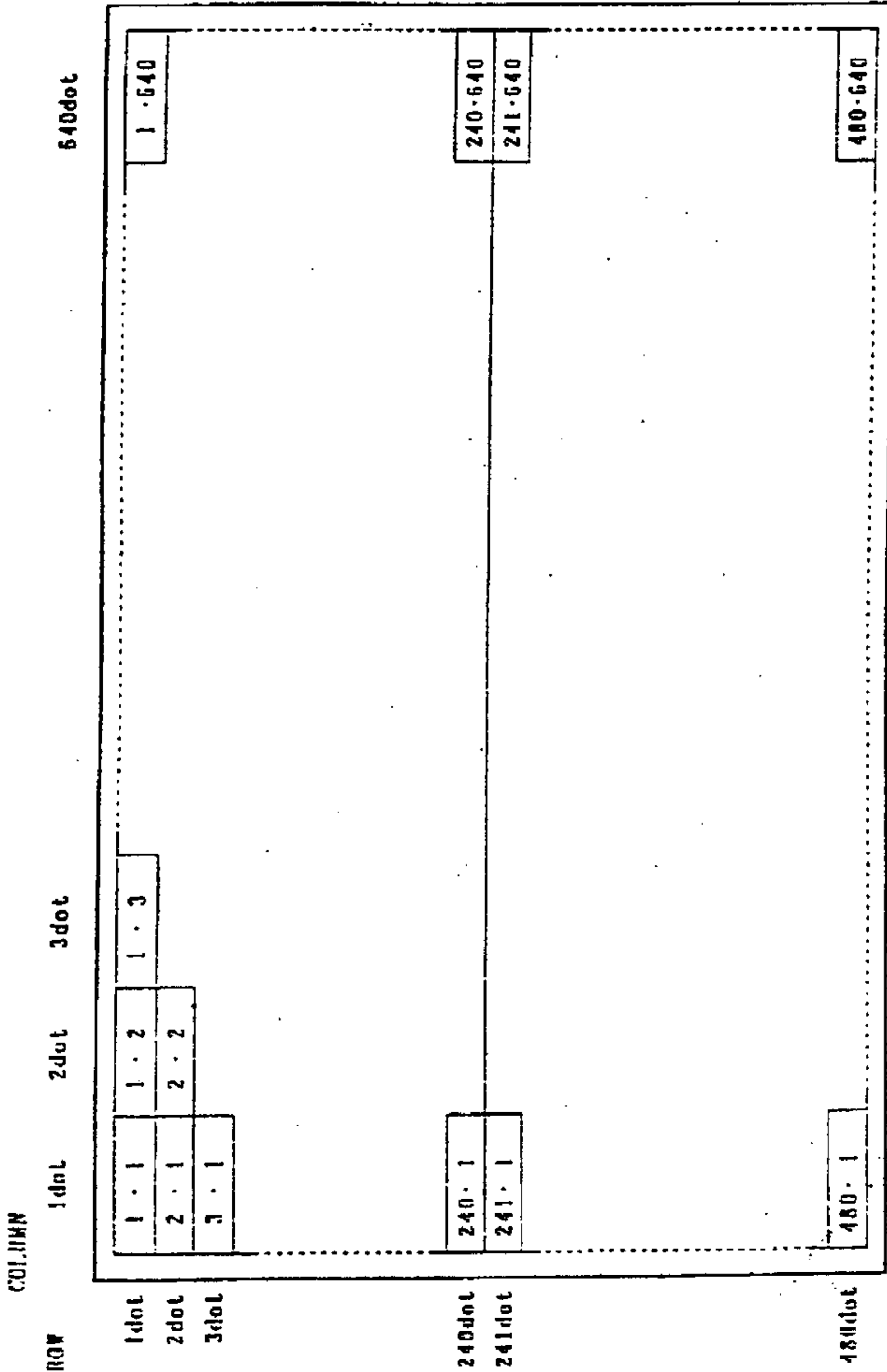

Note: 1.2 means 1st row 2nd column dot.

Fig. 1 Dot chart of display area

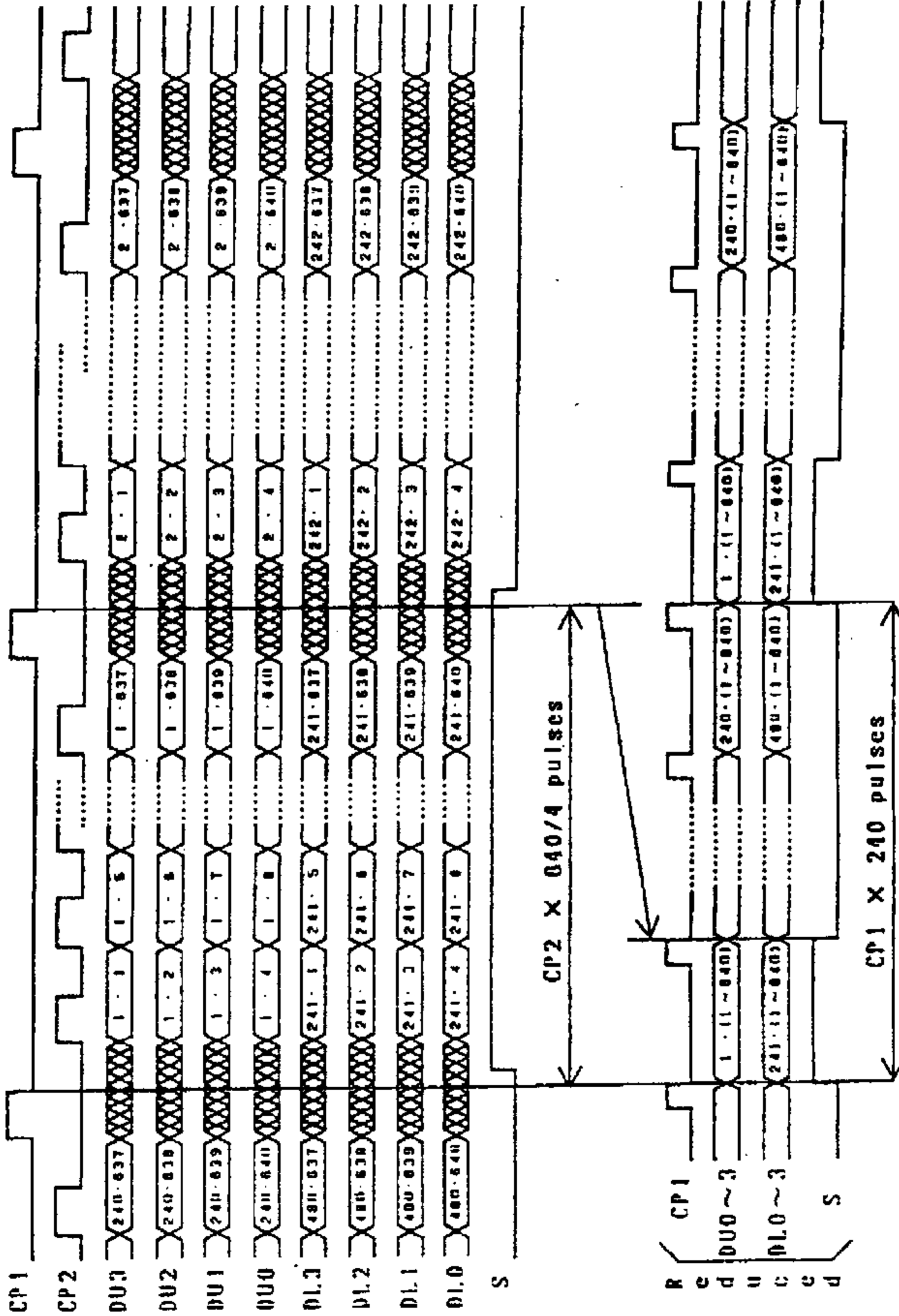

Fig. 2 Data Input timing

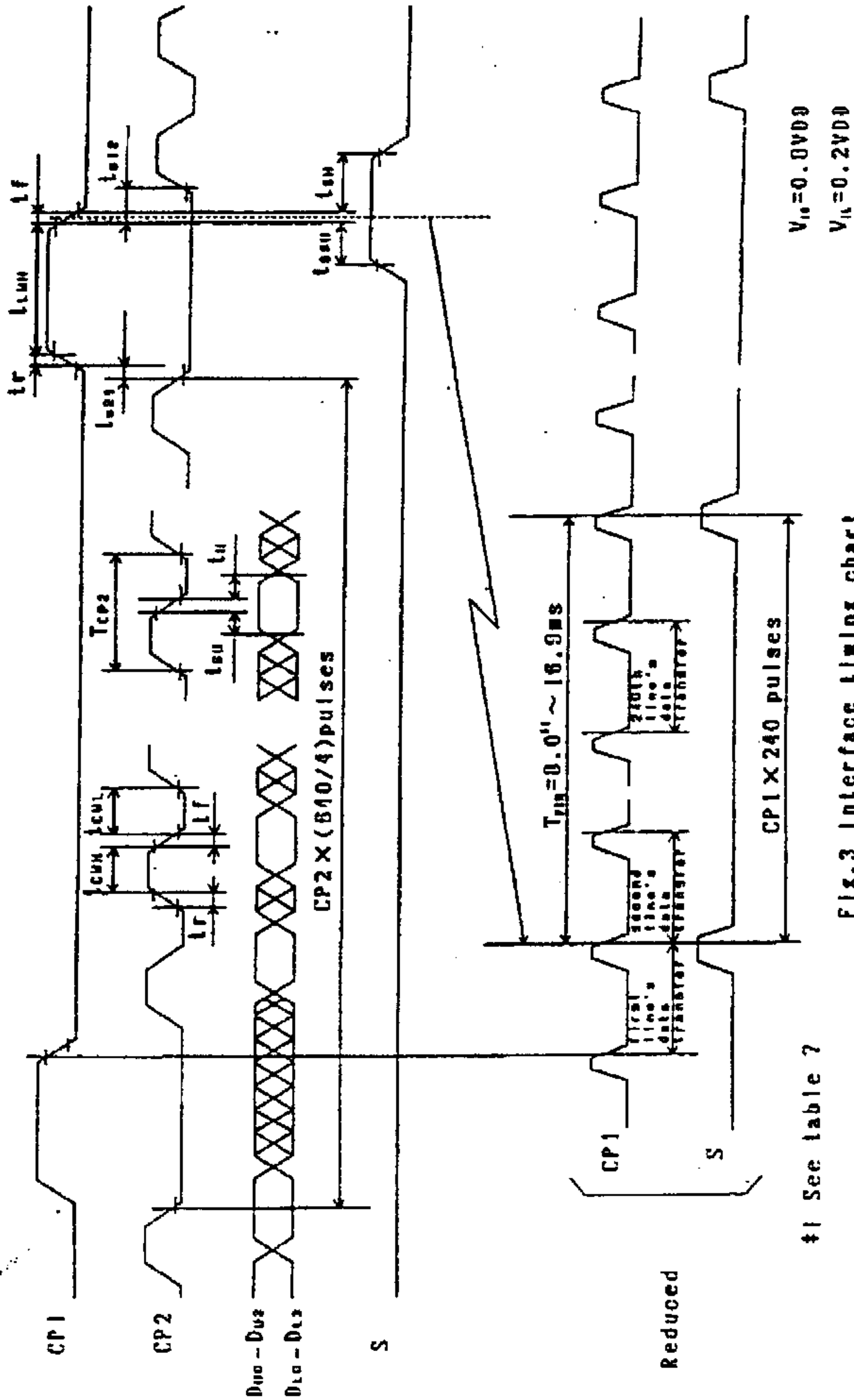

Fig.3 Interface timing chart

SHARP

Table 7 Interface timing ratings

Item	Symbol	Rating			Unit
		MIN.	TYP.	MAX.	
Frame cycle	T_{FRN}	8.0 ^{*1}		16.9	ms
CP2 clock cycle	T_{CP2}	166			ns
"H" level clock width	t_{CWH}	70			ns
"L" level clock width	t_{CWL}	70			ns
"H" level latch clock width	t_{LWH}	70			ns
Data set up time	t_{SU}	60			ns
Data hold time	t_H	40			ns
S set up time	t_{SSU}	100			
S hold time	t_{SH}	100			
CP2 ↑ clock allowance time from CP1 ↓	t_{S21}	0			ns
CP1 ↑ clock allowance time from CP2 ↓	t_{S12}	0			ns
Clock rise/fall time	$t_{r,tf}$			$t_{r,f}^{*2}$	ns

*1 : LCD unit functions at the minimum frame cycle of 8 ms (Maximum frame frequency of 125Hz). Owing to the characteristics of LCD unit, "shadowing" will become more eminent as frame frequency goes up, while flicker will be reduced.

According to our experiments, frame cycle of 11.7 ms Min. or frame frequency of 85 Hz Max. will demonstrate optimum display quality in terms of flicker and "shadowing". But since judgement of display quality is subjective and display quality such as "shadowing" is pattern dependent, it is recommended that decision of frame cycle or frame frequency, to which power consumption of the LCD unit is proportional, be made based on your own through testing on the LCD unit with every possible patterns displayed on it.

*2 : $t_{r,f} = 50$ in case $t_{cr} = (T_{CP2} - t_{CWH} - t_{CWL}) / 2 \geq 50$
 $t_{r,f} = t_{cr}$ in case $t_{cr} = (T_{CP2} - t_{CWH} - t_{CWL}) / 2 < 50$

SHARP

6. Unit Driving Method

6.1 Circuit configuration

Fig.9 shows the block diagram of the Unit's circuitry.

6.2 Display Face Configuration

The display face electrically consists of two (upper and lower) display segments so that the unit may offer higher contrast by reducing drive duty ratio. Each display segment (640×240 dots) is driven at 1/240 duty ratio.

6.3 Input Data and Control Signal

The LCD driver is 80 bits LSI, consisting of shift registers, latch circuits and LCD driver circuits.

Display data which are externally divided into data for each row (640dots) will be sequentially transferred in the form of 4-bit parallel data through shift registers by Clock Signal CP2 from the left top of the display face.

When data of one row (640dots) have been input, they will be latched in the form of parallel data for 640 lines of signal electrodes by latch signal CP1. Then the corresponding drive signal will be transmitted to the 640 lines of column electrodes of the LCD panel by the LCD drive circuits.

At this time, scan start-up signal S has been transferred from the scan signal driver to the 1st row of scan electrodes, and the contents of the data signals are displayed on the 1st rows of upper and lower half of the display face according to the combinations of voltages applied to the scan and signal electrodes of the LCD.

While the 1st rows of data are being displayed, the 2nd rows of data are entered. When 640 dots of data have been transferred then latched on the falling edge of CP1 clock, the display face proceeds to the 2nd rows of display.

Such data input will be repeated up to the 240th row of each display segment, from upper to lower rows, to complete one frame of display by time sharing method. Then data input proceeds to the next display face.

Scan start-up signal S generates scan signal to drive horizontal electrodes.

Since DC voltage, if applied to LCD panel, causes chemical reaction which will deteriorate LCD panel, drive waveform shall be inverted at every display frame to prevent the generation of such DC voltage. Control Signal M plays such role.

SHARP

Because of the characteristics of the CMOS driver LSI, the power consumption of the unit goes up as the operating frequency CP2 increases. Thus the driver LSI applies the system of transferring 4-bits parallel data through the 4 lines of shift registers to reduce the data transfer speed CP2. Thanks to the LSI, the power consumption of the unit will be minimized.

In this circuit configuration, 4-bit display data shall be therefore input to data input pins of DU_n-3 (upper display segment) and DL_n-3 (lower display segment).

Furthermore the LCD unit adopts bus line system for data input to minimize the power consumption. In this system data input terminal of each driver LSI activated only when relevant data input is fed.

Data input for column electrodes of both the upper and the lower display segment and chip select of driver LSI are made as follows:

The driver LSI at the left end of the display face is first selected, and the adjacent driver LSI of the right side is selected when 80 dots data (20CP2) is fed. This process is sequentially continued until data is fed to the driver LSI at the right end of the display face.

This process is simultaneously followed at the column drivers LSI's of both the upper and the lower display segments. Thus data input for both the upper and the lower display segments must be fed through 4-bit bus line sequentially from the left end of the display face.

Since this graphic display unit contains no refresh RAM, it requires data and timing pulse inputs even for static display.

The timing chart of input signals are shown in Fig. 3 and Table.7.

7. Optical Characteristics

$T_a=25^{\circ}C, V_{DD}=5.0V$

$V_{DD}-V_{EE}=V_{max}$

Table 8

Following spec are based upon the electrical measuring conditions, on which the contrast of perpendicular direction ($\theta_x=\theta_y=0$) will be MAX.

Parameter	Symbol	Condition	MIN.	TYP.	MAX.	Unit	Remark	
Viewing angle range	θ_x	$Co > 4.0$	$\theta_y=0$	-25	-	25	dgr.	Note 1
	θ_y		$\theta_x=0$	-10	-	20	dgr.	
Contrast ratio	Co	$\theta_x=\theta_y=0$	7	13	-	-	Note 2	
Response time	Rise	τ_r	$\theta_x=\theta_y=0$	-	250	350	μs	Note 3
	Decay	τ_d	$\theta_x=\theta_y=0$	-	150	250	μs	

Note 1) The viewing angle range is defined as shown Fig. 4.

Note 2) Contrast ratio is defined as follows:

$$Co = \frac{\text{Luminance (brightness) all pixels "white" at } V_{max}}{\text{Luminance (brightness) all pixels "dark" at } V_{max}}$$

V_{max} is defined in Fig. 6.

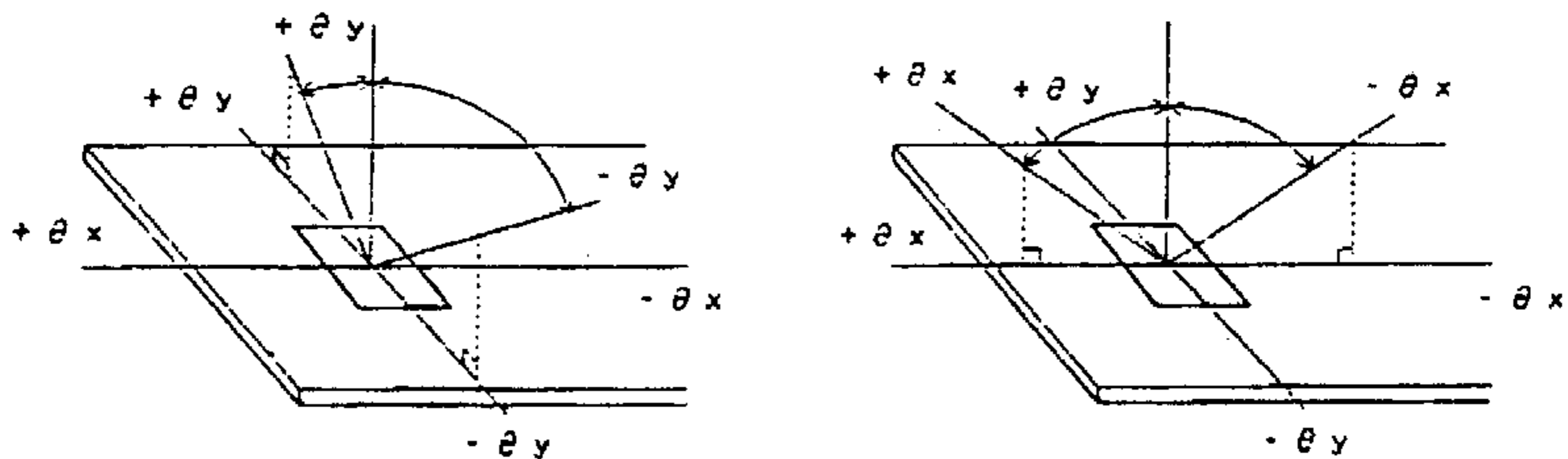

Fig.4 Definition of Viewing Angle

Note 3) The response characteristics of photo-detector output are measured as shown in Fig.7, assuming that input signals are applied so as to select and deselect the dots to be measured. in the optical characteristics test method shown in Fig.8.

SHARP

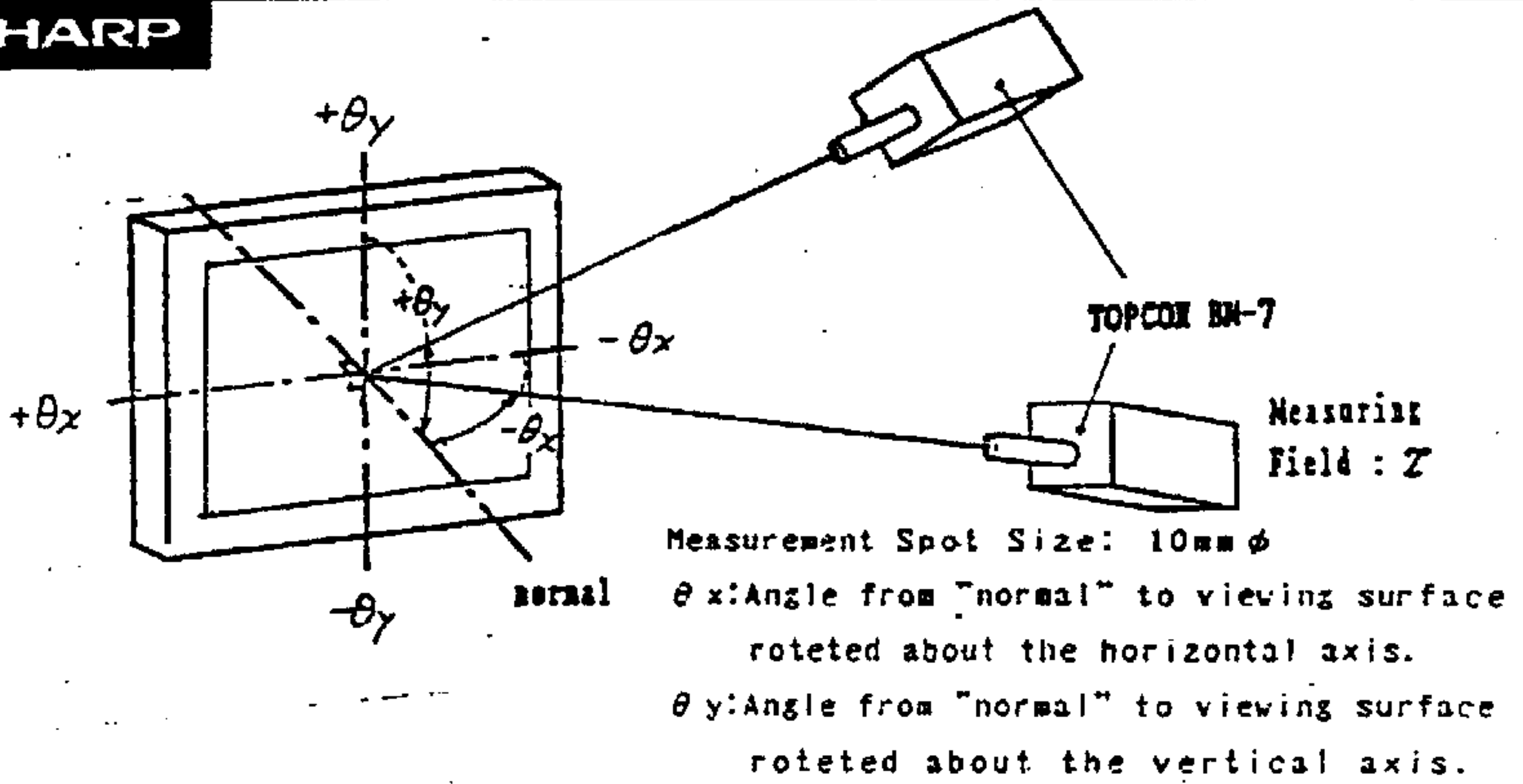

Fig.5 Optical Characteristics Test Method 1

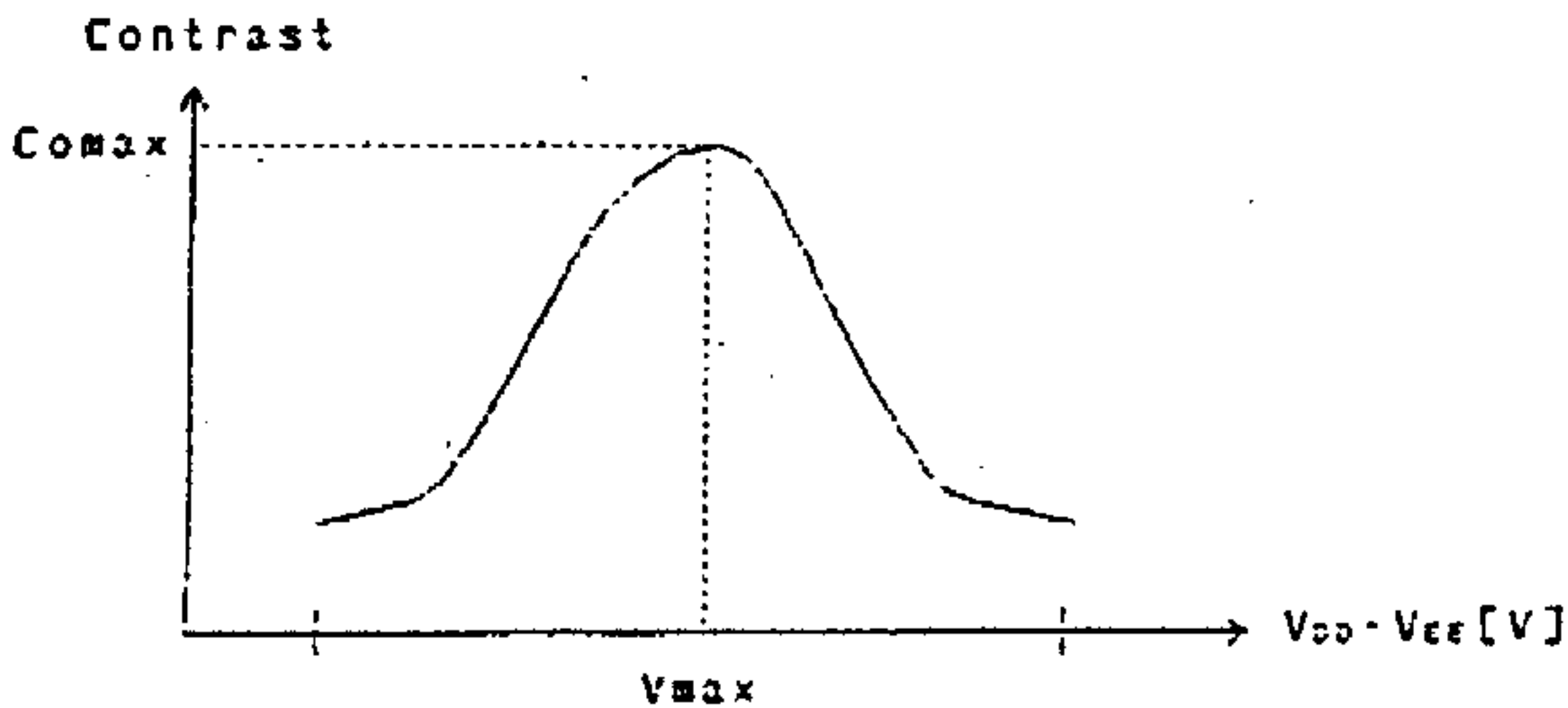

Fig.6 Definition of V_{max}

SHARP

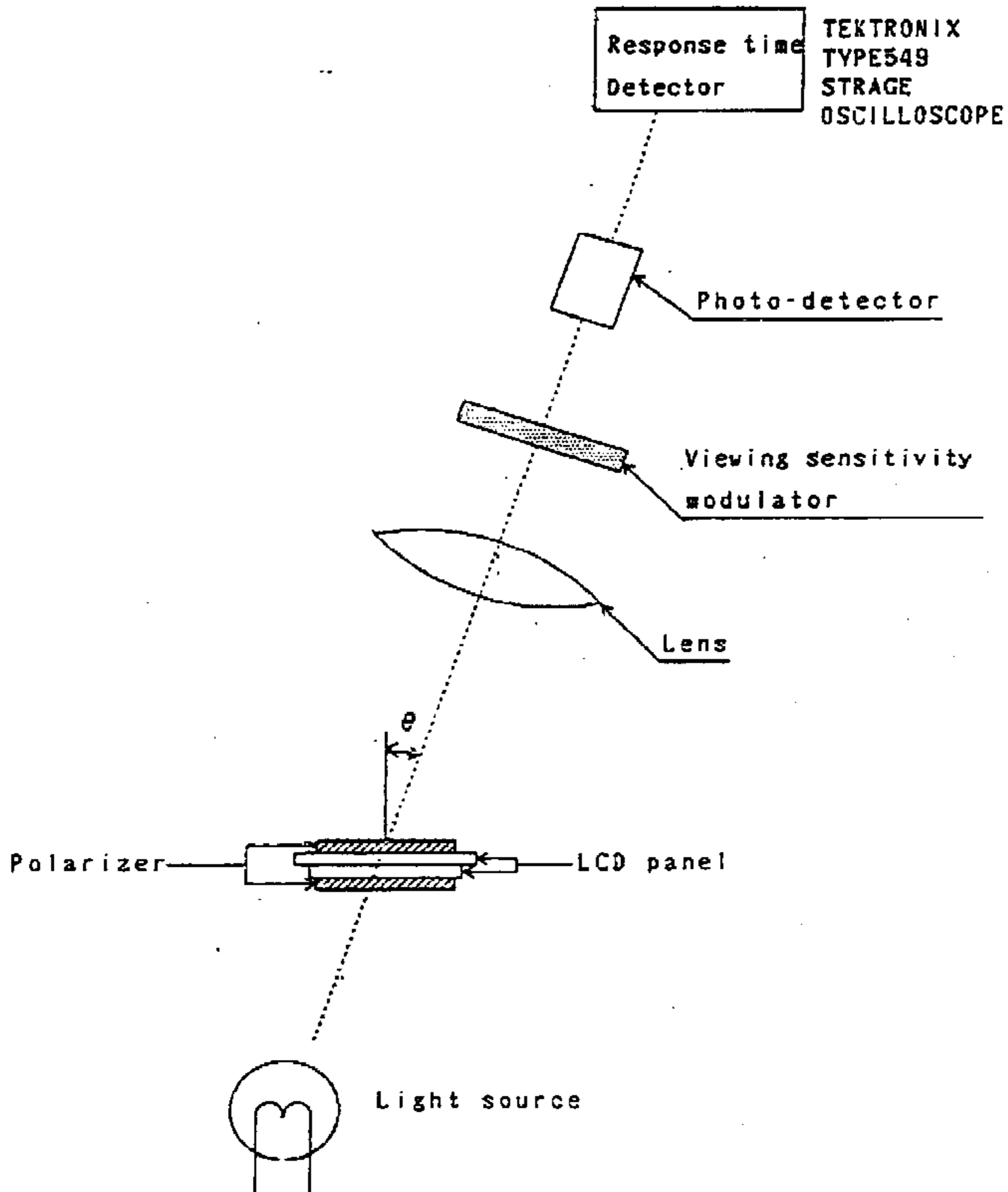

Fig.7 Optical Characteristics Test Method II

SHARP

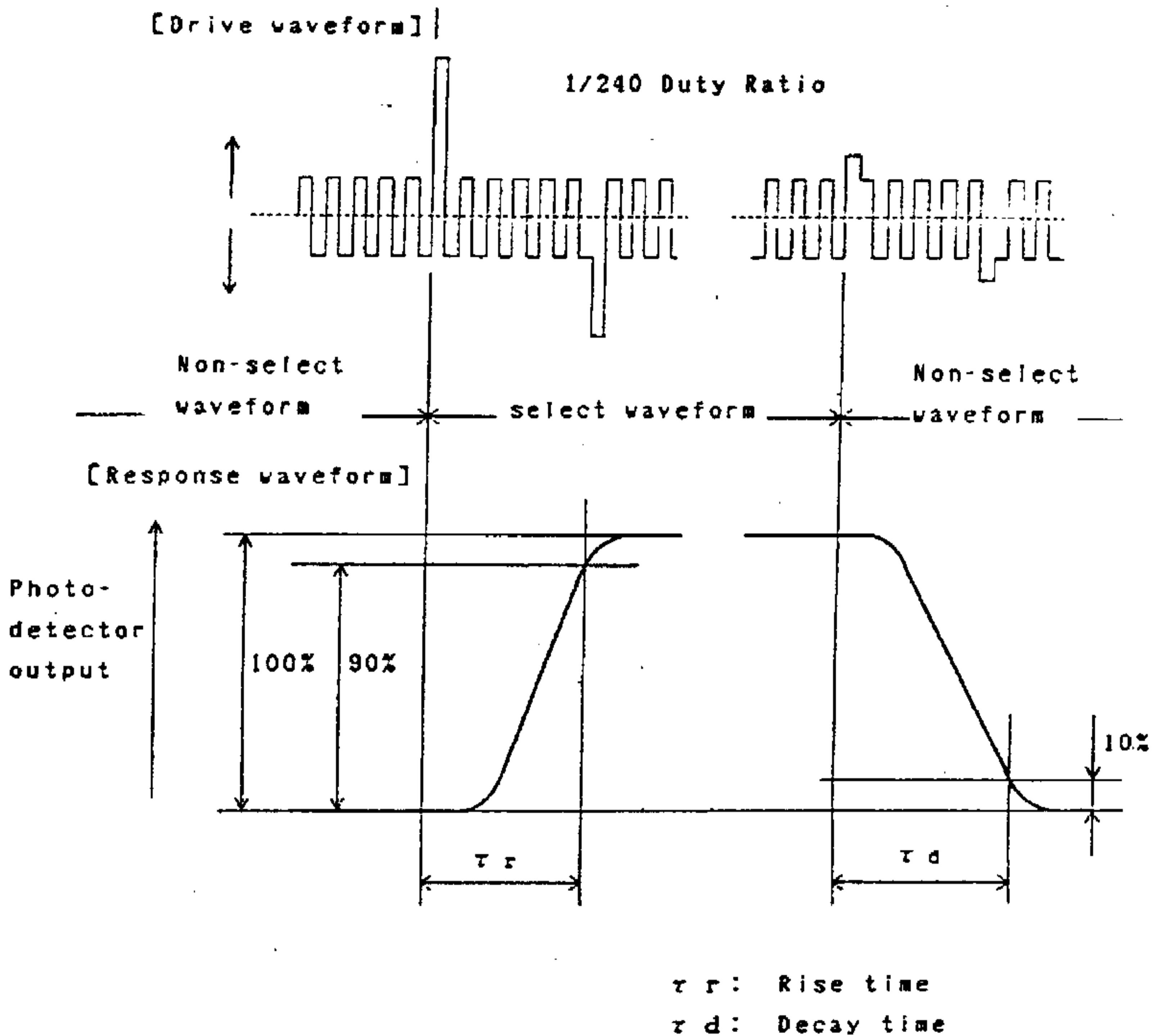
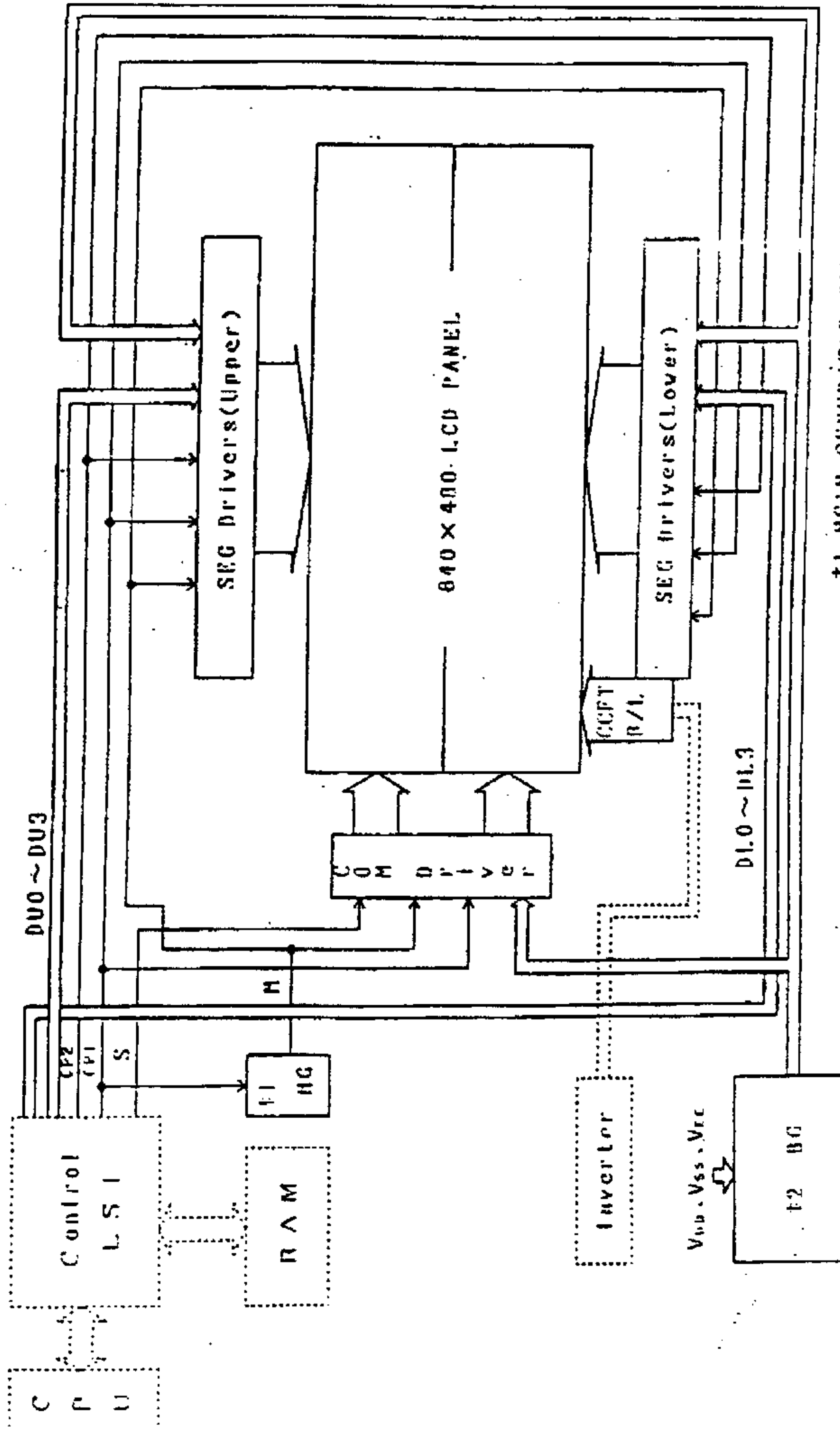
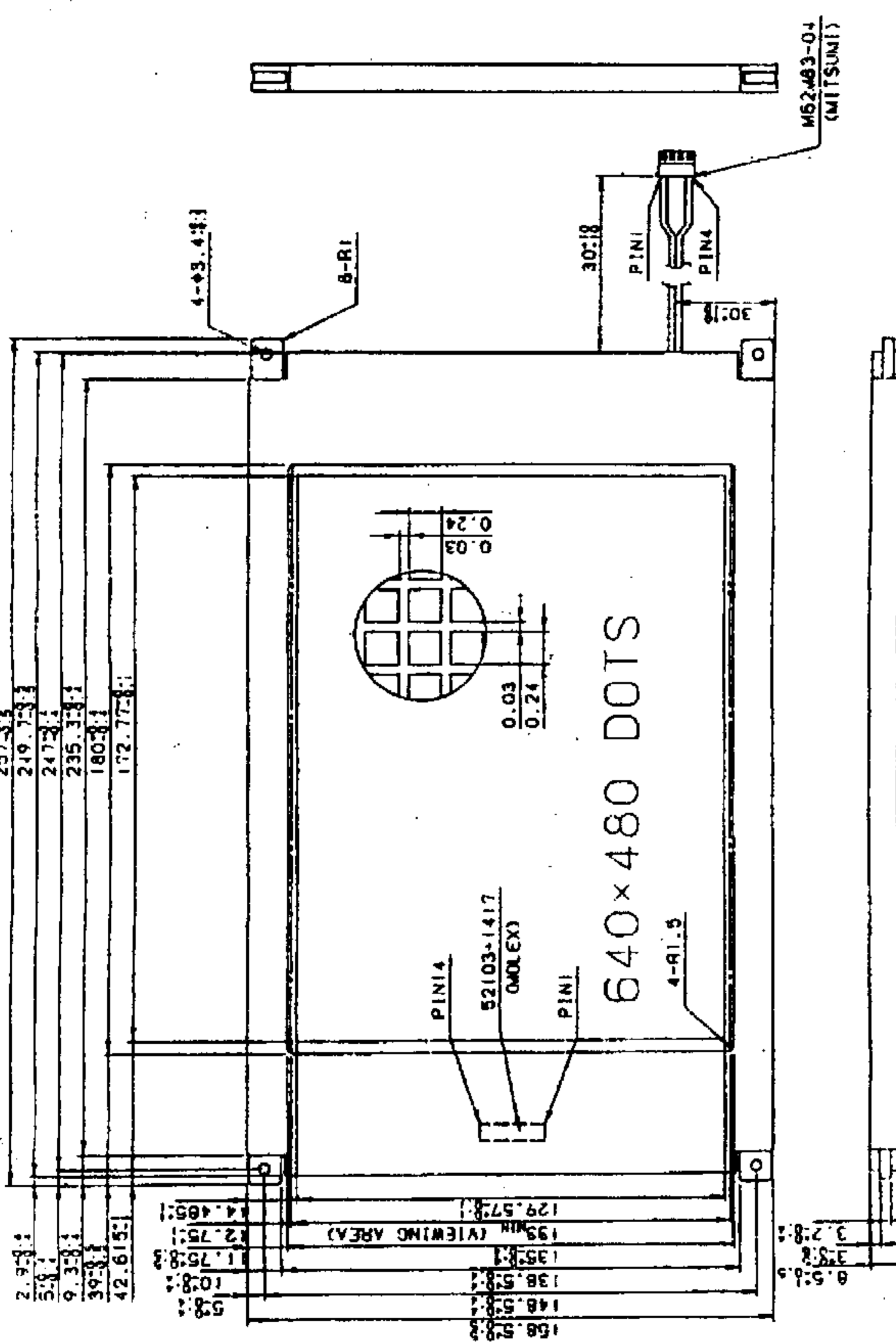

Fig.8 Definition of Response Time



#1 HIGH GENERATOR CIRCUIT
#2 BG:BIAS VOLTAGE GENERATOR CIRCUIT

Fig. 9 Circuit block diagram



表示寸法公差は JIS B 1301 による		LCD UNIT	
品名	LM64P70	寸法	640x480
仕様	640x480 DOTS	材質	ガラス
製造	SHARP CORPORATION	製造	日本
検査	検査済	検査	合格
承認	承認済	承認	合格
出図	出図済	出図	合格

Fig. 10

△ This page was replaced.

SHARP

Characteristics of Backlight

The ratings are given on condition that the following conditions are satisfied.

1. Rating (NOTE)

Parameter	Min	Typ	Max	Unit
Brightness	25	35	-	nit

2. Measurement circuit: LM000106 (SHARP) (at $I_L=5mA_{ac}$)

3. Measurement equipment: BM-7 (TOPCON Corporation)

4. Measurement conditions

4-1 Measurement circuit voltage: DC=12V at primary side

4-2 LCD: All digits WHITE. VDD=5V, VDD-VEE= V_{max} . DU0~DU3

(refer Fig. 6) DL0~DL3="H" (WHITE)

4-3 Ambient temperature: 25°C

Measurement shall be executed 30 minutes after turning on.

5. Used lamp: FLE48147 (AE) B. 1pcs.

5-1 Ratings (1pc)

Parameter		Max. allowable value
Circuit voltage (VS)	1100V _{rms} MIN	1500V _{rms}
Serial resistor (RS)	-	-
Discharging tube current (IL)	3.5~7mA _{ac} *	7mA _{ac}
Power consumption	2W	-
Discharging tube voltage (VL)	280V _{rms} TYP	-
Brightness (B)	10,000nit TYP	-

Within no conductor closed.

- * It is recommended that I_L be not more than 5mA_{ac} so that heat radiation of CCFT backlight may least affect the display quality.

5-2 Operating life

The operating life time is 10,000 hours or more at 5mA.

(5,000 hours or more at 7mA.)

(Operating life with SHARP LM000106 or equivalent)

The inverter should meet the following conditions:

-Sine, symmetric waveform without spike in positive and negative.

SHARP

- The voltage at the secondary side is 1100Vac or more.
- Illuminance frequency is from 25 to 45KHz

The operating life-time is defined as having ended when any of the following conditions occur: ($25 \pm 5^\circ\text{C}$)

- When the voltage required for initial discharge has reached 80% of the specified or when it has reached 10v-DC when used an inverter.
- When the illuminance or quantity of light has decreased to 50% of the initial value.

(NOTE) Rating are defined as the average brightness inside the viewing area specified in Fig.A.

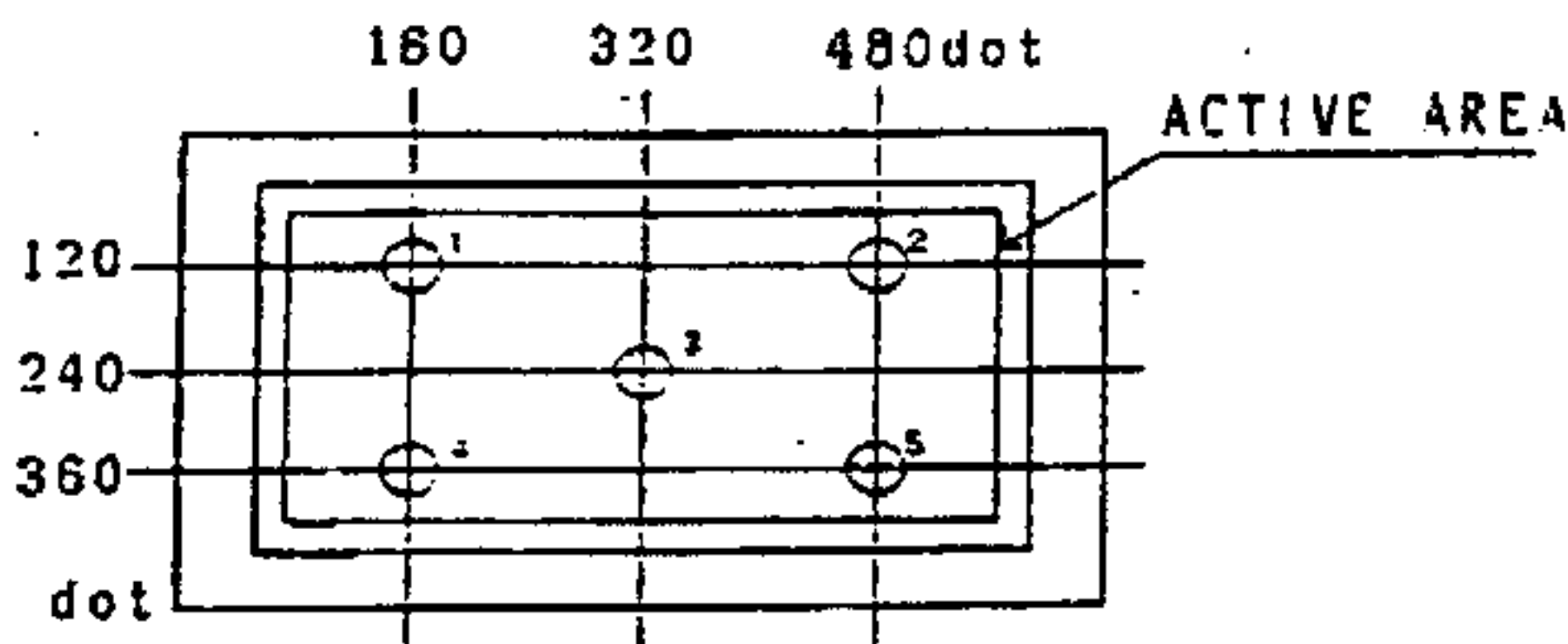

Fig.A Measureing points(1~5)

SHARP**8. Precautions**

- 1) Industrial (Mechanical) design of the product in which this LCD unit will be incorporated must be so made that the viewing angle characteristics of the LCD may be optimized.

This unit's viewing angle is illustrated in Fig. B.

$$\theta_{ymin} < \text{viewing angle} < \theta_{ymax}$$

(For the specific values of θ_{ymin} , θ_{ymax} , refer to the table 8.)

Please consider the optimum viewing conditions according to the purpose when installing the unit.

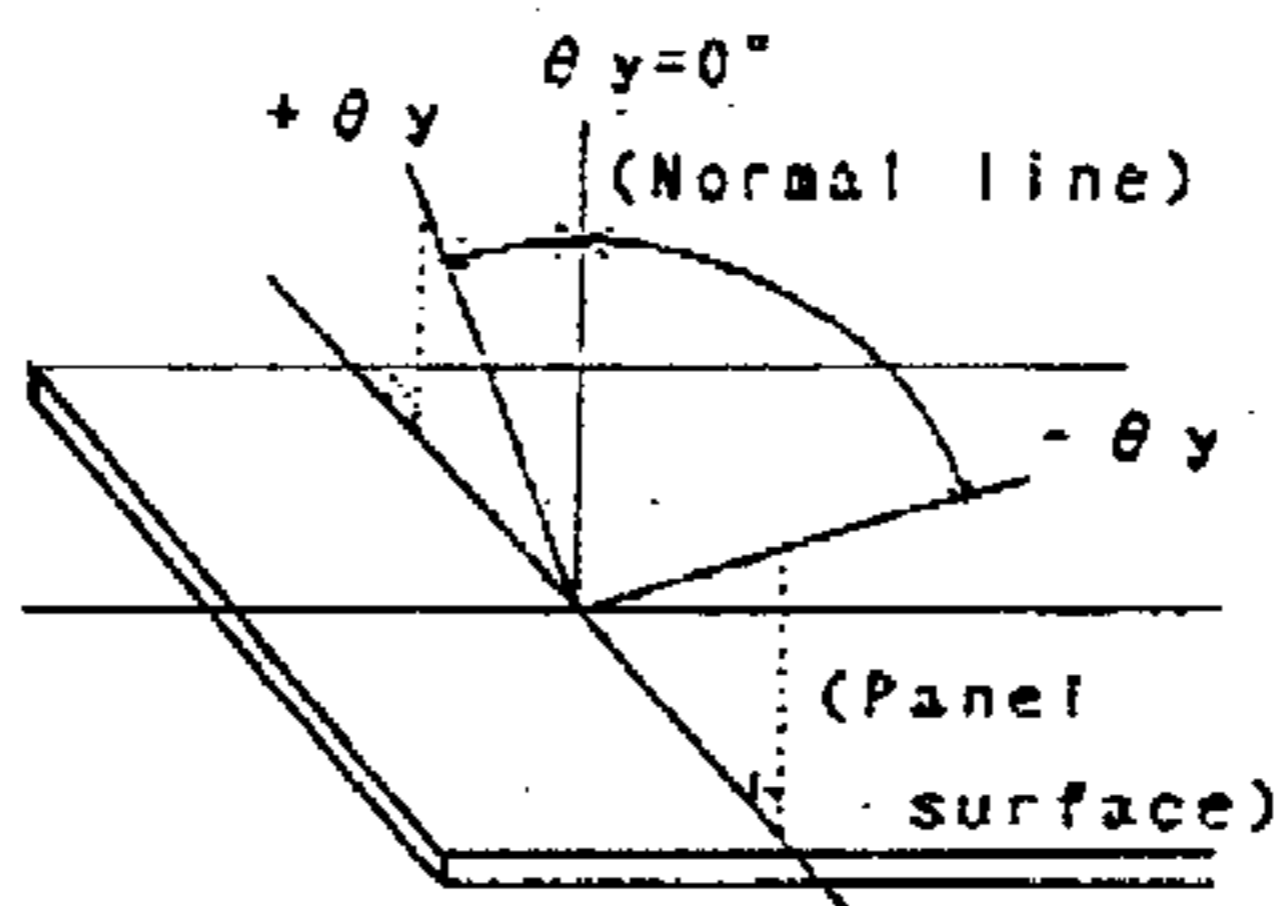

Fig. B Dot matrix LCD viewing angle

- 2) This unit is installed using mounting tabs at the four corners of PCB or bezel.

When installing the unit, pay attention and handle carefully not to allow any undue stress such as twist or bend.

A transparent acrylic resin board or other type of protective panel should be attached to the front of the unit to protect the polarizer, LCD cells, etc.

SHARP

- 3) Since the front polarizer is easily damaged, please pay attention not to scratch on its face.
- 4) If the surface of the LCD cells needs to be cleaned, wipe it swiftly with cotton or other soft cloth. If still not completely clear, blow on its and wipe.
- 5) Water droplets, etc. must be wiped off immediately since they may cause color changes, staining, etc. if remained for a long time.
- 6) Since LCD is made of glass plates, dropping the unit or banging it against hard objects may cause cracking or fragmentation.
- 7) CMOS LSIs are equipped in this unit, so care must be taken to avoid the electro static charge, by earthing human body, etc. Take the following measures, to protect the unit from the electric discharge via mounting tabs from the main system the electrified with static electricity.
 - (1) Earth the metallic case of the main system (contact of the unit and main system).
 - (2) Insulate the unit and main system by attaching insulating washers made of bakelite or nylon, etc.
- 8) The unit should be driven, according to the specified ratings to avoid malfunction of permanent damage. DC voltage drive leads to rapid deterioration of LC, so ensure that the drive is alternating waveform by continuous application of the signal M. Especially the power ON/OFF sequence shown on next page is strongly recommended to avoid latch-up of driver LSIs and application of DC voltage to LCD panel.
- 9) Avoid to expose the unit to the direct sun-light, strong ultra-violet light, etc. for a long time.
- 10) If stored at temperatures below specified storage temperature, the LC may freeze and be deteriorated. If storage temperature exceed the specified rating, the molecular orientation of the LC may change to that of a liquid, and they may not revert to their original state. As far as possible always store at normal room temperature.
- 11) Disassembling the LCD unit can cause permanent damage and should be strictly avoided.

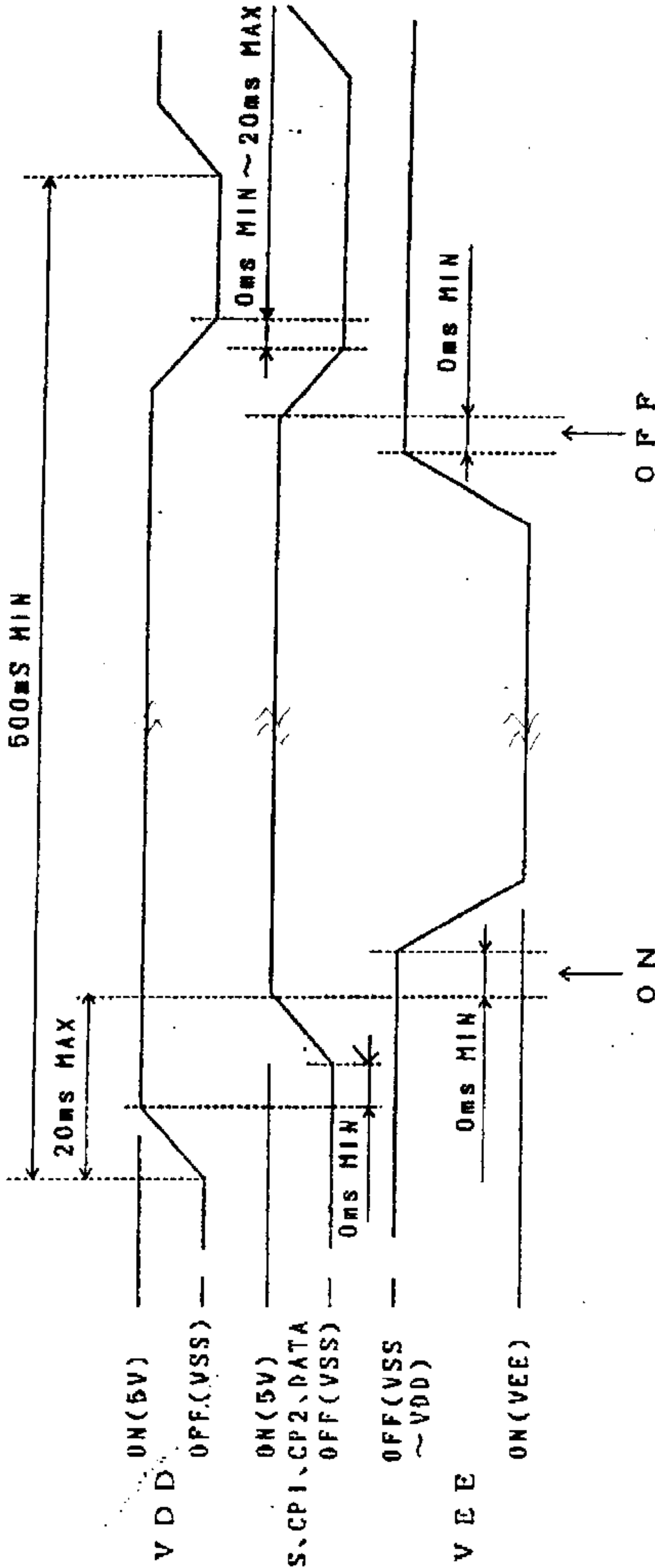

Recommended power ON/OFF sequence

SHARP**9. Applicable inspection standard**

The LCD unit shall meet the following inspection standard

:S-U-012-01

10. This specification describes display quality in case of no gray scale. Since display quality can be affected by gray scale methods, display quality shall be carefully evaluated for the usability of the LCD UNIT in case gray scale is displayed on the LCD UNIT.

WARNING

DON'T USE ANY MATERIALS WHICH EMIT FOLLOWING GAS FROM EPOXY RESIN (AMINES' HARDENER) AND SILICONE ADHESIVE AGENT (DEALCOHOL OR DEOXYM) TO PREVENT CHANGE POLORIZER COLOR OWING TO GAS.

COCOM

THIS PRODUCT FALLS UNDER "STRATEGIC PRODUCT" ACCORDING TO THE EXPORT TRADE CONTROL ORDINANCE IN FORCE.

AND EXPORT OF THE ITEM REQUEST AN EXPORT LICENSE ISSUED BY THE RELATED AUTHORITIES.

PLEASE CONFIRM US WHETHER THE LICENSE IS NECESSARY SINCE THE ORDINANCE MAY BE REVISED BY THE AUTHORITIES.