

TB2924AFG

Class D, 20 W × 2-channel (BTL) Low-Frequency Power Amplifier IC

The TB2924AFG is an audio output IC that employs the highly efficient class D method, developed for TV and home audio applications.

The TB2924AFG eliminates the need for heatsink^(Note), thus allowing the design of an end product with a small footprint. It also incorporates a range of features, such as standby and muting, as well as different protective circuits.

Features

- Output: P_{OUT} = 13 W × 2ch (typ.) BTL
V_{CC} = 12 V, R_L = 4 Ω, THD = 10%, f = 1 kHz
P_{OUT} = 7.5 W × 2ch (typ.) BTL
V_{CC} = 12 V, R_L = 8 Ω, THD = 10%, f = 1 kHz
P_{OUT} = 19.5 W × 2ch (typ.) BTL
V_{CC} = 15 V, R_L = 4 Ω, THD = 10%, f = 1 kHz
P_{OUT} = 21 W × 2ch (typ.) BTL
V_{CC} = 20 V, R_L = 8 Ω, THD = 10%, f = 1 kHz
- High efficiency: When output is 10 W $\eta = 88\%$ (V_{CC} = 15 V, R_L = 8 Ω)
- Distortion: 0.1% (1 W output, f = 1 kHz)
- Gain: 34dB (typ.)
- Small flat package: HSOP36-P-450-0.65
- Muting/standby features
- Thermal AGC features
- Master and slave oscillation frequencies
- Oscillation frequency: f_{sw} = 200 kHz (typ.)
- Operating supply voltage range (4 Ω): V_{CC} (opr) = 11 V to 18 V (T_{opr} = 0°C to 75°C),
V_{CC} (opr) = 11.4 V to 18 V (T_{opr} = -20°C to 75°C)
- Operating supply voltage range (8 Ω): V_{CC} (opr) = 11 V to 20 V (T_{opr} = 0°C to 75°C),
V_{CC} (opr) = 11.4 V to 20 V (T_{opr} = -20°C to 75°C)
- Protective circuits: thermal shutdown, short-circuit protection (load)

These protection functions are intended to avoid some output short circuits or other abnormal conditions temporarily.

These protect functions do not warrant to prevent the IC from being damaged.

In case of the product would be operated with exceeded guaranteed operating ranges, these protection features may not operate and some output short circuits may result in the IC being damaged.

The TB2924AFG does not contain protection circuitry for shorts against V_{CC} and ground. Extra cares, such as inserting fuses, should be exercised when output pins serve as line output or adjacent pins are shorted together on the board.

Note: Generally, the average power of the audio signal constitutes only one-fifth to one-tenth of the maximum output power, and in practice, will not exceed the permissible loss. However, care should be exercised so that it will not be really exceeded, considering the board's thermal resistance, ambient temperature, average output power and so forth. Toshiba has verified that the TB2924AFG works properly without a heatsink on the Toshiba PC board for up to 10-watt by 2-channel output typical (V_{CC} = 15 V, R_L = 8 Ω, THD = 10%, f = 1 kHz) with a sine-wave input.

- This product are sensitive to electrostatic discharge. When handling this product, protect the environment to avoid electrostatic discharge.(MM: ±200 V OK, HBM: ±1500 V OK)
- Install the product correctly. Otherwise, it may result in break down, damage and/or degradation to the product or equipment.

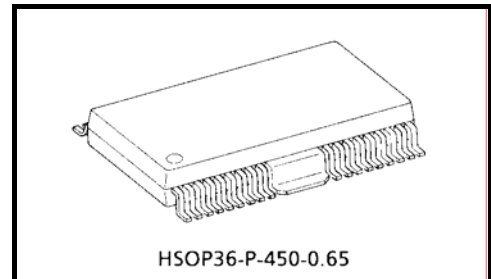

Weight: 0.85 g (typ.)

Pin Assignment and Block Diagram

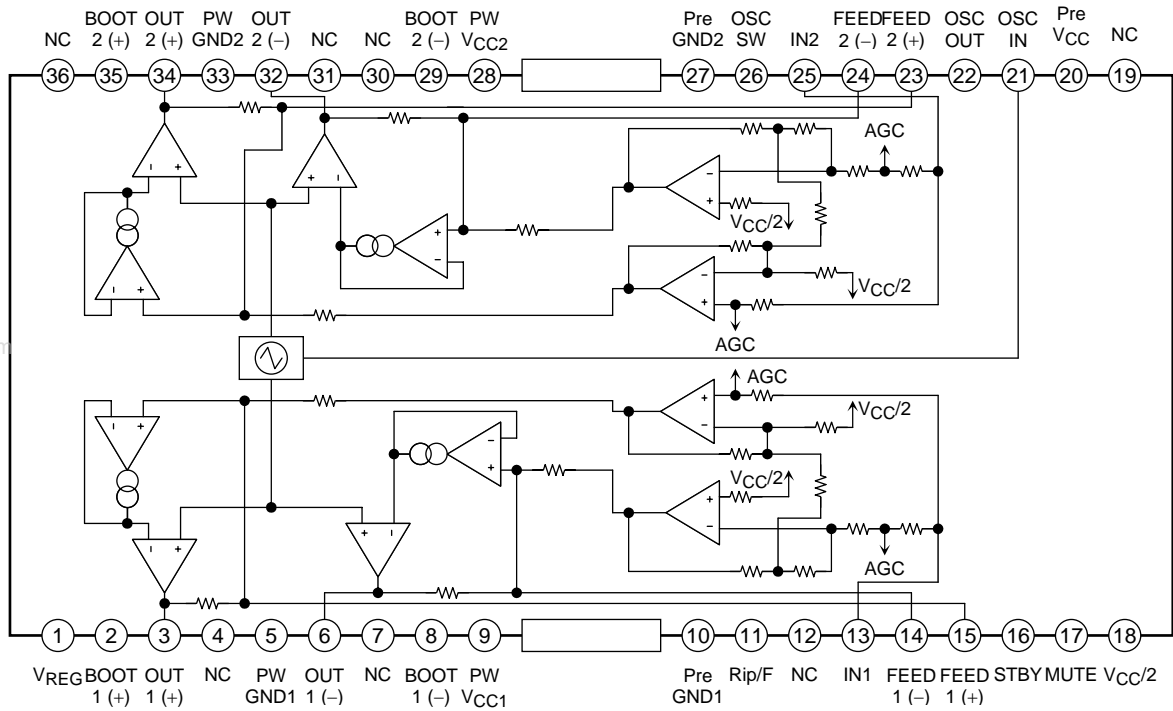

*: Some of the functional blocks, circuits, or constants in the block diagram may be omitted or simplified for explanatory purpose.

Pin Functions

Pin No.	Symbol	Description
1	V _{REG}	Reference supply voltage
2	BOOT1 (+)	CH1 bootstrap pin (+)
3	OUT1 (+)	CH1 main amplifier output pin (+)
4	NC	No-connection pin (not connected inside the IC)
5	PW GND1	GND for CH1 main amplifier output stage
6	OUT1 (-)	CH1 main amplifier output pin (-)
7	NC	No-connection pin (not connected inside the IC)
8	BOOT1 (-)	CH1 bootstrap pin (-)
9	PW V _{CC1}	Power supply pin for CH1 main amplifier output stage
10	Pre-GND1	Signal GND
11	Rip/F	Ripple filter pin
12	NC	No-connection pin (not connected inside the IC)
13	IN1	CH1 main amplifier input pin
14	FEED1 (-)	CH1 main amplifier feedback pin (-)
15	FEED1 (+)	CH1 main amplifier feedback pin (+)
16	STBY	Standby control pin
17	MUTE	Muting control pin
18	V _{CC/2}	Midpoint potential pin
19	NC	No-connection pin (not connected inside the IC)
20	Pre V _{CC}	Signal power supply pin
21	OSC IN	PWM oscillation frequency input pin
22	OSC OUT	PWM oscillation frequency output pin
23	FEED2 (+)	CH2 main amplifier feedback pin (+)
24	FEED2 (-)	CH2 main amplifier feedback pin (-)
25	IN2	CH2 main amplifier input pin
26	OSC SW	Oscillator on/off switch pin
27	Pre-GND2	Signal GND
28	PW V _{CC2}	Power supply pin for CH2 main amplifier output stage
29	BOOT2 (-)	CH2 bootstrap pin (-)
30	NC	No-connection pin (not connected inside the IC)
31	NC	No-connection pin (not connected inside the IC)
32	OUT2 (-)	CH2 main amplifier output pin (-)
33	PW GND2	GND for CH2 main amplifier output stage
34	OUT2 (+)	CH2 main amplifier output pin (+)
35	BOOT2 (+)	CH2 bootstrap pin (+)
36	NC	No-connection pin (not connected inside the IC)

Supplementary Explanation

<Control switches>

1. Pin 17 (muting switch)

- Enable or disable audio muting.
- The input amplifier is switched to a dummy amplifier within the IC, so that the audio output is muted with the amplifier still operating (PWM switched operation with 50% duty ratio).
- Pin 17 outputs a voltage of approximately 2.4 V (approx. 4 V_F) when open, while V_{TH} for the built-in switch is lower than 1.8 V. Leaving the pin open, therefore, disables muting.
- Logic
 “H” or open: Demute
 “L” (GND): Mute on

www.DataSheet4U.com

2. Pin 16 (standby switch)

- When the voltage on pin 16 becomes 1.8 V or higher, the bias circuit activates, enabling the IC to operate.
- Logic
 “H”: IC active
 “L” (GND): IC standby on

<Others>

3. Thermal AGC Function and Thermal Shutdown Circuit

- If the chip temperature exceeds the junction temperature (150°C min.), the thermal AGC function attenuates the input signal to maintain the chip temperature below the junction temperature.
- If the chip temperature further increases, the thermal shutdown circuit activates. The chip recovers from the thermal shutdown state once the chip temperature falls below the junction temperature.

4. Master and Slave Oscillation Frequencies (OSC IN, OSC OUT, OSC SW)

- When configuring a multichannel amplifier system with three or more channels, the oscillation frequency for a single IC can be used as a master and supplied to other ICs to prevent a beat due to a difference among switching frequencies. (Max. 6ch (3ICs))
- The oscillators for slave ICs should be turned off using the OSC SW pin.
 “H”: Turn the oscillator on
 “L” (GND): Turn the oscillator off

(Example with multiple ICs)

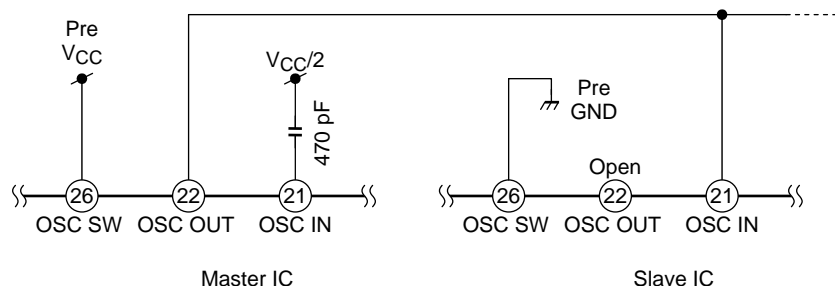

5. Reduction of Pop Noise Generated when Turning on and Off the Power Supply

- To reduce pop noise, it is recommended to enable muting by setting pin 17 (mute switch) to logic low before turning on or off the power supply or standby mode.

When turning on or off the standby mode (When the power supply is not turned on or off)

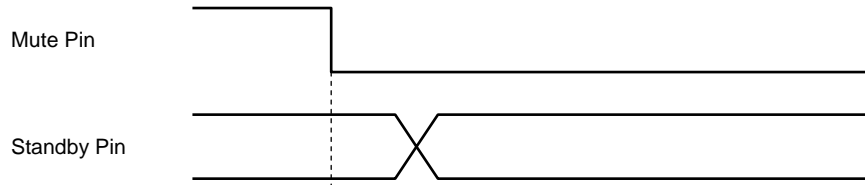

Turn on or off the standby mode after turning on muting.

When the power supply is off

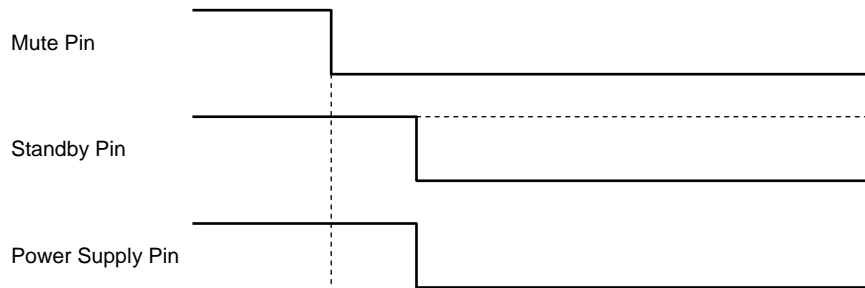

Turn off the power supply after turning on muting.
Don't turn off the standby mode before turning off the power supply.

When the power supply is on

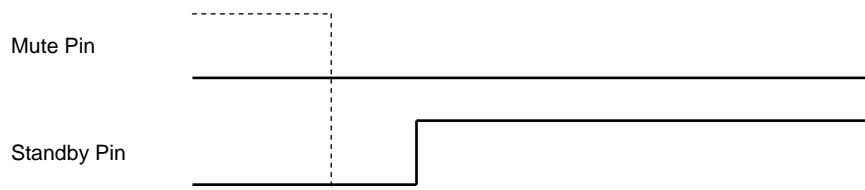

Turn on the power supply after turning on muting.

Timing charts may be simplified for explanatory purpose.

6. Board Mounting Consideration

The switching of the TB2924AFG is controlled with a rectangular-wave signal of approximately 200 kHz (typical). It is recommended to place the TB2924AFG far from the tuner portion, etc. that might be affected.

Absolute Maximum Ratings (Ta = 25°C)

Characteristics	Symbol	Rating	Unit
Power supply	V _{CC}	23	V
Output current	I _{o(peak)}	8	A
Power dissipation	P _D	14.7 (Note)	W
Operating temperature	T _{opr}	-20 to 75	°C
Storage temperature	T _{stg}	-55 to 150	°C

Note: When the IC is used at 25°C or higher with infinite heat sink, reduce 117.6 mW per 1°C.

The absolute maximum ratings of a semiconductor device are a set of specified parameter values, which must not be exceeded during operation, even for an instant.

If any of these rating would be exceeded during operation, the device electrical characteristics may be irreparably altered and the reliability and lifetime of the device can no longer be guaranteed.

Moreover, these operations with exceeded ratings may cause break down, damage and/or degradation to any other equipment.

Applications using the device should be designed such that each absolute maximum rating will never be exceeded in any operating conditions.

Before using, creating and/or producing designs, refer to and comply with the precautions and conditions set forth in this documents.

Electrical Characteristics 1

(unless otherwise specified, $V_{CC} = 15\text{ V}$, $f = 1\text{ kHz}$, $R_g = 600\ \Omega$, $R_L = 8\ \Omega$, $T_a = 25^\circ\text{C}$)

Characteristics	Symbol	Test Circuit	Test Condition	Min	Typ.	Max	Unit
Quiescent supply current	I_{CCQ}	1	$V_{in} = 0$	—	55	70	mA
Output power	P_{OUT} (1)	1	THD = 10%	9	10.5	—	W
	P_{OUT} (2)	1	$V_{CC} = 18\text{ V}$, THD = 10%	12.5	15	—	
	P_{OUT} (3)	1	$R_L = 4\ \Omega$, $V_{CC} = 12\text{ V}$, THD = 10%	11.5	13	—	
	P_{OUT} (4)	1	$R_L = 4\ \Omega$, $V_{CC} = 15\text{ V}$, THD = 10%	18	19.5	—	
Efficiency	η (1)	1	$P_{OUT} = 10\text{ W}$	80	88	—	%
	η (2)	1	$P_{OUT} = 1.0\text{ W}$	63	66	—	
Total harmonics distortion	THD	1	$P_{OUT} = 1\text{ W}$	—	0.1	0.3	%
Voltage gain	G_V	1	$V_{OUT} = 0.775\text{ V}_{rms}$	32.5	34	35.5	dB
Channel balance	CB	1	$V_{OUT} = 0.775\text{ V}_{rms}$	-1.0	0	1.0	dB
Input impedance	R_{IN}	1	—	—	30	—	k Ω
Crosstalk	C.T.	1	$R_g = 10\text{ k}\Omega$, $V_{OUT} = 0.775\text{ V}_{rms}$	-56	-65	—	dB
Output noise voltage	V_{NO}	1	$R_g = 10\text{ k}\Omega$, B.W. = DIN AUDIO	—	0.2	0.3	mV $_{rms}$
Switching frequency	f_{sw}	1	—	160	200	300	kHz
Standby supply current	I_{STB}	1	During standby	—	0.2	0.34	mA
Power transistor ON resistance	R_{DS-ON}	1	—	—	0.3	—	Ω
Mute attenuation level	ATTMUTE	1	0dB = $V_{OUT} = 0.775\text{ V}_{rms}$	-71	-78	—	dB
Control voltage for pin 17 muting switch	$V_{MUTE\ off}$	1	Not muted	1.8	—	V_{CC}	V
	$V_{MUTE\ on}$	1	Muted	GND	—	0.9	
Control voltage for pin 16 standby switch	$V_{STB\ off}$	1	Amplifier operating (not standby)	1.8	—	V_{CC}	V
	$V_{STB\ on}$	1	Amplifier stopped (standby on)	GND	—	1.1	
Control voltage for pin 26 oscillator on/off switch	$V_{OSC\ on}$	1	Oscillator operating	1.8	—	V_{CC}	V
	$V_{OSC\ off}$	1	Oscillator stopped	GND	—	0.5	

Test Circuit Diagram 1

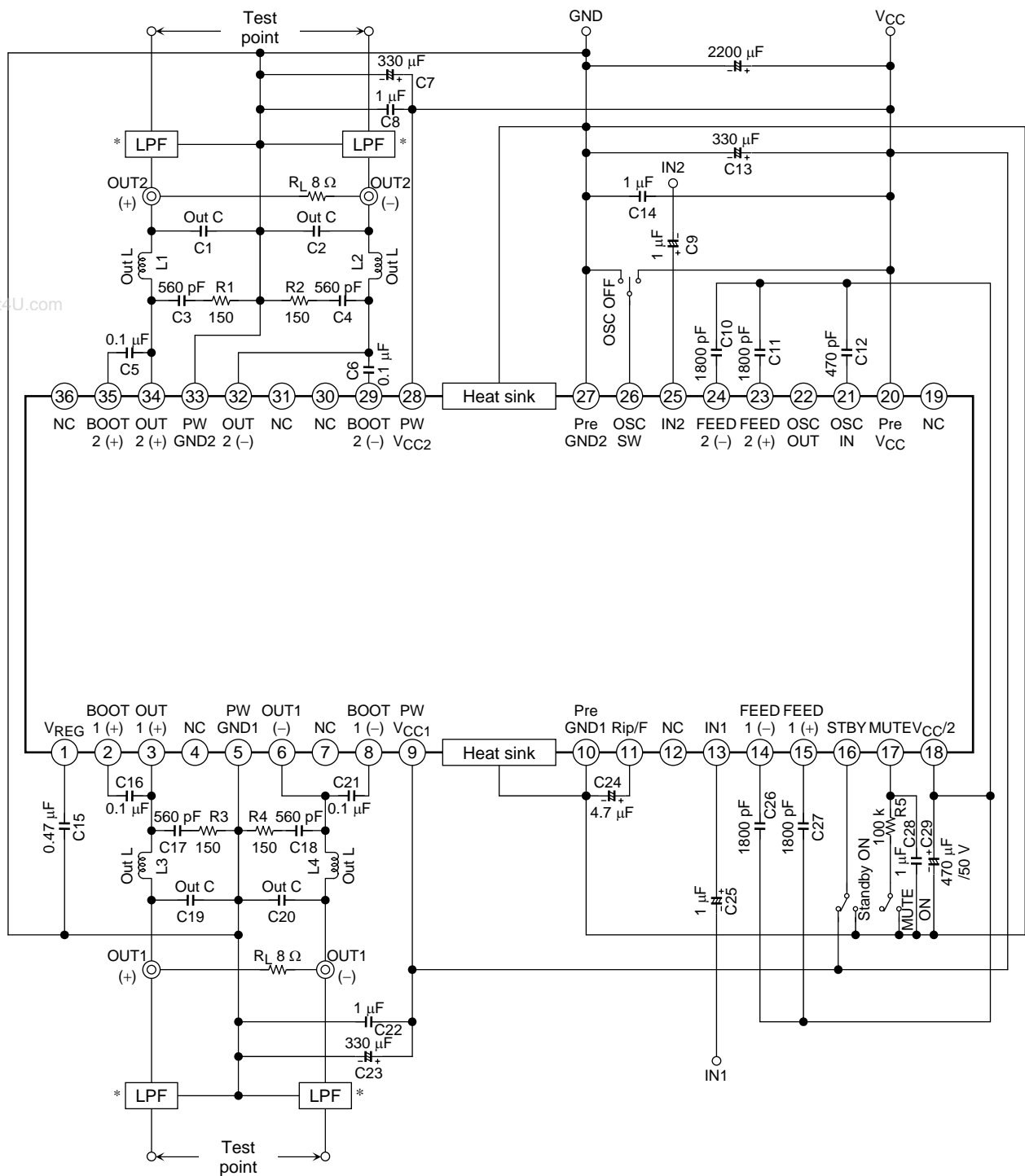

*: Output L (4 Ω): 10 μH (A7502BY-100M: TOKO, INC.)

*: Output C (4 Ω): 1.0 μF

*: Output L (8 Ω): 18 μH (A7502BY-180M: TOKO, INC.)

*: Output C (8 Ω): 0.47 μF

*: Components in the test circuits are only used to obtain and confirm the device characteristics. These components and circuits do not warrant to prevent the application equipment from malfunction or failure.

*: In addition to the low-pass filters (chebyshev LPFs) shown above, a fourth low-pass filter with a cut-off frequency of 30 kHz is used for device characterization.

Example Application Circuit

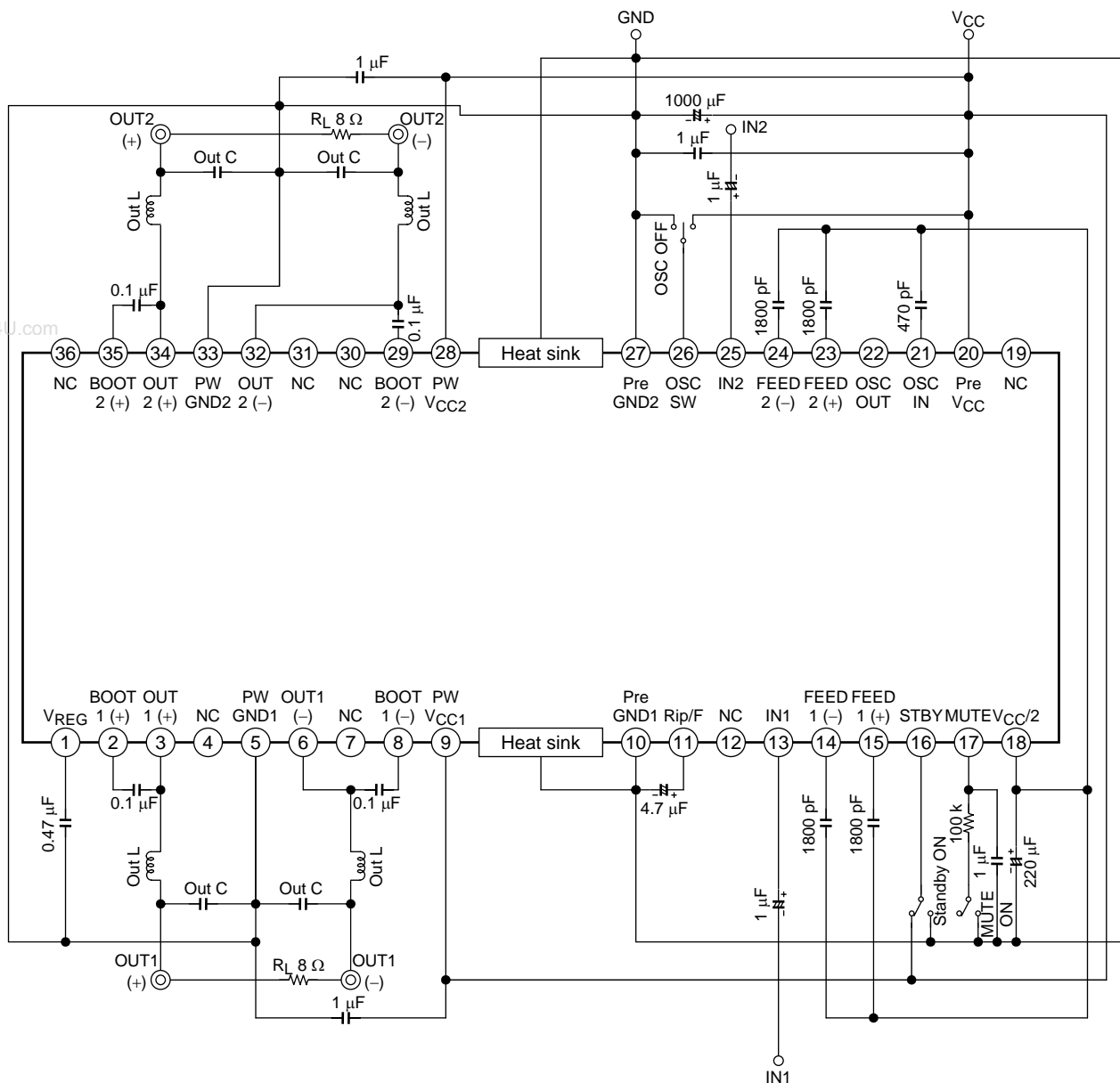

*: Output L (4 Ω): 10 μH (A7502BY-100M, A7503AY-100M, #953AS-100M: TOKO, INC.)

*: Output C (4 Ω): 1.0 μF

*: Output L (8 Ω): 18 μH (A7502BY-180M, A7503AY-180M, #953AS-180M: TOKO, INC.)

*: Output C (8 Ω): 0.47 μF

*: The application circuits shown in this document are provided for reference purposes only. Especially, thorough evaluation is required on the phase of mass production design.
Toshiba does not grant the use of any industrial property rights with these examples of application circuits.

*: When no signal is present, the power supply current varies with the characteristics of the output inductance (Out L).

*: For all capacitors that are not indicated by the electrolytic capacitor symbol, use ceramic capacitors with an appropriate withstand voltage.

Toshiba's PC Board Layout (Mounting side)

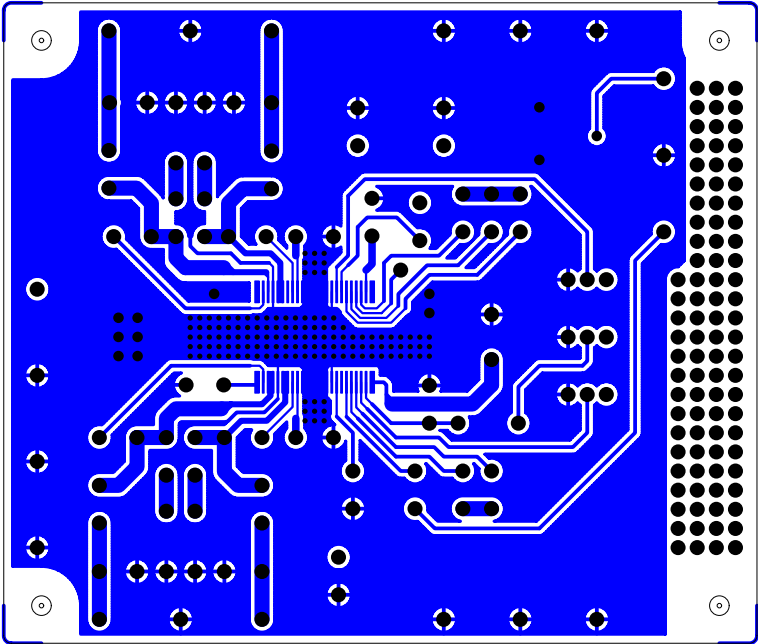

www.DataSheet4U.com

(Back side)

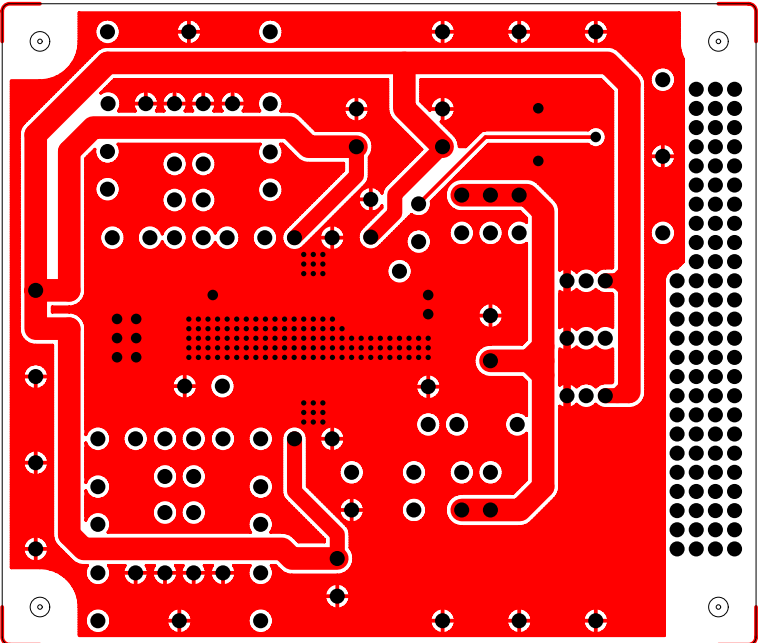

DATAs for Reference (Typ.)

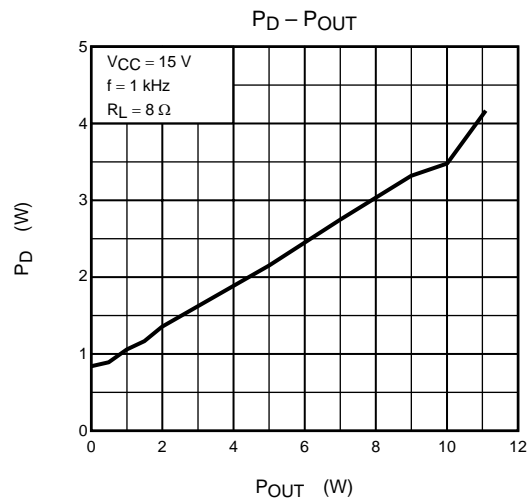
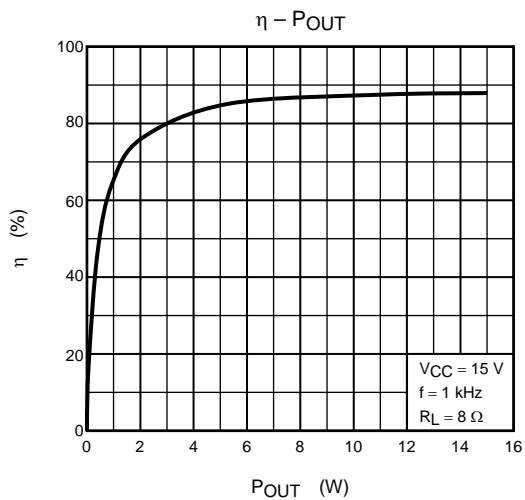
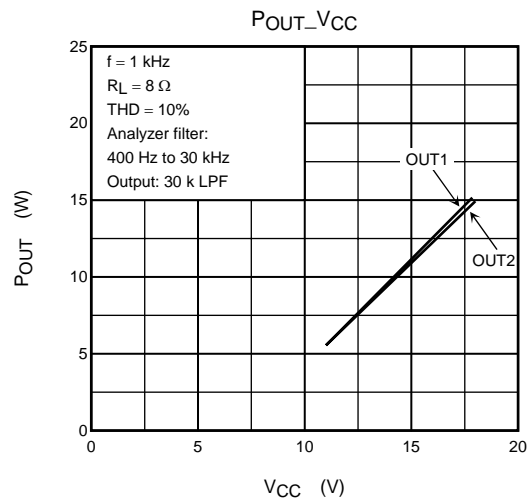
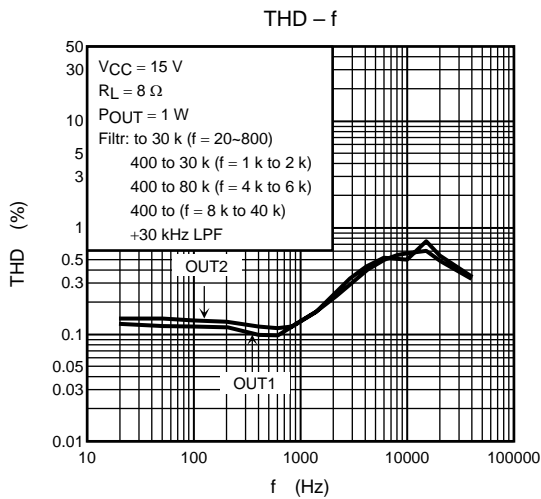
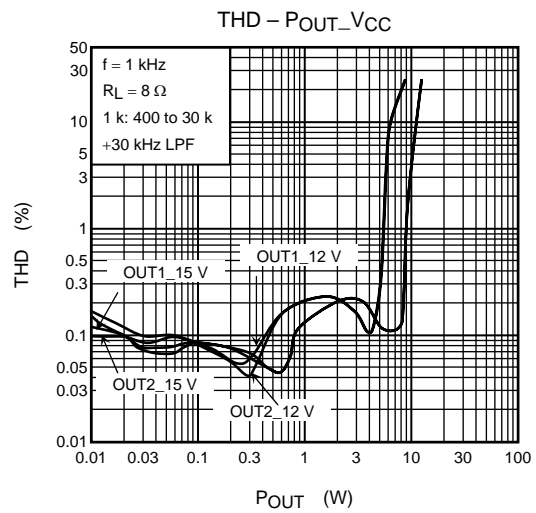
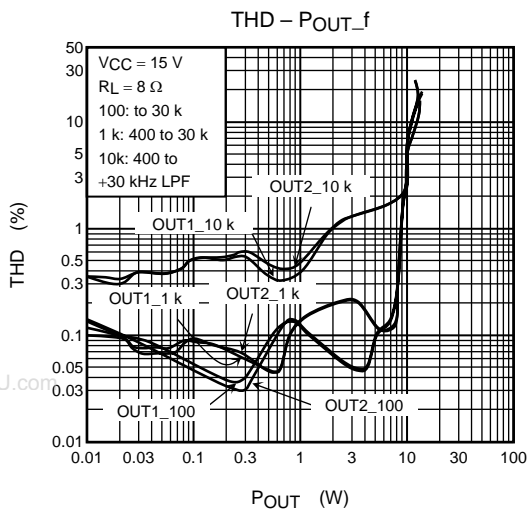

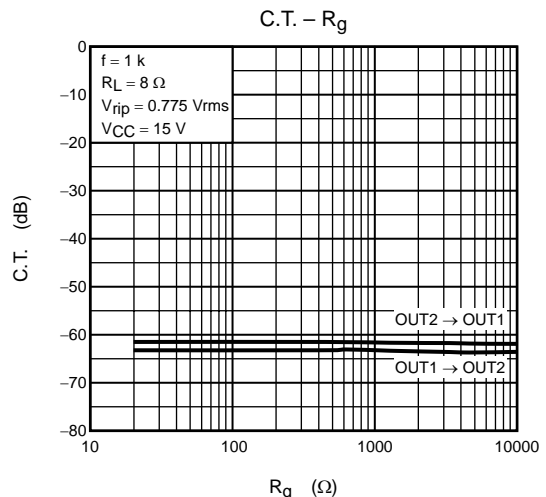
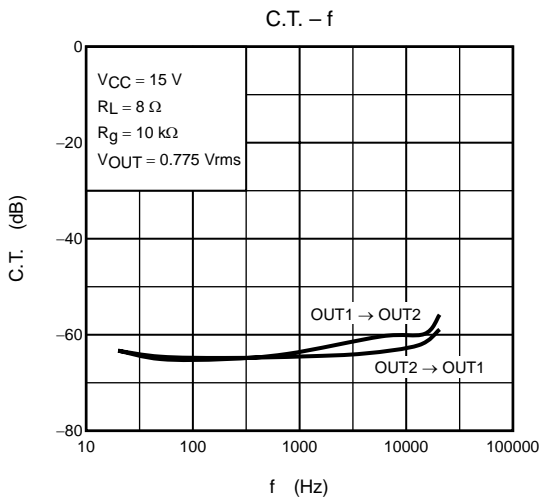
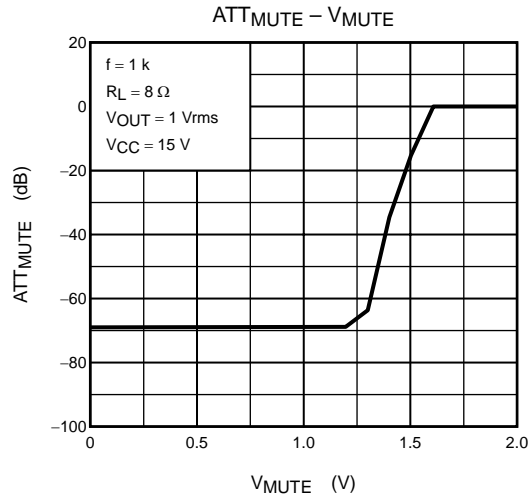
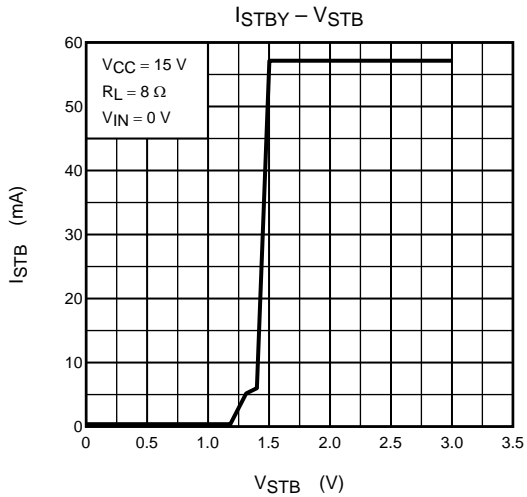
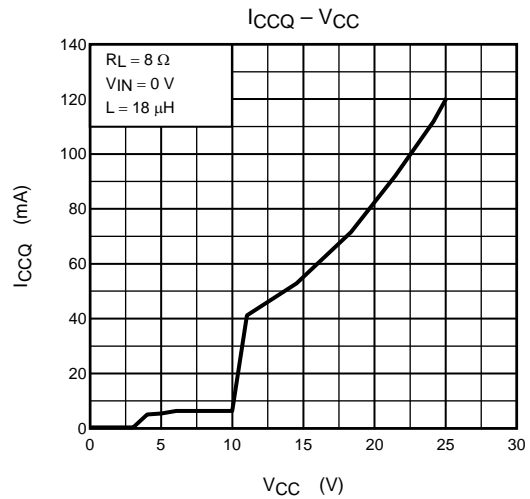
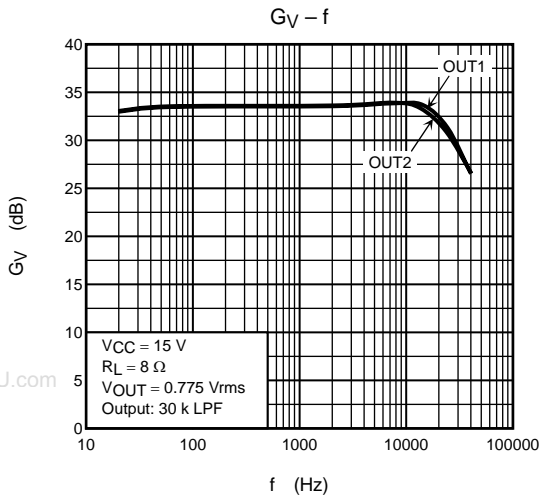

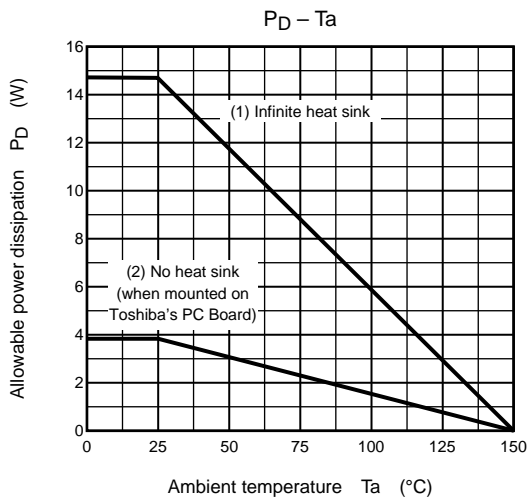
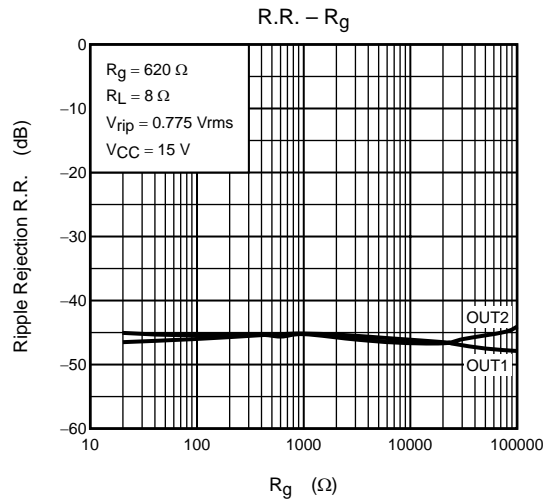
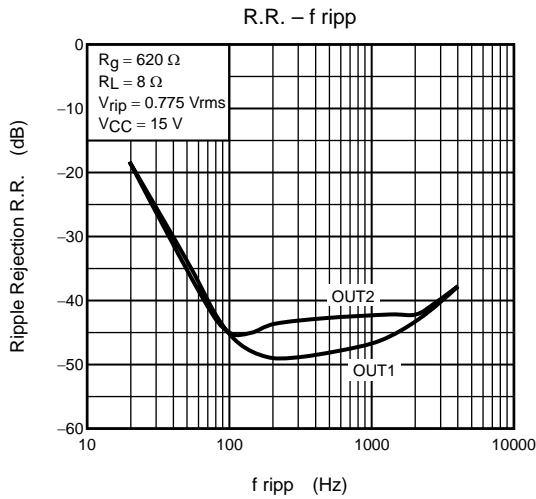
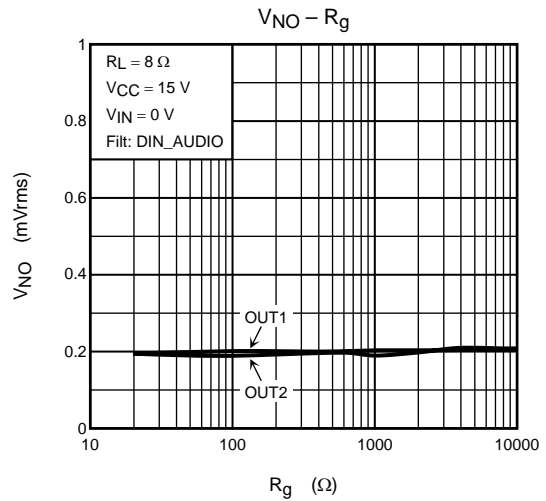
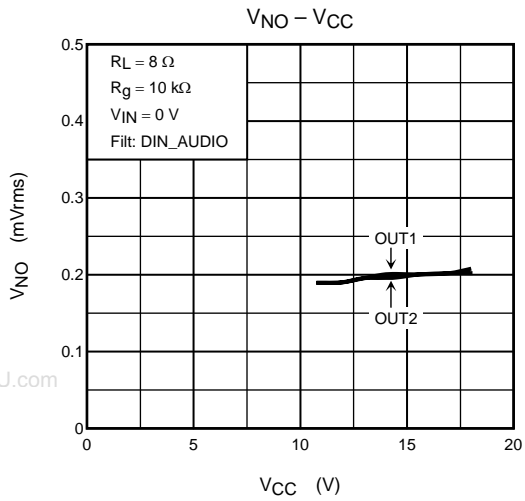

Package Dimensions

HSOP36-P-450-0.65

Unit: mm

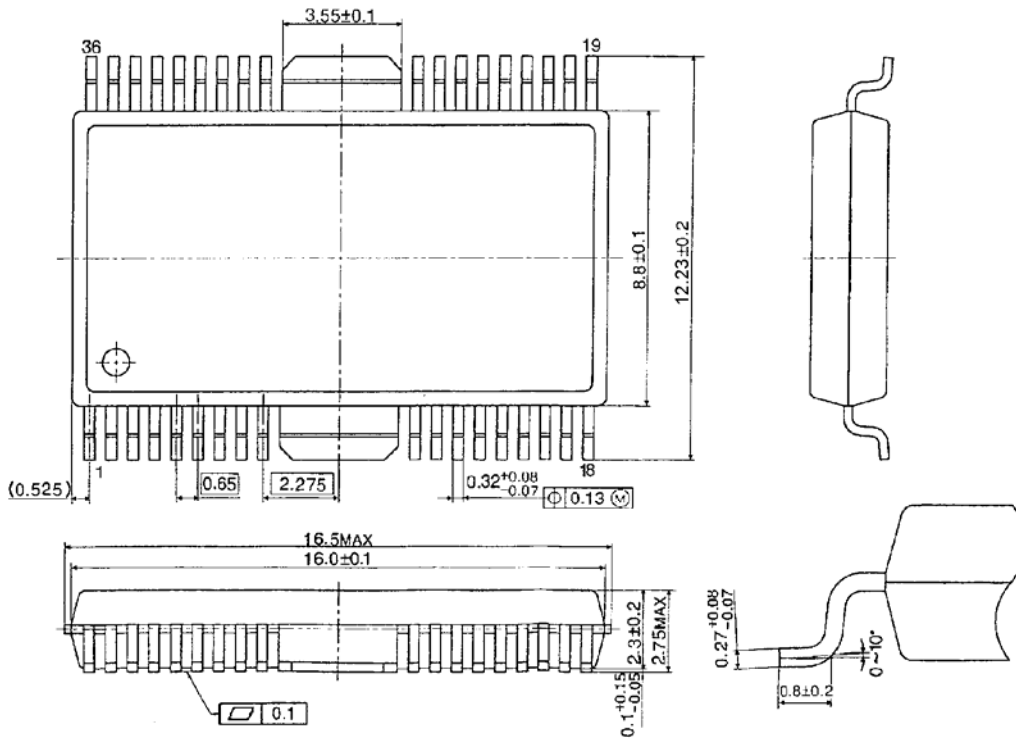

Weight: 0.85 g (typ.)

Strong Electrical and Magnetic Fields

Devices exposed to strong magnetic fields can undergo a polarization phenomenon in their plastic material, or within the chip, which gives rise to abnormal symptoms such as impedance changes or increased leakage current. Failures have been reported in LSIs mounted near malfunctioning deflection yokes in TV sets. In such cases the device's installation location must be changed or the device must be shielded against the electrical or magnetic field. Shielding against magnetism is especially necessary for devices used in an alternating magnetic field because of the electromotive forces generated in this type of environment.

- Use an appropriate power supply fuse to ensure that a large current does not continuously flow in case of over current and/or IC failure. The IC will fully break down when used under conditions that exceed its absolute maximum ratings, when the wiring is routed improperly or when an abnormal pulse noise occurs from the wiring or load, causing a large current to continuously flow and the breakdown can lead smoke or ignition. To minimize the effects of the flow of a large current in case of breakdown, appropriate settings, such as fuse capacity, fusing time and insertion circuit location, are required.
- If your design includes an inductive load such as a motor coil, incorporate a protection circuit into the design to prevent device malfunction or breakdown caused by the current resulting from the inrush current at power ON or the negative current resulting from the back electromotive force at power OFF. For details on how to connect a protection circuit such as a current limiting resistor or back electromotive force adsorption diode, refer to individual IC datasheets or the IC databook. IC breakdown may cause injury, smoke or ignition.
- Use a stable power supply with ICs with built-in protection functions. If the power supply is unstable, the protection function may not operate, causing IC breakdown. IC breakdown may cause injury, smoke or ignition.
- Carefully select external components (such as inputs and negative feedback capacitors) and load components (such as speakers), for example, power amp and regulator. If there is a large amount of leakage current such as input or negative feedback condenser, the IC output DC voltage will increase. If this output voltage is connected to a speaker with low input withstand voltage, overcurrent or IC failure can cause smoke or ignition. (The over current can cause smoke or ignition from the IC itself.) In particular, please pay attention when using a Bridge Tied Load (BTL) connection type IC that inputs output DC voltage to a speaker directly.
- Over current Protection Circuit
Over current protection circuits (referred to as current limiter circuits) do not necessarily protect ICs under all circumstances. If the Over current protection circuits operate against the over current, clear the over current status immediately. Depending on the method of use and usage conditions, such as exceeding absolute maximum ratings can cause the over current protection circuit to not operate properly or IC breakdown before operation. In addition, depending on the method of use and usage conditions, if over current continues to flow for a long time after operation, the IC may generate heat resulting in breakdown.
- Thermal Shutdown Circuit
Thermal shutdown circuits do not necessarily protect ICs under all circumstances. If the Thermal shutdown circuits operate against the over temperature, clear the heat generation status immediately. Depending on the method of use and usage conditions, such as exceeding absolute maximum ratings can cause the thermal shutdown circuit to not operate properly or IC breakdown before operation.
- Heat Radiation Design
When using an IC with large current flow such as power amp, regulator or driver, please design the device so that heat is appropriately radiated, not to exceed the specified junction temperature (T_j) at any time and condition. These ICs generate heat even during normal use. An inadequate IC heat radiation design can lead to decrease in IC life, deterioration of IC characteristics or IC breakdown. In addition, please design the device taking into consideration the effect of IC heat radiation with peripheral components.
- Installation to Heat Sink
Please install the power IC to the heat sink not to apply excessive mechanical stress to the IC. Excessive mechanical stress can lead to package cracks, resulting in a reduction in reliability or breakdown of internal IC chip. In addition, depending on the IC, the use of silicon rubber may be prohibited. Check whether the use of silicon rubber is prohibited for the IC you intend to use, or not. For details of power IC heat radiation design and heat sink installation, refer to individual technical datasheets or IC databooks.

RESTRICTIONS ON PRODUCT USE

060925EBF

- The information contained herein is subject to change without notice. 021023_D
- TOSHIBA is continually working to improve the quality and reliability of its products. Nevertheless, semiconductor devices in general can malfunction or fail due to their inherent electrical sensitivity and vulnerability to physical stress. It is the responsibility of the buyer, when utilizing TOSHIBA products, to comply with the standards of safety in making a safe design for the entire system, and to avoid situations in which a malfunction or failure of such TOSHIBA products could cause loss of human life, bodily injury or damage to property.
In developing your designs, please ensure that TOSHIBA products are used within specified operating ranges as set forth in the most recent TOSHIBA products specifications. Also, please keep in mind the precautions and conditions set forth in the "Handling Guide for Semiconductor Devices," or "TOSHIBA Semiconductor Reliability Handbook" etc. 021023_A
- The TOSHIBA products listed in this document are intended for usage in general electronics applications (computer, personal equipment, office equipment, measuring equipment, industrial robotics, domestic appliances, etc.). These TOSHIBA products are neither intended nor warranted for usage in equipment that requires extraordinarily high quality and/or reliability or a malfunction or failure of which may cause loss of human life or bodily injury ("Unintended Usage"). Unintended Usage include atomic energy control instruments, airplane or spaceship instruments, transportation instruments, traffic signal instruments, combustion control instruments, medical instruments, all types of safety devices, etc. Unintended Usage of TOSHIBA products listed in this document shall be made at the customer's own risk. 021023_B
- The products described in this document shall not be used or embedded to any downstream products of which manufacture, use and/or sale are prohibited under any applicable laws and regulations. 060106_Q
- The information contained herein is presented only as a guide for the applications of our products. No responsibility is assumed by TOSHIBA for any infringements of patents or other rights of the third parties which may result from its use. No license is granted by implication or otherwise under any patent or patent rights of TOSHIBA or others. 021023_C
- The products described in this document are subject to foreign exchange and foreign trade control laws. 060925_E
- This product generates heat during normal operation. However, substandard performance or malfunction may cause the product and its peripherals to reach abnormally high temperatures.
The product is often the final stage (the external output stage) of a circuit. Substandard performance or malfunction of the destination device to which the circuit supplies output may cause damage to the circuit or to the product. 030619_R

About solderability, following conditions were confirmed

- Solderability
 - (1) Use of Sn-37Pb solder Bath
 - solder bath temperature = 230°C
 - dipping time = 5 seconds
 - the number of times = once
 - use of R-type flux
 - (2) Use of Sn-3.0Ag-0.5Cu solder Bath
 - solder bath temperature = 245°C
 - dipping time = 5 seconds
 - the number of times = once
 - use of R-type flux