

# Legacy NMA2005-A1D 100 Hz to 10 MHz



## Specifications

RF Frequency	100 Hz to 10 MHz
Noise Output	77 dB Min ENR
Noise Spectral Density ( $N_o$ )	-97 dBm/Hz Min
Flatness	2 dB P-P Max
Peak Factor	5:1
Bias Voltage	15 V
Supply Current	12 mA Max
Impedance	50 ohms

## Package and Connectivity

Construction	DIP 14 PIN
--------------	------------

## Environmental

Operating Temperature	-55 to 95 °C
Storage Temperature	-65 to 125 °C

## Notes

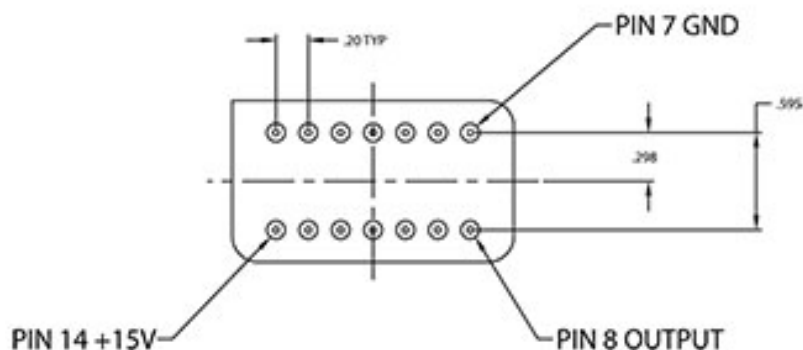
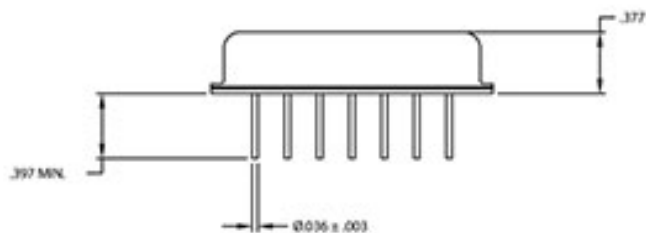
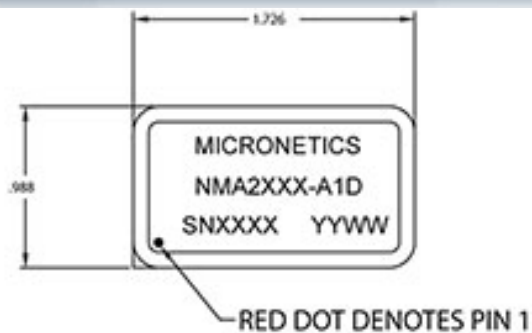

Specifications subject to change without notice

Micronetics, Inc. | Hudson, NH | Tel: 1-603-883-2900 | [www.Micronetics.com](http://www.Micronetics.com)

# MICRONETICS

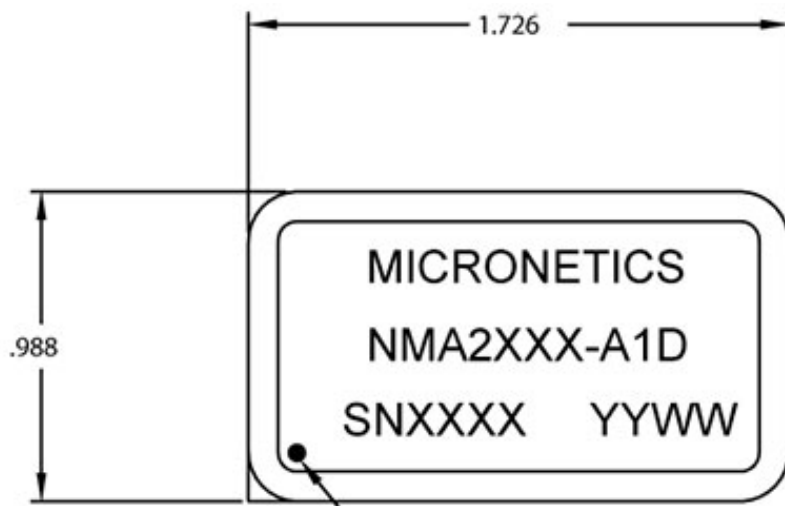

RED DOT DENOTES PIN 1

