

TRIACS

- GLASS PASSIVATED CHIP
- I_{GT} SPECIFIED IN FOUR QUADRANTS

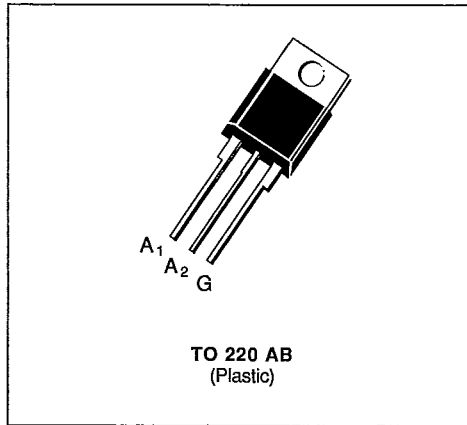

DESCRIPTION

New range suited for applications such as phase control and static switching.

ABSOLUTE RATINGS (limiting values)

Symbol	Parameter	Value	Unit
$I_{T(RMS)}$	RMS on-state Current (360° conduction angle) $T_C = 90\text{ °C}$	15	A
I_{TSM}	Non Repetitive Surge Peak on-state Current (T_J initial = 25 °C - Half sine wave)	$t = 8.3\text{ ms}$	157
		$t = 10\text{ ms}$	150
I^2t	I^2t Value for Fusing $t = 10\text{ ms}$	112.5	A ² s
di/dt	Critical Rate of Rise of on-state Current (1)	Repetitive $F = 50\text{ Hz}$	10
		Non Repetitive	50
T_{stg} T_J	Storage and Operating Junction Temperature Range	- 40 to 150	°C
		- 40 to 125	°C

Symbol	Parameter	BTB 15-					Unit
		200B	400B	600B	700B	800B	
V_{DRM}	Repetitive Peak off-state Voltage (2)	200	400	600	700	800	V

(1) $I_G = 750\text{ mA}$ $di/dt = 1\text{ A}/\mu\text{s}$
 (2) $T_J = 125\text{ °C}$.

THERMAL RESISTANCES

Symbol	Parameter	Value	Unit
$R_{th(j-a)}$	Junction to Ambient	60	°C/W
$R_{th(j-c)}\text{ DC}$	Junction to Case for DC	2.66	°C/W
$R_{th(j-c)}\text{ AC}$	Junction to Case for 360° Conduction Angle ($F = 50\text{ Hz}$)	2	°C/W

BTB 15 B

30E D

7929237 0031737 4

S G S-THOMSON

GATE CHARACTERISTICS (maximum values)

$P_{GM} = 40 \text{ W}$ ($t_p = 10 \mu\text{s}$)

$I_{GM} = 4 \text{ A}$ ($t_p = 10 \mu\text{s}$)

$P_{G(AV)} = 1 \text{ W}$

$V_{GM} = 16 \text{ V}$ ($t_p = 10 \mu\text{s}$)

T-25-15

ELECTRICAL CHARACTERISTICS

Symbol	Test Conditions	Quadrants	Min.	Typ.	Max.	Unit
I_{GT}	$T_j = 25 \text{ }^\circ\text{C}$ $V_D = 12 \text{ V}$ $R_L = 33 \text{ } \Omega$ Pulse Duration > 20 μs	I-II-III			50	mA
		IV			75	
V_{GT}	$T_j = 25 \text{ }^\circ\text{C}$ $V_D = 12 \text{ V}$ $R_L = 33 \text{ } \Omega$ Pulse Duration > 20 μs	I-II-III-IV			1.5	V
V_{GD}	$T_j = 125 \text{ }^\circ\text{C}$ $V_D = V_{DRM}$ $R_L = 3.3 \text{ k}\Omega$	I-II-III-IV	0.2			V
I_H^*	$T_j = 25 \text{ }^\circ\text{C}$ $I_T = 100 \text{ mA}$ Gate Open				50	mA
I_L	$T_j = 25 \text{ }^\circ\text{C}$ $V_D = 12 \text{ V}$ $I_G = 150 \text{ mA}$ Pulse Duration > 20 μs	I-III-IV		50		mA
		II		100		
V_{TM}^*	$T_j = 25 \text{ }^\circ\text{C}$ $I_{TM} = 21 \text{ A}$ $t_p = 10 \text{ ms}$				1.5	V
I_{DRM}^*	V_{DRM} Specified	$T_j = 25 \text{ }^\circ\text{C}$			0.01	mA
		$T_j = 125 \text{ }^\circ\text{C}$			2	
dv/dt^*	$T_j = 125 \text{ }^\circ\text{C}$ Gate Open Linear Slope up to $V_D = 67\% V_{DRM}$		250	500		V/ μs
$(dv/dt)_c^*$	$T_C = 90 \text{ }^\circ\text{C}$ $V_D = V_{DRM}$ $I_T = 21 \text{ A}$ $(di/dt)_c = 6.7 \text{ A/ms}$		10			V/ μs
t_{gt}	$T_j = 25 \text{ }^\circ\text{C}$ $V_D = V_{DRM}$ $I_T = 21 \text{ A}$ $I_G = 500 \text{ mA}$ $di_G/dt = 3.5 \text{ A}/\mu\text{s}$	I-II-III-IV		2		μs

* For either polarity of electrode A_2 voltage with reference to electrode A_1 .

PACKAGE MECHANICAL DATA

TO 220 AB Plastic

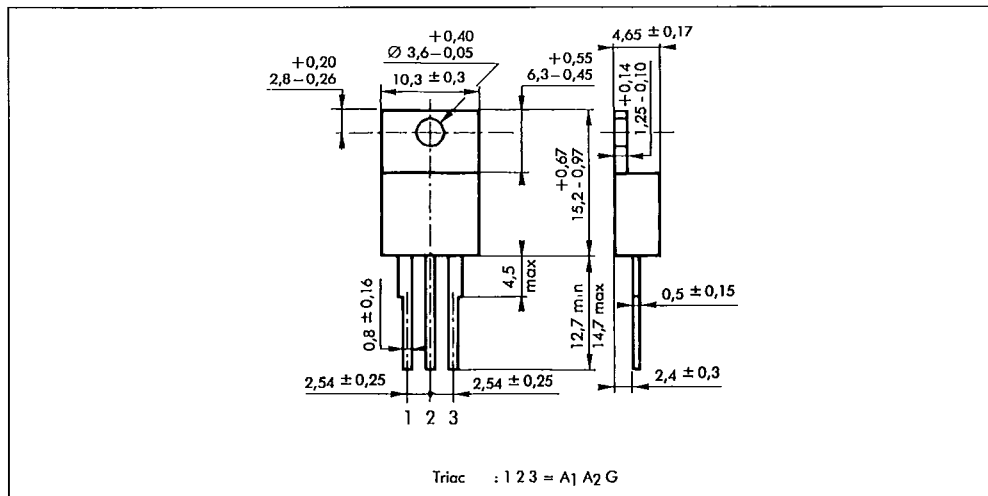

Cooling method : by conduction (method C)
 Marking : type number
 Weight : 2 g.

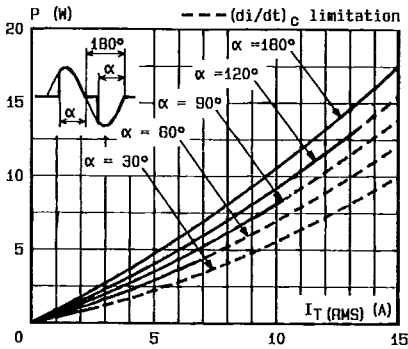

Fig.1 - Maximum mean power dissipation versus RMS on-state current ($F = 60 \text{ Hz}$).

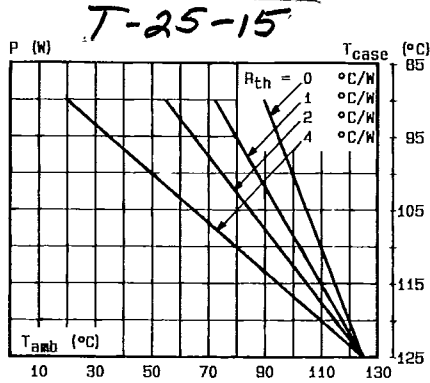

Fig.2 - Correlation between maximum mean power dissipation and maximum allowable temperatures (T_{amb} and T_{case}) for different thermal resistances heatsink + contact.

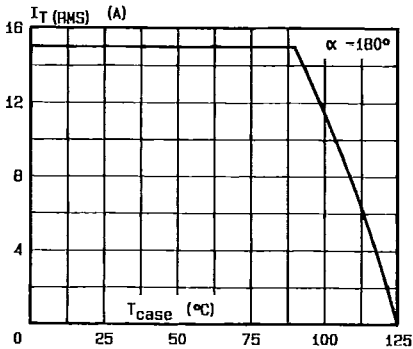

Fig.3 - RMS on-state current versus case temperature.

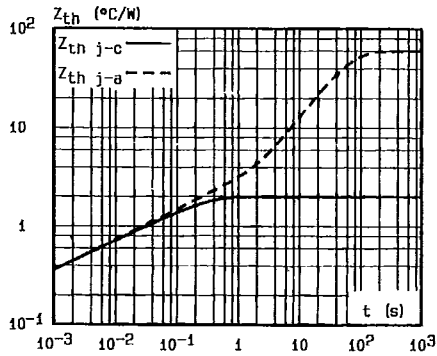

Fig.4 - Thermal transient impedance junction to case and junction to ambient versus pulse duration.

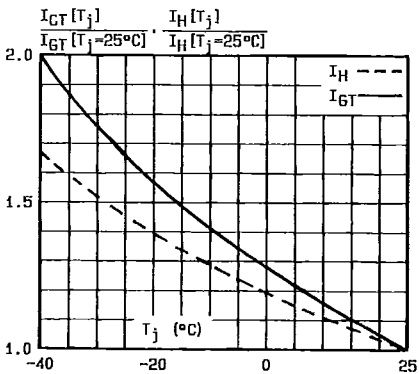

Fig.5 - Relative variation of gate trigger current and holding current versus junction temperature.

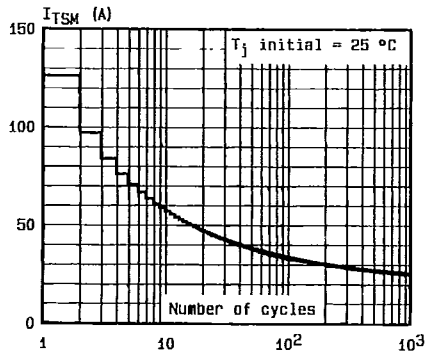

Fig.6 - Non repetitive surge peak on-state current versus number of cycles.

S G S-THOMSON

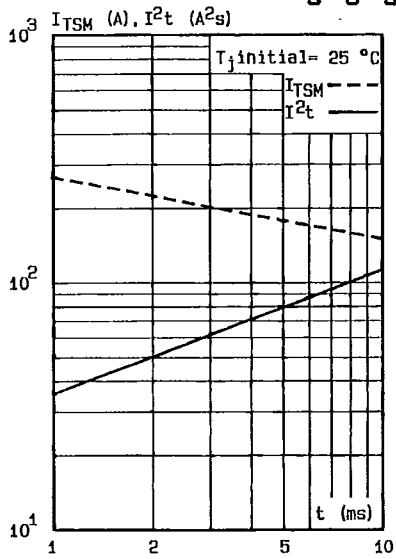

Fig.7 - Non repetitive surge peak on-state current for a sinusoidal pulse with width: $t \leq 10\text{ms}$, and corresponding value of I^2t .

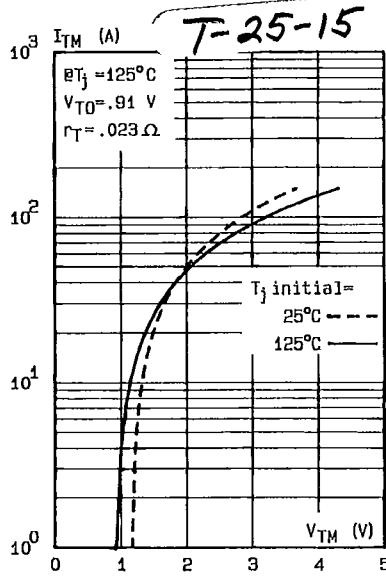

Fig.8 - On-state characteristic (maximum values).