

Chip trimmer potentiometers

MVR22

●Features

- 1) Extremely small size and light weight facilitate the assembly of light, thinner, and smaller equipment.
- 2) Close match between wiper and resistive element reduces wiper noise.
- 3) Ruthenium oxide resistor material, with superb stability and resistance to humidity and the elements, offers the same outstanding reliability of our existing product (MVR32).
- 4) Smoother and larger suction surface offers the same ease of mounting as that of the MVR32 chip.
- 5) Open design for reflow soldering.
- 6) Cross groove for easy adjustment.
- 7) Protective film prevents short circuits due to terminal contact.
- 8) The wiper is fully rotated during testing to guarantee its performance.
- 9) ROHM resistors have approved ISO-9001 certification. Design and specifications are subject to change without notice.
Carefully check the specification sheet supplied with the product before using or ordering it.

●Ratings

Item	Conditions	Specifications		
Rated power	Power must be derated according to the power derating curve in Figure 1 when ambient temperature exceeds 70°C. Fig.1	0.05W (1 / 20W) / element at 70°C		
Rated voltage	The voltage rating is calculated by the following equation. If the value obtained exceeds the maximum operating voltage, the voltage rating is equal to the maximum operating voltage. $E = \sqrt{P \times R}$ E : Rated voltage (V) P : Rated power (W) R : Nominal resistance (Ω)	<table border="1"> <tr> <td>Max. operating voltage</td> <td>30V</td> </tr> </table>	Max. operating voltage	30V
Max. operating voltage	30V			
Nominal total resistance range		100 to 1MΩ (recommended resistance value : E3 series) (applicable resistance value : E6 series)		
Total resistance tolerance		±25%		
Resistance variation		B (linear) characteristics		
Effective rotation angle		250±20°		
Operating temperature		-55°C ~ +125°C		
Reactive variable range	Rotational angle, both ends	within 10% (R>150Ω) within 20% (R≤150Ω)		

●Before using components in circuits where they will be exposed to transients such as pulse loads (short-duration, high-level loads), be certain to evaluate the component in the mounted state. In addition, the reliability and performance of this component cannot be guaranteed if it is used with a steady state voltage that is greater than its rated voltage.

●The remainder of flux may negatively affect product performance and reliability. So please make sure to wash and remove flux completely washing.

Resistors

●Characteristics

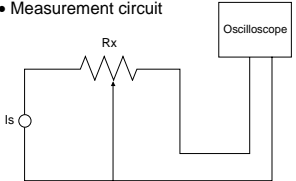
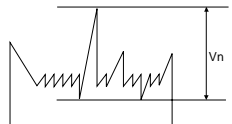
Characteristics	Specifications	Test method (JIS C 5261)
DC total resistance	Within $\pm 25\%$	JIS C 5261 5.1
Contact resistance rate	3% or less	JIS C 5261 5.9
Resistance change characteristics	B group OB	JIS C 5261 5.1 Voltage method
Residual resistance	$R < 1k\Omega$ 200 Ω or less $R \geq 1k\Omega$ Within 2% of total nominal resistance	JIS C 5261 5.1
Wiper noise	5% or less of total nominal resistance, within the effective rotational range	JIS C 5261 5.8 B method Rotational speed of approx. 10 cycles per minute (with one cycle defined as one round trip) <ul style="list-style-type: none"> • Measurement circuit  <ul style="list-style-type: none"> • Measurement waveform  <p>Provided that the constant current has been set according to the following: $I_s : I_s = \frac{10}{R_x}$ (When $R_x \leq 1k\Omega$, constant current is defined as $I_s = 10mA$) R_x : Nominal resistance of semi-fixed test resistor. V_n : Noise voltage $\text{Noise rate} = \frac{V_n}{I_s \times R_x} \times 100 (\%)$</p>
Resistance temperature characteristics	$\pm 250ppm / ^\circ C$	JIS C 5261 5.3 $+25 / -55 / +25 / +125^\circ C$
Resistance to dry heat	Total resistance change rate : $\pm (5.0\%+0.1\Omega)$ Constriction contact resistance rate: 8% or less	JIS C 5261 7.2 $125^\circ C$ Test time : 1,000 to 1,048 hrs.
Temperature cycling	Total resistance change rate : $\pm (5.0\%+0.1\Omega)$ Constriction contact resistance rate: 8% or less	JIS C 5261 7.3 Test temperature: $-55^\circ C$ to $+125^\circ C$ 100cyc.
Resistance to humidity (steady state)	Total resistance change rate : $\pm (5.0\%+0.1\Omega)$ Constriction contact resistance rate: 8% or less	JIS C 5261 7.4 $60^\circ C$, 95%RH Test time: 1,000 to 1,048 hrs.
Endurance (under load in damp environment)	Total resistance change rate : $\pm (5.0\%+0.1\Omega)$ Constriction contact resistance rate: 8% or less	JIS C 5261 7.6 Rated voltage (current) , $60^\circ C$, 95%RH 1.5h : ON -0.5h : OFF Test time: 1,000 to 1,048 hrs.
Endurance (steady state)	Total resistance change rate : $\pm (5.0\%+0.1\Omega)$ Constriction contact resistance rate : 8% or less	JIS C 5261 7.7 Rated voltage (current) , $70^\circ C$ 1.5h : ON -0.5h : OFF Test time: 1,000 to 1,048 hrs.
Rotational torque	0.5 to 15.0mN \cdot m (5 to 150gf \cdot cm)	JIS C 5261 6.2
Endurance (wiper)	Total resistance change rate : Within $\pm 15\%$ Constriction contact resistance rate : 8% or less	JIS C 5261 7.8 After 20 rotations

Resistors

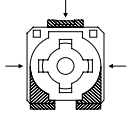
Characteristics	Specifications	Test method (JIS C 5261)
Terminal strength (compression)	Total resistance change rate : $\pm (3.0\%+0.1\Omega)$ There must be no mechanical damage. 	JIS C 5261 6.5 Force (4.9N) is applied from three directions upon the middle of the sides of the sample on the surface being tested, as shown in the illustration on the left.
Terminal strength (flexural)	Total resistance change rate : $\pm (3.0\%+0.1\Omega)$ There must be no mechanical damage.	JIS C 5261 6.5 Duration of pressure : $5\pm 1s$ Amount of bending : 3 mm
Resistance to soldering heat	Total resistance change rate : $\pm (3.0\%+0.1\Omega)$ Constriction contact resistance rate : 5% or less	JIS C 5261 6.7 Soldering conditions : $260\pm 5^{\circ}C$ Soldering time : $10\pm 1s$.
Solderability	95% of terminal surface must be covered by new soldering, and there must be no soldering corrosion.	JIS C 5261 6.8 Flux : Rosin methanol or rosin isopropyl alcohol Solder : H63A Soldering conditions : $235\pm 5^{\circ}C$ Soldering time : $2.0\pm 0.5s$.

●External dimensions (Units: mm)

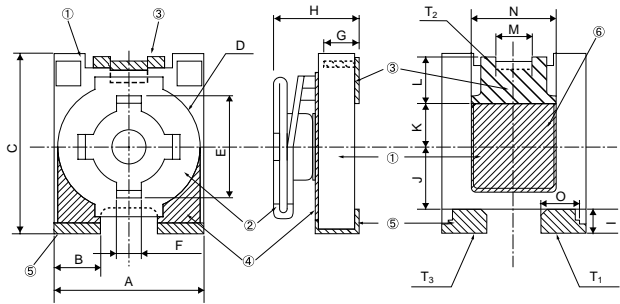

Part	Material
① Substrate	Alumina
② Wiper	Stainless steel
③ Eyelet	Stainless steel + metal plating
④ Dielectric glaze	Ruthenium oxide dielectric glaze
⑤ Electrode	Thick film of palladium-silver + soldering tip
⑥ Protective film	Organic film

(Units : mm)

A	B	C	D	E	F	G	H
$2.0^{+0.15}_{-0.05}$	0.65 ± 0.1	2.7 ± 0.15	$\phi 2.0^{0}_{-0.05}$	$1.35^{+0.05}_{0}$	$0.4^{+0.05}_{0}$	$0.64^{0}_{-0.1}$	1.45 ± 0.06
I	J	K	L	M	N	O	
0.5 ± 0.1	0.85 ± 0.1	0.65 ± 0.1	0.65 ± 0.1	0.9 ± 0.1	$1.17^{0}_{-0.05}$	0.5 ± 0.1	

●Equivalent circuit

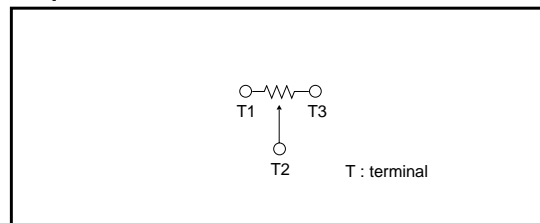

Resistors

●Packaging

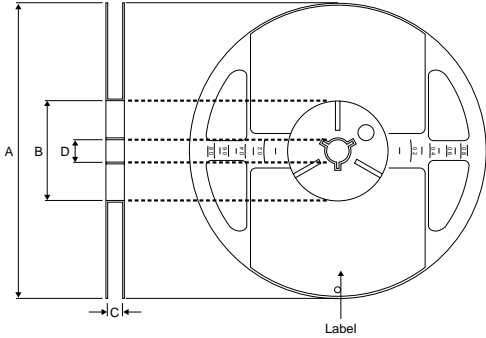
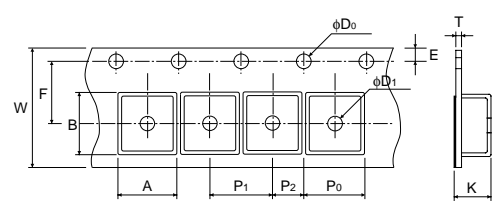
Reel	Taping																																								
 <p style="text-align: center;">EIAJ ET-7001 compliant</p> <p style="text-align: center;">(Units : mm)</p> <table border="1" style="margin-left: auto; margin-right: auto; border-collapse: collapse;"> <thead> <tr> <th>A</th> <th>B</th> <th>C</th> <th>D</th> </tr> </thead> <tbody> <tr> <td style="text-align: center;">$\phi 180$</td> <td style="text-align: center;">$\phi 60$</td> <td style="text-align: center;">9 ± 0.3</td> <td style="text-align: center;">$\phi 13 \pm 0.3$</td> </tr> <tr> <td style="text-align: center;">0 -3</td> <td style="text-align: center;">+1 0</td> <td></td> <td></td> </tr> </tbody> </table>	A	B	C	D	$\phi 180$	$\phi 60$	9 ± 0.3	$\phi 13 \pm 0.3$	0 -3	+1 0			 <p style="text-align: center;">(Units : mm)</p> <table border="1" style="margin-left: auto; margin-right: auto; border-collapse: collapse;"> <thead> <tr> <th>A</th> <th>B</th> <th>W</th> <th>F</th> <th>E</th> <th>P₁</th> <th>P₂</th> </tr> </thead> <tbody> <tr> <td style="text-align: center;">2.25 ± 0.1</td> <td style="text-align: center;">3.0 ± 0.1</td> <td style="text-align: center;">8.0 ± 0.2</td> <td style="text-align: center;">3.5 ± 0.05</td> <td style="text-align: center;">1.75 ± 0.1</td> <td style="text-align: center;">4.0 ± 0.1</td> <td style="text-align: center;">2.0 ± 0.05</td> </tr> <tr> <th>P₀</th> <th>D₀</th> <th>T</th> <th>K</th> <th>D₁</th> <td></td> <td></td> </tr> <tr> <td style="text-align: center;">4.0 ± 0.1</td> <td style="text-align: center;">$\phi 1.5^{+0.1}_0$</td> <td style="text-align: center;">0.2 ± 0.1</td> <td style="text-align: center;">$1.8^{+0}_{-0.1}$</td> <td style="text-align: center;">$\phi 1.0^{+0.1}_0$</td> <td></td> <td></td> </tr> </tbody> </table>	A	B	W	F	E	P ₁	P ₂	2.25 ± 0.1	3.0 ± 0.1	8.0 ± 0.2	3.5 ± 0.05	1.75 ± 0.1	4.0 ± 0.1	2.0 ± 0.05	P ₀	D ₀	T	K	D ₁			4.0 ± 0.1	$\phi 1.5^{+0.1}_0$	0.2 ± 0.1	$1.8^{+0}_{-0.1}$	$\phi 1.0^{+0.1}_0$		
A	B	C	D																																						
$\phi 180$	$\phi 60$	9 ± 0.3	$\phi 13 \pm 0.3$																																						
0 -3	+1 0																																								
A	B	W	F	E	P ₁	P ₂																																			
2.25 ± 0.1	3.0 ± 0.1	8.0 ± 0.2	3.5 ± 0.05	1.75 ± 0.1	4.0 ± 0.1	2.0 ± 0.05																																			
P ₀	D ₀	T	K	D ₁																																					
4.0 ± 0.1	$\phi 1.5^{+0.1}_0$	0.2 ± 0.1	$1.8^{+0}_{-0.1}$	$\phi 1.0^{+0.1}_0$																																					

●Product designation

Part No.

M
V
R
2
2
H
X
B
R
N

⏟

Packaging / Processing specifications

⏟

Resistance tolerance

⏟

Nominal resistance

Code	Part No.	Processing specifications	Packaging specifications	Packaging style	Standard ordering unit(pcs)	Resistance tolerance	Nominal resistance
HXBR	MVR22	Reflow soldering	Taping	Embossed tape with reel	2000	N ± 25%	3-digit IEC coding system

Resistors

●Recommended screwdriver for adjusting MVR resistors

Model	Open, type 2 MVR22
Dimensions, configuration	Manual adjustment, automatic adjustment 
Commercially sold product (Maker)	No.9000(+) 0×30 [Vessel] No.205 (+) No.0 [Vessel]

●Dimensions (Units : mm)

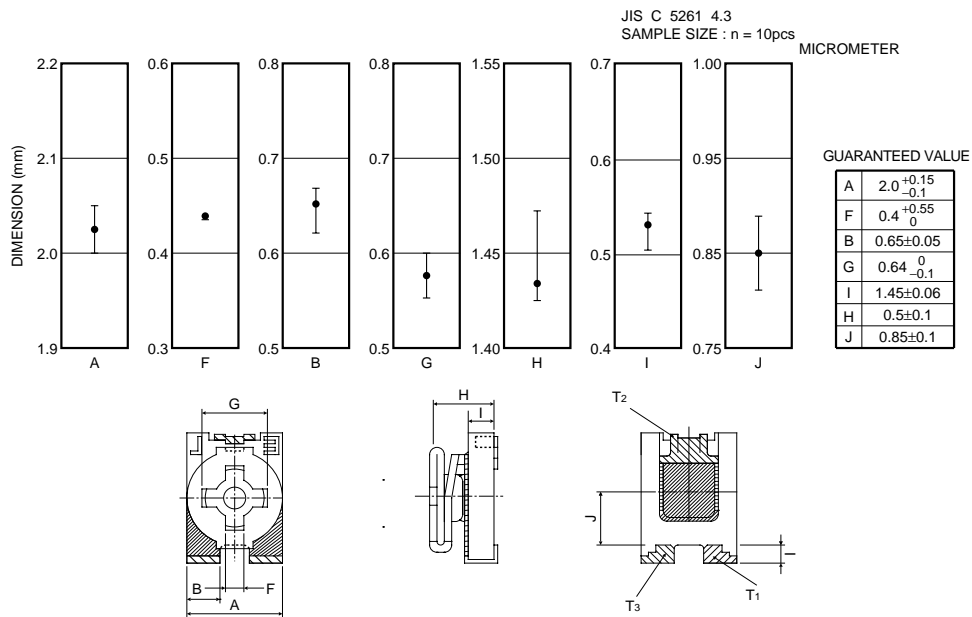

Fig.2 Dimensions

Resistors

●Electrical characteristics

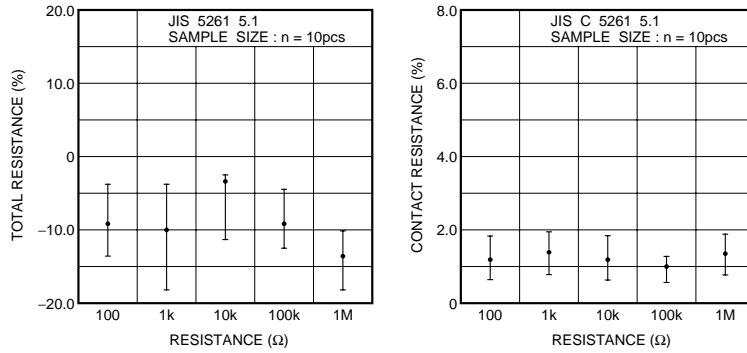

Fig.3 DC resistance : Total and contact

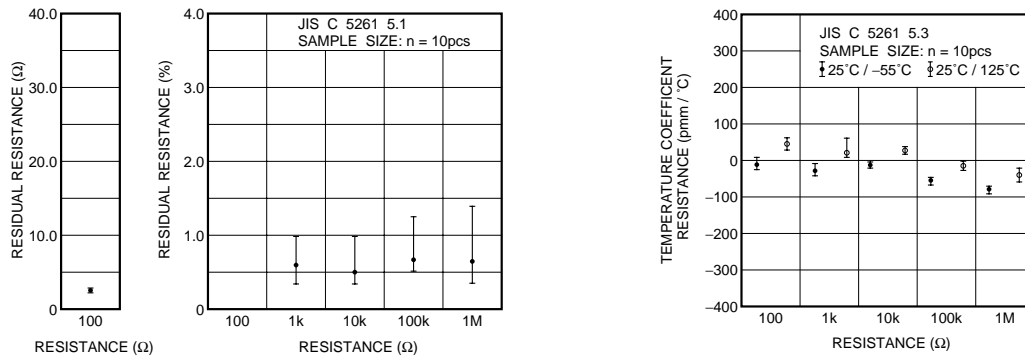

Fig.4 Residual resistance

Fig.5 Resistance temperature characteristics

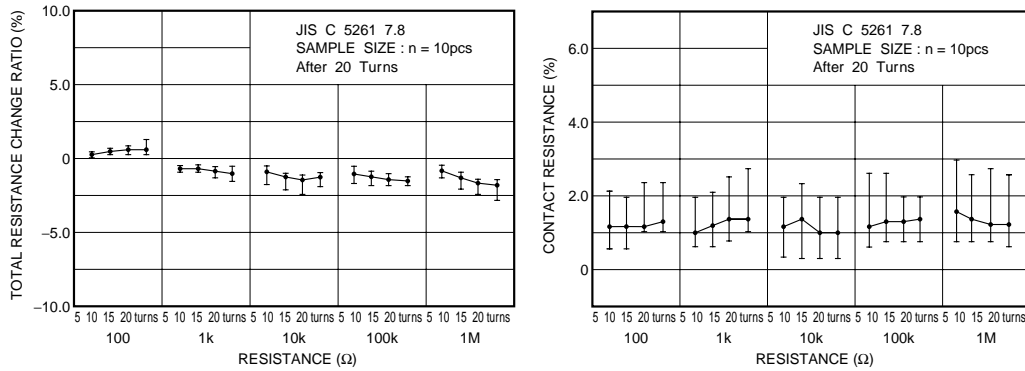

Fig.6-1 Endurance (wiper)

Fig.6-2 Endurance (wiper)

Resistors

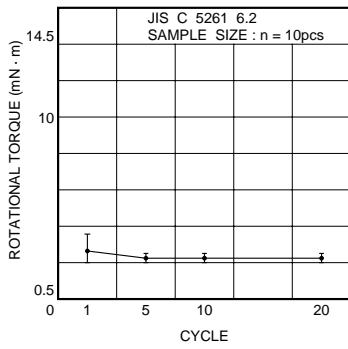

Fig.7 Rotational torque

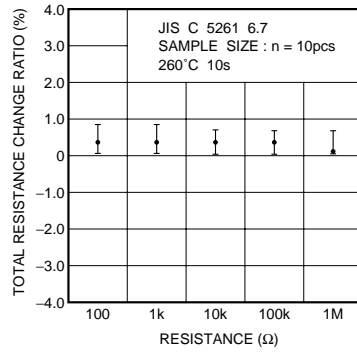

Fig.8 Resistance to soldering heat

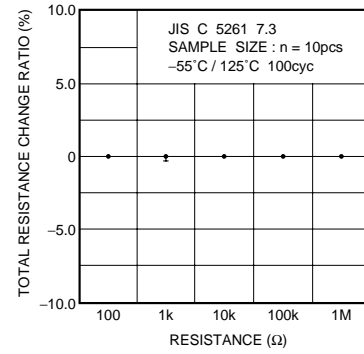
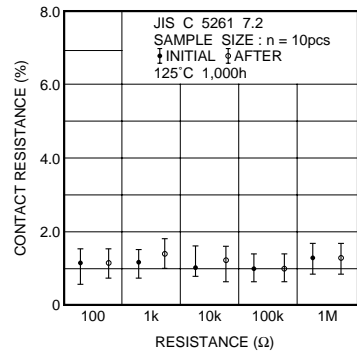
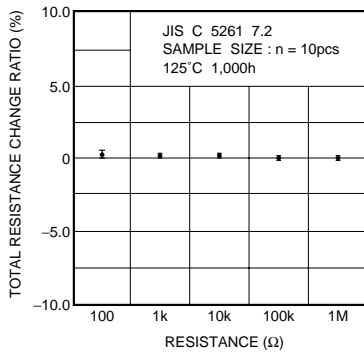
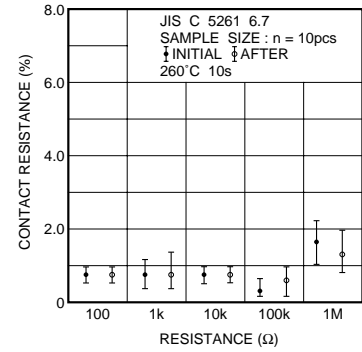

Fig.9 Resisance to dry heat

Fig.10-1 Temperature cycling

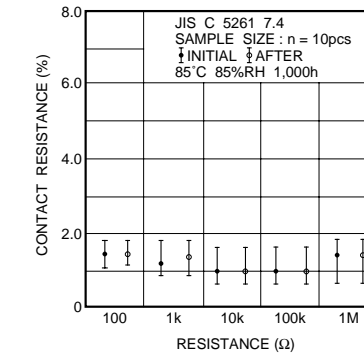
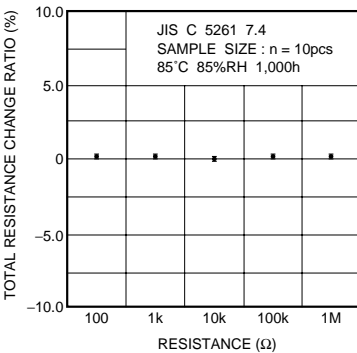
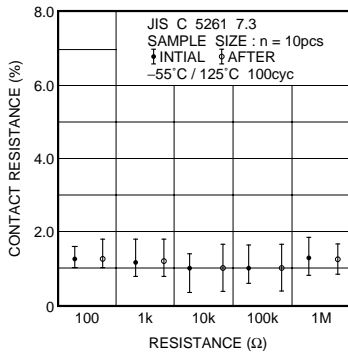

Fig.10-2 Temperature cycling

Fig.11 Resistance to humidity (steady state)

Resistors

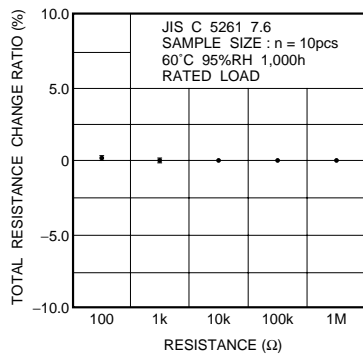

Fig.12 Endurance (under load in damp environment)

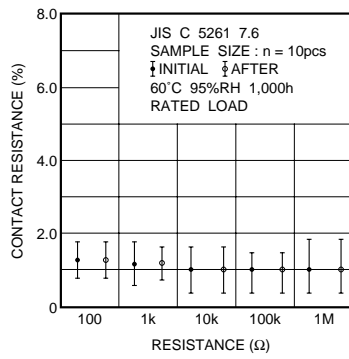

Fig.13-1 Endurance (rated load)

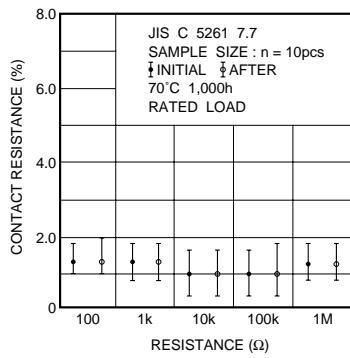
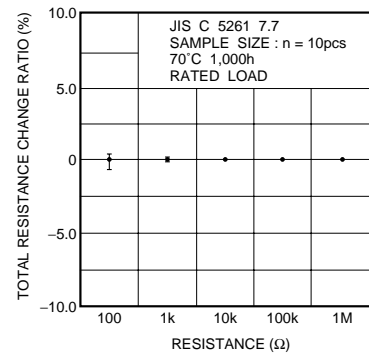

Fig.13-2 Endurance (rated load)

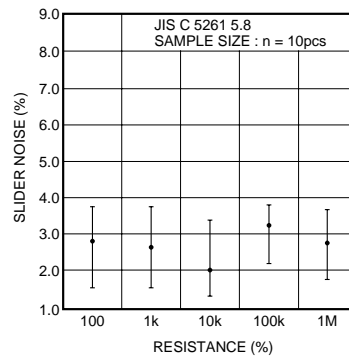

Fig.14 Wiper noise