

# TMC-4F30-xxx

## VCSEL TO-46 metal can for general purpose

### FEATURES:

- Industry standard TO-46 package with flat window glass.
- Low dependence of power output over temperature.
- Symmetrical beam.
- Packaged with a photodiode.
- Cost-effective laser light source.

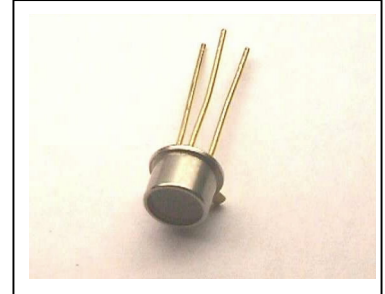

### ELECTRO-OPTICAL CHARACTERISTICS:

PARAMETERS	SYMBOL	MIN	TYP	MAX	UNIT	TEST CONDITIONS <sup>(1)</sup>
Threshold Current	$I_{th}$		5	10	mA	
Output Power	$P_o$	1	2	4	mW	$I_F=15\text{ mA}$ <sup>(2)</sup>
Operating Current	$I_{OP}$		12		mA	Adjustable to establish 1.5 mW output power
Slope Efficiency	$\eta$		0.20		mW/mA	$I_F=15\text{ mA}$ <sup>(3)</sup>
Wavelength	$\lambda_p$	820	850	870	nm	$I_F=15\text{ mA}$
Forward Voltage	$V_F$	2.0	2.2	2.5	V	$I_F=15\text{ mA}$
Breakdown voltage	$V_{BD}$	10	15		V	$I_R=10\text{ }\mu\text{A}$
Series Resistance	$R_S$		40		$\Omega$	$I_F=15\text{ mA}$
Monitor Current	$I_M$	1	2		$\mu\text{A}$	$V_R=5\text{ V}$ , $P_o=1.5\text{ mW}$
Beam Divergence	$\theta$		8		degree	$I_F=15\text{ mA}$ <sup>(4)</sup>

Notes:

1. All parameters except mentioned are measured at  $I_F=15\text{ mA}$ ,  $25^\circ\text{C}$ , CW.
2. Higher power can be provided under request.
3. Slope efficiency is defined as  $\Delta P/(15-I_{th})$  at  $25^\circ\text{C}$ .
4. Beam divergence is defined as the angle of light intensity at Full Width at Half Maximum (FWHM).

### THERMAL CHARACTERISTICS:

PARAMETERS	SYMBOL	MIN	TYP	MAX	UNIT	TEST CONDITIONS
Thermal Resistance	$R_{th}$		900		$^\circ\text{C}/\text{W}$	$T_A=25^\circ\text{C}$
$I_{th}$ Temperature Variation	$\Delta I_{th}$	-1.5		1.5	mA	$T_A=0\sim 70^\circ\text{C}$
$V_F$ Temperature Coefficient	$\Delta V_F/\Delta T$		-3.0		mV/ $^\circ\text{C}$	$T_A=0\sim 70^\circ\text{C}$ , $I_F=15\text{ mA}$
Temperature Coefficient	$\Delta\eta/\Delta T$		-0.20		%/ $^\circ\text{C}$	$T_A=0\sim 70^\circ\text{C}$ , $I_F=15\text{ mA}$
$\lambda_p$ Temperature Coefficient	$\Delta\lambda_p/\Delta T$		0.06		nm/ $^\circ\text{C}$	$T_A=0\sim 70^\circ\text{C}$ , $I_F=15\text{ mA}$

### ABSOLUTE MAXIMUM RATINGS:

PARAMETERS	MIN	MAX	UNIT	CONDITIONS
Storage Temperature	-40	125		
Operating Temperature	-20	85		
Lead Solder Temperature		260		5 seconds
Continuous Forward Current		40	mA	
Continuous Reverse Voltage		10	V	

Fig. 1 Typical Optical Characteristics

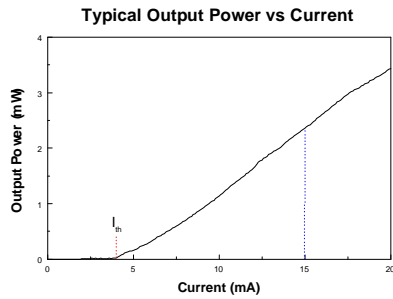

Fig. 2 Typical Electrical Characteristics

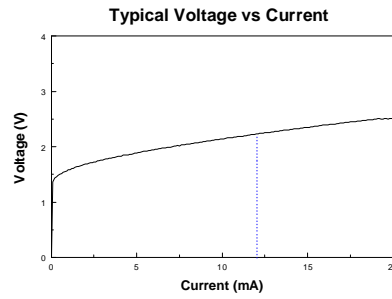
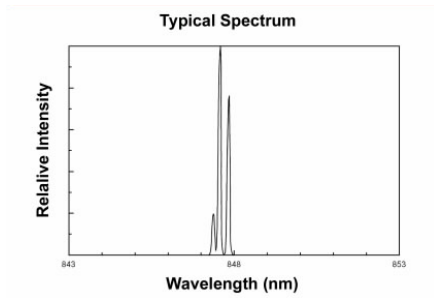
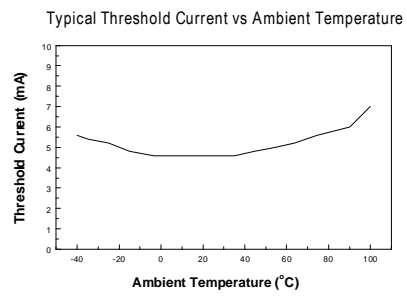

Fig. 3 Spectrum When Driving Current 15 mA



3 transverse modes typically.

Fig. 4 Temperature Dependence of Threshold Current



**WARNING:**

The VCSEL is a class IIIb laser in the safety standard ANSI Z136.1 and should be treated as a potential eye hazard.

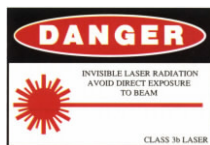

**OUTLINE DIMENSIONS:**

• Unit: mm

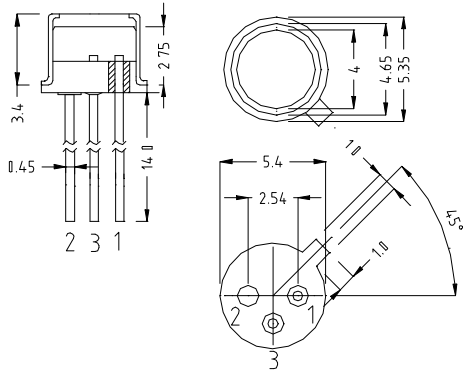

• PINOUT:

**TMC-4F30-801**

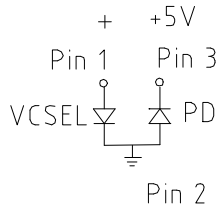

Pin 1: VCSEL Anode

Pin 2: VCSEL Cathode  
PD Anode  
Case

Pin 3: PD Cathode

**TMC-4F30-802**

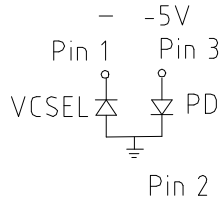

Pin 1: VCSEL Cathode

Pin 2: VCSEL Anode  
PD Cathode  
Case

Pin 3: PD Anode

**TMC-4F30-803**

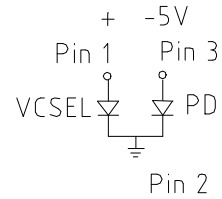

Pin 1: VCSEL Anode

Pin 2: VCSEL Cathode  
PD Cathode  
Case

Pin 3: PD Anode