

## Descriptions

- General purpose amplifier
- High voltage application

## Features

- High collector breakdown voltage :  
 $V_{CBO} = 180V$ ,  $V_{CEO} = 160V$
- Low collector saturation voltage :  
 $V_{CE(sat)} = 0.5V(MAX.)$
- Complementary pair with 2N5401

## PIN Connection

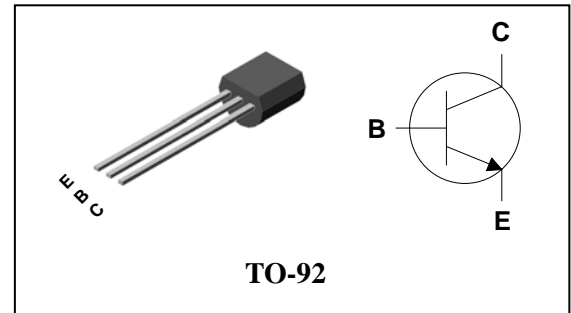

## Ordering Information

Type NO.	Marking	Package Code
2N5551	2N5551	TO-92

## Absolute maximum ratings

(Ta=25°C)

Characteristic	Symbol	Ratings	Unit
Collector-Base voltage	$V_{CBO}$	180	V
Collector-Emitter voltage	$V_{CEO}$	160	V
Emitter-Base voltage	$V_{EBO}$	6	V
Collector current	$I_C$	600	mA
Collector dissipation	$P_C$	625	mW
Junction temperature	$T_j$	150	°C
Storage temperature	$T_{stg}$	-55 ~ 150	°C

## Electrical Characteristics

(Ta=25°C)

Characteristic	Symbol	Test Condition	Min.	Typ.	Max.	Unit
Collector-Base breakdown voltage	$BV_{CBO}$	$I_C=100\mu A, I_E=0$	180	-	-	V
Collector-Emitter breakdown voltage	$BV_{CEO}$	$I_C=1mA, I_B=0$	160	-	-	V
Emitter-Base breakdown voltage	$BV_{EBO}$	$I_E=10\mu A, I_C=0$	6	-	-	V
Collector cut-off current	$I_{CBO}$	$V_{CB}=120V, I_E=0$	-	-	100	nA
Emitter cut-off current	$I_{EBO}$	$V_{EB}=4V, I_C=0$	-	-	100	nA
DC current gain	$h_{FE(1)}$	$V_{CE}=5V, I_C=1mA$	80	-	-	-
DC current gain	$h_{FE(2)}$	$V_{CE}=5V, I_C=10mA$	80	-	250	-
DC current gain	$h_{FE(3)}$	$V_{CE}=5V, I_C=50mA$	30	-	-	-
Collector-Emitter saturation voltage	$V_{CE(sat)(1)}^*$	$I_C=10mA, I_B=1mA$	-	-	0.2	V
Collector-Emitter saturation voltage	$V_{CE(sat)(2)}^*$	$I_C=50mA, I_B=5mA$	-	-	0.5	V
Base-Emitter saturation voltage	$V_{BE(sat)(1)}^*$	$I_C=10mA, I_B=1mA$	-	-	1	V
Base-Emitter saturation voltage	$V_{BE(sat)(2)}^*$	$I_C=50mA, I_B=5mA$	-	-	1	V
Transition frequency	$f_T$	$V_{CE}=10V, I_C=10mA$	100	-	400	MHz
Collector output capacitance	$C_{ob}$	$V_{CB}=10V, I_E=0, f=1MHz$	-	-	6	pF

\* : Pulse Tester : Pulse Width  $\leq 300\mu s$ , Duty Cycle  $\leq 2.0\%$

Electrical Characteristic Curves

Fig. 1  $P_C - T_a$

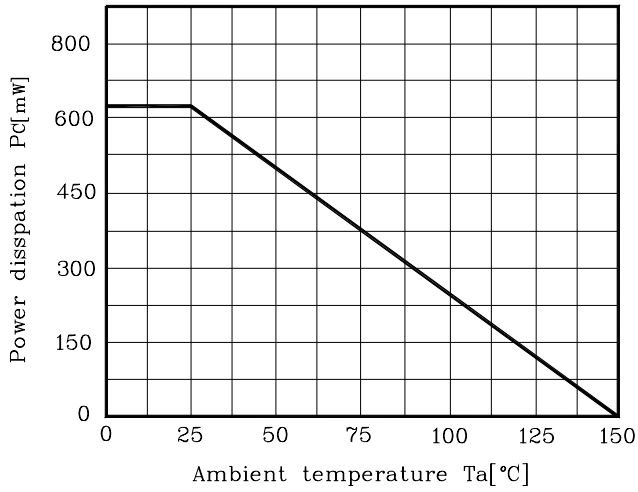

Fig. 2  $I_C - V_{BE}$

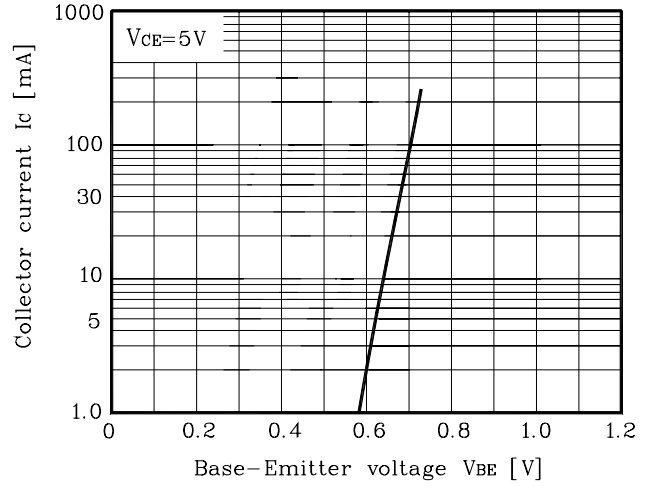

Fig. 3  $f_T - I_C$

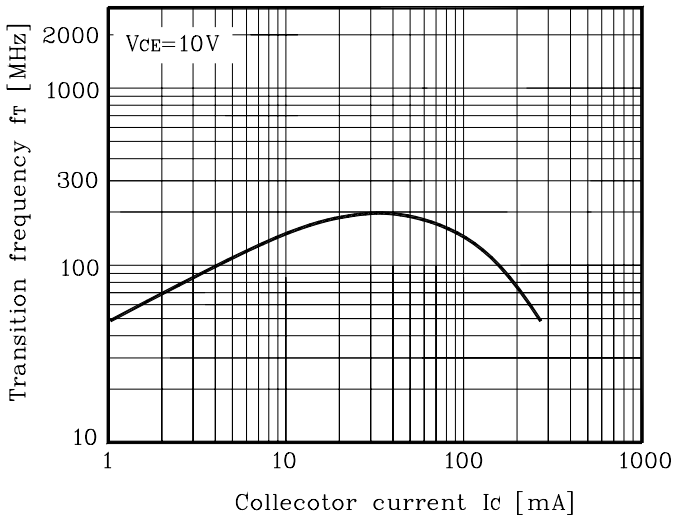

Fig. 4  $V_{CE(sat)}, V_{BE(sat)} - I_C$

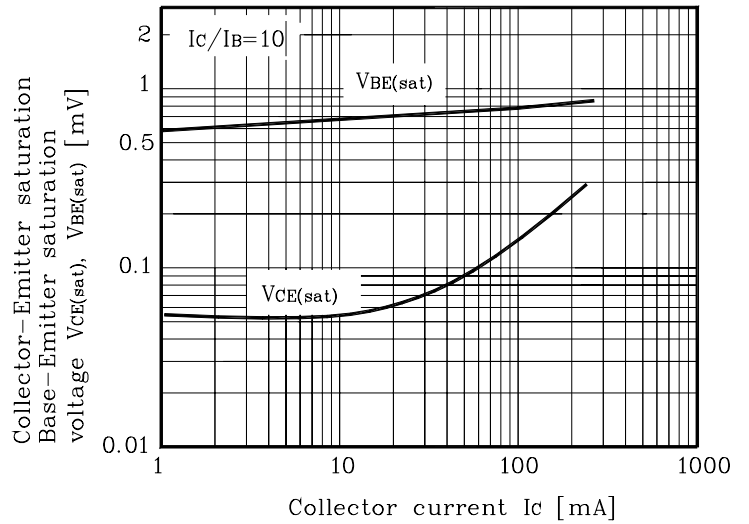
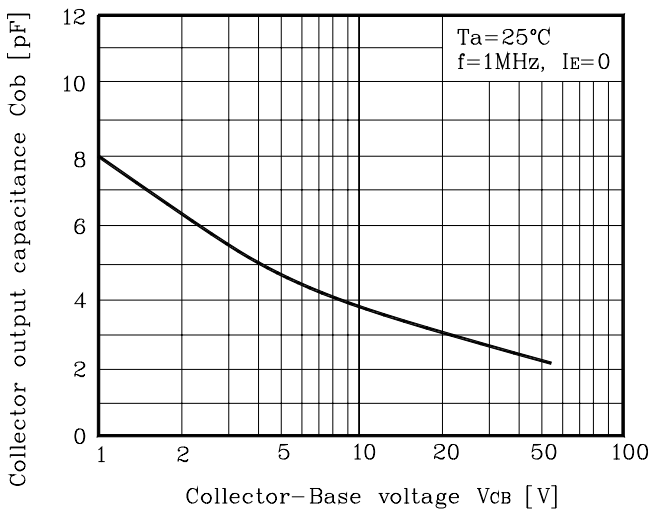
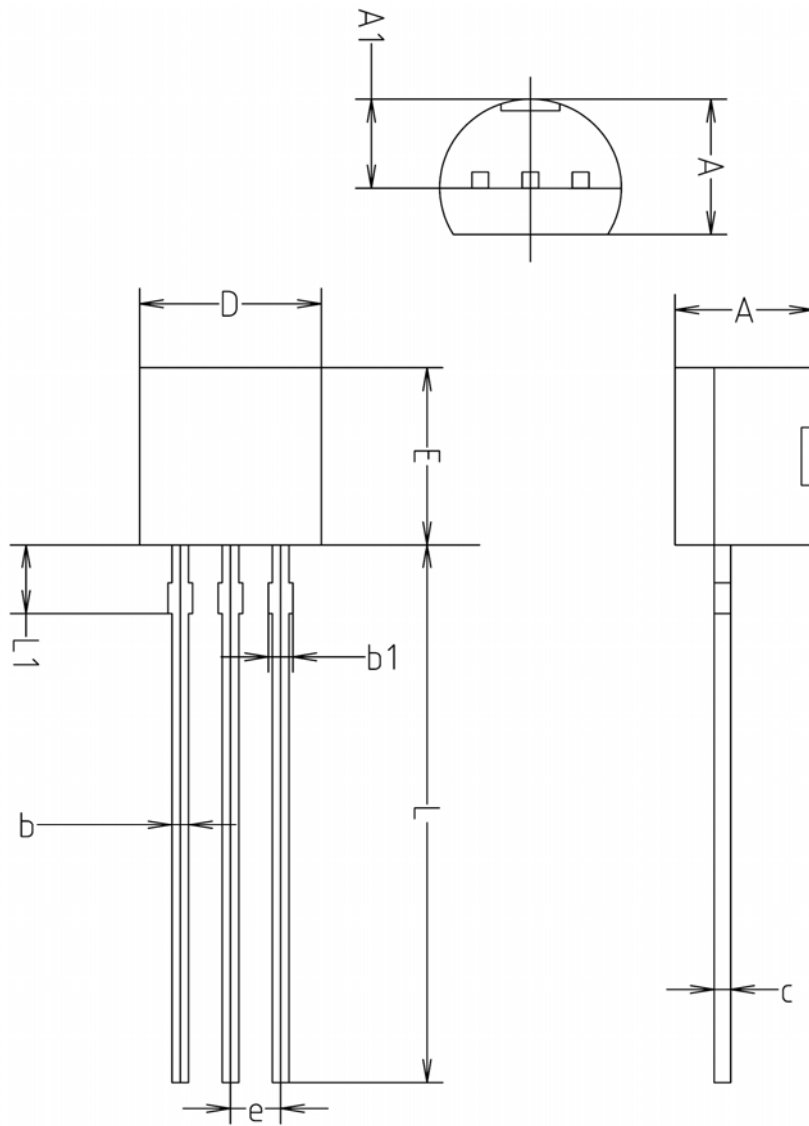

Fig. 5  $C_{ob} - V_{CB}$



Outline Dimension



SYMBOL	MILLMETERS(mm)		
	MINIMUM	NOMINAL	MAXIMUM
A	3.40	3.50	3.66
A1	2.46	2.51	2.59
b	0.39	0.44	0.53
b1	0.39	—	0.63
c	0.35	0.42	0.47
D	4.48	4.60	4.70
E	4.48	4.60	4.70
e	1.17	1.27	1.37
L	13.70	14.00	14.77
L1	1.55	1.70	2.15

**The AUK Corp. products are intended for the use as components in general electronic equipment (Office and communication equipment, measuring equipment, home appliance, etc.).**

**Please make sure that you consult with us before you use these AUK Corp. products in equipments which require high quality and / or reliability, and in equipments which could have major impact to the welfare of human life(atomic energy control, airplane, spaceship, transportation, combustion control, all types of safety device, etc.). AUK Corp. cannot accept liability to any damage which may occur in case these AUK Corp. products were used in the mentioned equipments without prior consultation with AUK Corp..**

**Specifications mentioned in this publication are subject to change without notice.**