

IL91214A/B

Tone/Pulse Dialer with Flash Function

IL91214A and IL91214B are tone/pulse dialers designed for providing standard DTMF or pulse signals. The ICs enable to:

- generate standard DTMF or pulse signals of dialing as well as “flash” pulses;
- store and redial last number;
- generate pause in the transmitted package of dial signals;

ICs are designed to be used in telephone sets.

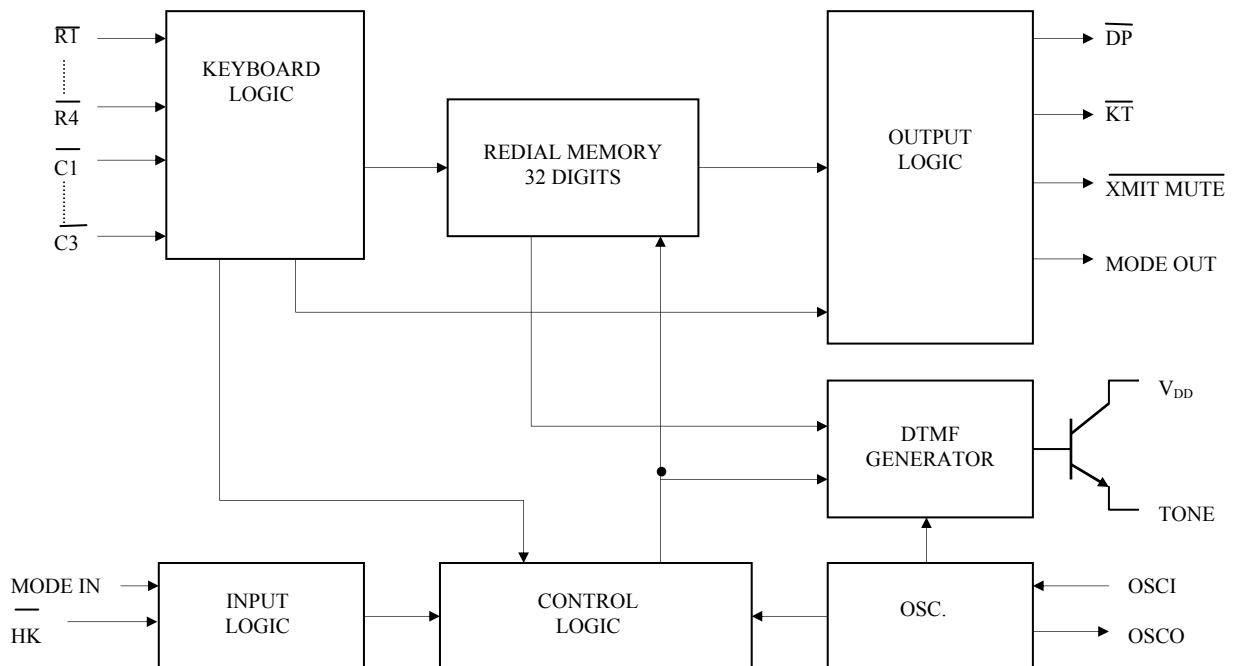
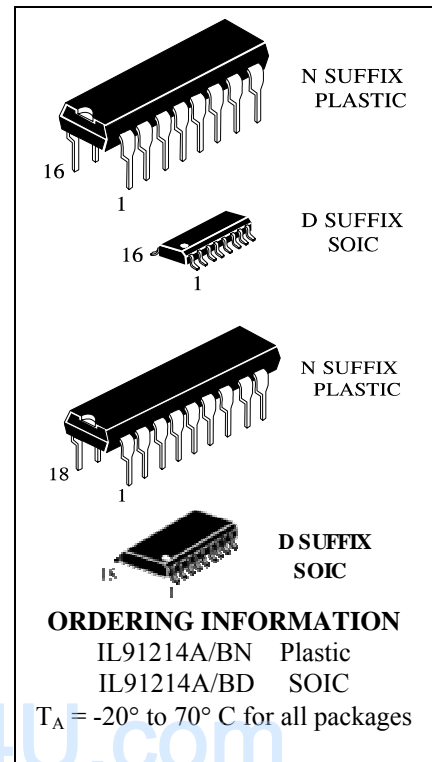

PIN DESCRIPTION

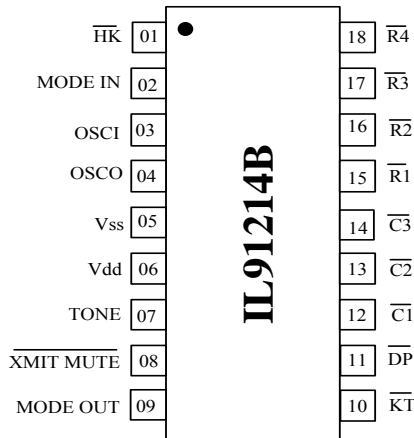
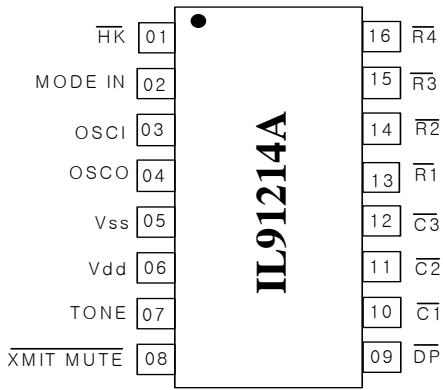

Pin #		Designation	Description
A	B		
1	1	HK	Hook switch input
2	2	MODE IN	MODE IN = V _{DD} : pulse mode, 10 Hz, M/B = 1/2,
			MODE IN = V _{SS} : tone mode, MODE IN = floating mode, 20 Hz, M/B = 1/2
3	3	OSCI	Oscillator input
4	4	OSCO	Oscillator output
5	5	V _{SS}	Ground
6	6	V _{DD}	Supply output
7	7	TONE	Tone dialing output
8	8	XMIT MUTE	Dialing transmission mute output
	9	MODE OUT	Mode output pin
	10	KT	Key-in tone output
9	11	DP	Dialing pulse output
10	12	C1	Keyboard column input
11	13	C2	Keyboard column input
12	14	C3	Keyboard column input
13	15	R1	Keyboard row input
14	16	R2	Keyboard row input
15	17	R3	Keyboard row input
16	18	R4	Keyboard row input

Keyboard Assignment

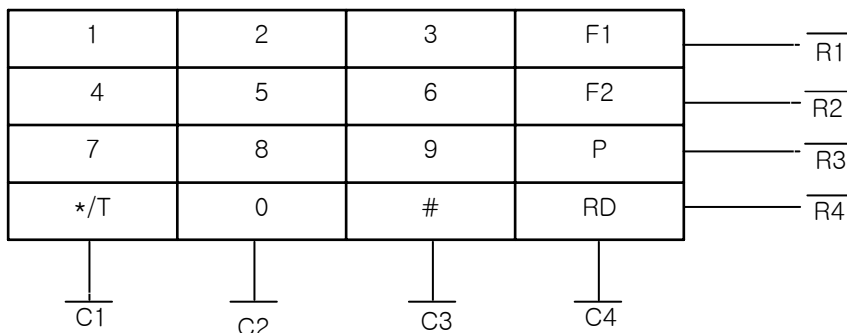

1. */T – At Pulse mode this key works as Pulse -> DTMF key (T key), at DTMF mode the key works as *key. */T key will occupy one memory digit in either use.
2. F1 – Flash key. The break time is 297ms
3. F2 – Flash key for break time 640ms
4. P – Pause key (2.2 seconds)
5. RD – One key redial key
6. # - At pulse mode this key input is neglected, at DTMF mode this key works as # key.

Description of Operation

In the description below, signals are defined in terms of the key or switch which is activated.

- Off Hook** means the phone was taken off the hook.
- On Hook** means that the receiver is on the hook.
- D1** stands for the first digit dialed in a string of digits.
- Dn** stands for the last digit dialed in a string of digits.
- Dn+1** stands for the beginning of a new string of digits.
- Dn+m** stands for the last digit in a new string of digits.
- HFI** stand for the switch that activates the Hands Free dialing mode going low.
- *T** is the Pulse-to-DTMF key.
- RD** is the Redial key.

- 0** is the Zero key.
- P** is the Pause key.
- F** is the Flash key.

1. Pulse mode operation

- a. **Off Hook** **D1** **Dn**

Pulse mode is defined as the initial mode, provided the first keyboard input is not the ***T** key following the **Off Hook** condition and the mode selection pin is floating (MODE IN = V_{DD} or floating)

- b. **On Hook** **HFI** **D1** **Dn**

Pulse mode is defined as the initial mode, provided the key input **D1** is not ***T** while the mode selection pin is V_{DD} or floating. The chip will pause for 824 ms automatically after it detects an **Off Hook** condition or the **HFI** key is depressed. It then proceeds with pulse or DTMF dialing if any keys have been depressed.

The dialing rate or make/break ratio is decided at the first key entry by checking the MODE IN status and will not be altered. The MODE IN status can only switch the dialing mode from Pulse to DTMF after the first key entry.

2. DTMF mode operation

- a. **Off Hook** **D1** **Dn** or **On Hook** **HFI** **D1** **Dn**

DTMF mode is defined as the initial mode of the mode selection pin MODE IN is V_{SS}.

- b. **Off Hook** ***T** **D1** **Dn** or **On Hook** **HFI** ***T** **D1** **Dn**

The initial mode is pulse mode if the mode selection pin, MODE IN, is V_{DD} or floating. The ***T** key can switch the dialing mode to tone mode. Unlike normal mode switching, the ***T** key entry, as the first key pressed, will not produce any pause time. There are only 31 digits of redial memory available in the buffer to be used for operations a and b, since the mode switching key, ***T**, will occupy one digit of space.

3. Manual dialing with automatic access pause

- Off Hook** **0** **P** **D1** **Dn**

Pause key entries can be accepted and stored in the redial memory. Each is stored as a digit. Each key-in will provide a pause of 3.57 seconds, depending on which model you are using

4. Redial

- a. **Off Hook** **RD** or **On Hook** **HFI** **RD**

Up to 32 digits (in pulse mode) or 31 digits (in tone mode) can be dialed using the **RD** key. The **RD** key is disabled while pulse or tone signals are being transmitted. Redial will also be inhibited if the last number dialed exceeds 32 digits because the redial memory can only hold 32 digits.

- b. **Off Hook** **RD** **D1** **Dn** or **On Hook** **HFI** **RD** **D1** **Dn**

After pressing the **RD** key, we can add digits to the number in redial memory. When finished dialing, the redial memory will contain the original digits plus the digits dialed after pressing **RD**. Each time the redial key is pressed, the stored number will be dialed exactly the same as it was previously, regardless of the status of the MODE IN pin.

5. TONE/PULSE switching operation

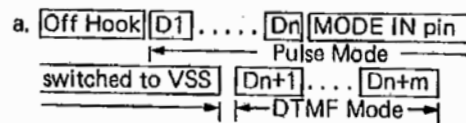

The mode selection pin is always checked for tone or pulse mode key entry. Dialing can be switched from pulse to tone mode, but not from tone to pulse mode. Switching the MODE IN pin to V_{SS} will cause the chip to store a ***T** digit prior to the first tone digit in the redial me-

memory and will automatically insert a 2.2 second pause before the tone digits are dialed out. After the mode has been switched, the status of the mode selection pin will no longer be checked. Therefore, it will not be possible to switch from tone to pulse mode.

- b. **Off Hook** **D1** **Dn** ***T** **Dn+1** **Dn+m**

Pulse mode is initially defined with the mode selection pin, MODE IN, equal to V_{DD} or floating. At this time, the mode can be switched to DTMF by pressing the ***T** key. DTMF mode will begin as soon as the last pulse has been transmitted. In this mode, **Dn+1** through **Dn+m** are sent through the TONE OUT pin as DTMF signals. If a **P** key entry is contained in the series of digits before or after the ***T** entry, or the MODE IN switch is depressed, 2.2 second pause will be added to the automatically inserted pause time, which is also 3.57 seconds. Both of the above switching modes can store as many as 31 digits in the redial memory.

6. One-Key redialing

Off Hook [D1] [Dn] [RD] or
 On Hook [HFT] [D1] [Dn] [RD]

If the dialing of [D1] to [Dn] is finished, pressing [RD] will cause the pulse dialing pin to go low for 2.2 seconds of break time and an 824 ms pause will automatically be added. If the pulses of the number dialed with [D1] to [Dn] have not finished, the pressing of the redial key will be ignored.

7. Flash dialing

Off Hook [F] [D1] [Dn] or
 On Hook [HFT] [F] [D1] [Dn]

The flash keys emulate quick On-Off Hook operations. Pressing the flash keys, [F1] or [F2], will cause a break of 96 ms or 640 ms (or, 297 ms or 640 ms, depending on the model) on the \overline{DP} output pin. Then, it pauses for 824 ms and continues dialing the digits, [D1] to [Dn]. These digits are then stored in the redial memory.

Each time the flash key is pressed, the redial memory will be cleared to store a new entry. In addition, the MODE IN status will be checked again for the setting of the Tone/Pulse dialing mode.

Similarly, to make sure that the IC is working properly, new flash key inputs will be ignored as long as the digits that were dialed have not finished.

DC electrical characteristics

($V_{DD} = 3.5\text{ V}$, $V_{SS} = 0\text{ V}$, $F_{OSC} = 3.579\text{ MHz}$, $T = 25^\circ\text{C}$, unless otherwise specified)

Parameter	Symbol	Min.	Typ	Max.	Condition	
Supply voltage, V	V_{DD}	2.0		5.5	Pulse mode	
		2.0		5.5	Tone mode	
Memory retention voltage, V	V_{MR}	1				
Memory retention current, μA	* I_{MR}		0.05	0.4	$V_{DD} = 1.0\text{ V}$ $HK = V_{DD}$	All outputs unloaded
Operation current, mA	I_{DDP}		0.32	1.0	Pulse	
	I_{DDT}		0.6	2.0	Tone	
Standby current, μA	* I_{SO}		0.03	0.05	$\overline{HK} = V_D$ D	All outputs unloaded. No key selected. $V_{DD} = 1.5\text{ V}$
			0.5	10	$\overline{HK} = V_{SS}$	
Input voltage, V	V_{IH}	$0.8 V_{DD}$		V_{DD}	$V_{DD} = 3.5\text{ V}$	
	V_{IL}	0		$0.2 V_{DD}$		
Input current R1-R4, μA	I_R		115			
Tone out voltage, mV	V_{OC}	584	730	876	Column	$V_{DD} = 3.5\text{ V}$ $R_L = 5\text{ K}$
	V_{OR}	456	570	684	Row	
Sink current XMUTE, mA	I_{OL1}	0.9	5.3		$V_{DD} = 3.5\text{ V}$, $V_{OL} = 0.4\text{ V}$	
Sink current DP, mA	I_{OL2}	1.1	5.3		$V_{DD} = 3.5\text{ V}$, $V_{OL} = 0.4\text{ V}$	
Distortion, %	DIS %		1	5		

* - in this mode IC functioning is not guaranteed.

AC characteristics

($V_{DD} = 3.5\text{ V}$, $V_{SS} = 0\text{ V}$, $F_{OSC} = 3.579\text{ MHz}$, $T = 25^{\circ}\text{C}$, unless otherwise specified)

Parameter	Symbol	Min.	Typ	Max.	Condition	
					Dialing speed, pps	
Make time, ms	T_M		33.3		10	M/B=1/2
			16.7		20	M/B=1/2
Break time, ms	T_B		66.6		10	M/B=1/2
			33.3		20	M/B=1/2
Inter-digit pause time, ms	T_{IDP}		824		10 pps	
			458		20 pps	
Pause time, s	T_{PAU}		2.2			
Auto-redial break time, s	T_{AOBK}		2.2			
Delay time key valid to signal out, ms	T_D		0			
Key-in debounce, ms	T_{KD}		21			
Key-in tone duration, ms	T_{KTD}		23			
Key-in tone frequency, Hz	F_{KT}		437			
Minimal tone duration time, ms	T_{MFD}		94			
Minimum tone inter-digit pause, ms	T_{TIDP}		96			
Redial tone duration, ms	T_{MFDR}		94			
Redial tone inter-digit duration, ms	T_{TIDPR}		96			

Values of generated frequencies

R/C	Frequency	Error, %	Unit	Conditions
$\overline{R1}$	697	+ 0.31	Hz	FOSC = 3.579 MHz
$\overline{R2}$	770	+ 0.19	Hz	
$\overline{R3}$	852	+ 0.03	Hz	
$\overline{R4}$	941	+ 0.10	Hz	
$\overline{C1}$	1.209	+ 0.57	Hz	
$\overline{C2}$	1.336	- 0.32	Hz	
$\overline{C3}$	1.477	- 0.35	Hz	

Absolute maximum ratings

Parameter		Absolute maximum value
Supply voltage	V_{DD}	$\leq 6.0\text{V}$
Input voltage	V_{IN}	$V_{SS}-0.3\text{V} \sim V_{DD}+0.3\text{V}$
Output voltage	V_{OUT}	$V_{SS}-0.3\text{V} \sim V_{DD}+0.3\text{V}$
Output voltage (DP, XMIT MUTE).	V_{OUT}	$\leq 1.2\text{V}$
Tone output current	I_{TONE}	$\leq 50\text{ mA}$
Power dissipation	P_D	$\leq 500\text{ mW}$
Storage temperature	T_{STG}	$-40^{\circ}\text{C} \sim +125^{\circ}\text{C}$

1. Pulse dialing mode.

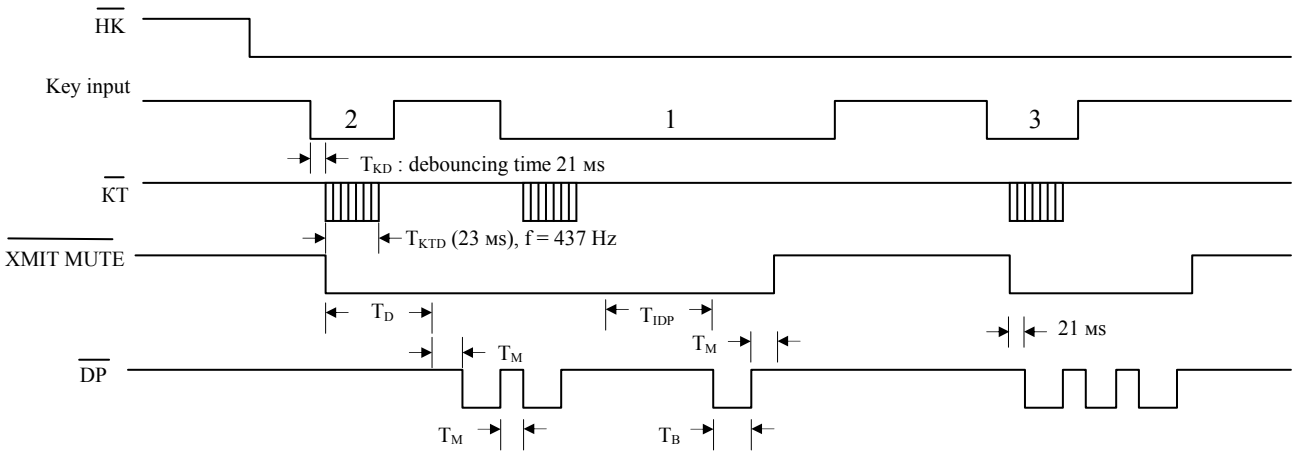

2. Tone dialing mode.

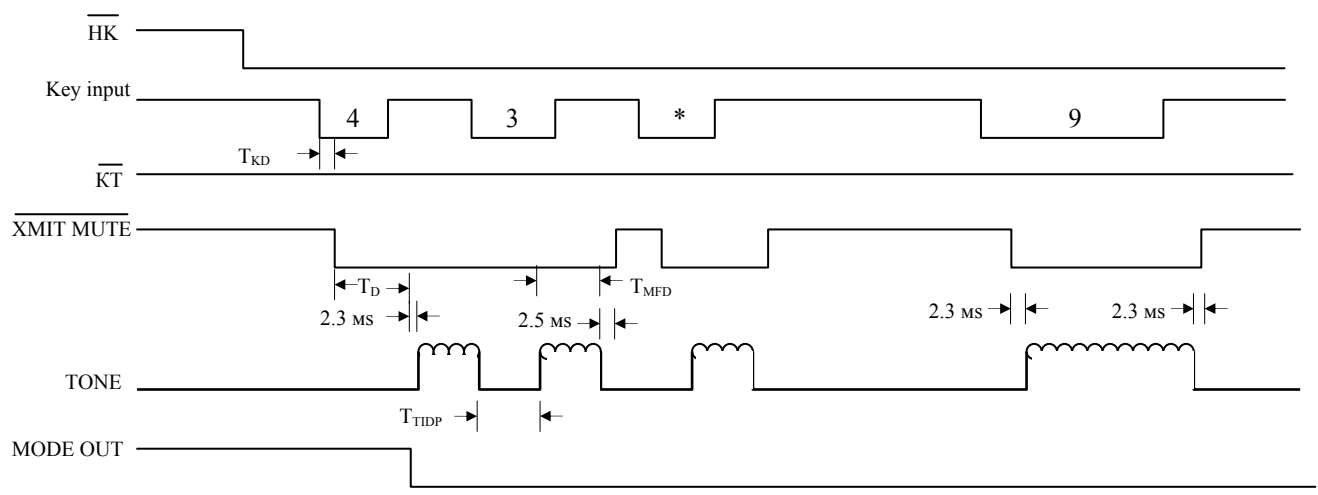

3. Redialing.

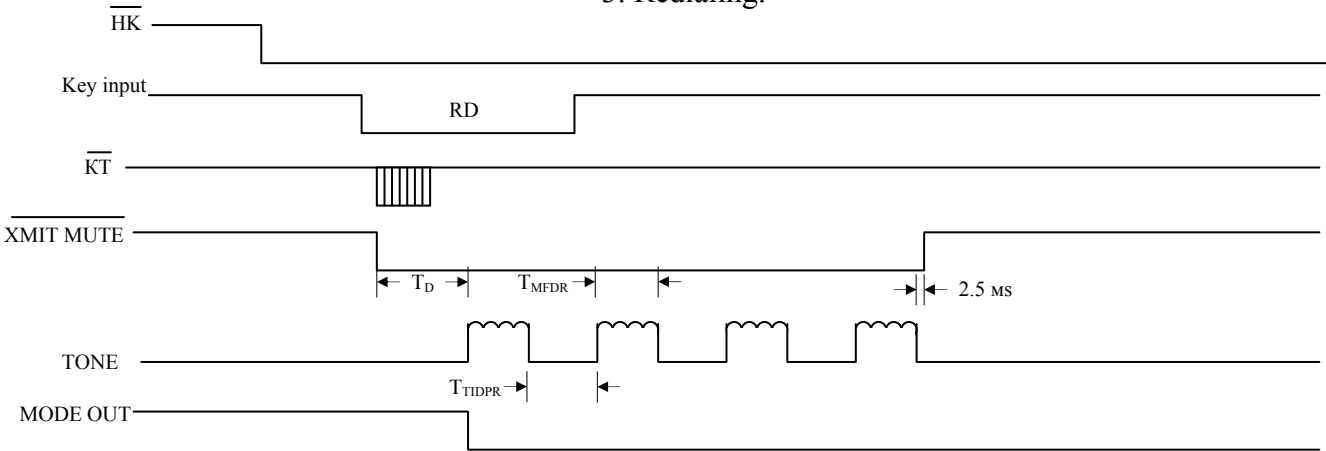

4. Switching mode operation (MODE IN control).

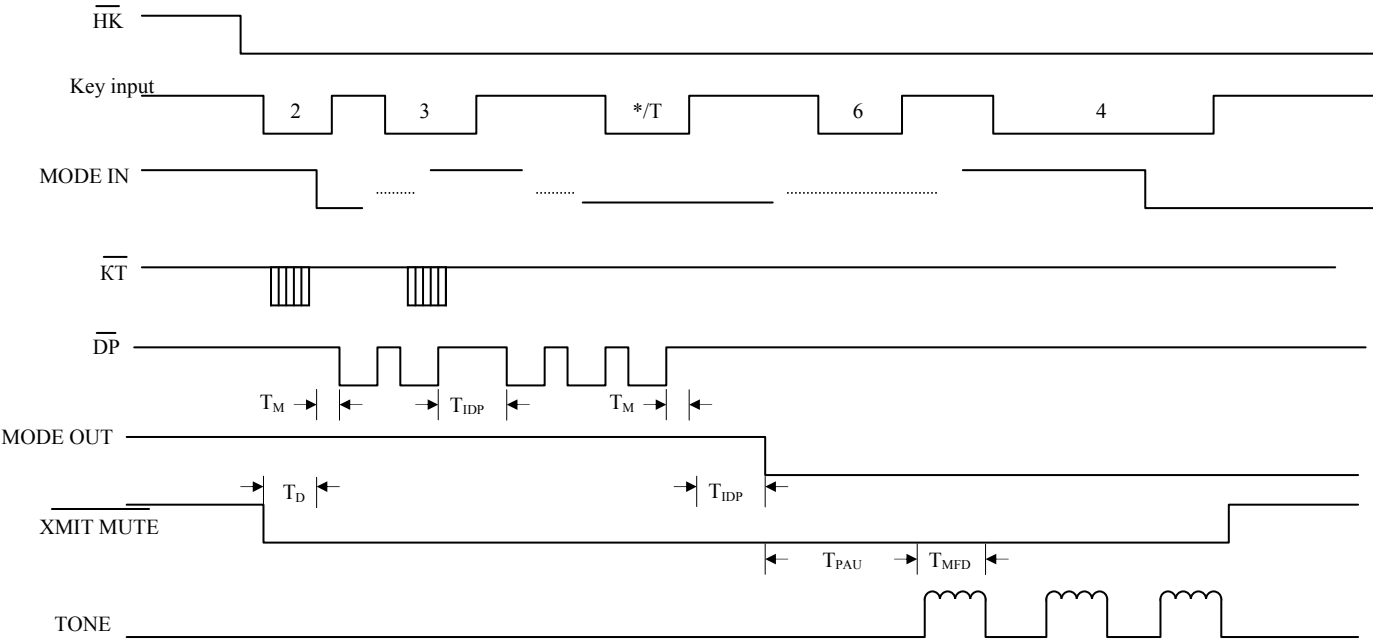

5. Switching mode operation (* / T key entry).

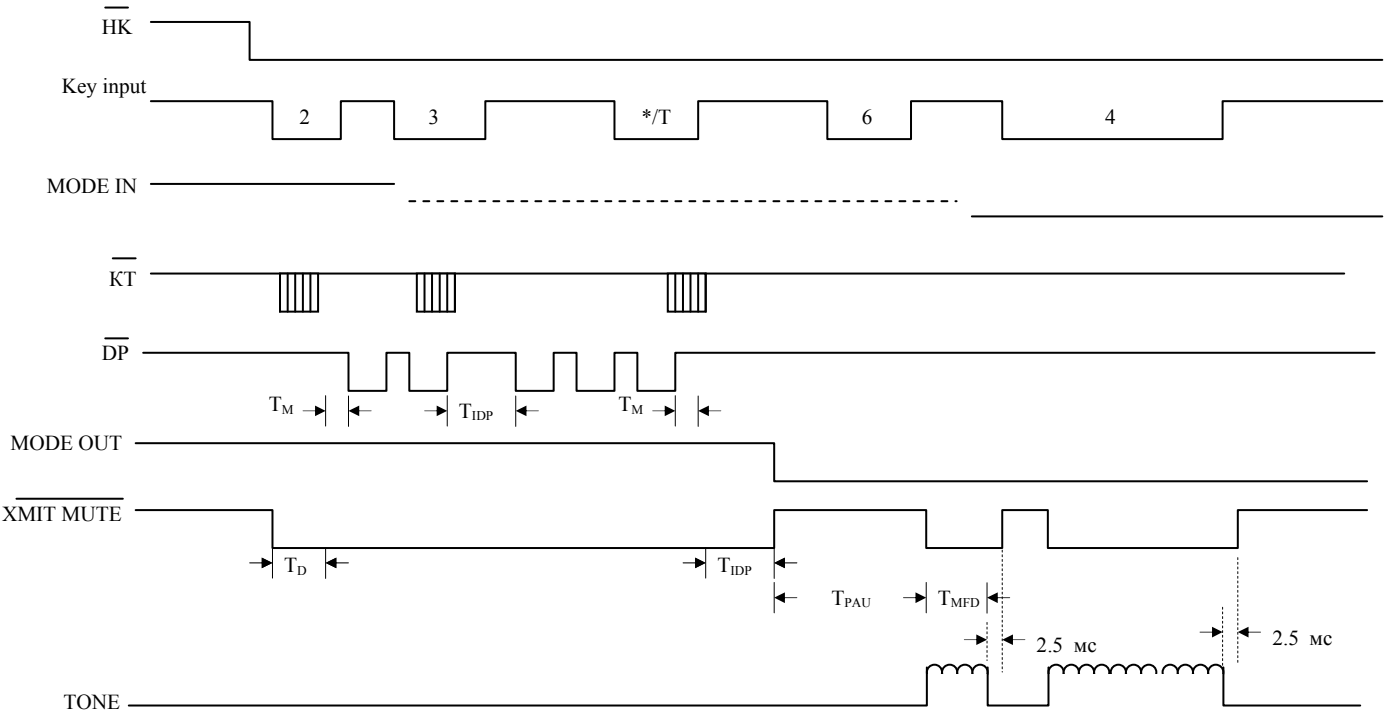

6. One key redial using RD key (DTMF mode for example).

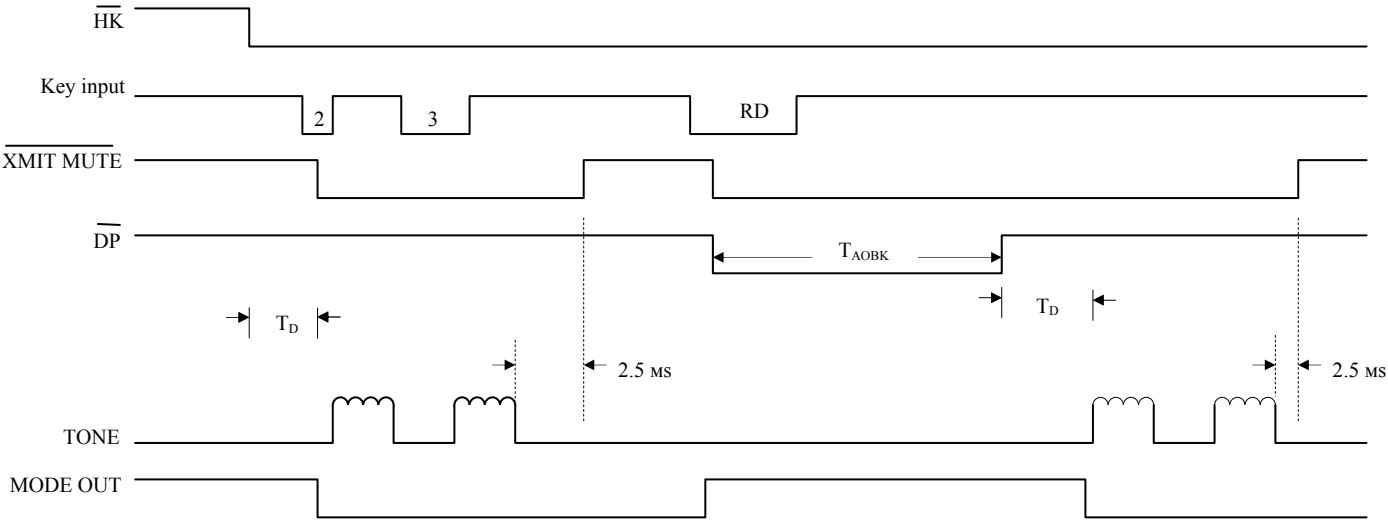

7. Flash dialing

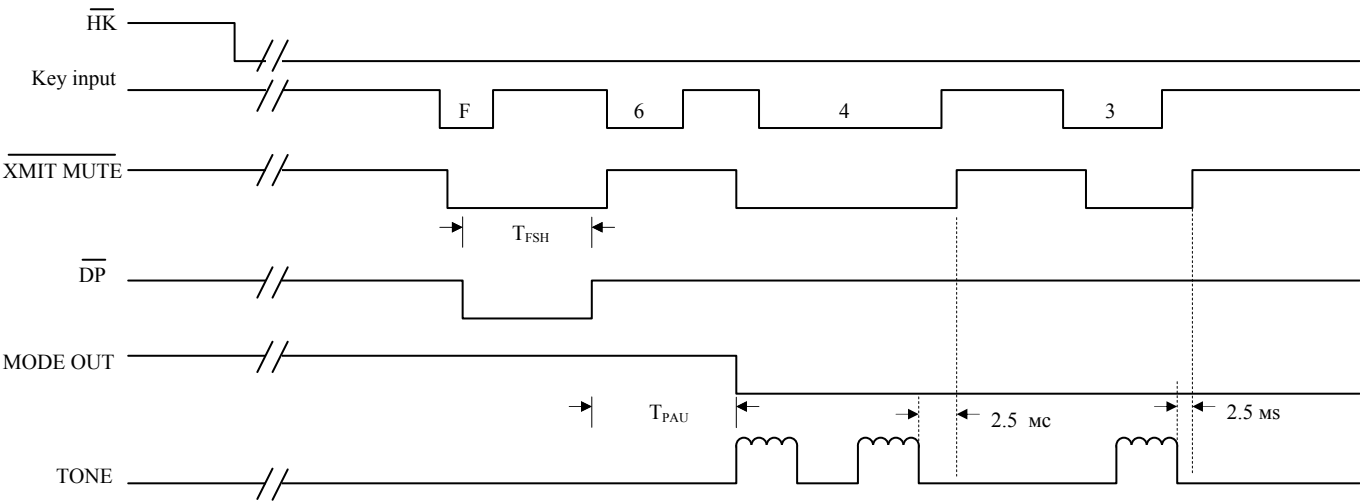

**N SUFFIX PLASTIC DIP
(MS - 001BB)**

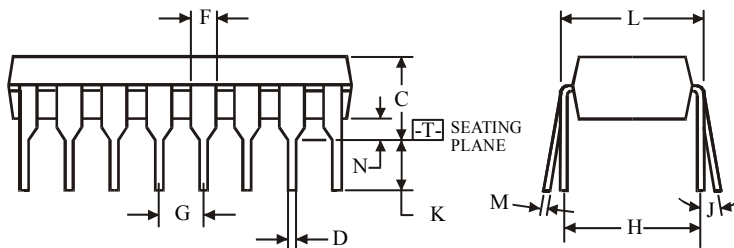
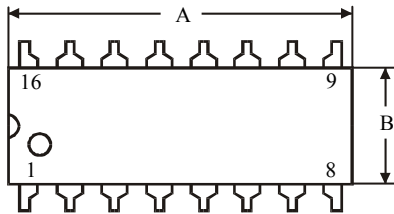
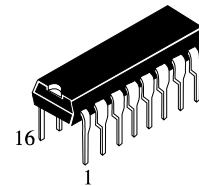

$\oplus 0.25 (0.010) \text{ (M) T}$

NOTES:

- Dimensions "A", "B" do not include mold flash or protrusions.
Maximum mold flash or protrusions 0.25 mm (0.010) per side.

Symbol	Dimension, mm	
	MIN	MAX
A	18.67	19.69
B	6.1	7.11
C		5.33
D	0.36	0.56
F	1.14	1.78
G	2.54	
H	7.62	
J	0°	10°
K	2.92	3.81
L	7.62	8.26
M	0.2	0.36
N	0.38	

**D SUFFIX SOIC
(MS - 012AC)**

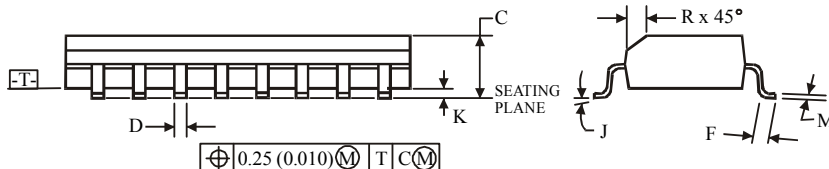
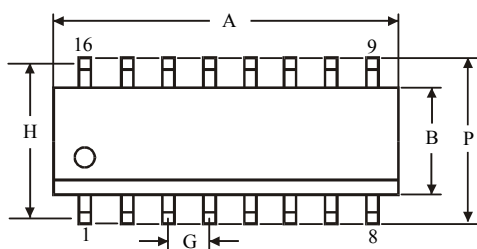
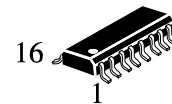

$\oplus 0.25 (0.010) \text{ (M) T C (M)}$

NOTES:

- Dimensions A and B do not include mold flash or protrusion.
- Maximum mold flash or protrusion 0.15 mm (0.006) per side for A; for B - 0.25 mm (0.010) per side.

Symbol	Dimension, mm	
	MIN	MAX
A	9.8	10
B	3.8	4
C	1.35	1.75
D	0.33	0.51
F	0.4	1.27
G	1.27	
H	5.72	
J	0°	8°
K	0.1	0.25
M	0.19	0.25
P	5.8	6.2
R	0.25	0.5

**N SUFFIX PLASTIC DIP
(MS - 001AC)**

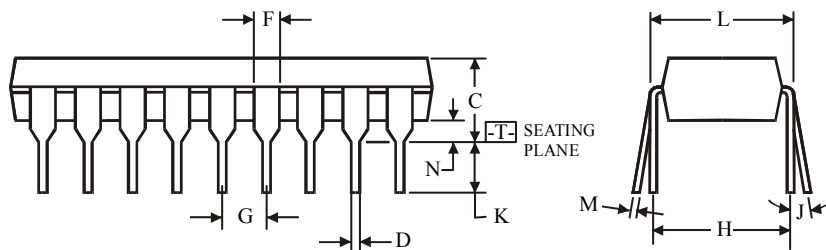
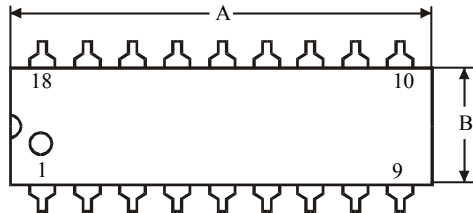
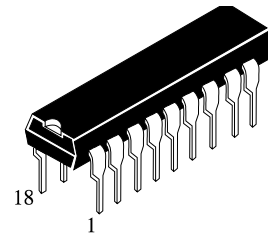

$\oplus 0.25 (0.010) \text{M} \text{ T}$

NOTES:

- Dimensions "A", "B" do not include mold flash or protrusions.
Maximum mold flash or protrusions 0.25 mm (0.010) per side.

Symbol	Dimension, mm	
	MIN	MAX
A	22.35	23.37
B	6.1	7.11
C		5.33
D	0.36	0.56
F	1.14	1.78
G	2.54	
H	7.62	
J	0°	10°
K	2.92	3.81
L	7.62	8.26
M	0.2	0.36
N	0.38	

**D SUFFIX SOIC
(MS - 013AD)**

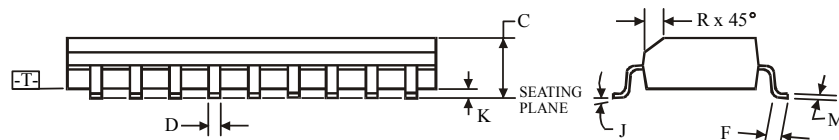
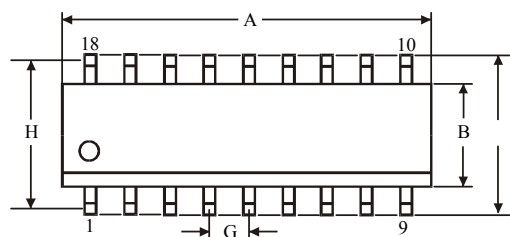
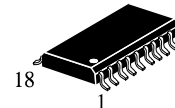

$\oplus 0.25 (0.010) \text{M} \text{ T} \text{ C} \text{ M}$

NOTES:

- Dimensions A and B do not include mold flash or protrusion.
- Maximum mold flash or protrusion 0.15 mm (0.006) per side for A; for B - 0.25 mm (0.010) per side.

Symbol	Dimension, mm	
	MIN	MAX
A	10.1	10.5
B	7.4	7.6
C	2.35	2.65
D	0.33	0.51
F	0.4	1.27
G	1.27	
H		
J	0°	8°
K	0.1	0.3
M	0.23	0.32
P	10	10.65
R	0.25	0.75